

YAESU

The radio

FTM-100DR

Operating Manual

**144/430MHz
DUAL BAND TRANSCEIVER**

C4FM/FM



Before Use

Installation and Connection

Basic Operations

Using the Memory

Scanning

Using the GPS Function

Using the APRS Function

Using the GM Function

Using the WIRES-X Function

Convenient Functions

Functions to Use as Necessary

**Customizing Menu Settings and
User Preferences**

**Using the Optional Accessories
(Bluetooth Devices/Voice Unit)**

Appendix

Features of this transceiver

- 144/430 MHz dual-band transceiver equipped with standard C4FM digital communication modulation
 - Clear audio and data communication are achieved using the digital modulation functions
 - Wide-band receives in the 108 MHz to 999 MHz range (air band, information wireless band)
 - Transmit power 50 watts with cooling fan
 - The dot matrix LCD is mounted on the front panel
 - 500 memory channels in the A-band and 500 channels in the B-band
 - Your frequency memory channels and transceiver configuration settings can be backed up using a microSD memory card. The data on the microSD memory card can easily be copied to other transceivers
 - A choice of scanning functions (including VFO scan, memory scan)
 - Built-in GPS receiver unit displays your station location and movement information. Connection to external GPS devices is enabled.
 - Incorporated APRS® function enables data communication of location information and messages
 - *Refer to the separate “APRS Instruction Manual”
 - GM (Group Monitor) function in which frequently communicating members can be registered as a group, thereby allowing location information and messages to be exchanged
 - *Refer to the separate “GM Instruction Manual”
 - Supports Yaesu WIRES-X Internet linking, enabling communication with remote partners via the Internet
 - *Refer to the separate “WIRES-X Instruction Manual”
 - Bluetooth adaptor unit BU-2 (sold separately) permits hands-free operation
 - Voice guide unit FVS-2 (sold separately) provides voice announcements and recording of received audio
- * The WIRES-X, APRS, and GM Instruction Manuals are not included with this product. Please download them directly from the Yaesu website.

Important precautions for mobile transceiver operation

- The use of protective tape or covering is recommended to protect the wiring and the power cord inside the vehicle. If precautions are not taken, the power cord may rub against sheet metal causing the wires beneath the cable sheathing to become exposed resulting in fire or equipment failure.
- Install the antenna and co-axial cable, which radiate radio waves, away from the control unit and wiring harness.
- When installing the unit inside a vehicle, position the transceiver, antenna, and co-axial cable at least 20 cm away from the following equipment:
 - **Engine related:** Fuel injection equipment and engine control unit (gasoline-powered vehicles) or glow control unit (diesel-powered vehicles)
 - **Transmission-related:** Electronic control transmission and 4WD control unit
 - **Others:** ECS/EPS/ABS/ETACS/Fully automatic air-conditioner/ Auto-heater control unit/G sensor
- When installing the transceiver or a separately sold product, place all cables so they do not entangle or impede the driver or passengers.
- When installing the transceiver or a separately sold product, never install in a location where it may pose a danger to the passengers, where it may interfere with driving, or obstruct the driver field of view.
Failing to take precautions accordingly may result in a vehicle accident.
- When installing the transceiver or a separately sold product in a vehicle with air bags, avoid installing it in a way that it may interfere with proper operation of the air bags.
- After installing the transceiver in the vehicle, check that, for example, the brake lamp, head lamp, turning indicator lights, and wipers are functioning properly while the transceiver power is switched on.
- When using the transceiver, if it appears to have abnormal effects on the control equipment of the vehicle, stop the engine, turn off the power supply, and disconnect the power cord.
- Keep full attention on driving and refrain from operating the transceiver controls or looking at the transceiver while driving.
Always stop the vehicle at a safe location before operating the transceiver controls or looking at the display.
- Do not drive the car in such a way that external sounds required for safe driving cannot be heard. Most areas and states prohibit the use of earphones and headphones while driving.
- When using the transceiver in an electric or hybrid vehicle, noise from the inverter built into the electric or hybrid vehicle may cause interference to reception.

About registered trademarks and copyrights

APRS is a registered trademark of Mr. Bob Bruninga WB4APR.

SmartBeaconing is supplied by HamHUD Nichetronix.

Microsoft, Windows and Windows Vista are registered trademarks of Microsoft Corporation in the United States and other countries.

Bluetooth® is a registered trademark of the Bluetooth SIG.

Other company and product names listed in this manual are trademarks and registered trademarks of their respective companies.

Unauthorized reproduction or copying of a part or all of the copyrights owned by Yaesu Musen Co., Ltd. in any form whatsoever is strictly prohibited.

How to read this manual

In this manual, front panel operations are described as follows.

Press  Indicates that the key or switch is to be pressed briefly.

Press  for over one second.... Indicates that the key or switch is to be pressed for over one second.

The following symbols are also used in this manual:

Caution  ...Explains caution to observe during operation.

Tip  ...Explains operating suggestions or useful tips.

Also note: the actual product may differ from the drawings shown in this manual.

Contents

Introduction	2	Selecting communication mode	39
Features of this transceiver	2	Switching the modulation mode	40
Important precautions for mobile transceiver operation	3	Communicating	41
About registered trademarks and copyrights	4	Transmitting	41
How to read this manual	5	Adjusting the transmit power	42
Before Use	9	Adjusting the microphone sensitivity	42
Safety Precautions (make sure to read these)	9	Communicating in FM mode	43
Checking the supplied items	13	Communicating using the repeater	43
Name and function of each component	14	Changing the 100.0 Hz CTCSS tone squelch	44
Front panel	14	Other settings	45
Front	14	Changing the beep volume	45
Rear	16	Locking the DIAL and keys	46
Main body	16	Adjusting the date and time	46
Front	16	Adjusting the display brightness	48
Rear	17	Restoring defaults (All Reset)	49
Microphone (MH-48A6JA)	18	Using the Memory	51
Screen display	19	Registering to the memory channel	51
Input characters	20	Recalling memories	52
Switching the character type	20	Recalling the home channel	53
Deleting the input characters	20	Changing the frequency of the home channel	54
Moving the cursor to the left	20	Clearing memories	55
Moving the cursor to the right	20	Naming a memory channel	56
Deleting the most recently input character	20	Displaying the memory tag	58
Completing input	20	Split memory	59
Installation and Connection	21	Receiving Weather Broadcast Channels (USA version only)	60
Installing the transceiver	21	Assigning the "WX" function to a programmable key on the microphone	60
Precautions on installation	21	Recalling the weather channels	60
Installation location when used in a mobile unit	22	Listening the weather alert	61
About the antenna	23	Scanning	62
Installing the antenna	23	Searching for signals	62
Installing the main body	25	VFO scan	62
Installing the front panel	26	Selecting the receiver operation performed after scanning stops	63
Connecting the transceiver	27	Memory scan	64
Connecting the front panel to the main body	27	Selecting the scanning method	65
Connecting the microphone	27	Specifying memory channels	66
Connecting the antenna	27	Scanning only the specified memory channels	67
Connecting the power supply	28	Setting memories to skip	67
Connecting the car battery	28	Scanning the programmable memories (PMS)	68
Connecting the external power supply equipment	30	Registering to the programmable memory channels	68
Preparing a microSD memory card	31	Scanning the programmable memory channels	69
microSD cards supported by the transceiver	31	Monitoring the home channel	70
Notes on using microSD memory cards	31	Using the dual receive function	70
Inserting a microSD memory card	32	Setting the dual receive restart setting	71
Removing the microSD memory card	32	Setting the channel signal reception time when using the dual reception function	71
Initializing microSD memory cards	33	Using the GPS Function	72
Basic Operations	34	What is GPS?	72
Receiving	34	Activating the GPS function	72
Turning the power on	34	Checking the satellite acquisition status	73
Switching the power off	34	Displaying the location information	74
Inputting the call sign	34		
Toggling the operating band	35		
Adjusting the volume level	35		
Adjusting the squelch level	36		
Tuning in to the frequency	37		
Changing the frequency steps	37		
Switching the operation mode	38		

Displaying your current location information ... 74

Displaying location information of the received station in digital mode 74

Saving location information (GPS Log Function) 74

 Checking the route using a personal computer 75

 Other settings 76

Using the APRS Function 77

What is the APRS (Automatic Packet Reporting System) function? 77

Using the GM Function 78

What is the GM (Group Monitor) Function? 78

How to use the GM function 78

Using the WIRES-X Function 80

What is the WIRES-X Function? 80

Convenient Functions 81

Communicating with specific stations 81

 Using the tone squelch function 81

 Selecting the tone frequency 81

 Using the tone squelch function 82

 Transmitting tone signals 83

 Using the digital code squelch function 84

 Selecting the DCS code 84

 Using the DCS function 85

 Using the new pager function 86

 Setting the transceiver pager code 86

 Activating the new pager function 87

 Calling a specific station 88

 Notification of incoming calls from partner stations using the bell function 89

 Other squelch functions 90

Using the DTMF function 91

 Registering the DTMF code 91

 Transmitting the registered DTMF code 92

 Transmitting the DTMF code manually 92

Using the timer function 94

 Using the APO function 94

 Using the TOT function 95

Exchanging messages or images 96

 Viewing the message or image list 96

 Deleting messages or images 97

 Deleting data from the content display screen 97

 Deleting data from the list 98

 Downloading messages or images 98

 Sending messages or images 99

 Creating and sending a new message 99

 Using routine message 100

 Replying to the sender of the downloaded message or image data 102

 Forwarding the downloaded message or image data 103

Functions to Use as Necessary 104

Copying the radio data to another transceiver 104

 Using a microSD memory card 104

 Copying data to a microSD memory card 104

 Copying data from the microSD memory card 105

 Using the clone function 106

Connecting an external device 108

 Connecting to a computer 108

 Transmitting GPS location information 109

 Updating the transceiver firmware 110

Using the transceiver for packet communications 111

 Other connectable devices 115

Customizing Menu Settings and User

Preferences 116

Setup menu basic operations 116

Setup-menu listing 117

Setup menu operations: 1 DISPLAY 123

 Setting up the screen display (1 SUB DISPLAY SELECT) 123

 Setting the display brightness (2 LCD BRIGHTNESS) 123

 Setting the display contrast (3 LCD CONTRAST) 123

 Switching the GPS information (4 GPS INFORMATION) 124

Setup menu operations: 2 TX/RX 125

 Setting the modulation mode (1 ANALOG MODE SELECT) 125

 Setting the microphone sensitivity (2 MIC GAIN) 125

 Setting the transmission mode when using the AMS function (3 AMS TX MODE) 125

 Setting the squelch type in digital mode (4 DIGITAL SQL TYPE) 126

 Setting the digital mode squelch code (5 DIGITAL SQL CODE) 127

 Setting the time to display the partner station information in a pop-up window (6 DIGITAL POPUP TIME) 128

 Setting your location information display (7 LOCATION SERVICE) 128

 Sounding a beep when a partner station ends a transmission (8 STANDBY BEEP) 129

 Using the half deviation function (9 HALF DEVIATION) 130

Setup menu operations: 3 MEMORY 130

 Setting the memory tag display (1 ALPHA TAG SIZE) 130

 Setting the memory scan method (2 MEMORY SCAN TYPE) 130

Setup menu operations: 4 SIGNALING 131

 Setting the tone frequency (1 TONE SQL FREQ) 131

 Setting the DCS code (2 DCS CODE) 131

 Setting the DTMF code transmission method (3 AUTO DIALER) 131

 Setting the squelch type (4 SQL TYPE) 131

 Registering the DTMF code (5 DTMF MEMORY) 131

 Calling only the specific stations (6 PAGER CODE) 131

Contents

Notification of calls from partner stations (8 BELL RINGER).....	131
Setting the squelch type separately for transmission and reception (9 SQL EXPANSION).....	132
Setting the weather alert operation (USA Version Only).....	132
Setup menu operations: 5 SCAN	133
Setting the signal reception method (1 DUAL WATCH STOP).....	133
Setting the scanning direction (2 SCAN DIRECTION).....	133
Selecting the receiver operation performed after scanning stops (3 SCAN RESUME).....	134
Setting the channel signal reception time when using the dual reception function (4 DUAL WATCH MODE).....	134
Setup menu operations: 6 GM.....	134
Setup menu operations: 7 WIRES-X.....	134
Setup menu operations: 8 CONFIG	135
Setting the date and time (1 DATE & TIME ADJUST).....	135
Setting the time display format (2 TIME FORMAT).....	135
Setting the time zone (3 TIME ZONE).....	136
Using the auto repeater shift function (4 AUTO REPEATER SHIFT).....	136
Setting the repeater shift direction (5 REPEATER SHIFT).....	137
Setting the repeater shift width (6 REPEATER SHIFT FREQ).....	137
Setting the frequency step (7 FM AM STEP).....	138
Setting the beep volume (8 BEEP).....	138
Setting the microcomputer clock shift (9 CLOCK TYPE).....	138
Setting the program keys on the microphone (10 MIC PROGRAM KEY).....	138
Expanding the reception range (11 RX COVERAGE).....	140
Setting the unit displayed on the screen (12 UNIT).....	140
Turning off the transceiver automatically (13 APO).....	141
Limiting the continuous transmission time (14 TOT).....	141
Setting the PIN code for the Bluetooth headset (15 Bluetooth PAIRING).....	141
Setting the geodetic reference system (16 GPS DATUM).....	141
Setting the interval for saving the GPS location information (17 GPS LOG).....	142
Setup menu operations: 9 DATA	143
Setting the COM port (1 COM PORT SETTING).....	143
Setting the APRS and data communication speed (2 DATA SPEED).....	145
Squelch detection and squelch jack output settings (3 DATA SQUELCH).....	146
Setup menu operations: 10 APRS.....	146
Setup menu operations: 11 SD.....	146
Copying the transceiver settings to a microSD memory card (1 BACKUP).....	146
Initializing a microSD memory card (2 FORMAT).....	146
Setup menu operations: 12 OPTION.....	147
Setting the Bluetooth headset operations (1 Bluetooth).....	147
Setting the voice memory operations (2 VOICE MEMORY).....	147
Setup menu operations: 13 RST/CLONE.....	147
Resetting the transceiver settings (1 FACTORY RESET).....	147
Presetting (2 PRESET).....	147
Recalling the preset setting (3 RECALL PRESET).....	148
Deleting the registered data from the memory channels (4 MEMORY CH RESET).....	148
Sorting the memory channels (5 MEMORY CH SORT).....	149
Resetting the APRS setting (6 APRS RESET).....	149
Copying the saved data (7 CLONE).....	149
Setup menu operations: 14 CALLSIGN.....	150
Changing the call sign (1 MY CALLSIGN (DIGITAL)).....	150
Using the Optional Accessories (Bluetooth Devices/Voice Unit)	151
Using the Bluetooth headset	151
Mounting the Bluetooth unit "BU-2".....	151
Setting the Bluetooth headset operations.....	153
Identifying the Bluetooth headset	155
Using the Bluetooth headset.....	157
Recording and listening to received audio.....	158
Mounting the voice guide unit "FVS-2".....	158
Using the voice memory	160
Setting the voice memory operation.....	160
Recording the received audio	161
Playing the recorded audio	162
Erasing the recorded audio	162
Activating the frequency voice announcement ..	163
Setting the announcement function operation	163
Activating to the frequency announcement ...	164
Appendix	165
Optional components.....	165
Maintenance.....	166
Care and maintenance.....	166
Replacing the fuse	166
Troubleshooting.....	167
There is no power	167
There is no sound	167
There is no transmission.....	167
The keys or knobs do not operate.....	167
About internal spurious signals.....	168
Specifications	169
Index	171

Safety Precautions (make sure to read these)

Make sure to read this manual in order to use this radio safely and correctly.

Before using this product, note that the company shall not be liable for any damages suffered by the customer or third parties, or for any failures and faults that occur during the use or misuse of this product, unless otherwise provided for under the law.

Type and meaning of the marks



DANGER

This symbol indicates the possibility of death or serious injury being inflicted on the user and the surrounding people when these instructions are ignored and the product is mishandled.



WARNING

This symbol indicates the possibility of death or serious injury being inflicted on the user and the surrounding people when these instructions are ignored and the product is mishandled.



CAUTION

This symbol indicates the possibility of physical impediments occurring or impediments being inflicted on the user and the surrounding people when these instructions are ignored and the product is mishandled.

Type and meaning of symbols



Prohibited actions that must not be attempted, in order to use this radio safely.

For example,  signifies that disassembly is prohibited.



Precautions that must be adhered to in order to use this radio safely. For example,  signifies that the power supply is to be disconnected.



DANGER



Do not use the device in "regions or aircrafts and vehicles where its use is prohibited" such as in hospitals and airplanes.

This may exert an impact on electronic and medical devices.



Do not use this product while driving or riding a motorbike. This may result in accidents.

Make sure to stop the car in a safe location first before use if the device is going to be used by the driver.



Never touch the antenna during transmission.

This may result in injury, electric shock and equipment failure.



When an alarm goes off with the external antenna connected, cut off the power supply to this radio immediately and disconnect the external antenna from this radio.

If not, this may result in fire, electric shock and equipment failure.

Safety Precautions (make sure to read these)



Do not operate the device when flammable gas is generated.

Doing so may result in fire and explosion.



Do not transmit in crowded places in consideration of people who are fitted with medical devices such as heart pacemakers.

Electromagnetic waves from the device may affect the medical device, resulting in accidents caused by malfunctions.



Do not touch any liquid leaking from the liquid display with your bare hands.

There is a risk of chemical burns occurring when the liquid comes into contact with the skin or gets into the eyes. In this case, seek medical treatment immediately.



WARNING



Do not use voltages other than the specified power supply voltage.

Doing so may result in fire and electric shock.



Do not transmit continuously for long periods of time.

This may cause the temperature of the main body to rise and result in burns and failures due to overheating.



Do not dismantle or modify the device.

This may result in injury, electric shock and equipment failure.



Do not handle the power plug and connector etc. with wet hands. Also do not plug and unplug the power plug with wet hands.

This may result in injury, liquid leak, electric shock and equipment failure.



When smoke or strange odors are emitted from the radio, turn off the power and disconnect the power cord from the socket.

This may result in fire, liquid leak, overheating, damage, ignition and equipment failure. Please contact our company amateur customer support or the retail store where you purchased the device.



Keep the power plug pins and the surrounding areas clean at all times.

This may result in fire, liquid leak, overheating, breakage, ignition etc.



Do not place the device in areas that may get wet easily (e.g. near a humidifier).

This may result in fire, electric shock and equipment failure.



When connecting a DC power cord, pay due care not to mix up the positive and negative polarities.

This may result in fire, electric shock and equipment failure.



Do not use DC power cords other than the one enclosed or specified.

This may result in fire, electric shock and equipment failure.



Do not bend, twist, pull, heat and modify the power cord and connection cables in an unreasonable manner.

This may cut or damage the cables and result in fire, electric shock and equipment failure.



Do not pull the cable when plugging and unplugging the power cord and connection cables.

Please hold the plug or connector when unplugging. If not, this may result in fire, electric shock and equipment failure.

Safety Precautions (make sure to read these)

Do not use the device when the power cord and connection cables are damaged, and when the DC power connector cannot be plugged in tightly.



Please contact our company amateur customer support or the retail store where you purchased the device as this may result in fire, electric shock and equipment failure.

Never cut off the fuse holder of the DC power cord.



This may cause short-circuiting and result in ignition and fire.

Do not use fuses other than those specified.



Doing so may result in fire and equipment failure.

Do not allow metallic objects such as wires and water to get inside the product.



This may result in fire, electric shock and equipment failure.

Refrain from using headphones and earphones at a loud volume.



Continuous exposure to loud volumes may result in hearing impairment.

Disconnect the power cord and connection cables before incorporating items sold separately and replacing the fuse.



This may result in fire, electric shock and equipment failure.

Follow the instructions given when installing items sold separately and replacing the fuse.



This may result in fire, electric shock and equipment failure.

Do not use the device when the alarm goes off.

For safety reasons, please pull the power plug of the DC power equipment connected to the product out of the AC socket.



Never touch the antenna as well. This may result in fire, electric shock and equipment failure due to thunder.



CAUTION

Do not place this device near a heating instrument or in a location exposed to direct sunlight.



This may result in deformation and discoloration.

Do not place this device in a location where there is a lot of dust and humidity.



Doing so may result in fire and equipment failure.

Stay as far away from the antenna as possible during transmission.



Long-term exposure to electromagnetic radiation may have a negative effect on the human body.

Do not wipe the case using thinner and benzene etc.



Please use a soft and dry piece of cloth to wipe away the stains on the case.

For safety reasons, switch off the power and pull out the DC power cord connected to the DC power connector when the device is not going to be used for a long period of time.



If not, this may result in fire and overheating.

Do not throw or subject the device to strong impact forces.



This may result in equipment failure.

Do not put this device near magnetic cards and video tapes.



The data in the cash card and video tape etc. may be erased.

Do not turn on the volume too high when using a headphone or earphone.



This may result in hearing impairment.

Safety Precautions (make sure to read these)



Keep out of the reach of small children.

If not, this may result in injuries to children.



Do not put heavy objects on top of the power cord and connection cables.

This may damage the power cord and connection cables, resulting in fire and electric shock.



Do not transmit near the television and radio.

This may result in electromagnetic interference.



Do not use optional products other than those specified by our company.

If not, this may result in equipment failure.



When using the device in a hybrid car or fuel-saving car, make sure to check with the car manufacturer before using.

The device may not be able to receive transmissions normally due to the influence of noises from the electrical devices (inverters etc.) fitted in the car.



Do not place the device on an unsteady or sloping surface, or in a location where there is a lot of vibration.

The device may fall over or drop, resulting in fire, injury and equipment failure.



Do not stand on top of the product, and do not place heavy objects on top or insert objects inside it.

If not, this may result in equipment failure.



Do not use a microphone other than those specified when connecting a microphone to the device.

If not, this may result in equipment failure.



Do not touch the heat radiating parts.

When used for a long period of time, the temperature of the heat radiating parts will get higher, resulting in burns when touched.



Do not open the case of the product except when replacing the fuse and when installing items sold separately.

This may result in injury, electric shock and equipment failure.

Checking the supplied items

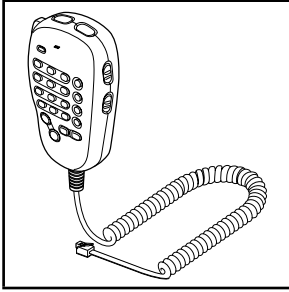

DTMF microphone
MH-48A6JA

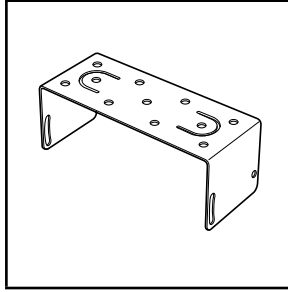

Bracket for main body
MMB-36
Attachment screw set

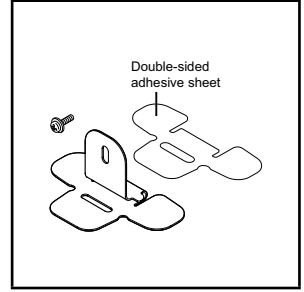

Bracket for the
controller

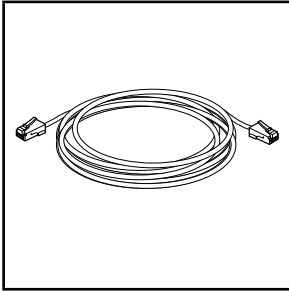

Controller cable
(3 m)

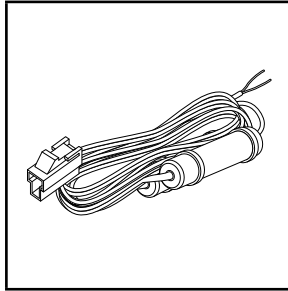

DC power cable
(with fuse attached)

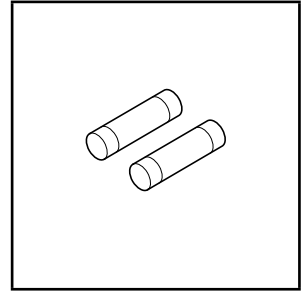

Spare fuse (15 A)

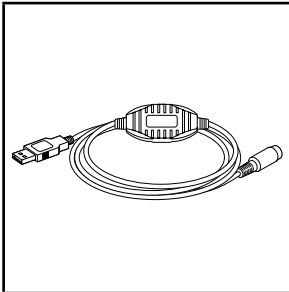

PC connection cable
SCU-20

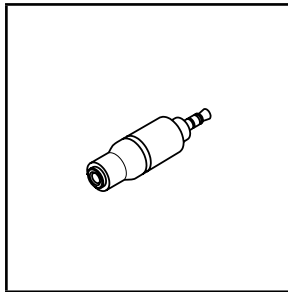

Stereo to monaural plug

Operating Manual (this manual)
Warranty Card

Tip

Various optional parts are also available.
See "Optional components" on page 165 for details.

Name and function of each component

Front panel

Front

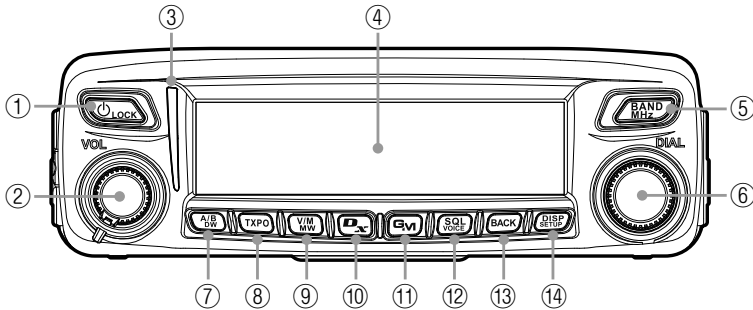

① Power/LOCK key (⏻ Lock)

Pressing the key for over 2 seconds switches the power between ON and OFF. Briefly pressing the key while the transceiver is turned ON engages or releases the key lock.

② VOL knob

Turning the knob clockwise increases the volume, whereas turning it counterclockwise decreases the volume.

③ Mode/Status indicator

Indicates the transmission/reception status with a two-color combination on the upper and lower portions of the mode/status indicator.

Communication status	Upper portion	Lower portion
Receiving analog audio	Green	Green
Transmitting analog audio	Red	Red
Receiving digital audio	Green	Blue
Transmitting digital audio	Red	Blue
Receiving digital data	Green	White
Transmitting digital data	Red	White
Receiving signals with unmatched tone frequency or DCS code	Green	Blink in blue

④ Dot matrix LCD display

⑤ BAND MHz key (BAND MHz)

Switches each band between the operating band and sub-band.









Pressing and holding for over one second allows you to set the frequency in 1 MHz units.

⑥ DIAL knob

- Allows you to set the operating band frequency.

Turning clockwise increases the frequency whereas turning counterclockwise decreases the frequency.

- Allows you to select the desired item for setup, memory registration, group monitoring operation, etc.

- ⑦ A/B DW key ()
Briefly pressing each time switches the operating band between Band A and Band B. Pressing for over one second each time switches the dual watch function between ON and OFF.
- ⑧ TXPO key ()
Briefly pressing each time switches the transmission power (HIGH/MID/LOW). Pressing and holding for over one second each time switches the signaling setting. See “Communicating with specific stations” on page 81.
- ⑨ V/M MW key ()
Briefly pressing each time switches between VFO mode and memory mode. Pressing and holding for over one second displays the memory registration screen.
- ⑩ D/X key ()
Briefly pressing each time switches the operating band communication mode.
Tip For details on the communication mode, see “Selecting communication mode” on page 39. Pressing and holding for over one second activates WIRES-X.
- ⑪ GM key ()
Activates the GM (group monitor) function.
Pressing and holding for over one second displays the logging function screen.
- ⑫ SQL VOICE key ()
Pressing this button briefly and rotating the DIAL sets the squelch level.
Pressing and holding for over one second activates VOICE mode (when the optional FVS-2 is mounted).
- ⑬ BACK key ()
Briefly pressing enables the selected item or value. Then, the display returns to the previously viewed screen.
- ⑭ DISP SETUP key ()
Briefly pressing switches the display information (your location information/received station location information/GPS INFO screen).
Tip For details on the display information, see page 19.
Pressing and holding for over one second displays the Setup menu.

Name and function of each component

Rear

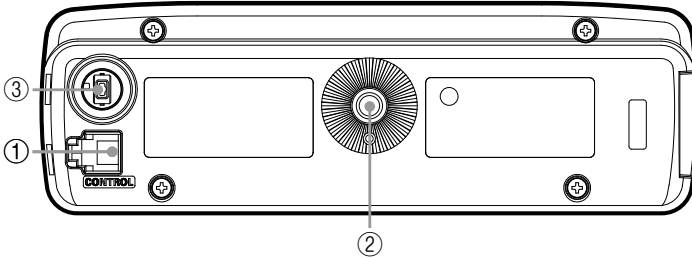

- ① CONTROL jack
Connect the control cable into this jack to connect to the main body.
- ② Screw hole to attach the mounting bracket
- ③ Firmware update switch

Caution Keep the rubber cap on when not in use.

Main body

Front

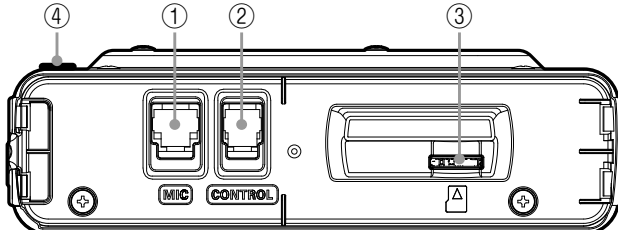

- ① MIC jack
Connect the provided microphone cable.
- ② CONTROL jack
Connect the control cable into this jack to connect to the controller.
- ③ microSD card slot
- ④ Firmware update switch

Caution Keep the rubber cap on when not in use.

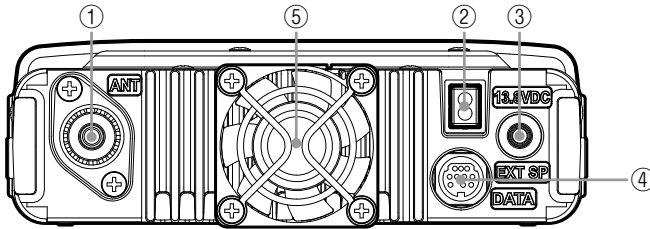
Rear

- ① ANT terminal
Connect the antenna.
- ② 13.8V DC
Connect the provided DC power supply cable (with fuse attached).
- ③ EXT SP jack
Connect the optional external speaker.
- ④ DATA jack
Connect a cable for remote operation or a cable for connecting to devices such as your computer interface unit and the external terminal unit.
- ⑤ Cooling fan

Microphone (MH-48A6JA)

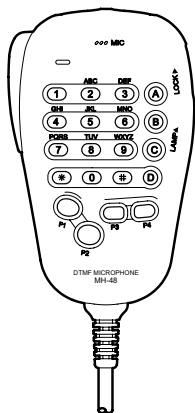
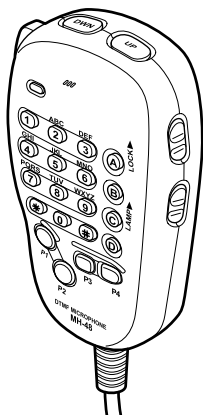

- [UP]** Increases the frequency by one step.
- [DWN]** Decreases the frequency by one step.
- [LOCK]** Locks / unlocks the [UP] and [DWN] keys and [P1] to [P4] keys.
- [LAMP]** Turns the lamp on the body of the microphone on/off.
- [MIC]** Speak into this part during transmission.
- [1] to [0]** Enters the numbers.
- [*]** Switches between VFO and Memory operating mode of the operating band.
- [#]** Activates the GM (Group Monitor) functions.
- [A]** Switches the operating band to the A-band.
- [B]** Switches the operating band to the B-band.
- [C]** Adjusts the squelch level.
- [D]** Switches the display.
- [P1]** Turns off the squelch function.
- [P2]** Recalls the receiver home channel.
- [P3]** Changes the communication mode.
- [P4]** Changes the transmit power.
- [PTT]** Switches the transceiver to transmission mode.

Tip

The desired functions can be assigned to buttons [P1] to [P4]. Select the function from **[8 CONFIG]** → **[10 MIC PROGRAM KEY]** in the Setup menu (page 138).

Screen display

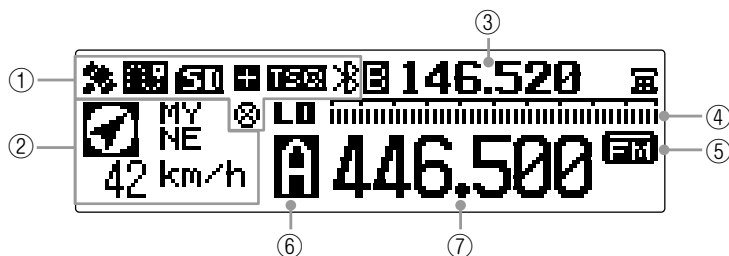

- ① Icon display
Displays the Bluetooth, APRS, microSD memory card and GPS icons when each function is in use.
- ② Station location information display
Displays the received station's location information and your station location information. Briefly pressing the **DISP** key each time switches the displayed data between the received station location, and your station location.
- ③ Sub-band frequency display
While in VFO mode, displays the sub-band name (A or B) and sub-band frequency. While in memory mode, displays the registered frequency or memory tag.
- ④ S-meter display
Displays the S-meter bar graph. Displays the squelch level while adjusting the squelch.
Functions as a power indicator during transmission.
- ⑤ Communication mode display
Displays the current operating mode, such as analog and digital using abbreviations. Auto mode is indicated with a flashing bar appearing above the abbreviation. In Auto mode, the communication mode is automatically set according to the receiving signal.
Tip The AMS functions can be changed in the Setup menu from **[2 TX/RX] → [3 AMS TX MODE]**.
- ⑥ Indicates the operating band name, memory channel, and transmission.
When in VFO mode, the operating band name (A or B) is displayed.
While in memory mode, displays **MA** and the memory channel number for the A-band, and **MB** and the memory channel number for the B-band.
When transmit is keyed, **LO** indicates the "LO" level transmit power, and **MID** indicates the "MID" level transmit power.
- ⑦ Frequency display
Displays the operating band frequency.

Name and function of each component

● GPS INFO screen

While a received station's information is displayed, briefly press the **(DISP SETUP)** key to display the GPS INFO screen.

May also display the compass and the signal level of each acquired satellite. □ indicates an un-acquired satellite and ■ indicates an acquired satellite.

Tip From [1 DISPLAY] → [4 GPS INFORMATION], you can select "LOCATION" (location display) or "FREQUENCY" (frequency display).

[Location display]



[Frequency display]

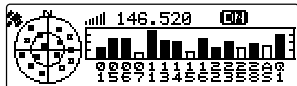

Input characters

You can input letters and characters to enter your call sign and memory channel tags by following the procedure below.

Switching the character type

Press **(TXPO)** (**A/E** appears on the upper display). Pressing each time changes the character type in the following order.

Uppercase letters → symbols → lowercase letters → numbers

Deleting the input characters

Press **(V/M MW)** (**CLR** appears on the upper display).

Deletes all characters to the right side of the cursor including the character on which the cursor is currently positioning.

Moving the cursor to the left

Press **(D<)** (**←** appears on the upper display).

Moving the cursor to the right

Press **(D>)** (**→** appears on the upper display).

Deleting the most recently input character

Press **(SQL VOICE)** (**←X** appears on the upper display).

Completing input

Press **(DISP SETUP)**. To cancel inputting, press **(BACK)**.

Installing the transceiver

Precautions on installation

Note the following when installing the transceiver.

- Do not install the transceiver in a place where it would be exposed to direct sunlight, high temperatures, excessive humidity, dusty conditions, or extreme vibrations.
- Install the transceiver in a well-ventilated position, so that heat dissipation is not hindered, because the heat sinks will become hot when the transceiver is run for an extended period of time.
- Do not place any objects on the transceiver.
- Do not attempt to lift the front panel by holding onto just the knob or control cable.
- This transceiver requires a 13.8 V DC power supply.
When using this transceiver in a mobile unit, ensure that the car battery is a 12 V type. Never connect this transceiver to a 24 V battery of a large vehicle.
- Never connect the transceiver to a 100 V AC power source.
- Heed caution as hum and noise may be introduced, depending on the installation conditions of the external power source.
- Install the transceiver as far away as possible from TVs and radios. Failing to do so may result in noise interference such as broadcast interference (BCI) or television interference (TVI) from radios and TVs respectively.
Never attempt to install this transceiver near indoor antenna elements.

Installation location when used in a mobile unit

● Front panel

To efficiently receive the GPS satellites, it is recommended that the transceiver should be installed on the dashboard or front side of the center console. See “Installing the front panel” on page 26

Tip The GPS reception antenna is built into the front panel.

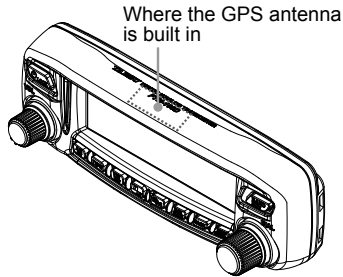

● Main body

It is recommended that the main body be installed below the car dashboard or to either side of the center console. See “Installing the main body” on page 25

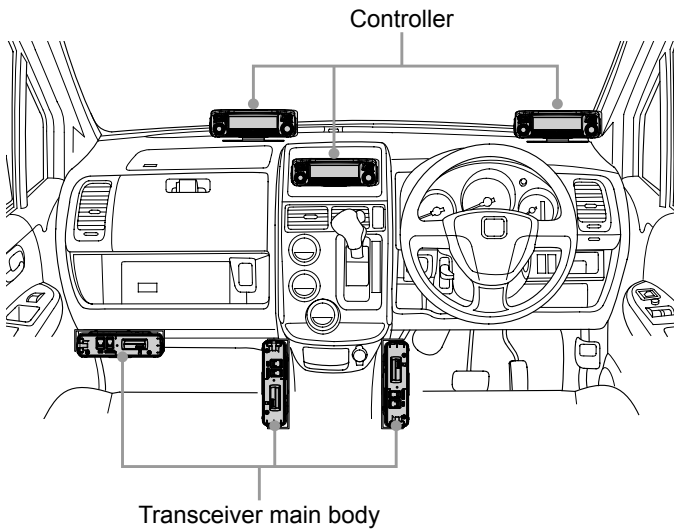

About the antenna

The antenna is an extremely important part for both transmitting and receiving. The antenna type and its inherent characteristics determine whether the performance of the transceiver can be fully realized. As such, please note the following:

- Use an antenna that is suitable for the installation conditions and application objective.
- Use an antenna that is suitable for the operating frequency band.
- Use an antenna and a coaxial cable with a characteristic feed point impedance of 50Ω .
- Adjust the VSWR (Voltage Standing Wave Ratio) until it is 1.5 or less for an antenna with an adjusted impedance of 50Ω .
- Keep the coaxial cable routing length as short as possible.

Installing the antenna

● Antenna installation in a mobile unit

Install the antenna base to the rear of the car (rear bumper, trunk, rear gate, etc.) and then attach the antenna to the base.

Cautions

- Verify that the antenna base is securely grounded to the car body.
- When using a coaxial cable included with a commercially-available on-vehicle antenna, lay the cable in a way to keep it as short as possible.
- Do not allow rain water or moisture to penetrate the entrance of the cable or connectors when routing the coaxial cable inside the vehicle.

Bumper type

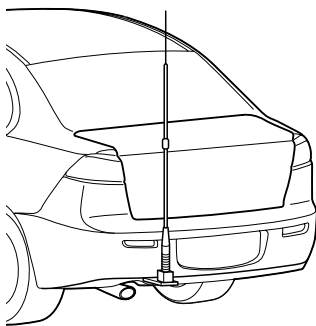

Trunk type

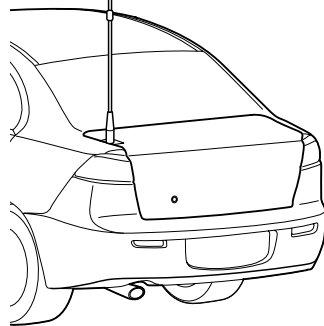

Installing the transceiver

● Antenna installation when using a fixed station

For use in an outdoor setting, there are omni-directional antennas and a variety of directional antennas.

- Omni-directional antennas such as the GP (Ground Plane) antenna are suitable for communications with a local station or mobile stations in all directions.
- Directional antennas such as the Yagi antenna are suitable for communications with a specific station or a remote station in a specific direction.

Cautions

- Create a loop (slack) in the coaxial cable directly underneath the antenna and fasten the coaxial cable so that the weight of the cable does not pull on the antenna.
- When installing the antenna, take into consideration the securing supports and how the guy wires are positioned, so that the antenna does not fall over or get blown away by strong wind gusts.

GP antenna

<balcony-mounted example>

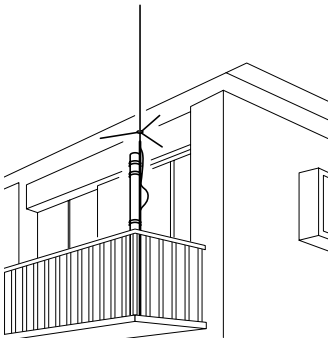

Yagi antenna

<roof-mounted example>

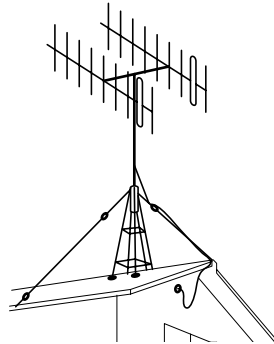

Installing the main body

Install the main body using the supplied MMB-36 bracket.

- 1 Select the installation location.

Caution Select a location where the transceiver can be securely attached.

Tip See “Installation location when used in a mobile unit” on page 22.

- 2 Drill four 6 mm diameter holes in the location where the bracket is to be mounted, matching the positions of the bolting holes of the bracket.

- 3 Attach the bracket.

Attach the bracket using the supplied bolts, nuts and washers.

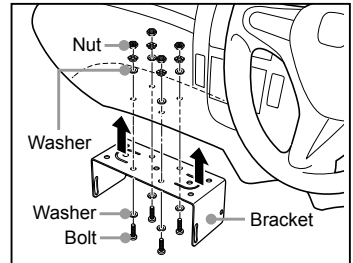

- 4 Attach the main body to the bracket.

Fasten the main body to the bracket, using the supplied flange bolts, as shown in the illustration.

Tip The mounting angle can be changed depending on the securing position of the flange bolts.

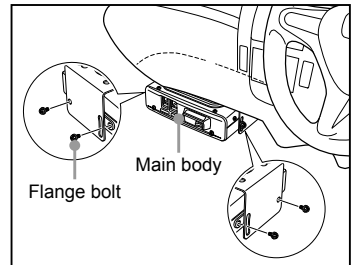

Installing the front panel

Install the front panel using the supplied bracket.

Caution

The bracket can be formed by hand to match the location where the front panel is installed. Be careful not to cause an injury when bending the bracket.

- 1 Select the installation location.

Caution Select a stable, flat location with as few dents and protrusions as possible.

Tip See "Installation location when used in a mobile unit" on page 22.

- 2 Attach the bracket to the front panel.

Attach the bracket to the front panel using the supplied screws as shown in the illustration.

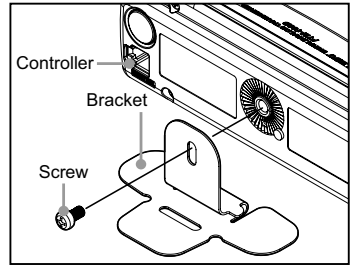

- 3 Adhere double-sided adhesive sheet to the bracket.

Peel off the protection tape from one side of the supplied double-sided adhesive sheet, and paste it onto the bottom side of the bracket.

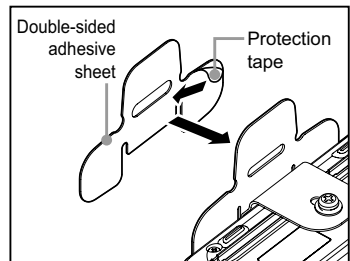

- 4 Install the bracket where you want to place the front panel.

After the adhesive sheet is adhered to the bottom side of the bracket, Peel off the other side of the protection tape, and then stick the bracket to the installation location.

Caution Remove all dirt and dust from the installation location before affixing the bracket.

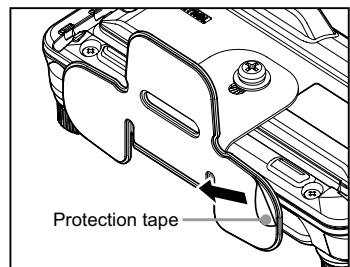

Connecting the transceiver

Connecting the front panel to the main body

Caution

Make sure to turn the transceiver OFF before connecting.

- 1 Connect the supplied control cable to the transceiver main body.
Push the control cable plug into the CONTROL jack on the front panel of the transceiver main body, until it clicks.
- 2 Connect the other side of the front panel to the control unit.
Push the other control cable plug into the CONTROL jack on the transceiver control front panel, until it clicks.

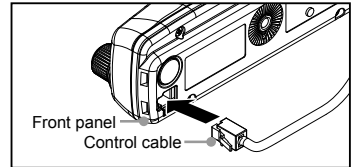
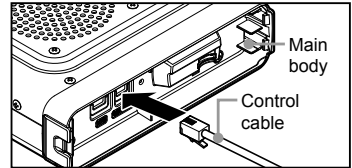

Connecting the microphone

- 1 Connect the supplied microphone to the main body.
Plug the microphone connector into the MIC jack on the front panel until it clicks.

- Tips**
- When disconnecting the microphone, pull the cable while pressing the connector latch.
 - To use an 8-pin connector microphone, use the optional microphone extension kit "MEK-2". An extension cable (Approx. 3 m) is supplied with MEK-2 allowing you to operate further away from the main body.

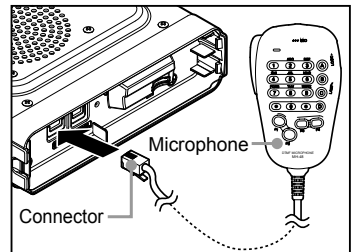

Connecting the antenna

- 1 Connect the coaxial cable to the main body.
Plug the coaxial cable jack into the ANT terminal on the rear panel of the main body, then rotate and tighten it.

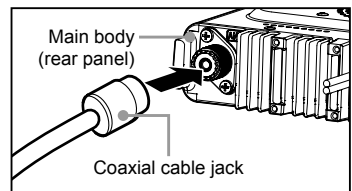

Connecting the power supply

Connecting the car battery

When using the transceiver as a mobile unit, connect the DC power supply cable to the car battery.

Cautions

- Use the transceiver in a car with a negative ground system where the minus (-) pole of the battery is connected to the car body.
- Check the car battery specification is 12 V. Do not connect the transceiver to the 24 V battery of a large vehicle.
- Do not use the cigarette lighter socket inside the car as a power source.

(1) Cabling from inside the car to the engine compartment

Rout the DC power supply cable to the engine compartment passing it through a grommet.

- 1 Feed a stiff wire from the engine compartment through the grommet into the car.
- 2 Twist the “bare wire” end of the supplied DC power supply cable around the end of the “feed” wire.
- 3 Bend the ends of the wires and wind insulation tape around them.
- 4 Pull the “feed” wire back into the engine compartment.
The DC power supply cable is pulled into the engine compartment.
- 5 Peel off the tape and remove the DC power supply cable from the wire.

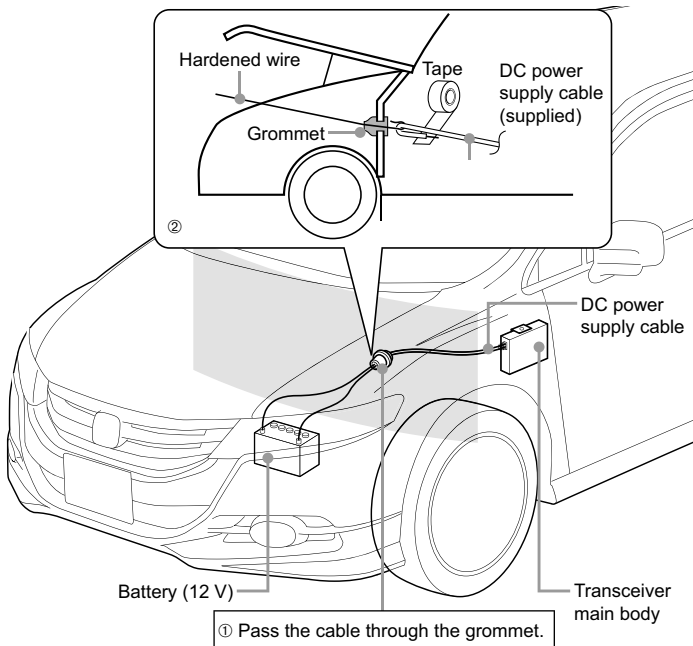

(2) Connecting the power supply cable

Cautions

- Do not use a DC power supply cable other than the one that is supplied or specified.
- Do not place anything on the DC power supply cable or step on it.
- Do not use the DC power supply cable with the fuse holder cut off.
- Do not reverse the polarity (positive and negative) when connecting the battery.

- 1 Disconnect the minus (-) terminal from the battery.
This prevents short-circuit while working on the cables.
- 2 Attach crimped terminals to the bare ends of the DC power supply cable.
Obtain commercially available terminals and crimp or solder them to both the red (+) and black (-) wire ends of the DC power supply cable.

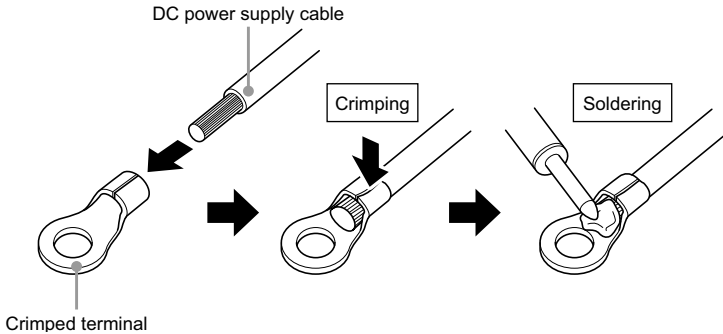

- 3 Connect the red wire (+) of the DC power supply cable to the positive (+) terminal of the battery.

Caution Securely connect the DC power supply cable in order not to get disconnected.

- 4 Reconnect the negative (-) terminal of the battery that was disconnected.
- 5 Connect the black wire (-) of the DC power supply cable to the negative (-) terminal of the battery.

Caution Securely connect the DC power supply cable in order not to get disconnected.

- 6 Connect the DC power supply cable to the main body.

Plug into the connector of the main body power cable until it clicks.

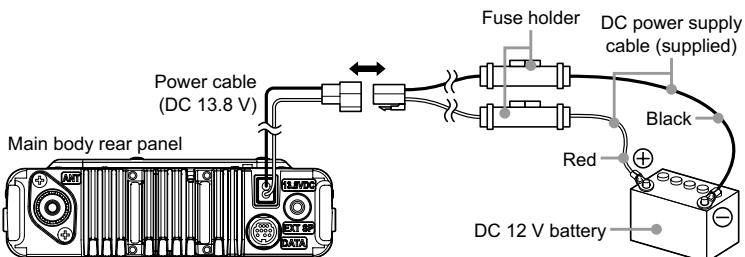

Connecting the power supply

Connecting the external power supply equipment

When using the transceiver as a fixed station, use an external power source.

Cautions

- Use an external power source capable of supplying DC 13.8 V, a current capacity of 20 A or more.
- Make sure to switch OFF the power of the external power source before connecting.

- 1 Connect the DC power supply cable to the external power supply equipment.
Connect the red wire (+) of the supplied DC power supply cable to the positive (+) terminal of the external power source, and the black wire (-) to the negative (-) terminal of the external power source.
- 2 Connect the DC power supply cable to the main body.
Plug into the connector of the main body power cable until it clicks.

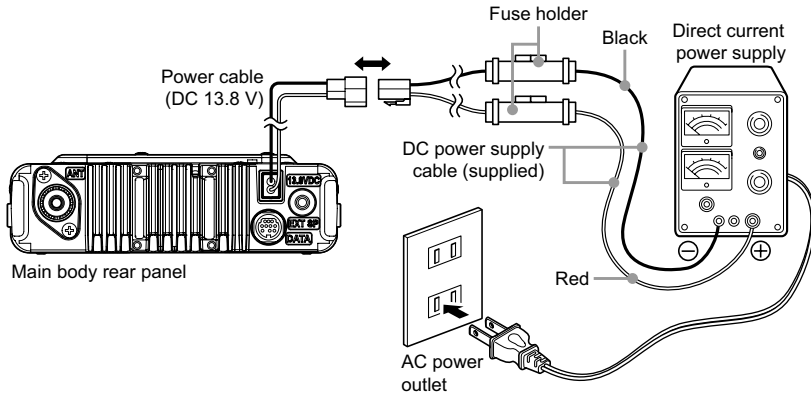

Preparing a microSD memory card

The following operations can be carried out by using a microSD memory card with the transceiver.

- Backing up the information and settings of the transceiver
- Saving the GPS log data
- Saving data downloaded using the GM function and WIRELESS-X function
- Exchanging the saved data among multiple transceivers

microSD cards supported by the transceiver

This transceiver supports 2 GB microSD memory card and 4 GB, 8 GB, 16 GB, 32 GB microSDHC memory card

Cautions

- Any microSD or microSDHC memory card is supplied with the transceiver.
- Not all microSD and microSDHC memory cards sold commercially are guaranteed to work with this product

Notes on using microSD memory cards

- Do not bend the microSD memory card or place heavy objects on top of it.
- Do not touch the terminal face of the microSD memory card with your bare hands.
- microSD memory cards that are initialized on other devices may not record normally on the transceiver. Reinitialize the microSD memory card on the transceiver when using such a card. (For details, see “Initializing microSD memory cards” on page 33.)
- Do not pull the microSD memory card out or turn off the transceiver while reading or writing data from/to the card.
- Do not insert anything other than a microSD memory card into the microSD card slot of the transceiver.
- Do not pull out or insert the microSD memory card with unreasonable force.
- When a single microSD memory card is used for a long period of time, writing and deletion of data may become disabled. Use a new microSD memory card when data can no longer be written or erased.
- Note that Yaesu shall not be liable for any damages suffered as a result of data loss or corruption in use of the microSD memory card.

Preparing a microSD memory card

Inserting a microSD memory card

- 1 Press and hold  for over 2 seconds to turn the transceiver OFF.

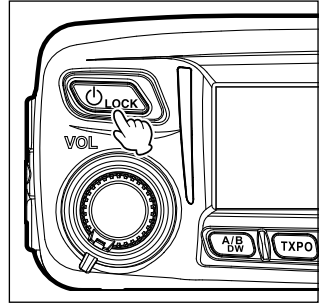

- 2 Insert the microSD memory card into the microSD card slot.

With the terminal side up, insert the card into the slot until it clicks.

- Cautions**
- Insert the microSD memory card, as shown, with the correct orientation.
 - Do not touch the terminal of the microSD memory card with your hands.

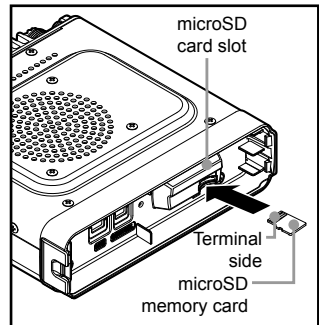

After turning the transceiver ON, the  icon appears on the top right side of the screen.

Tip It may take a while for the icon to appear depending on the card capacity.

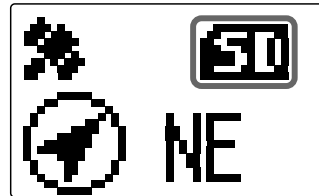

Removing the microSD memory card

- 1 Press and hold  for over 2 seconds to turn the transceiver OFF.
- 2 Push in on the microSD memory card.
A click sound is heard and the microSD memory card is pushed outward.
- 3 Remove the microSD memory card from the microSD card slot.

Initializing microSD memory cards

When using a new microSD memory card for the first time with the FTM-100DR, initialize it by following the procedure below.

Caution

Initializing deletes all the data recorded on the microSD memory card. Check the contents of the microSD memory card before initialization.

- 1 Press and hold **DISP SETUP** for over one second.
The Setup menu appears.

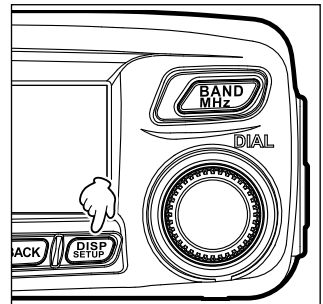

- 2 Rotate the DIAL to select **[11 SD]**, then press **DISP SETUP**.
The menu list appears.

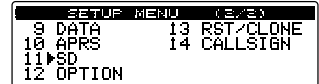

- 3 Rotate the DIAL to select **[2 FORMAT]**, then press **DISP SETUP**.
The format confirmation screen appears.



- 4 Rotate the DIAL to select **[OK?]**, then press **DISP SETUP**.
Initializes the microSD memory card.



Tip To cancel initialization, rotate the DIAL to select **[Cancel]**, then press **DISP SETUP**.

After completing initialization, "Completed" appears, and then the display returns to the menu list screen.

Receiving

Turning the power on

- 1 Press and hold  for over 2 seconds.

The power switches on, and the display appears on the screen.

<When using the same call sign for digital and APRS>



<When using separate call signs for digital and APRS>

The call sign for digital appears on the left and the call sign for APRS appears on the right.

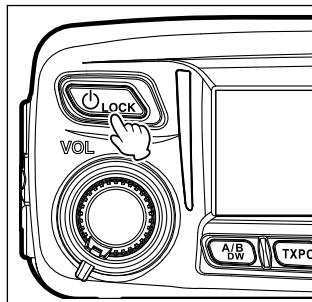

- Tips**
- When turning the transceiver on for the first time, or after resetting the transceiver, a screen requesting input of a call sign appears.
 - When turning the transceiver on thereafter, the previously registered call sign will be displayed.

Switching the power off

- 1 Press and hold  for over 2 seconds.

The screen display disappears, and the power switches off.

Inputting the call sign

A screen requesting input of a call sign appears when turning the transceiver on for the first time, or after resetting the transceiver.

The call sign is used to identify the transmitting station when communicating in digital mode.

- 1 Rotate the DIAL to select characters, then press



- Tips**
- Up to 10 characters (alphanumeric characters including hyphen) can be entered.
 - See "Input characters" on page 20 on how to operate the character input screen.

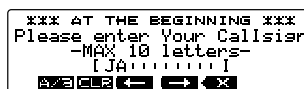
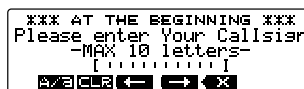

- 2 Press **DISP SETUP**.
The display changes.

The entered call sign appears at the bottom of the screen, and the screen switches to the frequency display screen.

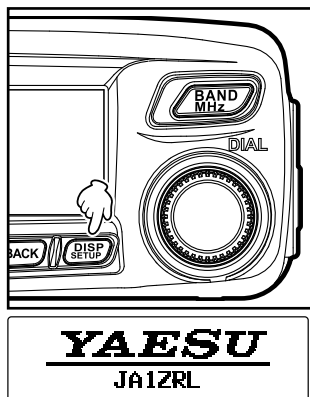

Toggling the operating band

Normally, 2 operating bands appear on the top half and bottom half of the screen. The frequency and modulation mode may be changed only for the band on the top half of the screen, which is called “operating band”. The other band, displayed on the bottom half of the screen, is not in operation, and is called the “sub-band”.

- 1 Press **A/B BW**.
Each press toggles the operating band between A-band and B-band.

Caution The operating band signals and sub-band signals cannot be received simultaneously.

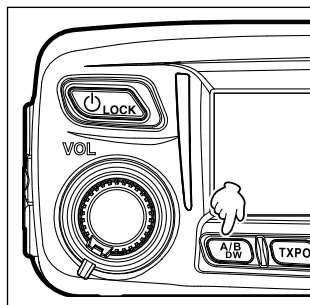

Adjusting the volume level

- 1 Rotate **VOL**.
Clockwise rotation increases the volume, whereas counterclockwise rotation decreases the volume.

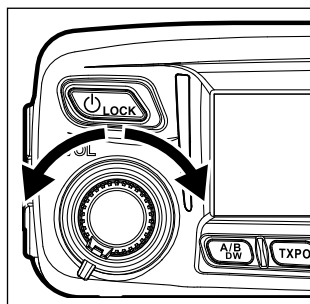

Adjusting the squelch level

Annoying noises can be eliminated when there is no signal present. The A-band and B-band squelch levels can be individually adjusted. Increasing the squelch level will be more effective in reducing noise; however setting the squelch level too high may block weak signals. Adjust the squelch level as required.

- 1 Press **SQL VOICE**.

The current squelch level is shown on the sub-band display and on the SQL meter.

Tip In digital mode, noise does not occur even if the squelch level is set to 0.

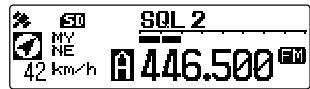
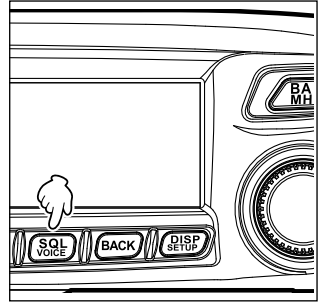

- 2 Rotate the DIAL to adjust the squelch level.

The squelch level value is shown on the sub-band display, and the level is displayed on the SQL meter.

Tip The display returns to the normal operating screen three seconds after the squelch is adjusted, or if no adjustment is made.

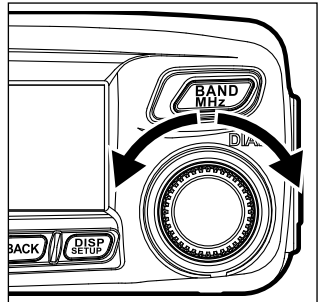

Tuning in to the frequency

● Using the DIAL

- 1 Rotate the DIAL.
Clockwise rotation tunes the frequency upwards, whereas counterclockwise rotation tunes the frequency downwards.

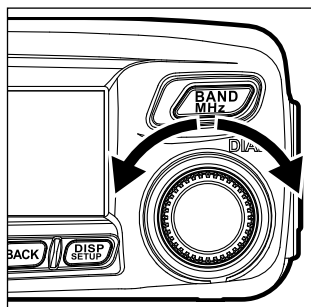

● Using the microphone

Press [UP] and [DWN] briefly

Pressing [UP] briefly, tunes the frequency upwards. Whereas pressing [DWN] briefly tunes the frequency in the downward direction.

Using the number keys

Use the ① to ⑨ number keys to directly input the frequency.

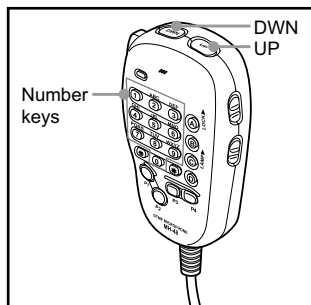

Changing the frequency steps

The DIAL and microphone [UP]/[DWN] keys frequency tuning step can be changed.

- 1 Press **DISP SETUP** for over one second.
The Setup menu appears.

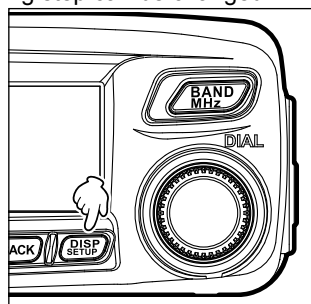

Receiving

- 2 Rotate the DIAL to select [8 CONFIG], then press



The menu list appears.

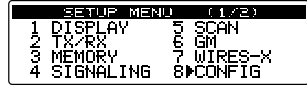

- 3 Rotate the DIAL to select [7 FM AM STEP], then press

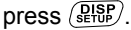

- 4 Rotate the DIAL to select the desired frequency step.

The frequency steps change in the following order:

“AUTO” → “5.00 KHz” → “6.25 KHz” → “8.33 KHz”
 → “10.00 KHz” → “12.50 KHz” → “15.00 KHz” →
 “20.00 KHz” → “25.00 KHz” → “50.00 KHz” →
 “100.00 KHz”



Tips • The default setting: AUTO

- The 8.33 kHz frequency step can be selected only on the Air band.
- The 5 kHz, 6.25 kHz or 15 kHz frequency step cannot be selected on 480 MHz or higher frequency.

- 5 Press and hold for over one second.

The selected frequency step is set, and the display returns to the previous operating display.

Tip To return to the previous operating display press 3 times.

Switching the operation mode

The operating mode can be switched between VFO mode and MEMORY mode. In VFO mode, the operating frequency may be freely adjusted; in MEMORY mode, the memory channels are recalled and displayed on the screen for operation.

- 1 Select the desired operating band.

- 2 Press .

The display switches to MEMORY mode.

or and the memory channel number appear on the operating band name display.

Tips • appears on the A-band.

- appears on the B-band.

When a name (tag) has been assigned to the memory channel, the tag appears on the frequency display or the sub-band display.

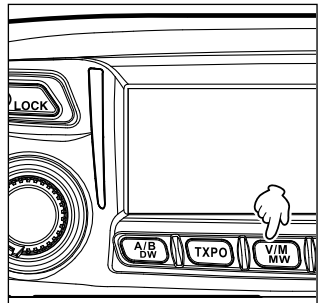

3 Press .

The display switches to VFO mode and returns to the previous receive frequency.

Selecting communication mode

The FTM-100DR transceiver is equipped with the AMS (Automatic Mode Select) function which automatically selects from 4 modes of transmission corresponding to the signal being received.



The transmit mode is selected according to the received signal so that C4FM digital signals, and analog signals are received and transmitted automatically.

Press  to display "oo" on the screen.

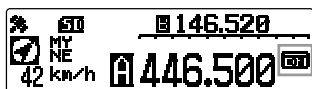
*The display differs depending on the received signal.



Display example when in AMS mode

To operate in fixed communication mode, press  to switch the communication mode. Each time  is pressed, the communication mode changes in the following order:

" (AMS)" → "DN (V/D mode)" → "VW/DW (FR mode)" → "FM (analog)"

Operation mode	Icon	Description of modes
AMS (Automatic Mode Select)		Transmission mode is automatically selected from 4 types according to the signal received. (“oo” icon differs depending on the received signal.) The AMS function operation can be changed from the Setup menu setting. See “Setting the transmission mode when using the AMS function (3 AMS TX MODE)” on page 125.
V/D Mode (Voice/Data simultaneous transmission mode)	DN	Calls are less prone to interruptions due to detection and correction of voice signals during digital voice signal transmission. This is the standard mode for C4FM Digital.
Voice FR Mode (Voice Full Rate Mode)	VW	Digital voice data transmission using the entire 12.5 kHz band. Enables high-quality voice communication.
Data FR Mode (High Speed Data Communication Mode)	DW	High speed data communication using the entire 12.5 kHz band. The transceiver automatically switches to this mode during image transmission.
Analog FM Mode	FM	Analog communication using FM mode. Effective when the signal is weak and audio is susceptible to interruption in digital mode.

Cautions

- In V/D mode (“DN” on the screen), location information is included in the transmitted signal during voice communication, however, location information is not included with the Voice in the FR mode (“VW” on the LCD).

Switching the modulation mode

In analog mode, the modulation mode can be selected from “AUTO”, “MANUAL (FM)” and “MANUAL (AM)”.

When shipped from the factory, the mode is set to “AUTO” where the most optimal modulation mode is automatically selected according to the frequency.

- 1 Select the desired operating band.
- 2 Press and hold **DISP SETUP** for over one second.
The Setup menu appears.

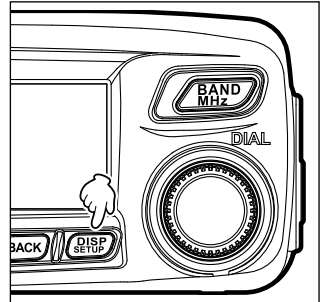

- 3 Rotate the DIAL to select **[2 TX/RX]**, then press **DISP SETUP**.

The menu list appears.

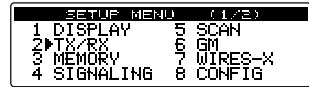

- 4 Rotate the DIAL to select **[1 ANALOG MODE SELECT]**, then press **DISP SETUP**.

The modulation mode setting value appears.

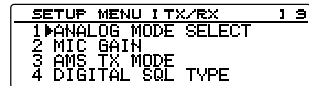

- 5 Rotate the DIAL to select the desired modulation mode.

“1 AUTO”: Automatically switches the modulation mode to match the frequency band.

“2 MANUAL(FM)”: Switches to FM mode.

“3 MANUAL(AM)”: Switches to AM mode.

Tip The default setting: AUTO

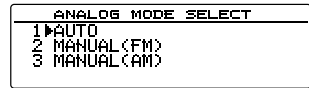

- 6 Press and hold **DISP SETUP** for over one second.

Sets the selected modulation mode and returns the display to the previously viewed screen.

Tip You can also return to the previous screen by pressing **BACK** 3 times.

Transmitting

- 1 Press and hold **[PTT]** on the microphone.
In analog mode, both the upper and lower portions of the mode/status indicator light red.
In digital mode, the upper portion of the mode/status indicator lights red and the lower portion of the mode/status indicator lights blue.

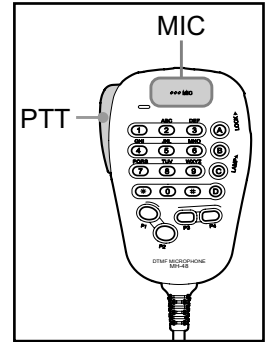
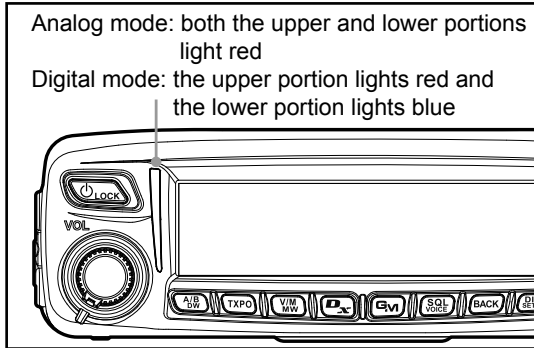

- 2 Speak into **[MIC]** on the microphone.
Tip Keep the microphone about 5 cm away from your mouth.
- 3 Release **[PTT]**.
The transmit mode/status indicator turns off and the transceiver returns to the receive mode.

Tips

- Do not continue transmitting for a prolonged period. The transceiver may overheat, resulting in malfunction or burn.
- Use the optional cooling fan SMB-201 to effectively cool down the transceiver that has heated up due to continuous transmission.
- "ERROR TX FREQ" appears if you attempt to transmit an unavailable frequency.

Adjusting the transmit power

When communicating with a nearby station, the transmit power level may be lowered to reduce the battery power consumption.

- 1 Press **TXPO**.

Each time **TXPO** is pressed, the transmit power level changes in the following order:

“HIGH” → “LOW” → “MID”

Model	HIGH	MID	LOW
FTM-100DR	50 W	20 W	5 W

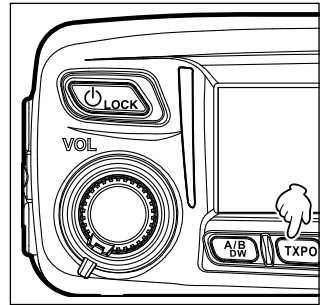

Adjusting the microphone sensitivity

The sensitivity (gain) of the microphone can be adjusted.

- 1 Press and hold **DISP SETUP** for over one second.

The Setup menu appears.

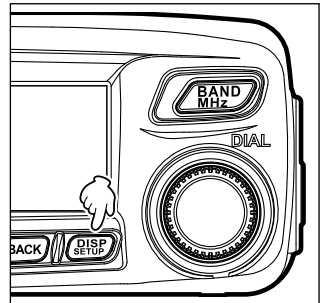

- 2 Rotate the DIAL to select **[2 TX/RX]**, then press

DISP SETUP.

The menu list appears.

- 3 Rotate the DIAL to select **[2 MIC GAIN]**, then press

DISP SETUP.

The microphone gain setting value appears.

- 4 Rotate the DIAL to select the desired microphone gain setting.

“1 MIN” → “2 LOW” → “3 NORMAL” → “4 HIGH”

Tip The default setting: 3 NORMAL

- 5 Press and hold **DISP SETUP** for over one second.

The microphone sensitivity is set and the display returns to the previous operating screen.

Tip You can also return to the previous operating screen by pressing **BACK** 3 times.

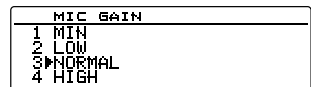
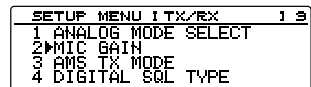
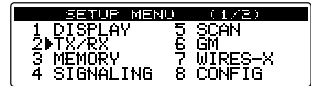

Communicating in FM mode

- 1 Select the desired operating band.
- 2 Set the modulation mode to “MANUAL (FM)”.
- 3 Rotate the DIAL to tune to the desired frequency.
- 4 While pressing and holding **[PTT]**, speak into the microphone.

Tip

To use the half deviation, select “1 ON” from **[2 TX/RX]** → **[9 HALF DEVIATION]** in the Setup menu.

Communicating using the repeater

The FTM-100DR includes the ARS (Automatic Repeater Shift) function which permits communication through repeaters automatically, by simply setting the receiver to the repeater frequency.

- 1 Tune to the repeater frequency.

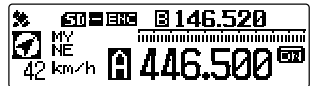

- 2 Press the **[PTT]** to transmit.

During transmission, radio waves having an 100.0 Hz tone signal are emitted on the frequency lower than reception frequency by 5 MHz.

Tip

From the Setup menu, you can change the repeater setting.

[8 CONFIG] → **[4 AUTO REPEATER SHIFT]**: Deactivates the ARS function.

[8 CONFIG] → **[5 REPEATER SHIFT]**: Allows setting the repeater shift direction.

[8 CONFIG] → **[6 REPEATER SHIFT FREQ]**: Allows changing the repeater shift frequency offset.

Changing the 100.0 Hz CTCSS tone squelch

To communicate with a repeater that uses a tone signal other than 100.0 Hz, change the CTCSS tone frequency using the setup menu.

1 Tune the transceiver receiver frequency to the repeater frequency.

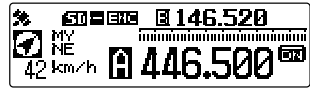

2 Press **DISP SETUP** for more than one second. Setup menu appears.

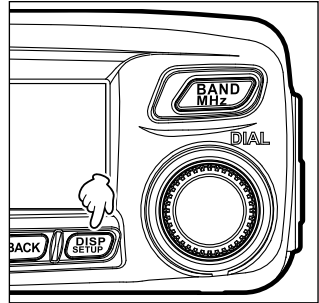

3 Turn the DIAL to select **[4 SIGNALING]**, and then press **DISP SETUP** to display the menu list.

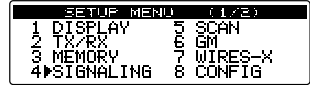

4 Turn the DIAL to select **[1 TONE SQL FREQ]** and then press **DISP SETUP**, the CTCSS tone frequency will be displayed.

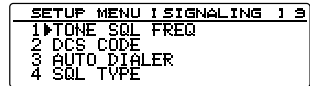

5 Turn the DIAL to change and select the different tone frequency.



6 Press **DISP SETUP** for more than one second to set the new tone and return to the original operating screen.

Tip You can also return to the previous operating screen by pressing **BACK** 3 times.

7 Press the **[PTT]** to transmit.

The transmit frequency is automatically offset to the repeater input frequency, and the squelch tone signal is set.

Tip

The squelch tone and transmit offset frequency will be recorded whenever the displayed frequency is registered to a memory channel. (Refer to "Registering to the memory channel" on page 51).

Other settings

Changing the beep volume

The volume of the key operation “beep sound” can be adjusted.

- 1 Press and hold **DISP SETUP** for over one second.
The Setup menu appears.

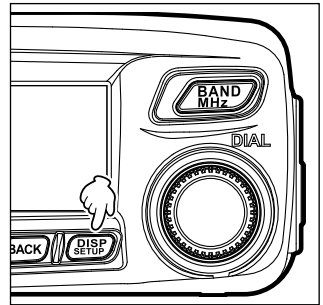

- 2 Rotate the DIAL to select **[8 CONFIG]**, then press **DISP SETUP**.
The menu list appears.

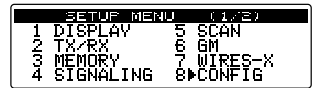

- 3 Rotate the DIAL to select **[8 BEEP]**, then press **DISP SETUP**.
The volume setting value appears.

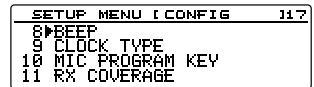

- 4 Rotate the DIAL to select the desired volume level.
“1 OFF” → “2 LOW” → “3 HIGH”

Tip The default setting: 2 LOW



- 5 Press and hold **DISP SETUP** for over one second.



The selected beep volume level is set and the display returns to the previous operating screen.

Tip You can also return to the previous screen by pressing **BACK** 3 times.

Locking the DIAL and keys

To prevent accidental frequency change during operation, the DIAL and keys can be locked.

Tip VOL is not locked.

- 1 Press  briefly.
“LOCK” will be displayed on the screen and the DIAL and keys will be inoperative.
Press  briefly again to unlock the DIAL and keys. “UNLOCK” will be displayed on the screen.

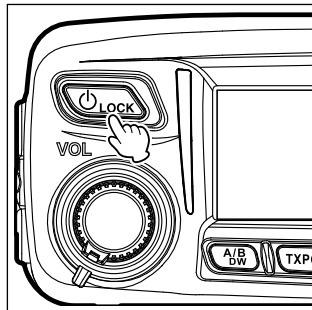



Adjusting the date and time

The FTM-100DR transceiver has a built-in clock. Set the time and date before using the radio. Also the clock is automatically set when signals are received from the GPS.

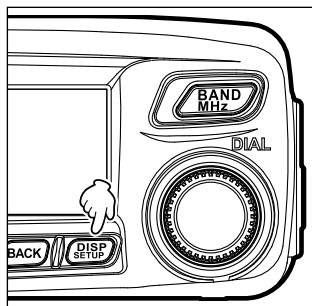
- 1 Press and hold  for over one second.
The Setup menu appears.



- 2 Rotate the DIAL to select **[8 CONFIG]**, then press .
The menu list appears.
- 3 Rotate the DIAL to select **[1 DATE & TIME ADJUST]**, then press .

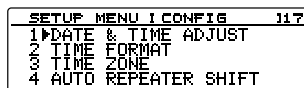
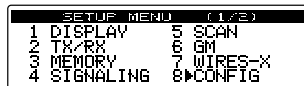

The current date and time settings appear.

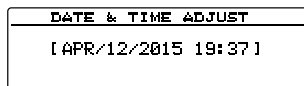

- 4 Press **DISP** **SETUP**.

The “Month” display blinks.

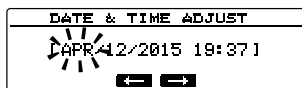

- 5 Rotate the DIAL to select the month

- 6 Press **Gv** (**→** appears on the upper side).

The “Day” display blinks.

Tip Press **Dx** to go back (**←** appears on the upper side).

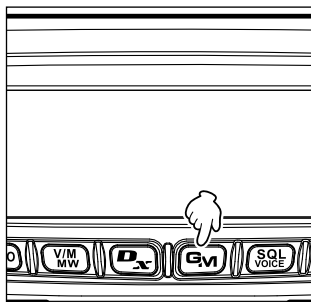

- 7 Rotate the DIAL to select the day.

- 8 Press **Gv** (**→** appears on the upper side).

The “Year” display blinks.

Tip Press **Dx** to go back (**←** appears on the upper side).

- 9 Rotate the DIAL to select the year.

- 10 Press (**→** appears on the upper side).

The “Hour” display blinks.

Tip Press **Dx** to go back (**←** appears on the upper side).

- 11 Rotate the DIAL to select the hour.

- 12 Press (**→** appears on the upper side).

The “Minute” display blinks.

Tip Press **Dx** to go back (**←** appears on the upper side).

- 13 Rotate the DIAL to select the minute.

- 14 Press **DISP** **SETUP**.

The date and time are set, and the screen returns to the setting screen.

- 15 Press and hold **DISP** **SETUP** for over one second.

The display is returned to the previously viewed screen.

Tip You can also return to the previous operating screen by pressing **BACK** 3 times.

Tips

- At normal temperature, the time accuracy is ± 30 seconds per month. It may vary depending on the temperature and environment conditions.
- The time is automatically set when signals are received from the GPS.
- When you use the transceiver for the first time, the setting of the clock may be inaccurate. In such a case, readjust the time.
- The calendar can display dates from January 1, 2000 A.D. up to December 31, 2099 A.D.

Adjusting the display brightness

The brightness and contrast of the display can be adjusted.

- 1 Press and hold **DISP SETUP** for over one second.
The Setup menu appears.

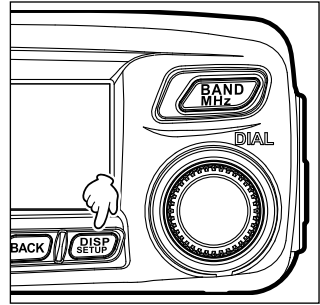

- 2 Rotate the DIAL to select **[1 DISPLAY]**, then press **DISP SETUP**.
The menu list appears.

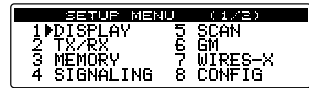

- 3 Rotate the DIAL to select **[2 LCD BRIGHTNESS]**, then press **DISP SETUP**.



The brightness level adjustment screen appears.

- 4 Rotate the DIAL to select the desired brightness level.



The brightness level can be selected from the following 7 levels.

“MIN”, “2”, “3”, “4”, “5”, “6” and “MAX”

Tip The default setting: MAX

- 5 Press **BACK**.

Tip To complete the setting, press and hold **DISP SETUP** for over one second. To adjust the contrast level thereafter, proceed to step 6.

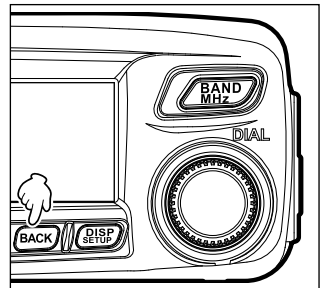

- 6 Rotate the DIAL to select **[3 LCD CONTRAST]**, then press **DISP SETUP**.



The screen where the contrast level may be selected appears.

- 7 Rotate the DIAL to select the desired contrast level.
The contrast may be selected from the following 7 levels.



“-3”, “-2”, “-1”, “0”, “+1”, “+2” and “+3”

Tip The default setting: 0

- 8 Press and hold **DISP SETUP** for over one second.

The selected contrast level is set and the display returns to the previous operating screen.

Tip You can also return to the previous screen by pressing **BACK** 3 times.

Restoring defaults (All Reset)

All transceiver settings and memory content may be restored to the defaults.

- 1 Press and hold **DISP SETUP** for over one second.

The Setup menu appears.

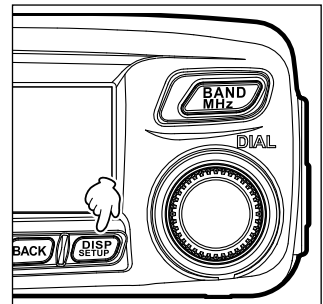

- 2 Rotate the DIAL to select **[13 RST/CLONE]**, then press **DISP SETUP**.

The menu list appears.



- 3 Rotate the DIAL to select **[1 FACTORY RESET]**, then press **DISP SETUP**.

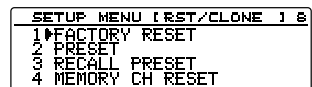

- 4 Rotate the DIAL to select **[OK?]**, then press **DISP SETUP**.

Tip To cancel resetting, select **[Cancel]**.

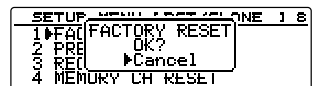

A beep sounds and the call sign input display appears on the screen.



- 5 Input the call sign.

Input the call sign using the numeric key pad. See “Input characters” on page 20 for instruction on inputting the call sign characters.

- 6 Press **DISP SETUP**.

Sets the call sign and displays the frequency screen.

Caution

Performing the All Reset function clears all information registered to the memory channels. Be sure to write memory data down on paper or back up the data on a microSD memory card. For instructions on saving the data onto a backup microSD memory card, see “Setup menu operations: 11 SD” on page 146.

Using the Memory

Frequently used frequencies and settings can be registered to the memory channels. The preset channels may be quickly recalled for convenient operation. The transceiver is also equipped with the following memory functions:

- Skip memory channels to preclude reception during scanning (☞ page 67)
- Scan only the specified memory channels (☞ page 67)
- “Programmable Memory Scan (PMS)” that scans only the specified frequency range (in the same frequency band) (☞ page 68)

The individual operating frequency and operating mode (modulation mode), as well as the other operating information, can be saved for each normal memory channel and PMS memory channel.

- Operating frequency
- Repeater information
- Memory skip information
- Modulation mode*
- Tone information
- Transmit power
- Memory tag
- DCS information

*Digital mode and analog mode information are not stored in the memory.

Registering to the memory channel

Caution

The information registered to the memory channel may be lost due to incorrect operation, static electricity or electrical noise. Data may also be lost due to component failures and repairs. Make sure to write down the information registered to the memory channels on a piece of paper or save the data to a backup microSD card.

A total of 500 memory channels are available for each of the A-band and B-band.

- 1 Switch to VFO mode.
- 2 Rotate the DIAL to tune to the desired frequency.
Select the frequency you want to register to a memory channel.

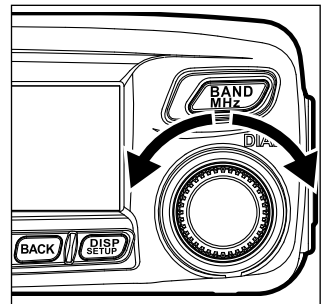

Using the Memory

- 3 Press and hold **V/M MW** for over one second.

The MEMORY WRITE screen appears.

The frequency automatically appears on an empty memory channel.

Tips • For details on how to assigning a nametag to a memory channel, see steps 4 to 12 in “Naming a memory channel” on page 56.

• To specify a specific memory channel, follow step 4 in “Specifying memory channels” on page 66.

• To set memory channels to skip, follow step 4 in “Setting memories to skip” on page 67.

- 4 Rotate the DIAL to select the desired memory channel.

Tip Pressing **TXPO** briefly each time skips memory channels in steps of 100 memory channels.

- 5 Press **DISP SETUP**.

Completes memory registration and displays the frequency and the memory channel number on the screen.

Tips • The frequency which has been registered to a memory channel can be overwritten with a new frequency.

• Press **V/M MW** to return to VFO mode.

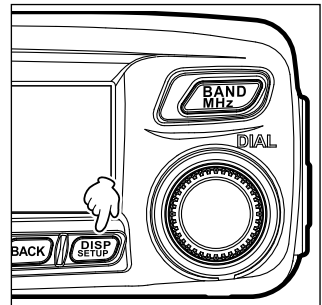
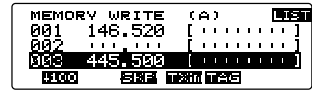
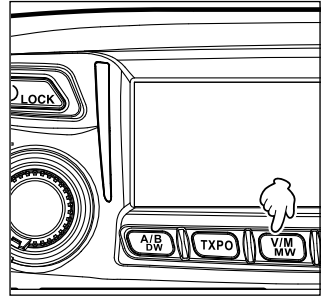

Tips

- When shipped from the factory, the frequency in memory channel 1 of A-band is set to 144.000 MHz whereas the frequency in memory channel 1 of B-band is set to 430.000 MHz. These can be changed to other frequencies but cannot be erased.
- Names can also be assigned to the memory channels. See “Naming a memory channel” on page 56.
- 9 pairs of PMS memory channels can be written for the A-band and B-band each. See “Scanning the programmable memories (PMS)” on page 68.

Recalling memories

- 1 Press **V/M MW**.

Switches to memory mode. The most recently used memory channel appears on the screen.



- 2 Rotate the DIAL to select the desired memory channel.
Press **V/M** again to return to VFO mode.

Tip

Unused memory channels are skipped.

Recalling the home channel

- 1 Press **[P2]** on the microphone.
The home channel appears on the screen.
Tip Change the frequency by rotating the DIAL to return to VFO mode.

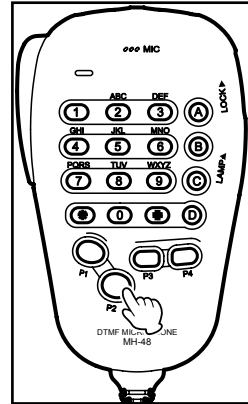

Press **[P2]** again to return to VFO mode and display the frequency that was selected before the home channel was recalled.

Tip

When shipped from the factory, the home channel of 144 MHz band is set to 144.000 MHz while the home channel of 430 MHz band is set to 430.000 MHz.

Changing the frequency of the home channel

The default frequency setting of the home channel can be changed.

- 1 Switch to VFO mode.
- 2 Rotate the DIAL to tune to the desired home channel frequency.
- 3 Press and hold **V/M MW** for over one second.
The MEMORY WRITE screen appears.

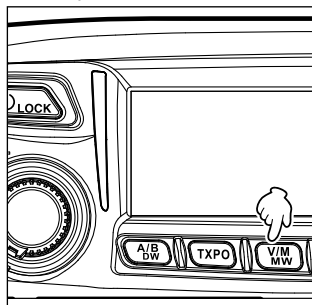

- 4 Rotate the DIAL to select **[HOME]**.

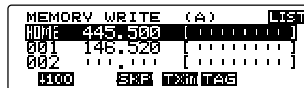

- 5 Press **DISP SETUP**.
The overwrite confirmation screen appears.

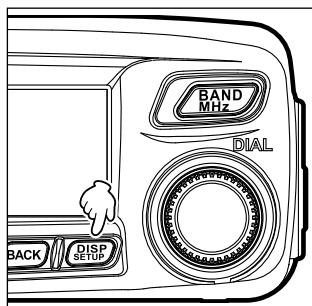

- 6 Rotate the DIAL to select **[OK?]**, and then press **DISP SETUP**.



The home channel frequency is overwritten, and the new home channel frequency is displayed.

Tip To cancel overwriting, select **[Cancel]**, then press **DISP SETUP**.

Clearing memories

- Press and hold **V/M MW** for over one second.
The MEMORY WRITE screen appears.
- Press **BAND MHz**, (**LIST** appears on the left side).
- Rotate the DIAL to select the memory channel from which memories are to be cleared.
- Press **Gv**, (**DEL** appears on the upper side).
The erase confirmation screen appears.
- Rotate the DIAL to select **[OK?]**, then press **DISP SETUP**.
Erases the memory and clears the display.

Tips

 - Select **[Cancel]**, then press **DISP SETUP** to cancel the memory deletion.
 - Repeat steps 3 to 5 to clear memories from other channels.

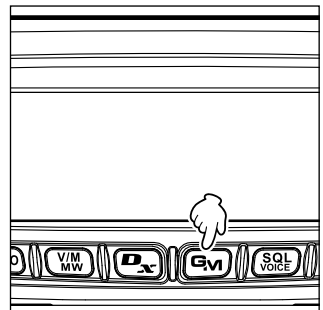
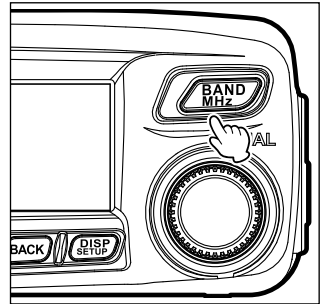
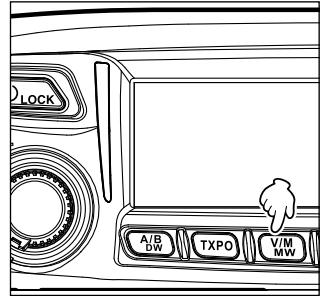

Caution

Memories on memory channel 1 and the home channel cannot be deleted.

- 6 Press **BACK**.

The display is returned to the previously viewed screen.

Naming a memory channel

Names (memory tags) such as call signs and the names of the broadcasting stations can be assigned to the memory channels and the home channel.

Up to 8 of the following characters can be entered as a memory tag.

- Alphabet (capital/small letters), numbers, symbols

Example: Assigning a name like “YM Grp01”

- 1 Press and hold **V/M MW** for over one second.

The MEMORY WRITE screen appears.

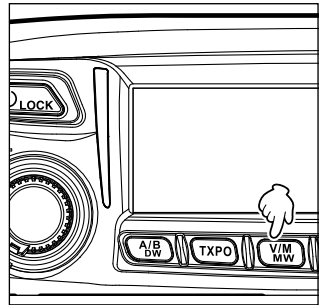

- 2 Press **BAND MHz**, (**LIST** appears on the left side).

- 3 Select the memory channel that is to be assigned a name.

Tip To assign a name to the home channel, recall the home channel.



- 4 Press **SQL VOICE**, (**TAG** appears on the upper side).

The cursor jumps to the left end of [| | | | |] on the right side of the frequency display.

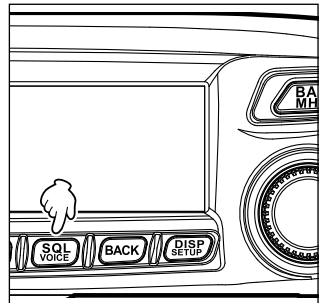

- 5 Rotate the DIAL to select [Y], then press **GM** (→ appears on the upper side).

“Y” is entered, and the cursor moves to the right.

Tip To delete the letter, press **VIM MW** (**CLR** appears on the upper side).



- 6 Rotate the DIAL to select [M], then press **GM** (→ appears on the upper side).

“M” is entered, and the cursor moves to the right.

Tips

- To move the cursor to the left, press **Dx** (← appears on the upper side).
- To delete the letter you have just entered and move the cursor to the left, press **SOL VOICE** (←X appears on the upper side).

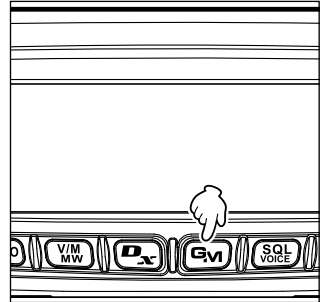

- 7 Press **TXPO** twice (A/E appears on the upper side).

The symbols input screen appears.

- 8 Rotate the DIAL to select “space”, then press **GM** (→ appears on the upper side).

A space is entered, and the cursor moves to the right.

- 9 Press **TXPO** (A/E appears on the upper side).
Upper case letters can be entered.

- 10 Rotate the DIAL to select [G], then press **GM** (→ appears on the upper side).

“G” is entered, and the cursor moves to the right.

- 11 Press **TXPO** 3 times (A/E appears on the upper side).
Lower case letters can be entered.

- 12 Rotate the DIAL to select [r], then press **GM** (→ appears on the upper side).
“r” is entered, and the cursor moves to the right.

- 13 Rotate the DIAL to select [p], then press **GM** (→ appears on the upper side).
“p” is entered, and the cursor moves to the right.

- 14 Press **TXPO** 4 times (A/E appears on the upper side).
The numbers input screen appears.

- 15 Rotate the DIAL to select [0], then press **GM** (→ appears on the upper side).
“0” is entered, then the cursor moves to the right.

- 16 Rotate the DIAL to select [1].
“1” is entered.

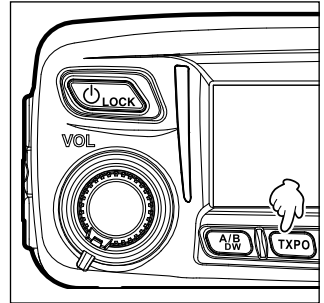

Using the Memory

17 Press .

The entered name appears on the right side of the screen.



18 Press .

The entered name is registered to the memory channel and the display returns to the previous operating screen. The entered memory tag appears.



Displaying the memory tag

The frequency and name tag display format can be selected for each channel.

1 Press and hold for over one second.

The Setup menu appears.

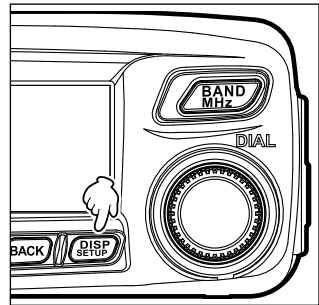

2 Rotate the DIAL to select [3 MEMORY], then press .

The menu list appears.

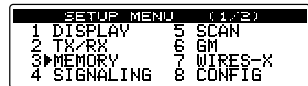

3 Rotate the DIAL to select [1 ALPHA TAG SIZE], then press .

The setting options appear.



4 Rotate the DIAL to select the desired display size.

“1 LARGE”: Displays the memory tag in large letters.

“2 SMALL”: Displays the memory tag in small letters.

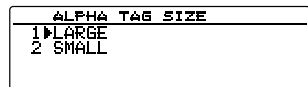

Tip The default setting: 2 SMALL

5 Press and hold for over one second.

The display size is set, and the display returns to the previous operating screen.

Tip You can also switch the display by pressing and holding  for over one second instead of following the procedure above.

LARGE

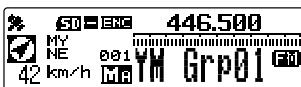

SMALL



Split memory

A separate transmit frequency may be registered to a memory channel to which a receive frequency has already been registered.

1 In VFO mode, select the transmit frequency to be registered.

2 Press and hold **V/M** for over one second.

The MEMORY WRITE screen appears.

The entered transmit frequency automatically appears on the next blank memory channel.

3 Rotate the DIAL (if necessary) to select the memory channel to which the transmit frequency is to be registered.

Tip Pressing **TXPO** briefly skips memory channels in steps of 100 memory channels.

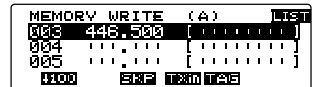
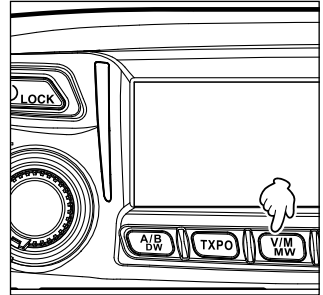

4 Press **Gv**, (**TXin** appears on the upper side).

The confirmation screen appears.

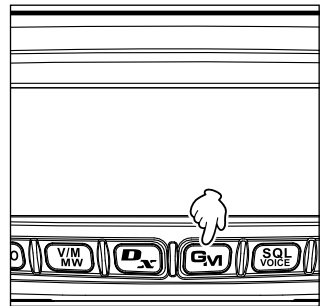

5 Rotate the DIAL to select **[OK?]**, then press **DISP SETUP**.

Registers the transmission frequency, then displays the memory mode screen.

Tip **E** appears on the left side of a memory channel when a separate transmit frequency is registered. Also, when such a memory channel is selected, **E** appears on the screen.



Receiving Weather Broadcast Channels (USA version only)

This radio includes the preprogrammed VHF Weather Broadcast Station Memory Channel Bank, and can receive the broadcast or the weather alert by recalling or scanning a desired channel.

The following channels are stored in the weather station memory bank of this radio.

Channel No.	Frequency	Channel No.	Frequency
WX01	162.550 MHz	WX06	162.500 MHz
WX02	162.400 MHz	WX07	162.525 MHz
WX03	162.475 MHz	WX08	161.650 MHz
WX04	162.425 MHz	WX09	161.775 MHz
WX05	162.450 MHz	WX10	163.275 MHz

This “WX” function can only be used through the programmable keys [P1] to [P4] on the microphone.

Assigning the “WX” function to a programmable key on the microphone

- Press and hold **DISP SETUP** for over one second.
The Setup menu appears.
- Rotate the DIAL to select **[8 CONFIG]**, then press **DISP SETUP**.
- Rotate the DIAL to select **[10 MIC PROGRAM KEY]**, then press **DISP SETUP**.
The microphone program key setting screen appears.
- Rotate the DIAL to select the program key ([P1] to [P4]) where the WX function is going to be assigned, then press **DISP SETUP**.
- Rotate the DIAL to select **[WX]**, then press **DISP SETUP**.
- Press and hold **DISP SETUP** for over one second.
The display returns to the previously viewed operating screen.

Recalling the weather channels

Example: When “WX” is assigned to [P1]

- Press **[P1]** on the microphone.
The WX function is activated, and the weather channel selected last time the WX function was activated will be displayed on the screen.
- Rotate the DIAL to select the other channels.
- Press the **[PTT]** on the microphone to search for louder stations.
Scanning of the channels stored in the weather station memory bank will start.
When the scanning pauses on a station, press the **[PTT]** once to halt the scan, or press it twice to restart the scan.
- Press the **[PTT]** to finish the scan.
- Press **[P1]**.

The WX function will be inactivated and returns the display to the previous viewed screen.

Listening the weather alert

In the event of extreme weather disturbances, such as storms and hurricanes, the NOAA (National Oceanic and Atmospheric Administration) sends a weather alert accompanied by a 1050 Hz tone and subsequent weather report on one of the NOAA weather channels. You may disable to receive the weather alert tone using **[4 SIGNALING] → [10 WX ALERT]** in the Setup menu.

Searching for signals

The FTM-100DR is equipped with a scanning function to search for memory channels and frequencies with active signals.

Scanning can be performed using the following 5 methods:

- VFO scan
Scan in VFO mode.
- All Memory Channel Scan
Scan for all memory channels.
- Select Memory Channel Scan
Scan for the specified memory channels.
- Skip Memory Channel Scan
Skip the specified memory channels when scanning.
- Programmable Memory Channel Scan (PMS)
Scan for the programmable memories.

VFO scan

- 1 Select the band to be scanned, and then switch to VFO mode.
- 2 Press and hold **[UP]** or **[DWN]** on the microphone for over one second.

Pressing **[UP]** scans in the higher frequency direction.

Pressing **[DWN]** scans in the lower frequency direction.

During scanning, the decimal point of the frequency display blinks.

Once the transceiver receives a signal, the transceiver continuously receives it until the signal disappears, and restarts scanning 2 seconds after the signal disappears.

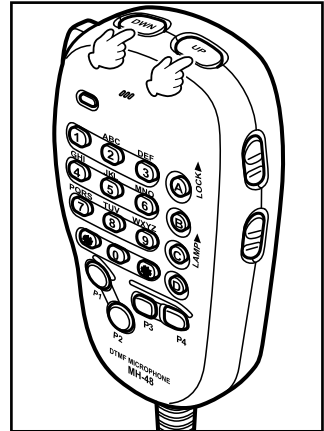

- Tips**
- The scanning direction (UP/DOWN) can be set from **[5 SCAN]** → **[2 SCAN DIRECTION]** in the Setup menu. This scanning direction setting is applied for scanning performed by pressing one of the **[P1]** to **[P4]** keys on the microphone to which **[SCAN]** is assigned in advance from **[8 CONFIG]** → **[10 MIC PROGRAM KEY]** in Setup menu.
 - The scanning direction can be changed by pressing and holding **[UP]** or **[DWN]** on the microphone for over one second, or by rotating the DIAL while scanning.
 - The operation performed after the scan stops on a signal, can be set from **[5 SCAN]** → **[3 SCAN RESUME]** in the Setup menu (refer to the next page).
 - The squelch level can be adjusted even during scanning, by pressing **[SQL VOICE]**, and then rotating DIAL.

● **Canceling scanning**

Press **[PTT]** on the microphone to cancel scanning (this does not put the transceiver into transmit mode).

■ **Selecting the receiver operation performed after scanning stops**

Select one of the following 3 receiving operations to be performed after the scanning stops.

- (1) Restart scanning after receiving the frequency for the set amount of time. Select from 1, 3 or 5 seconds.
- (2) Continue receiving the frequency until the signal disappears, and then restart scanning 2 seconds after the signal disappears (BUSY).
- (3) Stop scanning and receive that frequency (HOLD).

1 Press and hold **[DISP SETUP]** for over one second.
The Setup menu appears.

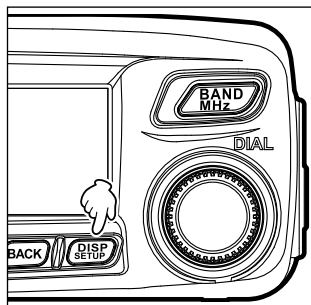

2 Rotate the DIAL to select **[5 SCAN]**, then press **[DISP SETUP]**.
The menu list appears.

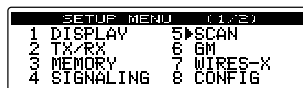

3 Rotate the DIAL to select **[3 SCAN RESUME]**, then press **[DISP SETUP]**.
The options for receiver operation appear.

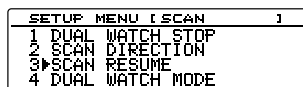

4 Rotate the DIAL to select the desired receiver operation, then press **[DISP SETUP]**.
“1 BUSY” → “2 HOLD” → “3 1sec” → “4 3sec” → “5 5sec”

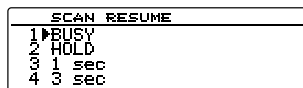

Tip The default setting: 1 BUSY

5 Press and hold **[DISP SETUP]** for over one second.
The receiver scanning operation is set, and the display returns to the previous operating screen.

Tip

The settings here are applied for “VFO Scan”, “Memory Scan” and “Programmable Memory Scan”.

Memory scan

Frequencies registered to the memory channels can be scanned in the memory channel number order.

- 1 Switch to memory mode.
- 2 Press and hold **[UP]** or **[DWN]** on the microphone for over one second.

Pressing **[UP]** scans the memory channels in an upward direction.

Pressing **[DWN]** scans the memory channels in a downward direction.

During scanning, the decimal point of the frequency display blinks.

Once the transceiver receives a signal, the transceiver continuously receives it until the signal disappears, and restarts scanning 2 seconds after the signal disappears.

- Tips**
- The scanning direction (UP/DOWN) can be set from **[5 SCAN]** → **[2 SCAN DIRECTION]** in the Setup menu. (This direction setting is also applied to scanning performed using one of the **[P1]** to **[P4]** keys on the microphone. The **[SCAN]** function can be assigned to the key in advance using **[8 CONFIG]** → **[10 MIC PROGRAM KEY]** in Setup menu).
 - The scanning direction can be changed by pressing and holding **[UP]** or **[DWN]** for over one second on the microphone or rotating the DIAL during scanning.
 - The receiver operation after scanning stops can be set from **[5 SCAN]** → **[2 SCAN RESUME]** in the Setup menu (refer to the previous page).
 - Press **(SQL VOICE)**, and then rotate the DIAL to adjust the squelch level, even during scanning.

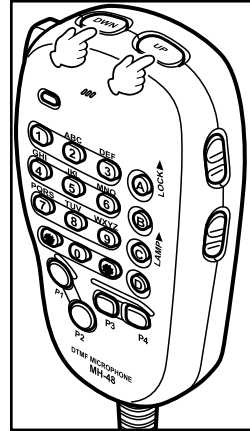

● Canceling scanning

To cancel scanning, press **[PTT]** on the microphone (this does not put the transceiver into transmit mode).

Selecting the scanning method

To scan all memory channels or only the specified memory channels.

- 1 Press and hold **DISP SETUP** for over one second.
The Setup menu appears.

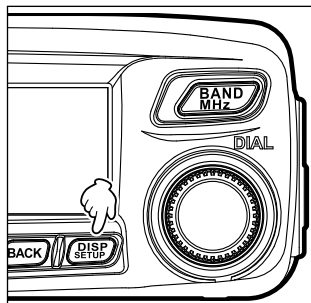

- 2 Rotate the DIAL to select **[3 MEMORY]**, and then press **DISP SETUP**.

The menu list appears.

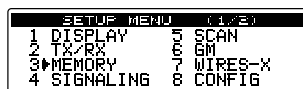

- 3 Rotate the DIAL to select **[2 MEMORY SCAN TYPE]**, then press **DISP SETUP**.

The setting options appear.



- 4 Rotate the DIAL to select the desired option.

1 ALL MEMORY:

Scans all memories.

2 SELECT MEMORY:

Scans only specified memories.

Tip The default setting: 1 ALL MEMORY

- 5 Press and hold **DISP SETUP** for over one second.

Sets the scanning method and returns the display to the previously operating screen.



Specifying memory channels

Specific memory channels to be scanned may be selected using the Setup menu “2 MEMORY SCAN TYPE” set to “2 SELECT MEMORY”.

- 1 Press and hold **V/M MW** for over one second.
The MEMORY WRITE screen appears.

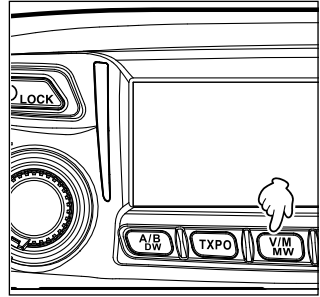

- 2 Press **BAND MHz**, (**LIST** appears on the left side).

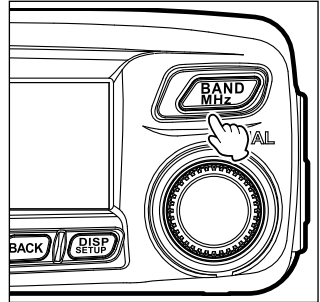

- 3 Rotate the DIAL to select the desired memory channel.



- 4 Press **DISP** twice, (**SWP** appears on the upper side).

On the right side of the memory channel number display, “▶” lights up. This indicates the “SELECT” state. The memory channels marked with this indicator are scanned when scanning only specified channels.

- Tips**
- To unselect the memory channel, press the button again. “▶” turns off.
 - To specify other memory channels, repeat steps 3 to 4.

- 5 Press **DISP SETUP**.

The previous screen returns and “▶” is displayed on the left side of the memory channel number.



Scanning only the specified memory channels

- 1 Select the band to be scanned, and then switch to memory mode.
- 2 Press and hold **DISP SETUP** for over one second.
The Setup menu appears.
- 3 Rotate the DIAL to select **[3 MEMORY]**, then press **DISP SETUP**.
The menu list appears.
- 4 Rotate the DIAL to select **[2 MEMORY SCAN TYPE]**, then press **DISP SETUP**.
The menu list appears.
- 5 Rotate the DIAL to select **[2 SELECT MEMORY]**.
- 6 Press and hold **DISP SETUP** for over one second.
The display is returned to the previously viewed screen.
- 7 Press and hold **[UP]** or **[DWN]** on the microphone for over one second.
Scanning of the specified memory channels begins.

- Tips**
- Pressing **[UP]** scans in the memory channel numbers in the upward direction, whereas pressing **[DWN]** scans the memory channel numbers in the downward direction.
 - To cancel scanning, press **[PTT]** on the microphone (this does not put the transceiver into transmit mode).

Setting memories to skip

Memory channels which you do not want to receive can be skipped during scanning.

- 1 Press and hold **V/M MW** for over one second.
The MEMORY WRITE screen appears.

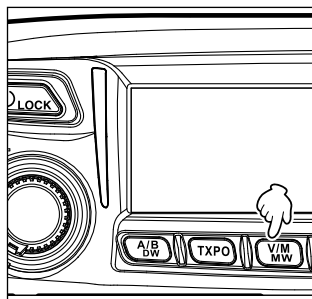

- 2 Press **BAND MRZ**, (**LIST** appears on the left side).
- 3 Rotate the DIAL to select the desired memory channel.



Searching for signals

- 4 Press **Dx**, (**SKIP** appears on the upper side).

On the right side of the memory channel number display, “▶” blinks. This indicates the “SKIP” state. The memory channels with this indicator are skipped during scanning.

```
MEMORY CH LIST(A)
001 148.500 [■■■■■■■■]
002 445.500 [■■■■■■■■]
003 445.500 [■■■■■■■■]
1100 TRF SKP DEL TAG
```

- Tips** • To unselect the memory channel, press **Dx** twice. “▶” turns off.
• To set other memory channels, repeat steps 3 to 4.

- 5 Press **DISP SETUP**.

The display returns to the previously viewed screen. “▶” blinks on the left side of the memory channel number.

Scanning the programmable memories (PMS)

Using the dedicated PMS memory channels, only the frequencies within the specified frequency range will be scanned.

Register the desired frequency range to the PMS memory channels in advance.

Registering to the programmable memory channels

9 pairs (LP1/UP1 to LP9/UP9) of frequencies can be entered to the PMS memory channels.

Register the lower limit of the desired scanning frequency range to the memory channel “LP*” and the upper limit to the memory channel “UP*”.

One pair of PMS memories with the same channel number “*” (a number from 1 to 9) are handled as one PMS channel “P*”.

Example: Set up a PMS channel by registering a lower frequency of 433.200 MHz and an upper frequency of 433.700 MHz to the P1 (LP1/UP1) memory channel.

- 1 Switch to VFO mode.
- 2 Rotate the DIAL tune to the desired lower limit scan frequency.
Tune in to the frequency to set for the lower limit (433.200 MHz).

Caution The frequency entered as the lower limit (LP1) must be lower than the upper limit (UP1).

- 3 Press and hold **V/M MW** for over one second.
The MEMORY WRITE screen appears.

- 4 Rotate the DIAL to select **[LP1]**.

Tip A name tag may also be assigned to each memory channel (page 56).

```
MEMORY WRITE (A) LIST
LP1 445.500 [■■■■■■■■]
UP1 ..... [■■■■■■■■]
LP2 ..... [■■■■■■■■]
1100 SKP TRF TAG
```

- 5 Press **DISP SETUP**.

The display returns to the previous screen and shows the registered frequency and memory channel number.

- 6 Press **V/M MW** to switch to VFO mode.

7 Rotate the DIAL to tune to the desired upper scanning limit frequency.
Tune in to the frequency to set for the upper limit (433.700 MHz).

8 Press and hold **[V/M WW]** for over one second.
The MEMORY WRITE screen appears.

9 Rotate the DIAL to select **[UP1]**.

Tip A name tag may also be assigned to each memory channel (see page 56).

10 Press **[DISP SETUP]**.

The display returns to the previous operating screen, and shows the registered frequency and memory channel number.

Lower limit frequency LP1

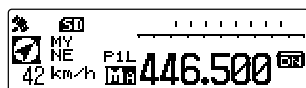

Upper limit frequency UP1



Scanning the programmable memory channels

1 Press **[V/M WW]** to switch to memory mode.

2 Recall the upper or lower frequency PMS memory channel.

3 Press and hold **[UP]** or **[DWN]** on the microphone for over one second.

Programmable memory scanning will begin.

Tips • To cancel programmable memory scanning, press **[PTT]** on the microphone (this does not cancel PMS mode).

• To cancel PMS mode, when programmable memory scanning stops, press **[V/M WW]**.

• The squelch level can be adjusted using the following procedure even while scanning.
Press **[SQL VOICE]**. → Rotate the DIAL.

Caution

If the upper and lower PMS frequencies are not set correctly, the programmable memory scan will not function.

Tip You can assign **[SCAN]** to one of the **[P1]** to **[P4]** keys on the microphone using the Setup MENU **[8 CONFIG]** → **[10 MIC PROGRAM KEY]**. For details on assigning a function to the **[P1]** to **[P4]** keys, see “Setting the program keys on the microphone (10 MIC PROGRAM KEY)” on page 138. For operations using **[P1]** to **[P4]**, refer to the following.

1 Press **[V/M WW]** to switch to memory mode.

2 Recall the upper or lower frequency PMS memory channel.

3 Press one of the **[P1]** to **[P4]** keys on the microphone to which **[SCAN]** is assigned.

Monitoring the home channel

The FTM-100DR transceiver is equipped with a dual receive function (also known as dual watch (DW)) which periodically checks for signals on the home channel. When a signal is detected, the transceiver receives on the home channel.

Example: While receiving signals on 446.500 MHz, dual receive checks the home channel every 5 seconds.

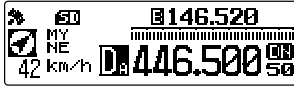

Receiving frequency

Monitors the home channel at intervals of about 5 seconds.



After receiving a signal on the home channel, the transceiver continues receiving until the signal disappears. About 3 seconds after the signal disappears, the dual reception starts again.

Caution

When shipped from the factory, the 144 MHz band home channel is set to 145.000 MHz, while the 430 MHz band home channel is set to 433.000 MHz. The registered home channel frequencies may be changed as desired. (☞ page 54).

Using the dual receive function

- 1 Rotate the DIAL to tune to a memory channel or VFO receive frequency.
- 2 Press and hold A/B for over one second.

The dual receive function is activated and the home channel is checked approximately every 5 seconds. When a signal is detected on the home channel, reception continues until the signal disappears.

The time interval for checking the home channel may be changed in the Setup menu [5 SCAN] → [4 DUAL WATCH MODE] (page 71).

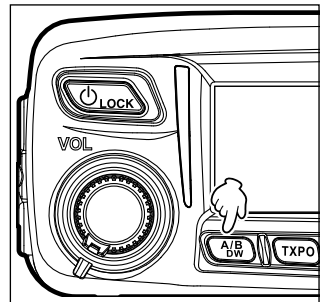

● Canceling the dual receive function

Press and hold A/B again for over one second.

Setting the dual receive restart setting

Set how the transceiver dual receive mode operates after the signal on the home channel disappears by selecting one of the following 2 options:

- (1) Restarts dual receive operation in 3 seconds (AUTO).
- (2) Stops dual reception and continues receiving signals on the home channel (HOLD).

- 1 Press and hold **(DISP SETUP)** for over one second.

The Setup menu appears.

- 2 Rotate the DIAL to select **[5 SCAN]**, and then press **(DISP SETUP)**.

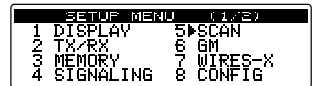

- 3 Rotate the DIAL to select **[1 DUAL WATCH STOP]**, then press **(DISP SETUP)**.

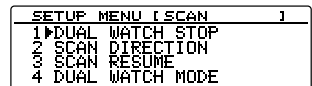

The setting options appear.

- 4 Rotate the DIAL to select the desired setting.

Select "1 AUTO" or "2 HOLD".

Tip The default setting: 1 AUTO



- 5 Press and hold **(DISP SETUP)** for over one second.

Sets the dual reception restart setting and returns the display to the previously viewed screen.

Setting the channel signal reception time when using the dual reception function

Set the time interval to check the HOME channel when using the dual reception function.

- 1 Press and hold **(DISP SETUP)** for over one second.

The Setup menu appears.

- 2 Rotate the DIAL to select **[5 SCAN]**, and then press **(DISP SETUP)**.

The menu list appears.

- 3 Rotate the DIAL to select **[4 DUAL WATCH MODE]**, then press **(DISP SETUP)**.

The setting options appear.

- 4 Rotate the DIAL to select the time interval to check the home channel.

Select one from [0.3sec] to [10sec].

Tip The default setting: 5.0 sec

Supplement The HOME channel reception time is fixed to 0.3sec.

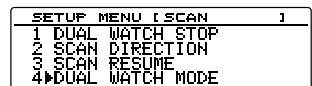
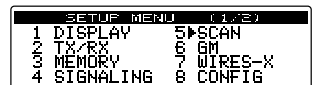

- 5 Press and hold **(DISP SETUP)** for over one second.

Sets the time interval to check the Home channel and returns the screen to the previously viewed screen.

Using the GPS Function

The FT-100DM transceiver is equipped with an internal GPS reception unit to receive and display the location information at all times. The location information can be used for the following purposes:

Save the location information of other stations and note whether or not they are within communication range.

☞ Refer to the separate GM Function Instruction Manual.

Exchange the location information and messages with other stations, during data communications.



☞ Refer to the separate APRS Instruction Manual.

What is GPS?

GPS (Global Positioning System) is a space-based satellite navigation system that provides location and time information anywhere on the earth. It was developed by the U.S. Department of Defense as a military system. It receives signals from 3 or more of about 30 GPS satellites flying at an altitude of about 20,000 km, and displays the current position (latitude, longitude, altitude) within an accuracy of several meters. In addition, GPS can receive the exact time from the satellite's onboard atomic clock. The transceiver is equipped with a high-sensitivity 66-channel GPS antenna supporting QZSS (Quasi-Zenith Satellite System) which shortens measuring time and improves the accuracy of the location information.

Activating the GPS function

- 1 Press and hold  for over one second.

Starts satellite search and displays the  icon at the top left of the screen. Upon acquiring the satellites, the  icon blinks.

- Tips**
- It may take several minutes to acquire the satellites.
 - When 3 or more satellites cannot be acquired, the  icon keeps blinking. Under this circumstance, positioning is not possible and thus location information cannot be utilized.

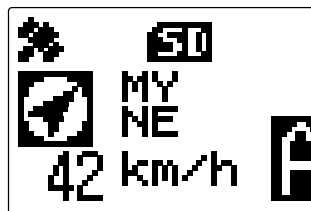

About GPS positioning

“Positioning” refers to the calculation of the GPS receiver position from the satellite orbit information, and the propagation time of the radio waves. For successful positioning, at least 3 satellites must be acquired. If positioning is unsuccessful, move the GPS receiver to an open space, as far from buildings as possible, where the view of the sky is unobstructed.

• About errors

Environmental obstacles may cause positioning errors of several hundred meters. Under favorable conditions, positioning can be performed successfully using only 3 satellites. However, under the following poor conditions, the positioning accuracy may decrease or cause positioning to fail.

- Between high-rise buildings
- Indoors or under the shade of buildings
- Between trees in a forest or woods
- When used behind a solar energy-reflecting glass
- Narrow roads between buildings
- Beneath high-voltage lines or overhead structures
- Inside a tunnel or underground
- Areas with strong magnetic fields

• When the GPS is not in use for an extended period of time

Locating satellites may take several minutes when using the GPS function for the first time after purchase or when you have not used the transceiver for an extended time. Similarly, when several hours have passed since turning off the transceiver, a several minute wait may be required in order to locate the satellites.

Checking the satellite acquisition status

The satellites acquired at the current location and the strength of the signals can be observed on the radar-like screen.

1 Press **DISP** **SETUP** twice briefly.

Displays the radar-like GPS screen, and the acquired satellite numbers and signal strength using a chart.

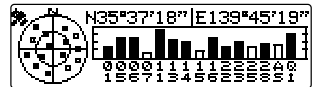

- indicates non-acquired satellites, whereas
- indicates acquired satellites.

The location information of your station (longitude and latitude) is also shown above the signal strength chart.

- Tips**
- Pressing **DISP** **SETUP** again returns the display to the previously viewed screen.
 - In the Setup menu [1 DISPLAY] → [4 GPS INFORMATION], you can change the display above the signal strength chart to the frequency display.

Displaying the location information

Displaying your current location information

On the normal screen, the current location information of your station is displayed on the left side of the frequency display. The screen displays the compass indicating the direction you are heading in and your station movement speed.



Displaying location information of the received station in digital mode

In C4FM digital V/D mode, the GPS location information and voice signals are transmitted simultaneously. Therefore, the direction and location of the received station can be calculated and displayed in real-time, even while communicating.

- 1 Press **DISP SETUP** once briefly.

Displays the current location information of the received station on the left side of the frequency display. The screen displays the compass indicating the direction to the received station and the distance to the received station.



Tip

In the Setup menu **[10 APRS]** → **[11 APRS UNITS]**, you can change the display unit for each type of data.

Saving location information (GPS Log Function)

Your location information can be periodically saved onto a microSD memory card.

- 1 Press and hold **DISP SETUP** for over one second.

Displays the Setup menu.

- 2 Rotate the DIAL to select **[8 CONFIG]**, then press

DISP SETUP.

Displays the menu list.

- 3 Rotate the DIAL to select **[17 GPS LOG]**, then press

DISP SETUP.

Displays the screen for switching the GPS log function between ON and OFF and selecting the interval time for saving location points.

- Tip** When "OFF" is selected, the location information is not saved.

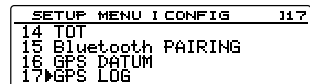
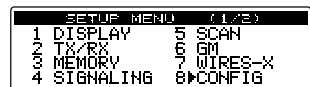

- 4 Rotate the DIAL to select [1 ON [xx sec]], then press



Tip The default setting: 2 OFF



- 5 Rotate the DIAL to select the interval for saving the location information.

“1 sec”, “2 sec”, “5 sec”, “10 sec”, “30 sec”, “60 sec”

Tip The default setting: 10 sec

- 6 Press and hold for over one second.

Sets the interval for saving the location information and returns the display to the previously viewed screen. The icon lights up on the screen.

Starts saving the location information at the set interval.

Tips

- The location information is periodically saved until the power to the transceiver is switched OFF or when “OFF” is selected in step 4.
Saving of location information resumes under the same file name when the transceiver is turned OFF and then ON again within the same day, or when the saving interval is selected again in step 5.
- The data is saved under the filename “GPSyymmdd.log”.
The portion “yymmdd” indicates the saving start time in “yy” (year), “mm” (month), and “dd” (day).

Checking the route using a personal computer

The route can also be displayed on a computer with commercially available mapping software using the log data of the saved location information.

- 1 Turn off the transceiver.
- 2 Remove the microSD card.
Tip Refer to “Removing the microSD memory card” on page 32.
- 3 Insert the microSD memory card into the personal computer using an appropriate memory card reader.

- 4 Open the “FTM100D” folder located on the microSD memory card.

- 5 Open the “GPSLOG” folder.

The data is saved under the filename “GPSyymmdd.log”.

The portion “yymmdd” indicates the saving start time in “yy” (year), “mm” (month), and “dd” (day).

- 6 Import the data into the mapping software.

The route will be displayed on the map.

Tips

- Refer to the operating manual of the mapping software for instructions on how to import and display the route data on the map.
- The location information can also be used by connecting the transceiver directly to a computer. See “Connecting an external device” on page 108.

Other settings

● Changing the geodetic reference system

Set the geodetic reference in the Setup menu, **[8 CONFIG]** → **[16 GPS DATUM]**.

You can select the geodetic reference system-positioning standard:

“1 WGS-84”: Use the global geodetic reference system for positioning. This is the standard used all around the world.

“2 TOKYO MEAN”: Use the Japanese geodetic reference system for positioning. Reduces the chance of inaccuracies while positioning in Japan (Tokyo).

Tips

- When the geodetic reference system is changed to “TOKYO MEAN”, the location information will deviate by about 400 meters.
- For normal usage, keep it set to “WGS-84”.

● Changing the time zone

Set the time zone differential in the Setup menu **[8 CONFIG]** → **[3 TIME ZONE]**.

The time difference with the UTC (Coordinated Universal Time) can be changed in 30-minute steps.

Using the APRS Function

What is the APRS (Automatic Packet Reporting System) function?

For amateur radios, there are several functions that display location information using GPS, however the APRS is a data communication system that transmits data such as location information and messages using the format developed by Bob Bruninga of WB4APR.

Upon receiving an APRS signal from another station, information such as: the direction and distance to that station from your station; the speed of the station; the identity and other information may be displayed on the screen of your transceiver.



When using the APRS function, station information such as the call sign and symbol of your own station need to be set in the APRS initial setup menus. For details, refer to the APRS Instruction Manual (download from Yaesu website).

Using the GM Function

What is the GM (Group Monitor) Function?

The GM function automatically monitors for any other stations with the GM function in operation on the same frequency, or stations transmitting in DN mode, within communication range. The GM function then displays the acquired information, including the direction and distance, on the screen for each detected call sign. In addition to notifying you of the GM group members within your communication range, the GM function also displays the relative positions of all the members in the group on the transceiver screen. Furthermore, the GM function may also be used to exchange data such as messages and images between group members.

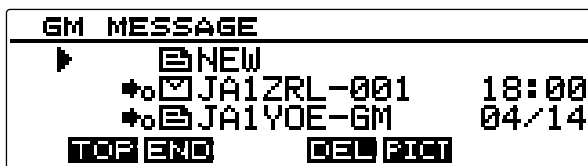
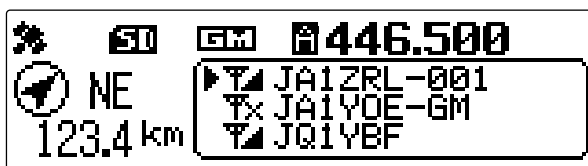

Tips

- The GM function does not work while in the analog mode. When the GM function is activated, the operating band automatically switches to DN mode.
- When sending an image with the GM function in operation, the operating band automatically switches to FR mode (high-speed data communication mode). Upon completion of the data transmission, the mode automatically reverts to the original V/D mode (simultaneous voice/data communication mode).



How to use the GM function

The GM function enables the display of all stations operating the GM function (up to 24 stations). For detailed information about the operation and functions of the GM mode, refer to the separate GM Function Instruction Manual (download from Yaesu website).

● **Displaying all the stations that are transmitting in the GM function**

- 1 Tune to the designated frequency on the operating band.
- 2 Press **GM**.

The GM function activates and displays up to 24 stations transmitting in the GM mode on the same frequency, or stations running in DN mode, within the communication range.

- Tips**
- Displays  for stations within your communication range.
 - Displays  for stations outside your communication range.

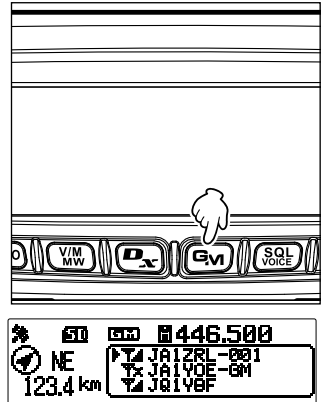

Using the WIRES-X Function

What is the WIRES-X Function?

The WIRES-X is a system that links to other users via the Internet. This function enables users to communicate with other users world wide, regardless of the distance.

When the transceiver is connected to WIRES-X, the call signs of other stations and rooms on the WIRES-X are displayed.



To establish a WIRES-X node station, the WIRES-X connection kit "HRI-200" sold separately is required. For details, refer to the separate WIRES-X Instruction Manual (download from the Yaesu website).

Communicating with specific stations

Using the tone squelch function

This radio is equipped with the CTCSS (Continuous Tone-coded Squelch System which allows audio to be heard only when receiving signals containing the same frequency tone as the tone that has been set in the tone squelch menu. By matching the tone frequency with the partner station in advance, a quiet standby monitoring is possible.

Caution

CTCSS does not function in digital modes. To transmit a signal using a CTCSS code, use the  key to switch the communication mode to AMS (Auto Mode Select function) or analog (FM) mode.

Selecting the tone frequency

The tone frequency can be selected from 50 frequencies (from 67.0 Hz to 254.1 Hz).

- 1 Press and hold  for over one second.
The Setup menu appears.

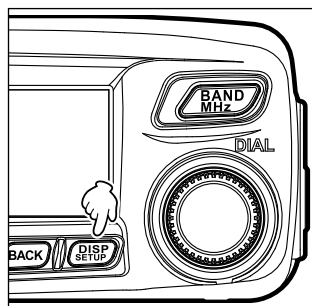

- 2 Rotate the DIAL to select [4 SIGNALING], then press .
The menu list appears.

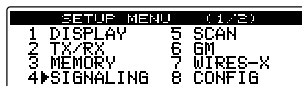

- 3 Rotate the DIAL to select [1 TONE SQL FREQ], then press .

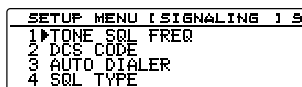

- 4 Rotate the DIAL to select the desired frequency.

Tip The default setting: 100.0 Hz

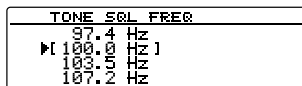

- 5 Press and hold  for over one second.

Sets the tone frequency and returns the display to the previously viewed screen.

Tip You can also return to the previous screen by pressing  3 times.

Using the tone squelch function

- 1 Press and hold **DISP SETUP** for over one second.
The Setup menu appears.

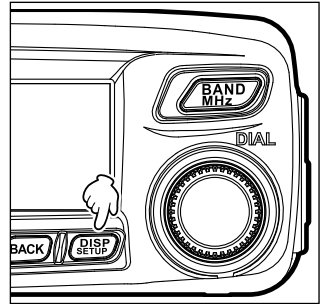

- 2 Rotate the DIAL to select **[4 SIGNALING]**, then press **DISP SETUP**.
The menu list appears.

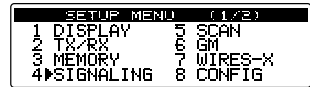

- 3 Rotate the DIAL to select **[4 SQL TYPE]**, then press **DISP SETUP**.

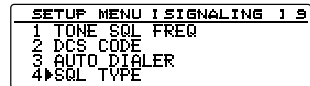

- 4 Rotate the DIAL to select **[TONE SQL]**, then press **DISP SETUP** for over one second.

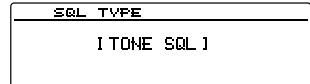

Tips • Rotating the DIAL changes the squelch type in the following order:

“OFF”, “TONE ENC”, “TONE SQL”, “REV TONE”, “DCS”, “PR FREQ”, “PAGER”, “DCS ENC”*, “TONE DCS”*, “DCS TSQL”*

*To display these squelch types, from the Setup menu, select **[4 SIGNALING]** → **[9 SQL EXPANSION]** followed by “1 ON”.

- Instead of following the steps 1 to 4 above, you can change the squelch type by pressing and holding **TXPO** for over one second.

Displays **TSQ** on the screen. The squelch opens only when receiving tone signals of the set frequency.

Tip

A bell tone (beep) may be set to sound when signals containing a corresponding CTCSS tone are received. See “Notification of incoming calls from partner stations using the bell function” on page 89.

Transmitting tone signals

- 1 Press and hold **DISP SETUP** for over one second.
The Setup menu appears.

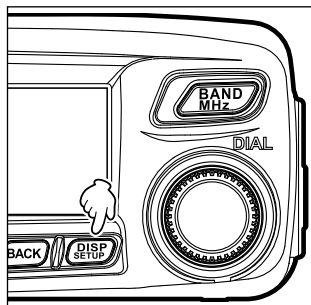

- 2 Rotate the DIAL to select **[4 SIGNALING]**, then press **DISP SETUP**.
The menu list appears.

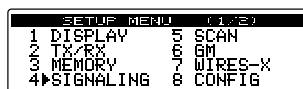

- 3 Rotate the DIAL to select **[4 SQL TYPE]**, then press **DISP SETUP**.

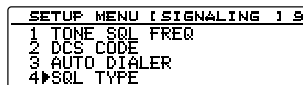

- 4 Rotate the DIAL to select **[TONE ENC]**, then press **DISP SETUP** for over one second.

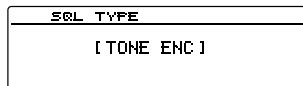

Tips • Rotating the DIAL changes the squelch type in the following order:

“OFF”, “TONE ENC”, “TONE SQL”, “REV TONE”, “DCS”, “PR FREQ”, “PAGER”, “DCS ENC”*, “TONE DCS”*, “DCS TSQL”*

*The squelch types may also be selected from the Setup menu, select **[4 SIGNALING]** → **[9 SQL EXPANSION]** followed by “1 ON”.

- Instead of following the steps 1 to 4 above, the squelch type may be selected by pressing and holding **TXPO** for over one second.

Displays **ENC** on the screen.

- 5 Press **[PTT]** on the microphone.

While pressing and holding **[PTT]**, the signal containing the designated tone is transmitted.

Using the digital code squelch function

This radio is equipped with a DCS (Digital Coded Squelch) function that allows audio to be heard only when signals containing the corresponding DCS code are received. By matching the DCS code with the partner stations beforehand, a quiet receive standby is possible.

Caution

DCS does not function in digital mode. To transmit a signal with a DCS code, use the **[Dx]** key to switch the communication mode to AMS (Auto Mode Select function) or analog mode (FM).

Selecting the DCS code

The DCS code can be selected from 104 digital codes between 023 and 754.

- 1 Press and hold **[DISP SETUP]** for over one second.
The Setup menu appears.

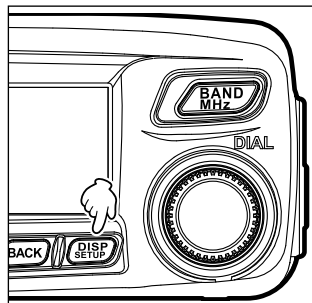

- 2 Rotate the DIAL to select **[4 SIGNALING]**, then press **[DISP SETUP]**.
The menu list appears.

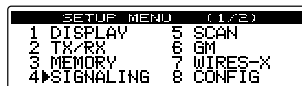

- 3 Rotate the DIAL to select **[2 DCS CODE]**, then press **[DISP SETUP]**.



- 4 Rotate the DIAL to select the desired DCS code.

Tip The default setting: 023

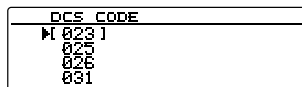

- 5 Press and hold **[DISP SETUP]** for over one second.

Sets the DCS code and returns the display to the previously viewed screen.

Tip You can also return to the previous screen by pressing **[BACK]** 3 times.

Using the DCS function

- 1 Press and hold **DISP SETUP** for over one second.
The Setup menu appears.

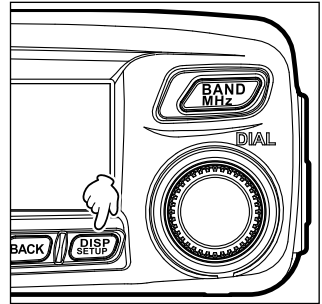

- 2 Rotate the DIAL to select **[4 SIGNALING]**, then press **DISP SETUP**.
The menu list appears.

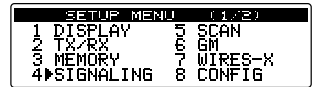

- 3 Rotate the DIAL to select **[4 SQL TYPE]**, then press **DISP SETUP**.

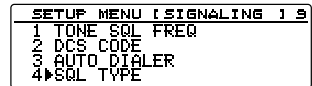

- 4 Rotate the DIAL to select **[DCS]**, then press **DISP SETUP** for over one second.

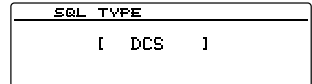

Tips • Rotating the DIAL changes the squelch type in the following order:

“OFF”, “TONE ENC”, “TONE SQL”, “REV TONE”, “DCS”, “PR FREQ”, “PAGER”, “DCS ENC”*, “TONE DCS”*, “DCS TSQL”*

*To display these squelch types, from the Setup menu, select **[4 SIGNALING]** → **[9 SQL EXPANSION]** followed by “1 ON”.

- Instead of following the steps 1 to 4 above, the squelch type may be changed by pressing and holding **TXPO** for over one second.

Displays **DCS** on the screen.

The squelch opens only when receiving a signal containing the corresponding DCS code.

Tip

A bell tone (beep) may be set to sound when signals containing a corresponding DCS code are received. See “Notification of incoming calls from partner stations using the bell function” on page 89.

Using the new pager function

Use the pager code consisting of 2 CTCSS tones to exchange communications with specified stations.

Caution

The new pager does not function in digital mode. To transmit signals utilizing the pager codes, use the  key to switch the communication mode to AMS (Auto Mode Select function) or analog (FM) mode.

Setting the transceiver pager code

- 1 Press and hold  for over one second.
The Setup menu appears.

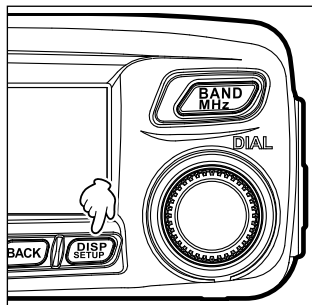

- 2 Rotate the DIAL to select **[4 SIGNALING]**, then press .
The menu list appears.

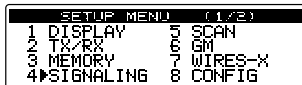

- 3 Rotate the DIAL to select **[6 PAGER CODE]**, then press .
The pager setting screen appears.

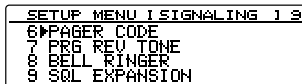

- 4 Rotate the DIAL to select **[RX CODE 1]**, then press .
The code blinks.

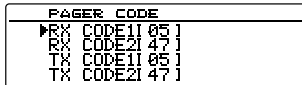

- 5 Rotate the DIAL to select the desired code, and then press .
Select the first part of the code from 01 to 50.

Tip The default setting: 05

- 6 Rotate the DIAL to select **[RX CODE 2]**, then press .
The code blinks.

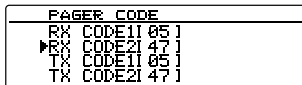

- 7 Rotate the DIAL to select the code, and then press .
Select the second part of the code from 01 to 50.

Tip The default setting: 47

- 8 Press and hold **DISP SETUP** for over one second.

Sets your station pager code and returns the display to the previously viewed screen.

Tip You can also return to the previous screen by pressing **BACK** 3 times.

Tips

- Even if the first and second parts of the pager code are reversed, for example, [47 05] from [05 47], they are still recognized as the same code.
- If multiple stations set the same pager code, they can be called simultaneously.

Activating the new pager function

- 1 Press and hold **DISP SETUP** for over one second.

The Setup menu appears.

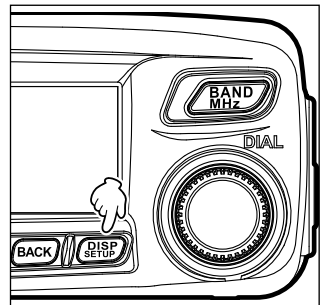

- 2 Rotate the DIAL to select **[4 SIGNALING]**, then press **DISP SETUP**.

The menu list appears.

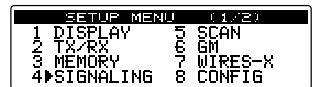

- 3 Rotate the DIAL to select **[4 SQL TYPE]**, then press **DISP SETUP**.

The menu list appears.

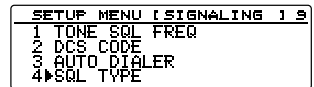

- 4 Rotate the DIAL to select **[PAGER]**, then press **DISP SETUP** for over one second.

The menu list appears.

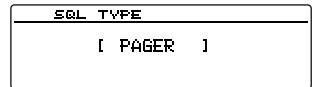

Tips • Rotating the DIAL changes the squelch type in the following order:

“OFF”, “TONE ENC”, “TONE SQL”, “REV TONE”, “DCS”, “PR FREQ”, “PAGER”, “DCS ENC”*, “TONE DCS”*, “DCS TSQL”*

*To display these squelch types, from the Setup menu, select **[4 SIGNALING]** → **[9 SQL EXPANSION]** followed by “1 ON”.

- Instead of following the steps 1 to 4 above, the squelch type may be changed by pressing **TXPO** and holding **TXPO** for over one second.

Displays **PRG** on the screen.

The operating band enters standby mode for receiving in the pager mode.

Calling a specific station

- 1 Press and hold **DISP SETUP** for over one second.
The Setup menu appears.

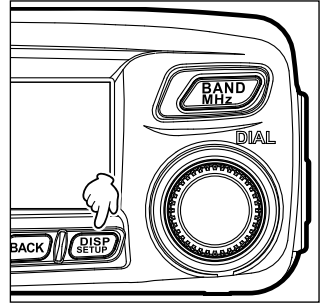

- 2 Rotate the DIAL to select **[4 SIGNALING]**, then press **DISP SETUP**.
The menu list appears.

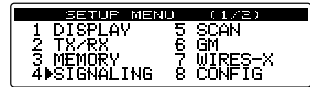

- 3 Rotate the DIAL to select **[6 PAGER CODE]**, then press **DISP SETUP**.
The code setting screen appears.

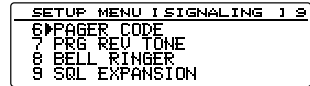

- 4 Rotate the DIAL to select **[TX CODE 1]**, then press **DISP SETUP**.
The code blinks.

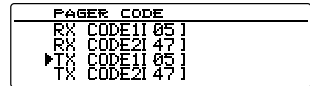

- 5 Rotate the DIAL to select the desired code, then press **DISP SETUP**.
Select the first part of the code from 01 to 50.

Tip The default setting: 05

- 6 Rotate the DIAL to select **[TX CODE 2]**, then press **DISP SETUP**.
The code blinks.

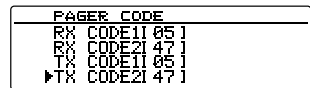

- 7 Rotate the DIAL to select the code, then press **DISP SETUP**.
Select the second part of the code from 01 to 50.

Tip The default setting: 47

- 8 Press and hold **DISP SETUP** for over one second.

Sets the partner station code and returns the display to the previously viewed screen.

Tip You can also return to the previous screen by pressing **BACK** 3 times.

- 9 See “Activating the new pager function” on page 87 to activate the PAGER function.

- 10 Press **[PTT]** on the microphone.
Calls the partner station.

Notification of incoming calls from partner stations using the bell function

While communicating using the tone squelch, DCS, or new pager function, a beep may be programmed to sound when a signal containing the corresponding code is received.

- 1 Press and hold **DISP SETUP** for over one second.
The Setup menu appears.

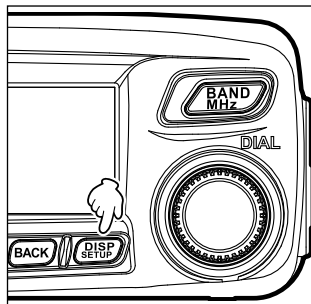

- 2 Rotate the DIAL to select **[4 SIGNALING]**, then press **DISP SETUP**.
The menu list appears.

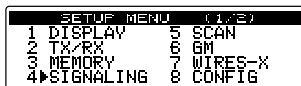

- 3 Rotate the DIAL to select **[8 BELL RINGER]**, then press **DISP SETUP**.

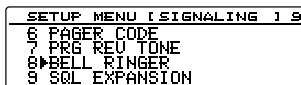

- 4 Rotate the DIAL to select the desired number of successive bell rings.
"1 OFF", "2 1 time", "3 3 times", "4 5 times", "5 8 times", "6 CONTINUOUS"

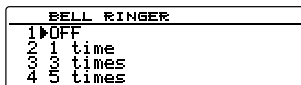

Tip The default setting: 1 OFF

- 5 Press and hold **DISP SETUP** for over one second.

Sets the selected beep setting and returns the display to the previously viewed screen.

Tip You can also return to the previous screen by pressing **BACK** 3 times.

Other squelch functions

● Reverse tone

In Setup menu, select **[4 SIGNALING]** → **[4 SQL TYPE]** followed by **[REV TONE]**.

Using the Reverse Tone System, a tone is transmitted when there is no audio. When audio is transmitted on the signal, the tone is not transmitted.

The reverse tone frequency may be set in 100Hz intervals from 300Hz – 3000Hz (default 1500Hz) using the set-up menu **[4 SIGNALING]** → **[7 PRG REV TONE]**

● User Programmed Reverse CTCSS Decoder

In Setup menu, select **[4 SIGNALING]** → **[4 SIGNALING]** → **[PR FREQ]**.

The user programmable Reverse CTCSS Decoder will mute the FTM-100DR receiver when a signal containing a matching CTCSS tone is received.

● DCS transmission

From the Setup menu, select **[4 SIGNALING]** → **[4 SQL TYPE]** followed by **[DCS ENC]**.

The DCS code is sent during transmission.

To use this function, from the Setup menu, select **[4 SIGNALING]** → **[9 SQL EXPANSION]** followed by “1 ON”.

● CTCSS tone transmission / DCS code tone reception

From the Setup menu, select **[4 SIGNALING]** → **[4 SQL TYPE]** followed by **[TONE DCS]**.

The CTCSS tone is sent during transmission. In standby mode, the receiver waits for the matching DCS code signal to open the receiver audio.

To use this function, from the Setup menu, select **[4 SIGNALING]** → **[9 SQL EXPANSION]** followed by “1 ON”.

● DCS code transmission / CTCSS tone reception

From the Setup menu, select **[4 SIGNALING]** → **[4 SQL TYPE]** followed by **[DCS TSQL]**.

The DCS code is sent during transmission. In standby mode, the receiver waits for the matching CTCSS tone signal to open the receiver audio.

To use this function, from the Setup menu, select **[4 SIGNALING]** → **[9 SQL EXPANSION]** followed by “1 ON”.

Using the DTMF function

DTMF tones (Dual Tone Multi Frequencies) are the tones you hear when dialing from a telephone keypad. The FTM-100DR transceiver can transmit the DTMF codes by using the keys on the microphone or recalling registered numbers from memories.

The maximum of 16-digit DTMF codes can be registered in up to 9 memory channels. It is convenient to register telephone patch numbers, and network linking sequences to the DTMF memory channels.

Tip

Transmits the DTMF code consisting of frequencies shown as follows.

	1209Hz	1336Hz	1477Hz	1633Hz
697Hz	1	2	3	A
770Hz	4	5	6	B
852Hz	7	8	9	C
941Hz	*	0	#	D

Registering the DTMF code

- Press and hold **DISP SETUP** for over one second.
The Setup menu appears.
- Rotate the DIAL to select **[4 SIGNALING]**, then press **DISP SETUP**.
The menu list appears.
- Rotate the DIAL to select **[5 DTMF MEMORY]**, then press **DISP SETUP**.
The DTMF memory screen appears.
- Rotate the DIAL to select the desired memory channel to register the DTMF code, and then press **DISP SETUP**.
The cursor jumps to the left end of [| | | | | | |] displayed on the right.
- Rotate the DIAL to select the desired DTMF code, then press **Gv** (**←** appears on the upper side).
Tip You can also use the keypad on the microphone to input the DTMF code.
- Repeat step 5.
Tips
 - To move the cursor to the left, press **Dx** (**←** appears on the upper side).
 - To delete the number you have just entered and move the cursor to the left, press **SQL VOICE** (**X** appears on the upper side).
- Press **DISP SETUP**.
Sets the DTMF code.

Tip To register DTMF codes to other channels, repeat steps 4 to 6.

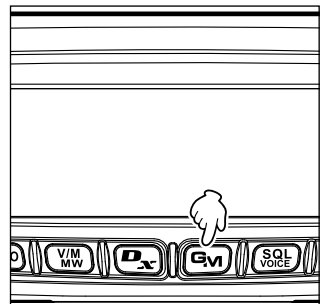
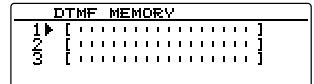
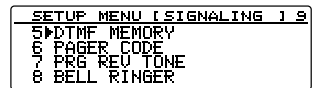
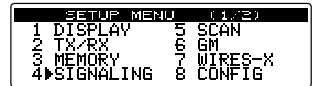

Using the DTMF function

- Press and hold **DISP SETUP** for over one second.

Sets the DTMF code and returns the display to the previously viewed screen.

Tip You can also return to the previous screen by pressing **BACK** 3 times.

Transmitting the registered DTMF code

- Press and hold **DISP SETUP** for over one second.

The Setup menu appears.

- Rotate the DIAL to select **[4 SIGNALING]**, then press **DISP SETUP**.

The menu list appears.

SETUP MENU (1/2)	
1 DISPLAY	5 SCAN
2 TX/RX	6 GM
3 MEMORY	7 WIRES-X
4 SIGNALING	8 CONFIG

- Rotate the DIAL to select **[3 AUTO DIALER]**, then press **DISP SETUP**.

The AUTO DIALER screen appears.

SETUP MENU SIGNALING 3	
1 TONE SQL FREQ	
2 DCS CODE	
3 AUTO DIALER	
4 SQL TYPE	

- Rotate the DIAL to select "1 ON".

Rotating the DIAL changes the function between "1 ON" and "2 OFF".

AUTO DIALER	
1 ON	
2 OFF	

- Press and hold **DISP SETUP** for over one second.

Returns the display to the previously viewed screen and displays **DTMF** on the top right side of the screen.

Tip You can also return to the previous screen by pressing **BACK** 3 times.

- While pressing and holding **[PTT]** on the microphone, use the number keys on the microphone to input the channel number to which the DTMF code is registered.

The DTMF code sequence is automatically transmitted.

- Release **[PTT]**.

While transmitting the DTMF code, transmission status is sustained even when **[PTT]** is pressed.

Transmitting the DTMF code manually

- Press and hold **DISP SETUP** for over one second.

The Setup menu appears.

- Rotate the DIAL to select **[4 SIGNALING]**, then press **DISP SETUP**.

The menu list appears.

SETUP MENU (1/2)	
1 DISPLAY	5 SCAN
2 TX/RX	6 GM
3 MEMORY	7 WIRES-X
4 SIGNALING	8 CONFIG

- Rotate the DIAL to select **[3 AUTO DIALER]**, then press **DISP SETUP**.

The AUTO DIALER screen appears.

SETUP MENU SIGNALING 3	
1 TONE SQL FREQ	
2 DCS CODE	
3 AUTO DIALER	
4 SQL TYPE	

- 4 Rotate the DIAL to select “2 OFF”.

Rotating the DIAL changes the function between “1 ON” and “2 OFF”.



- 5 Press and hold **DISP SETUP** for over one second.

Returns the display to the previously viewed screen and displays **DISP** on the top right side of the screen.

Tip You can also return to the previous screen by pressing **BACK** 3 times.

- 6 While pressing and holding **[PTT]**, press the desired DTMF characters (**[0]** to **[9]**, **[*]**, **[#]**, or **[A]** to **[D]**), sequentially on the microphone keypad.

- 7 Release **[PTT]**.

While transmitting the DTMF code, transmission status is sustained even when **[PTT]** is pressed.

Using the timer function

Using the APO function

When the APO (Automatic Power-off) function is set to ON, the transceiver automatically turns off if no operation is performed for the designated time. A beep sounds about one minute before the transceiver turns off. For example, when connecting the transceiver to your car battery, the APO function prevents accidental draining of the battery.

- 1 Press and hold **DISP SETUP** for over one second.

The Setup menu appears.

- 2 Rotate the DIAL to select **[8 CONFIG]**, then press

DISP SETUP.

The menu list appears.

SETUP MENU (1/2)	
1 DISPLAY	5 SCAN
2 TX/RX	6 GM
3 MEMORY	7 WIRES-X
4 SIGNALING	8 CONFIG

- 3 Rotate the DIAL to select **[13 APO]**, then press **DISP SETUP**.

Displays the screen where the remaining time until the power turns off is set.

SETUP MENU I CONFIG 11.7	
13 APO	
14 TDT	
15 Bluetooth PAIRING	
16 GPS DATUM	

- 4 Rotate the DIAL to select the desired remaining time from the following 14 options.

“0.5 hour”, “1.0 hour”, “1.5 hour”, “2.0 hour”, “3.0 hour”, “4.0 hour”, “5.0 hour”, “6.0 hour”, “7.0 hour”, “8.0 hour”, “9.0 hour”, “10.0 hour”, “11.0 hour”, “12.0 hour”

Tip When “OFF” is selected, the APO function does not activate.

APO	
1	0.5 hour 1

- 5 Press and hold **DISP SETUP** for over one second.

The APO function is activated and the display returns to the previously viewed screen.

Tip You can also return to the previous screen by pressing **BACK** 3 times.

Using the TOT function

By setting the TOT (Timeout Timer) function to ON, the transceiver automatically returns to receive after a transmission continues for the designated time. A beep sounds about 10 seconds before the transceiver returns to receive mode. The TOT prevents unintentional transmissions, interference to other communications and excessive battery power consumption.

- 1 Press and hold **DISP SETUP** for over one second.

The Setup menu appears.

- 2 Rotate the DIAL to select **[8 CONFIG]**, then press

DISP SETUP.

The menu list appears.

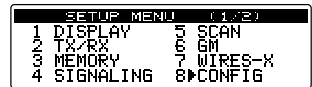

- 3 Rotate the DIAL to select **[14 TOT]**, then press **DISP SETUP**.

The screen is displayed where the time remaining until the transceiver returns to the receive mode may be set.

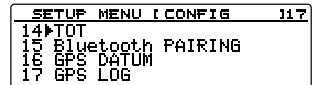

- 4 Rotate the DIAL to select the desired remaining time from the following 8 options.

“1 min”, “2 min”, “3 min”, “5 min”, “10 min”, “15 min”, “20 min”, “30 min”

Tip When “OFF” is selected, the TOT function does not activate.

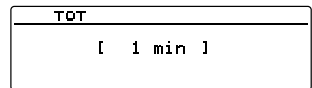

- 5 Press and hold **DISP SETUP** for over one second.

The TOT function is activated and the display returns to the previous operating screen.

Tip You can also return to the previous screen by pressing **BACK** 3 times.

Exchanging messages or images

While operating in digital mode, you can receive messages (text data) or images. Transmitted and received messages and images are all saved in the common list.

Cautions

- To receive a message or image, press to switch the communication mode to AMS (Automatic Mode Select Function) or digital mode in advance.
- When sending a message or image, the communication mode automatically switches to digital mode.
- To save images, insert a microSD memory card into the transceiver (see page 32).

Tips

There are three types of digital mode as follows. For details, see “Selecting communication mode” on page 39.

- V/D mode (simultaneous voice/data communication mode)
- Voice FR mode (voice full rate mode)
- Data FR mode (high speed data communication mode)

Viewing the message or image list

You can display the list of transmitted and received data. You can also select the desired data to check it.

- 1 Press and hold for over one second.
Displays “LOG SELECT” on the screen.

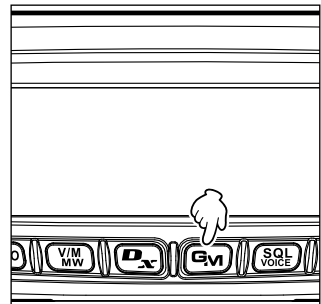

- 2 Rotate the DIAL to select [GM MESSAGE] or [GM PICT], then press .

When [GM MESSAGE] is selected, the “GM MESSAGE” screen appears.

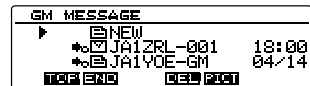



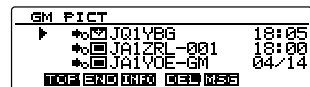



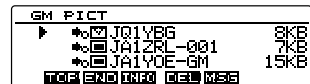









When [GM PICT] is selected, the “GM PICT” screen appears and the images and time stamps are listed.



Press (appears on the upper side) to switch the display to image size display. Pressing each time switches the display.



- Tips**
-  displayed on the left side of the icon indicates that the image was successfully received.
 - Icons on the left side of the LOG list indicate the following.

NEW	Creating and sending a new message
 	Message received (unread)
 	Message received (read)
 	Message sent
 	Message failed to send
 	Image received (unread)
 	Image received (read)
 	Image sent
 	Image failed to send

- The data most recently received is on the top of the list.
- Press **V/M MW** (**END** appears on the upper side) to jump to the bottom of the list.
When there are many files, it may take a while to jump to the bottom of the list. Press **[PTT]** to cancel the operation halfway.
- Press **TXPO** (**TOP** appears on the upper side) to jump to the top of the list.

3 Rotate the DIAL to select the data you want to check, then press **DISP SETUP**.

Displays the selected data.

4 Press **BACK** twice.

The display returns to the previously viewed operating screen.

Deleting messages or images

You can delete unnecessary messages and images from the microSD memory card.

Deleting data from the content display screen

- 1 Display the data you want to delete.
- 2 Press **GM** (**DEL** appears on the upper side)
Displays the confirmation screen.

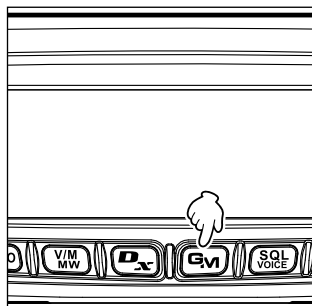

Exchanging messages or images

- 3 Rotate the DIAL to select [OK?], then press **[DISP SETUP]**.
Starts the deletion process.

After completing deletion, the display returns to the data list screen.

Rows move up by one.

Tip To cancel deletion, select [Cancel], then press **[DISP SETUP]**.



Deleting data from the list

- 1 From the data list, select the data you want to delete by rotating the DIAL.
- 2 Press **[GM]** (**[DEL]** appears on the upper side).
Displays the confirmation screen.

- 3 Rotate the DIAL to select [OK?], then press **[DISP SETUP]**.
Starts the deletion process.

After completing deletion, the display returns to the data list screen.

Rows move up by one.

Tip To cancel deletion, select [Cancel], then press **[DISP SETUP]**.



Downloading messages or images

When there is a message or image sent in digital mode from a station on the same operating frequency, the content of the message or image is displayed for a certain period of time on the transceiver screen. Message data can be downloaded to the memory of the transceiver and image data can be downloaded to the microSD memory card inserted into the transceiver.

When receiving a message



When receiving an image



Tips

- While receiving an image, sender's call sign and ">>>>" appear to indicate the reception progress of the data.
- If the message cannot be downloaded successfully due to unsupported file format or other reasons, "Not Completed" appears.
- If the image data cannot be downloaded to the microSD memory card successfully due to insufficient memory space, "Insufficient SD's Memory" appears.

Sending messages or images

Send messages or images from the transceiver. Sent data can be viewed by all stations operating in digital mode on the same frequency.

There are the following three ways for sending messages or images.

- (1) Creating and sending a new message
- (2) Replying to the sender of the downloaded message or image data
- (3) Forwarding the downloaded message or image data

Creating and sending a new message

Create a new message and send.

- 1 Press and hold **[GM]** for over one second.
Displays "LOG SELECT" screen.

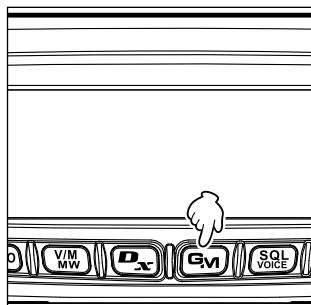

- 2 Rotate the DIAL to select **[GM MESSAGE]**, then press **[DISP SETUP]**.
Displays the "GM MESSAGE" screen.



- 3 Rotate the DIAL to select **[NEW]**, then press **[DISP SETUP]**.
- 4 Press **[TXPO]** (**[EDIT]** appears on the upper side)
Displays the message entry screen.



- 5 See "Input characters" on page 20 to input a message.

- 6 Press **[BACK]**
Displays the entire message.

- Tips**
- To save the created message press **[D-x]** (a menu icon appears on the upper side). For details, see "Registering routine messages" on page 101.
 - To continue message entry, press **[TXPO]** (**[EDIT]** appears on the upper side).

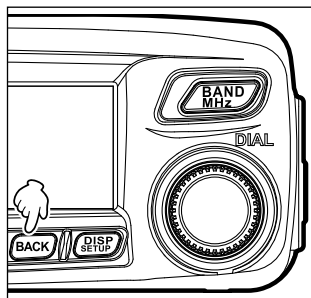

Exchanging messages or images

- 7 Press **SQL VOICE** (**SEND** appears on the upper side).

Sends the message.

Tip To cancel transmission, press **BACK**.

When message transmission completes, "Completed" appears and then the screen returns to the message list screen. The tag of the transmitted message is added to the top of the list.



Using routine message

The following 19 routine messages are stored on the transceiver at the time of factory shipment for quick input.

QRM	Good night
QRP	Send messages
QRT	Send pictures
QRX	on my way
QRZ	wait for you
QSY	Pick me up
Good morning	Thank you
Good job	OK
Good day	urgent
Good evening	

- 1 Follow the steps 1 through 3 of "Creating and sending a new message" on page 99 to display the message details screen.

- 2 Press **V/M MW** (**+ [MENU]** appears on the upper side)

The routine messages are displayed at the top of the screen.

Tip For "01" to "10", you can register a message comprising up to 16 letters. See "Registering routine messages" on page 101.

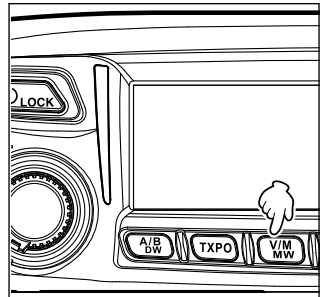

- 3 Rotate the DIAL to select the desired routine message, then press **DISP SETUP**.

Displays the selected routine message in the message entry field.

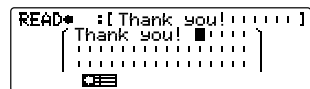
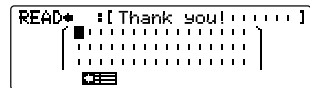

- 4 Press **V/M MW** (**+ [MENU]** appears on the upper side)
Hides the routine message display field at the top of the screen.



- To add letters to the message, input letters following steps 4 through 5 of “Creating and sending a new message” on page 99.

● **Registering routine messages**

You can register up to 10 routine messages using a maximum of 80 characters. Messages you registered can be selected and used in the same way as the 43 prepared routine messages.

- Follow steps 1 to 5 in “Creating and sending a new message” on page 99 to input a text message.

Tip Alphanumeric characters including symbols can be used.

- Press **BACK**

- Press **Ⓜ** (**☰** appears on the upper side).

Displays the routine message field at the top of the screen.

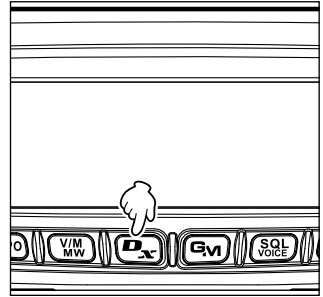

- Rotate the DIAL to select the number where you want to register the message, then press **DISP SETUP**.

Tip You can select a number from “01” to “10”.

Registers the text as a routine message and closes the routine message field.

Tips • If you register a new message to a number where a message already have registered, the old message is overwritten.

- To cancel registration, press **Ⓜ** again (**☰** appears on the upper side).



Replying to the sender of the downloaded message or image data

Reply to the sender of the checked message or image data.

- 1 Press and hold **[GM]** for over one second.
Displays the “LOG SELECT” screen.
- 2 Rotate the DIAL to select **[GM MESSAGE]** or **[GM PICT]**, then press **[DISP SETUP]**.



When **[GM MESSAGE]** is selected, the “GM MESSAGE” screen appears.

When **[GM PICT]** is selected, the “GM PICT” screen appears.

- 3 Rotate the DIAL to select the data you want to reply to, then press **[DISP SETUP]**.
Displays the selected data.

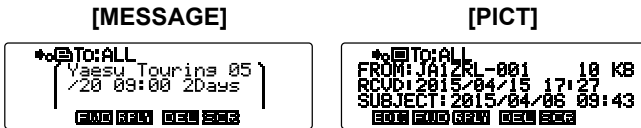

- 4 Press **[R]** (**[RPLY]** appears on the upper side).
Displays the message entry screen.
- 5 Enter the reply message.
See “Creating and sending a new message” on page 99 to enter the reply message.

Tips

- When replying, the call sign of the MESSAGE/PICT data sender is automatically specified for “to:”.
- In other words, even if you specify the data sender’s call sign (name) for “to:” to reply, other stations operating GM on the same frequency can still view the message or image as long as they are within the communication range.

- 6 Press **[BACK]**.
Displays the entire message.
- 7 Press **[SQL VOICE]** (**[SEND]** appears on the upper side).
Sends the message. When message or image transmission completes, “Completed” appears and then the screen returns to either the message list screen or image list screen.

Forwarding the downloaded message or image data

You can forward the checked message or image data.

- 1 Press and hold **[GM]** for over one second.
Displays the “LOG SELECT” screen.



- 2 Rotate the DIAL to select **[GM MESSAGE]** or **[GM PICT]**, then press **[DISP SETUP]**.

When **[GM MESSAGE]** is selected, the “GM MESSAGE” screen appears.

When **[GM PICT]** is selected, the “GM PICT” screen appears.

- 3 Rotate the DIAL to select the data you want to forward, then press **[DISP SETUP]**.



Displays the selected data.

[MESSAGE]



[PICT]



- 4 Press **[V/M MW]** (**[FWD]** appears on the upper side).
“SEND ”to: ALL”” appears.

- 5 Rotate the DIAL to select **[OK?]**, then press **[DISP SETUP]**.

Sends the message or image. When message or image transmission completes, “Completed” appears and then the screen returns to either the message list screen or image list screen.

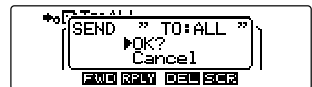

Copying the radio data to another transceiver

The memory channels and settings in the set-up menu can be copied to another FTM-100DR transceiver. This is convenient, for example, to configure the transceiver to match to the settings of stations that you communicate with frequently.

Using a microSD memory card

The data files saved in the FTM-100DR can be selected and copied to a microSD memory card which may then be used to transfer the data to other FTM-100DR transceivers.

Copying data to a microSD memory card

- 1 Insert a microSD memory card into the transceiver.

Tip See "Inserting a microSD memory card" on page 32.

- 2 Press and hold **DISP SETUP** for over one second.

The Setup menu appears.

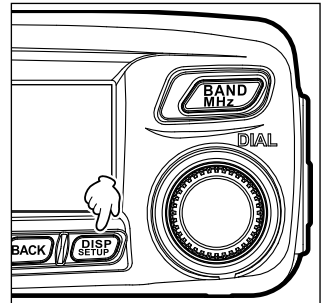

- 3 Rotate the DIAL to select **[11 SD]**, then press **DISP SETUP**.

The menu list appears.

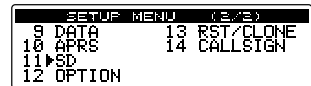

- 4 Rotate the DIAL to select **[1 BACKUP]**, then press **DISP SETUP**.

Displays the screen where you can select the copy direction.



- 5 Rotate the DIAL to select **[1 Write to SD]**, then press **DISP SETUP**.

The screen is displayed where the type of data to be transferred is selected.

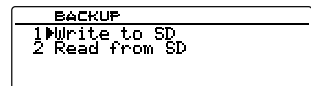

"1 ALL": Copies all data in the transceiver.

"2 MEMORY": Copies only information registered to the memory channels.

"3 SETUP": Copies only settings in the Setup menu.

- 6 Rotate the DIAL to select the data to be copied, and then press **DISP SETUP**.

The confirmation screen appears.

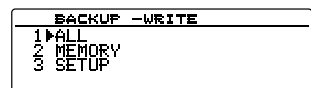

- 7 Rotate the DIAL to select **[OK?]**, and then press **(DISP SETUP)**.



The data selected in step 6 is copied to the microSD memory card. While copying, “Writing...” appears, and when completing, it disappears.

- 8 Press and hold **(DISP SETUP)** for over one second.

The display returns to the previously viewed operating screen.

Copying data from the microSD memory card

- 1 Insert the microSD card into the FTM-100DR transceiver from which data is to be copied, and then copy the data to the card.
- 2 Remove the microSD card and insert it into the FTM-100DR transceiver to which the data is to be copied.
- 3 Press and hold **(DISP SETUP)** for over one second.

The Setup menu appears.

- 4 Rotate the DIAL to select **[11 SD]**, then press **(DISP SETUP)**.
The menu list appears.

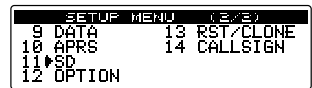

- 5 Rotate the DIAL to select **[1 BACKUP]**, then press **(DISP SETUP)**.

Displays the screen where the copy direction may be selected.



- 6 Rotate the DIAL to select **[2 Read from SD]**, then press **(DISP SETUP)**.

Displays the screen where the data type may be selected.

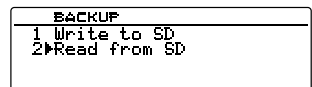

- 7 Rotate the DIAL to select the desired data type, then press **(DISP SETUP)**.

1 ALL: Copies all data in the transceiver.

2 MEMORY: Copies only information registered to the memory channels.

3 SETUP: Copies only settings in the Setup menu.

4 MEMORY (Import FTM-400DR):

Copies the memory channel data saved on the microSD memory card of the FTM-400DR transceiver.

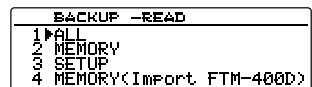

Caution Insert the microSD memory card to which the FTM-400DR transceiver memory channel data is copied, into the transceiver.

The confirmation screen appears.

Copying the radio data to another transceiver

- 8 Rotate the DIAL to select **[OK?]**, and then press **(DISP SETUP)**.

The data selected in step 7 is copied from the microSD memory card. While copying, “Reading...” appears, and when completing, it disappears.



Using the clone function

Using the clone function, all data saved in the transceiver can be copied directly to other FTM-100 transceivers.

Example: When using the clone function in two FTM-100DR transceivers

- 1 Turn off the both transceivers.
- 2 Connect the optional clone cable “CT-166” to the DATA jack on the rear side of the transceivers.

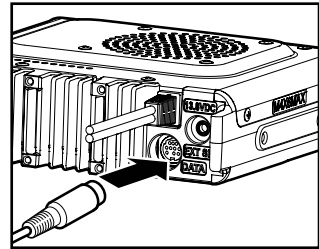

- 3 Turn on both transceivers.
- 4 Press and hold **(DISP SETUP)** for over one second. The Setup menu appears.
- 5 Rotate the DIAL to select **[13 RST/CLONE]**, then press **(DISP SETUP)**. The menu list appears.

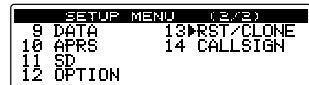

- 6 Rotate the DIAL to select **[7 CLONE]**, then press **(DISP SETUP)**. Displays the screen where the copy direction may be selected.

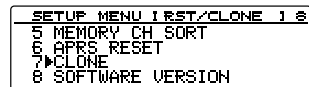

- 7 On the transceiver from which data is to be copied, rotate the DIAL to select **[1 This radio → other]**, then press **(DISP SETUP)**. The confirmation screen appears.

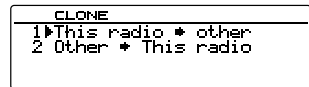

- 8 On the transceiver to which data is to be copied, rotate the DIAL to select **[2 Other → This radio]**, then press **(DISP SETUP)**. The confirmation screen appears.

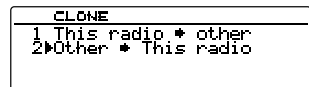

- 9 On the transceiver to which data is to be copied, rotate the DIAL to select **[OK?]**, then press **(DISP SETUP)**.



- 10** On the transceiver from which data is to be copied, rotate the DIAL to select **[OK?]**, then press **(DISP SETUP)**.

The data copy starts.

When data copy completes, "Completed" appears.

The FTM-100DR transceiver to which you copy the data restarts automatically. The screen displayed differs depending on the copied data.



- 11** On the transceiver from which data is to be copied, press and hold **(DISP SETUP)** for over one second.

The display returns to the previously viewed operating screen.

- 12** Turn off the both transceivers, then disconnect the clone cable.

Cautions

- When "ERROR" appears on the screen during the copy (clone) operation, the copy (clone) operation has not completed. Check the clone cable connection, and perform the operation from the beginning.
- To ensure the security of your data, it is recommended to copy your backup file onto a microSD memory card.
- If the operation is terminated due to power loss during the copy (clone) operation, the transceiver to which the data copies will be reset automatically. Check that there is no abnormality in the power supply and perform the operation again from the beginning.

Connecting an external device

Using the provided PC connection cable “SCU-20” or another optional cable, the transceiver can be connected to a personnel computer as a COM port for the following operations:

- Transferring GPS location data and import route mapping information into the computer software
- Updating the transceiver firmware
- Packet communication

The DATA jack on the rear side of the transceiver permits connecting external devices such as a computer. The pin assignment of the DATA jack is shown below.

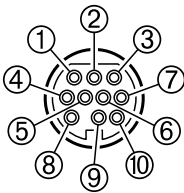

- ① PKD (packet data input)
- ② GND
- ③ PSK (PTT)
- ④ RX 9600 (9,600 bps packet data output)
- ⑤ RX 1200 (1,200 bps packet data output)
- ⑥ PK SQL (squelch control)
- ⑦ TXD (serial data output [transceiver → PC])
- ⑧ RXD (serial data input (transceiver ← PC))
- ⑨ CTS (data communication control)
- ⑩ RTS (data communication control)

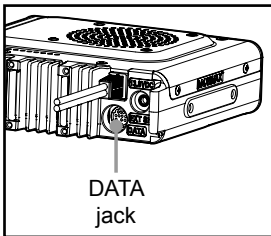

Connecting to a computer

● Preparation

- Computer
- PC connection cable “SCU-20” (supplied)... When connecting to the USB jack of the computer

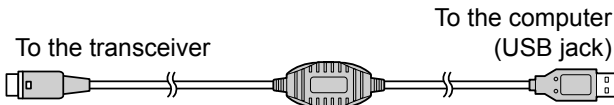

Tips

- Make sure to turn off the transceiver before connecting any cables.
- When using the SCU-20 PC connection cable, install the designated driver on the computer. Download the driver and installation manual from the Yaesu website.

- Data cable “CT-165” (optional)... When connecting to the RS-232C jack of the computer

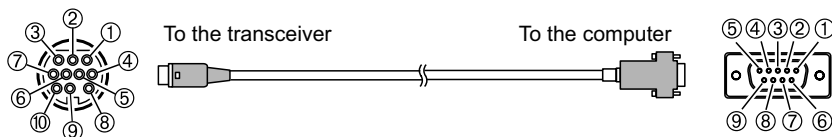

- ① -
- ② GND
- ③ -
- ④ -
- ⑤ -
- ⑥ -
- ⑦ TXD (serial data output [transceiver → PC])
- ⑧ RXD (serial data input [transceiver ← PC])
- ⑨ CTS (data communication control)
- ⑩ RTS (data communication control)

- ① -
- ② TXD (serial data output [transceiver → PC])
- ③ RXD (serial data input [transceiver ← PC])
- ④ -
- ⑤ GND
- ⑥ -
- ⑦ CTS (data communication control)
- ⑧ RTS (data communication control)
- ⑨ -

Tips

- Make sure to turn off the transceiver before connecting any cables.
- When using the SCU-20 PC connection cable, install the designated driver on the computer. Download the driver and installation manual from the Yaesu website.

Transmitting GPS location information

- 1 Turn on the transceiver.
- 2 Press and hold **DISP SETUP** for over one second.
The Setup menu appears.

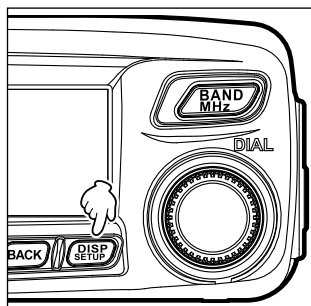

- 3 Rotate the DIAL to select **[9 DATA]**, then press **DISP SETUP**.
The menu list appears.

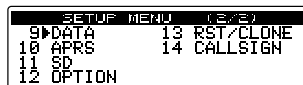

- 4 Rotate the DIAL to select **[1 COM PORT SETTING]**, then press **DISP SETUP**.
The detail settings screen appears.



Connecting an external device

- 5 Rotate the DIAL to select **[COM OUTPUT]**, then press .

```
COM PORT SETTING
COM SPEED | 9600bps |
▶COM OUTPUT| OFF   |
WP FORMAT | NMEA 9  |
WP FILTER | ALL   |
```

- 6 Rotate the DIAL to select “GPS OUT”, then press .

The setting changes in the following order.

“OFF” → “GPS OUT” → “PACKET” → “WAYPOINT”

Tip The default setting: OFF

- 7 Rotate the DIAL to select **[COM SPEED]**, then press .

```
COM PORT SETTING
▶COM SPEED | 9600bps |
COM OUTPUT| OFF   |
WP FORMAT | NMEA 9  |
WP FILTER | ALL   |
```

- 8 Rotate the DIAL to select the desired communication speed, then press .

The setting changes in the following order.

“4800 bps” → “9600 bps” → “19200 bps” → “38400 bps” → “57600 bps”

Tip The default setting: 9600bps

- 9 Press and hold  for over one second.

Returns the display to the previously viewed screen.

Transmits the location information data. Transmits the location information data to the computer at about one second intervals.

Tip

To use this information, software operating with NMEA-0183 specified GGA and RMC sentence is required.

Updating the transceiver firmware

When a new firmware update for the transceiver is available, download the information from the Yaesu website to update the transceiver to the latest state.

Using the transceiver for packet communications

Connecting the transceiver to a TNC (Terminal Node Controller) enables packet communications through the transceiver.

● Preparation

- TNC
- Computer
- Data cable* ... Prepare a cable suitable for the connected device.

*The following optional products are available.

- Data cable “CT-167” (optional)

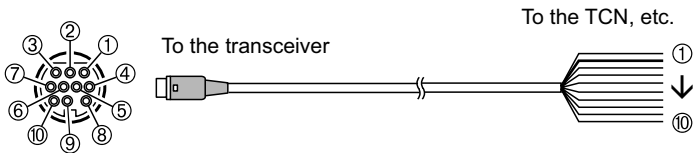

- ① PKD (packet data input)
- ② GND
- ③ PSK (PTT)
- ④ RX 9600 (9,600 bps packet data output)
- ⑤ RX 1200 (1,200 bps packet data output)
- ⑥ PK SQL (squelch control)
- ⑦ TXD (serial data output [transceiver → PC])
- ⑧ RXD (serial data input [transceiver ← PC])
- ⑨ CTS (data communication control)
- ⑩ RTS (data communication control)

- ① brown PKD (packet data input)
- ② thick black GND
- ③ red PSK (PTT)
- ④ orange RX 9600 (9,600 bps packet data output)
- ⑤ yellow RX 1200 (1,200 bps packet data output)
- ⑥ green PK SQL (squelch control)
- ⑦ blue TXD (serial data output [transceiver → PC])
- ⑧ gray RXD (serial data input [transceiver ← PC])
- ⑨ white CTS (data communication control)
- ⑩ black RTS (data communication control)

- Data cable “CT-164” (optional)

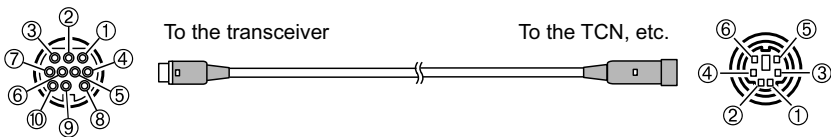

- ① PKD (packet data input)
- ② GND
- ③ PSK (PTT)
- ④ RX 9600 (9,600 bps packet data output)
- ⑤ RX 1200 (1,200 bps packet data output)
- ⑥ PK SQL (squelch control)
- ⑦ -
- ⑧ -
- ⑨ -
- ⑩ -

- ① PKD (packet data input)
- ② GND
- ③ PSK (PTT)
- ④ RX 9600 (9,600 bps packet data output)
- ⑤ RX 1200 (1,200 bps packet data output)
- ⑥ PK SQL (squelch control)

Connecting an external device

- Data cable “CT-163” (optional)

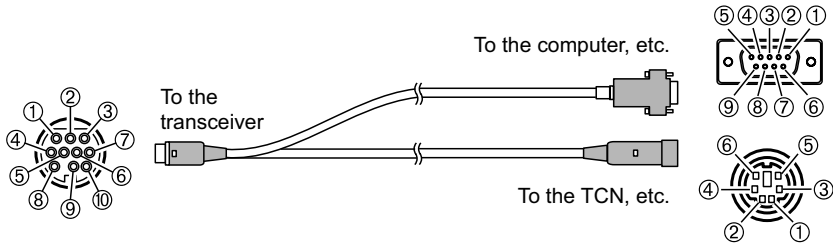

- ① PKD (packet data input)
- ② GND
- ③ PSK (PTT)
- ④ RX 9600 (9,600 bps packet data output)
- ⑤ RX 1200 (1,200 bps packet data output)
- ⑥ PK SQL (squelch control)
- ⑦ TXD (serial data output [transceiver → PC])
- ⑧ RXD (serial data input [transceiver ← PC])
- ⑨ CTS (data communication control)
- ⑩ RTS (data communication control)

Dsub 9 pin

- ① –
- ② TXD (serial data output [transceiver → PC])
- ③ RXD (serial data input [transceiver ← PC])
- ④ –
- ⑤ GND
- ⑥ –
- ⑦ CTS (data communication control)
- ⑧ RTS (data communication control)
- ⑨ –

DIN 6 pin

- ① PKD (packet data input)
- ② GND
- ③ PSK (PTT)
- ④ RX 9600 (9,600 bps packet data output)
- ⑤ RX 1200 (1,200 bps packet data output)
- ⑥ PK SQL (squelch control)

Tips

- Make sure to turn off the transceiver before connecting cables.
- For details on connecting to a TNC or computer, see the instruction manual supplied with the TNC.
- The computer may cause interference with reception.
When signals cannot be received normally, move the computer away from the transceiver and use a photo-coupler and noise filter to connect.

● Setting the packet communication operation

- 1 Turn on the transceiver.
- 2 Press and hold **DISP SETUP** for over one second.
The Setup menu appears.
- 3 Rotate the DIAL to select **[9 DATA]**, then press **DISP SETUP**.
The menu list appears.

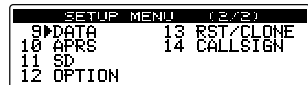

- 4 Rotate the DIAL to select [1 COM PORT SETTING], then press .

The detail settings screen appears.

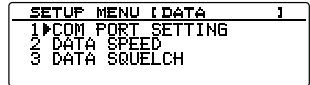

- 5 Rotate the DIAL to select [COM OUTPUT], then press .



- 6 Rotate the DIAL to select “PACKET”, then press .
“OFF” → “GPS OUT” → “PACKET” → “WAYPOINT”

Tip The default setting: OFF

- 7 Rotate the DIAL to select [COM SPEED], then press .





- 8 Rotate the DIAL to select the desired communication speed, then press .
The setting changes in the following order.

“4800 bps” → “9600 bps” → “19200 bps” → “38400 bps” → “57600 bps”

Tip The default setting: 9600 bps

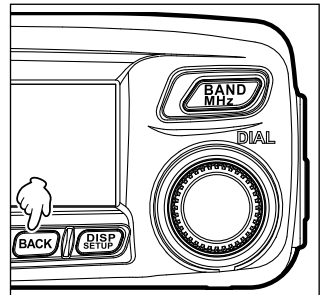
- 9 Press .





- 10 Rotate the DIAL to select [2 DATA SPEED], then press .

The detail settings screen appears.

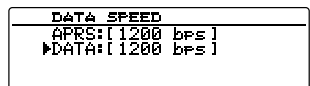

- 11 Rotate the DIAL to select [DATA], and then press .



- 12 Rotate the DIAL to select the desired packet communication speed, then press .

Rotating the DIAL changes the speed between “1200 bps” and “9600 bps”.

Tip The default setting: 1200 bps

- 13 Press .

Connecting an external device

- 14** Rotate the DIAL to select [3 DATA SQUELCH], then press .

The detail settings screen appears.

SETUP MENU I DATA	1
1 COM PORT SETTING	
2 DATA SPEED	
3 DATA SQUELCH	

- 15** Rotate the DIAL to select the desired squelch detection method for the packet communication, then press .

Select “1 TX:ON” or “2 TX:OFF”.

Tip The default setting: 1 TX:ON

DATA SQUELCH
1 TX:ON
2 TX:OFF

- 16** Press and hold  for over one second.

Returns the display to the previously viewed operating screen.

Enables the packet communication.

- 17** Using the settings in the Setup menu, select the band and frequency.

- 18** Rotate VOL.

Sets the output level to the TNC from the transceiver.

- 19** Adjust the TNC output level.

Sets the input level to the transceiver.

Caution

Transmitting a large amount of data may take a long time, causing for the transceiver to overheat.

When overheating occurs, the high temperature prevention circuit activates to lower the transmit power output. If transmission continues further, the transceiver automatically cancels transmit and returns to receive mode in order to prevent damage to the transceiver.

When the high temperature protection circuit activates, turn the power OFF or leave the transceiver in receive mode until the temperature cools.

Tip

Use the optional cooling fan SMB-201 to effectively cool down the transceiver that has heated up due to continuous transmission.

Other connectable devices

● External speaker

The optional high output, high fidelity, waterproof external speaker “MLS-200-M10” may be connected to the transceiver.

Plug the external speaker into the EXT SP jack on the rear side of the transceiver.

Tip

When an external speaker is connected to the EXT SP jack, the internal speaker does not output audio.

Caution

When connecting an external speaker other than the optional MLS-200-M10 to the EXT SP jack on the rear of the transceiver, use only a stereo type speaker plug. Sound outputs only from the L (left) side. Using a monaural speaker plug may cause a malfunction of the transceiver. When connecting a monaural speaker, use the supplied stereo to monaural adapter plug (refer to the illustration below).

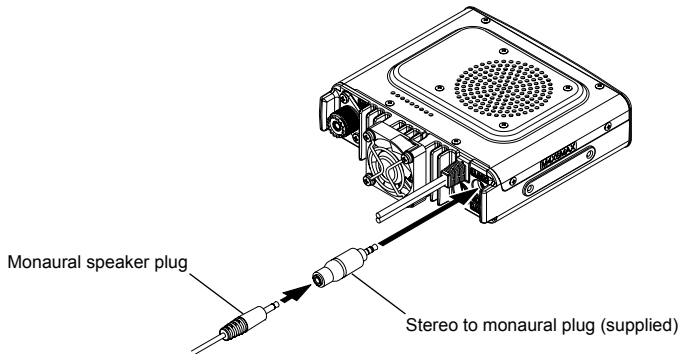

From the Setup menu, the various functions of the transceiver may be customized according to your personal preferences. The functions are categorized into: display, transmission/reception, memory, device configuration, etc., in the menu. It is easy to select the item to adjust from each menu list, and then input or select the desired setting.

Setup menu basic operations

- 1 Press and hold **DISP SETUP** for over one second.
The Setup menu appears.
- 2 Rotate the DIAL to select the desired menu item, then select **DISP SETUP**.
The menu list appears.
- 3 Rotate the DIAL to select the item to be set, then press **DISP SETUP**.
- 4 Rotate the DIAL to change the setting value.

SETUP MENU (MENU)			
1	DISPLAY	5	SCAN
2	TX/RX	6	GM
3	MEMORY	7	WIRES-X
4	SIGNALING	8	CONFIG

SETUP MENU (DISPLAY) 1	
1	SUB DISPLAY SELECT
2	LCD BRIGHTNESS
3	LCD CONTRAST
4	GPS INFORMATION

SUB DISPLAY SELECT	
1	SUB BAND
2	TIME
3	VOLT

- 5 Press and hold **DISP SETUP** for over one second, or press **[PTT]**.

The selected value is set, and the display returns to the previous operating screen.

- Tips**
- Pressing the **GM** key can also confirm the set value and return the screen to the previously viewed screen.
 - To set other items from the same menu list, press **BACK** to confirm the setting value and return the display to the menu list screen.
 - Pressing **BACK** on each screen returns the display to previously viewed screen.

Tip

When a selected Setup Menu item is displayed, the previously set value will be shown on the screen. A beep sounds when the default value is selected while setting the new setting value.

Setup-menu listing

Menu / Item	Description	Selectable options (Options in bold are the default settings)
1 DISPLAY		
1	SUB DISPLAY SELECT	Sets the sub-display content SUB BAND / TIME / VOLT
2	LCD BRIGHTNESS	Sets the screen brightness MIN / 2 / 3 / 4 / 5 / 6 / MAX
3	LCD CONTRAST	Sets the screen contrast -3 / -2 / -1 / 0 / +1 / +2 / +3
4	GPS INFORMATION	Switches the GPS information LOCATION / FREQUENCY
2 TX/RX		
1	ANALOG MODE SELECT	Sets analog mode AUTO / MANUAL (FM) / MANUAL (AM)
2	MIC GAIN	Sets the microphone sensitivity MIN / LOW / NORMAL / HIGH / MAX
3	AMS TX MODE	Sets the transmission mode AUTO / TX MANUAL / TX FM FIXED / TX DN FIXED / TX VW FIXED
4	DIGITAL SQL TYPE	Sets the squelch type in digital mode OFF / CODE / BREAK
5	DIGITAL SQL CODE	Sets the squelch code in digital mode CODE: 001 to 126
6	DIGITAL POPUP TIME	Sets the information pop-up time OFF / 2 sec / 4 sec / 6 sec / 8 sec / 10 sec / 20 sec / 30 sec / 60 sec / CONTINUE
7	LOCATION SERVICE	Sets your location information display in digital mode ON / OFF For details, refer to the GM Function Instruction Manual.
8	STANDBY BEEP	Activates/deactivates the standby beep ON / OFF
9	HALF DEVIATION	Activates/deactivates the half deviation ON / OFF
3 MEMORY		
1	ALPHA TAG SIZE	Sets the memory channel tag display size SMALL / LARGE
2	MEMORY SCAN TYPE	Sets the memory scan method ALL MEMORY / SELECT MEMORY
4 SIGNALING		
1	TONE SQL FREQ	Sets the tone frequency 67.0 Hz to 254.1 Hz 100.0 Hz
2	DCS CODE	Sets the DCS code 023 to 754
3	AUTO DIALER	Activates/deactivates the DTMF code automatic transmission ON / OFF
4	SQL TYPE	Sets the squelch type OFF / TONE ENC / TONE SQL / REV TONE / DCS / PR FREQ / PAGER / DCS ENC* / TONE DCS* / DCS TSQ* *Displays only when [4 SIGNALING] → [9 SQL EXPANSION] is set to "ON".
5	DTMF MEMORY	Registers the DTMF code 1 to 9, 16 characters for each
6	PAGER CODE	Sets the individual pager code RX CODE 1: 01 to 50 05 RX CODE 2: 01 to 50 47 TX CODE 1: 01 to 50 05 TX CODE 2: 01 to 50 47

Setup-menu listing

Menu / Item		Description	Selectable options (Options in bold are the default settings)
7	PRG REV TONE	Set the idle line squelch	300 Hz to 3000 Hz 1500 Hz
8	BELL RINGER	Sets the number of successive bell rings	OFF / 1 time / 3 times / 5 times / 8 times / CONTINUOUS
9	SQL EXPANSION	Sets the squelch type separately for transmission and reception	ON / OFF
10	WX ALERT (USA Version Only)	Weather alert operation setting	ON / OFF
5 SCAN			
1	DUAL WATCH STOP	Sets the signal reception method	AUTO / HOLD
2	SCAN DIRECTION	Sets the scanning direction when scanning starts	UP / DOWN
3	SCAN RESUME	Sets the operation when scanning stops	BUSY / HOLD / 1 sec / 3 sec / 5 sec
4	DUAL WATCH MODE	Sets the reception time while processing the dual reception function	0.3 sec to 10 sec 5.0 sec
6 GM			
1	RANGE RINGER	Activates/deactivates the alert sound when detecting stations within communication range	OFF / ON
2	MESSAGE POPUP	Activates/deactivates the pop-up message display	OFF / ON
3	RADIO ID	Displays the transceiver IDs	- (uneditable)
* For details of the functions, refer to the GM Function Instruction Manual.			
7 WIRES-X			
1	RPT/WIRES FREQ FREQ	Sets the operating frequencies for repeater and WIRES-X operations. Registers the preset frequency.	MANUAL / PRESET Depends on the transceiver version
* For details of the functions, refer to the WIRES-X Instruction Manual.			
8 CONFIG			
1	DATE & TIME ADJUST	Sets the date and time using the internal clock	month/day/year, hour : minute
2	TIME FORMAT	Sets the time display format	24 hour / 12 hour
3	TIME ZONE	Sets the time zone	UTC ±14h (0.5 h interval) UTC ±0:00
4	AUTO REPEATER SHIFT	Activates/deactivates the automatic repeater shift function	OFF / ON
5	REPEATER SHIFT	Sets the repeater shift direction	SIMPLEX / - REPEATER / + REPEATER (Differs depending on frequency)
6	REPEATER SHIFT FREQ	Sets the repeater shift width	0.000 to 99.950MHz (Differs depending on frequency)

Menu / Item		Description	Selectable options (Options in bold are the default settings)
7	FM AM STEP	Sets the channel step	AUTO / 5.00 KHz / 6.25 KHz / (8.33 KHz) / 10.00 KHz / 12.50 KHz / 15.00 KHz / 20.00 KHz / 25.00 KHz / 50.00 KHz / 100.00 KHz
8	BEEP	Sets the beep function	OFF / LOW / HIGH
9	CLOCK TYPE	Sets the clock shift	A / B
10	MIC PROGRAM KEY	Sets the microphone P buttons	OFF / SQL TYPE / SCAN / HOME / DCS CODE / TONE FREQ / RPT SHIFT / REVERSE / TX POWER / SQL OFF / T-CALL / VOICE* / D_X / WX / S-LIST / MSG / REPLY / M-EDIT *Displays when the optional FVS-2 is attached. P1KEY: SQL OFF P2KEY: HOME P3KEY: D_X P4KEY: TX POWER
11	RX COVERAGE	Sets the reception range expansion setting to on/off	NORMAL / WIDE
12	UNIT	Sets the unit used for the display	METRIC / INCH (Depends on the transceiver version)
13	APO	Sets the APO action time	OFF / 0.5 hour to 12.0 hour
14	TOT	Sets the time-out timer	OFF / 1 min / 2 min / 3 min / 5 min / 10 min / 20 min / 30 min
15	Bluetooth PAIRING	Sets the PIN code and starts pairing	0000 to 9999 6111
16	GPS DATUM	Selects the GPS function positioning	WGS-84 / TOKYO MEAN
17	GPS LOG	Sets the time interval to log the GPS location information	OFF / 1 sec / 2 sec / 5sec / 10 sec / 30 sec / 60 sec
9 DATA			
1	COM PORT SETTING	Sets the COM port	COM SPEED: 4800bps / 9600bps / 19200bps / 38400bps / 57600bps COM OUTPUT: OFF / GPS OUT / PACKET / WAYPOINT WP FORMAT: NMEA6 / NMEA7 / NMEA8 / NMEA9 WP FILTER: ALL / MOBILE / FREQUENCY / OBJECT/ITEM / DIGIPEATER / VoIP / WEATHER / YAESU / CALL RINGER / RNG RINGER
2	DATA SPEED	Sets the APRS/DATA communication baud rate	APRS: 1200 bps / 9600 bps DATA: 1200 bps / 9600 bps
3	DATA SQUELCH	Sets the squelch detection to on/off	TX: ON / TX: OFF

Setup-menu listing

Menu / Item	Description	Selectable options (Options in bold are the default settings)
10 APRS		
1	APRS COMPASS	Sets the APRS compass display NORTH UP / HEADING UP
2	APRS DISTINATION	Displays the model code APY*** (cannot edit)
3	APRS FILTER	Sets the filter function Mic-E: ON / OFF POSITION: ON / OFF WEATHER: ON / OFF OBJECT: ON / OFF ITEM: ON / OFF STATUS: ON / OFF OTHER: ON / OFF RANGE LIMIT: 1 to 3000 / OFF ALT.NET: ON / OFF
4	APRS MESSAGE TEXT	Inputs the predetermined routine message 1 to 8 ch
5	APRS MODEM	Activates/deactivates the APRS function OFF / ON
6	APRS MUTE	Activates/deactivates the AF mute function when using the APRS function OFF / ON
7	APRS POP-UP	Sets the duration time for displaying the pop-up beacons and messages BEACON: OFF / 3 sec / 5 sec / 10 sec / HOLD MESSAGE: OFF / 3 sec / 5 sec / 10 sec / HOLD MYPACKET: OFF / ON
8	APRS RINGER	Sets the audio alert when receiving beacons TX BEACON: ON / OFF TX MESSAGE: ON / OFF RX BEACON: ON / OFF RX MESSAGE: ON / OFF MY PACKET: ON / OFF CALL RINGER: ON / OFF RANGE RINGER: 1 to 100 / OFF MSG VOICE: ON / OFF
9	APRS RINGER (CALL)	Sets the call sign for CALL RINGER 1 to 8 stations (*****)
10	APRS TX DELAY	Sets the data transmission delay time 100 ms / 150 ms / 200 ms / 250 ms / 300 ms / 400 ms / 500 ms / 750 ms / 1000 ms
11	APRS UNITS	Sets the unit used for the APRS display POSITION: dd°mm'mm" / dd°mm.mm' DISTANCE: km / mile SPEED: km/h / mph / knot ALTITUDE: m / ft BARO: hPa / mb / mmHg / inHg TEMP: °C / °F RAIN: mm / inch WIND: m/s / mph / knot
12	BEACON INFO SELECT	Sets the beacon information to transmit AMBIGUITY: OFF / 1 to 4 digit SPEED/COURSE: ON / OFF ALTITUDE: ON / OFF

Menu / Item	Description	Selectable options (Options in bold are the default settings)
13 BEACON STATUS TEXT	Sets the status text input	SELECT: TEXT 1 to 5 / OFF TX RATE: 1/1 to 1/8 / 1/2 (FREQ) to 1/8 (FREQ) TEXT 1 to 5: NONE / FREQUENCY / FREQ & SQL & SHIFT
14 BEACON TX	Switches the beacon transmission between automatic transmission and manual transmission	AUTO: OFF / ON / SMART INTERVAL: 30sec to 60min 5min PROPORTIONAL: ON / OFF DECAY: ON / OFF LOW SPEED: 1 to 99 3 RATE LIMIT: 5sec to 180sec 30sec
15 DIGI PATH SELECT	Sets the digital repeater route	OFF / WIDE1-1 / WIDE1-1,WIDE2-1
16 MY CALLSIGN (APRS)	Sets your call sign	*****-**
17 MESSAGE GROUP	Sets the group filter for received messages	GROUP 1: ALL***** GROUP 2: CQ***** GROUP 3: QST***** GROUP 4: YAESU**** GROUP 5: - GROUP 6: - BULLETIN 1: BLN?***** BULLETIN 2: BLN? BULLETIN 3: BLN?
18 MESSAGE REPLY	Sets the automatic response for received messages	REPLY: OFF / ON CALLSIGN: *****-** REPLY TEXT: -
19 MY POSITION SET	Sets your location	GPS / MANUAL
20 MY POSITION	Sets your location manually	LAT:[N *O** * (****)] LON:[E *O** * (****)]
21 MY SYMBOL	Sets your station symbol	ICON 1: [/>] Car ICON2: [/R] REC.Vehicle ICON3: [/-] House QTH (VHF) USER: [YY] Yaesu Radios
22 POSITION COMMENT	Sets the location comments	Off Duty / En Route / In Service / Returning / Committed / Special / Priority / Custom 0 to 6 / Emergency!
23 SmartBeaconing	Sets the smart beaconing	STATUS: OFF / TYPE1 / TYPE2 / TYPE3 LOW SPEED: 2 to 30 5 HIGH SPEED: 3 to 90 70 SLOW RATE: 1 to 100min 30min FAST RATE: 10 to 180sec 120sec TURN ANGLE: 5 to 90° 28° TURN SLOPE: 1 to 255 26 TURN TIME: 5 to 180sec 30sec
24 SORT FILTER	Sets the sort and filter functions	SORT: TIME / CALLSIGN / DISTANCE FILTER: ALL / MOBILE / FREQUENCY / OBJECT/ITEM / DIGIPEATER / VoIP / WEATHER / YAESU / OTHER PACKET / CALL RINGER / RANGE RINGER / 1200 bps / 9600 bps

Setup-menu listing

Menu / Item		Description	Selectable options (Options in bold are the default settings)
25	VOICE ALERT	Sets the voice alert function	V ALERT: NORMAL / TONE SQL / DCS / RX-TSQL / RX-DCS TONE SQL: 67.0Hz to 254.1Hz 100.0Hz DCS: 023 to 754 023
* For details of the functions, refer to the APRS Instruction Manual.			
11 SD			
1	BACKUP	Copies information to/from the microSD memory card	Write to SD / Read from SD
2	FORMAT	Initializes the microSD memory card	-
12 OPTION			
1	Bluetooth	Sets the Bluetooth headset	AUDIO: AUTO / FIX BATTERY: NORMAL / SAVE PTT MODE: MOMENTARY / TOGGLE VOX: ON / OFF GAIN: HIGH / LOW
2	VOICE MEMORY	Sets the voice memory function	PLAY/REC: FREE 5min / LAST 30sec ANNOUNCE: AUTO / MANUAL LANGUAGE: JAPANESE / ENGLISH VOLUME: HIGH / MID / LOW
13 RST/CLONE			
1	FACTORY RESET	Restores all settings to the default state	-
2	PRESET	Presets the desired setting value	-
3	RECALL PRESET	Recalls the preset information	-
4	MEMORY CH RESET	Clears the information registered to the memory channels	-
5	MEMORY CH SORT	Sorts the memory channels you use	-
6	APRS RESET	Restores all the APRS settings to the default state	-
7	CLONE	Copies all the saved data	This radio → other / Other → This radio
8	SOFTWARE VERSION	Displays the transceiver software version	MAIN CPU Ver: *.* / PANEL CPU Ver: *.* / DSP CPU Ver: *.*
14 CALLSIGN			
1	MY CALLSIGN (DIGITAL)	Sets your station call sign	*****

Setup menu operations: 1 DISPLAY

Setting up the screen display (1 SUB DISPLAY SELECT)

Choose the information to be shown on the sub-display.

- 1 Press and hold **DISP SETUP** for over one second.
The Setup menu appears.

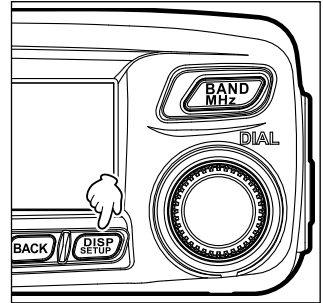

- 2 Rotate the DIAL to select **[1 DISPLAY]**, then press **DISP SETUP**.

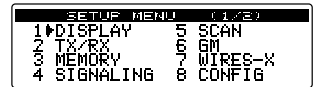

- 3 Rotate the DIAL to select **[1 SUB DISPLAY SELECT]**, then press **DISP SETUP**.

The sub-display setting screen appears.



- 4 Rotate the DIAL to select the information to display on the sub-display.

1 SUB BAND: Displays the sub-band operating information.

2 TIME: Displays the time.

3 VDD: Displays the voltage.

Tip The default setting: 1 SUB BAND



- 5 Press and hold **DISP SETUP** for over one second.

Sets the information displayed on the sub-display and returns the display to the previous operating screen.

Setting the display brightness (2 LCD BRIGHTNESS)

You can adjust the display brightness.

For details, see "Adjusting the display brightness" on page 48.

Setting the display contrast (3 LCD CONTRAST)

You can adjust the display contrast.

For details, see "Adjusting the display brightness" on page 48.

Switching the GPS information (4 GPS INFORMATION)

You can set the information to display on the GPS INFO screen.

- 1 Press and hold  for over one second.

The Setup menu appears.

- 2 Rotate the DIAL to select [1 DISPLAY], then press



SETUP MENU (1/2)		
1	DISPLAY	5 SCAN
2	TR/RX	6 GM
3	MEMORY	7 WIRES-X
4	SIGNALING	8 CONFIG

- 3 Rotate the DIAL to select [4 GPS INFORMATION], then press .

SETUP MENU DISPLAY 1	
1	SUB DISPLAY SELECT
2	LCD BRIGHTNESS
3	LCD CONTRAST
4	GPS INFORMATION

- 4 Rotate the DIAL to select the GPS information to be displayed.

1 LOCATION: Displays your location information.

2 FREQUENCY: Displays the frequency.

Tip The default setting: 1 LOCATION

GPS INFORMATION	
1	LOCATION
2	FREQUENCY

- 5 Press and hold  for over one second.

Sets the display information and returns the display to the previously viewed screen.

Setup menu operations: 2 TX/RX

Setting the modulation mode (1 ANALOG MODE SELECT)

You can select the modulation mode in analog mode.

For details, see “Switching the modulation mode” on page 40.

Setting the microphone sensitivity (2 MIC GAIN)

You can set the microphone sensitivity (microphone gain).

For details, see “Adjusting the microphone sensitivity” on page 42.

Setting the transmission mode when using the AMS function (3 AMS TX MODE)

You can select the transmission mode when using the AMS function.

- 1 Press and hold **DISP SETUP** for over one second.
The Setup menu appears.

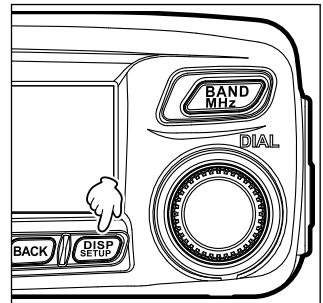

- 2 Rotate the DIAL to select **[2 TX/RX]**, then press **DISP SETUP**.
- 3 Rotate the DIAL to select **[3 AMS TX MODE]**, then press **DISP SETUP**.
- 4 Rotate the DIAL to select the desired transmission mode.

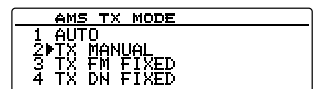
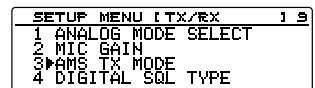
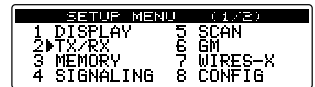

1 AUTO:

Automatically selects one of the 4 communication modes according to the received signal.

2 TX MANUAL:

Automatically selects one of the 4 communication modes according to the received signal. Briefly pressing [PTT] on the microphone switches between digital mode and analog mode.

3 TX FM FIXED:

Automatically selects one of the 4 communication modes according to the received signal. Always switches to FM mode for transmission.

4 TX DN FIXED:

Automatically selects one of the 4 communication modes according to the received signal. Always switches to DN mode for transmission.

5 TX VW FIXED:

Automatically selects one of the 4 communication modes according to the received signal. Always switches to VW mode for transmission.

Tips

- The default setting: 2 TX MANUAL
- When "■" blinks: 2 TX MANUAL
- When "○○" blinks: 3 TX FM FIXED / 4 TX DN FIXED / 5 TX VW FIXED
- When "○○" lights up: 1 AUTO
- *The "○○" part differs depending on the received signal.

5 Press and hold **DISP SETUP** for over one second.

Sets the transmission mode when using the AMS function and returns the display to the previously viewed screen.

Setting the squelch type in digital mode (4 DIGITAL SQL TYPE)

You can set the squelch type in digital mode.

1 Press and hold **DISP SETUP** over one second.

The Setup menu appears.

2 Rotate the DIAL to select [2 TX/RX], then press



SETUP MENU (TX/RX)	
1 DISPLAY	5 SCAN
2 TX/RX	6 GM
3 MEMORY	7 WIRES-X
4 SIGNALING	8 CONFIG

3 Rotate the DIAL to select [4 DIGITAL SQL TYPE],

then press **DISP SETUP**.

SETUP MENU I TX/RX		1 9
1 ANALOG MODE SELECT		
2 MIC GAIN		
3 AMS TX MODE		
4 DIGITAL SQL TYPE		

- 4 Rotate the DIAL to select the desired squelch type.
 - 1 OFF: Outputs sound whenever receiving digital signals from Yaesu transceivers.
 - 2 CODE: Outputs sound only when receiving signals containing the SQL CODE corresponding to the code you set.
 - 3 BREAK: Regardless of the SQL CODE setting, outputs sound when the partner station transmits with the BREAK setting activated.

DIGITAL SQL TYPE	
1	OFF
2	CODE
3	BREAK

Tip The default setting: 1 OFF

- 5 Press and hold **DISP SETUP** for over one second.
Sets the squelch type and returns the display to the previously viewed screen.

Setting the digital mode squelch code (5 DIGITAL SQL CODE)

You can set the squelch code in digital mode.

- 1 Press and hold **DISP SETUP** for over one second.
The Setup menu appears.
- 2 Rotate the DIAL to select **[2 TX/RX]**, then press **DISP SETUP**.
- 3 Rotate the DIAL to select **[5 DIGITAL SQL CODE]**, then press **DISP SETUP**.
- 4 Rotate the DIAL to select the desired code.

Tips

 - The code can be selected from 001 to 126.
 - The default setting: 001
- 5 Press and hold **DISP SETUP** for over one second.
Sets the squelch code and returns the display to the previously viewed screen.

SETUP MENU [TX/RX]	
1	DISPLAY
2	TX/RX
3	MEMORY
4	SIGNALING
5	SCAN
6	SQL
7	WIRE-X
8	CONFIG

SETUP MENU [TX/RX]	
5	DIGITAL SQL CODE
6	DIGITAL POPUP TIME
7	LOCATION SERVICE
8	STANDBY BEEP

DIGITAL SQL CODE	
1	001
	002
	003
	004

Setting the time to display the partner station information in a pop-up window (6 DIGITAL POPUP TIME)

You can set the time to display the partner station information such as the call sign.

- 1 Press and hold **DISP SETUP** for over one second.
The Setup menu appears.
- 2 Rotate the DIAL to select **[2 TX/RX]**, then press **DISP SETUP**.

SETUP MENU (1/2)			
1	DISPLAY	5	SCAN
2	TX/RX	6	GM
3	MEMORY	7	WIRES-X
4	SIGNALING	8	CONFIG

- 3 Rotate the DIAL to select **[6 DIGITAL POPUP TIME]**, then press **DISP SETUP**.

SETUP MENU TX/RX 1/2			
5	DIGITAL POPUP TIME		
6	LOCATION SERVICE		
8	STANDBY BEEP		
9	HALF DEVIATION		

- 4 Rotate the DIAL to select the time to display the pop-up window.

“1 OFF”, “2 2 sec”, “3 4 sec”, “4 6 sec”, “5 8 sec”,
“6 10 sec”, “7 20 sec”, “8 30 sec”, “9 60 sec”,
“10 CONTINUE”

DIGITAL POPUP TIME	
5	8 sec
6	10 sec
7	20 sec
8	30 sec

Tip The default setting: 6 10 sec

- 5 Press and hold **DISP SETUP** for over one second.
Sets the time and returns the display to the previously viewed screen.

Setting your location information display (7 LOCATION SERVICE)

For details of the functions, refer to the GM Function Instruction Manual (download from Yaesu website).

Sounding a beep when a partner station ends a transmission (8 STANDBY BEEP)

In digital communication, the transceiver can inform you that the partner station completes a transmission by emitting a beep.

- 1 Press and hold **(DISP SETUP)** for over one second.

The Setup menu appears.

- 2 Rotate the DIAL to select **[2 TX/RX]**, then press **(DISP SETUP)**.

SETUP MENU (TX/RX)	
1 DISPLAY	5 SCAN
2 TX/RX	6 GM
3 MEMORY	7 WIRES-X
4 SIGNALING	8 CONFIG

- 3 Rotate the DIAL to select **[8 STANDBY BEEP]**, then press **(DISP SETUP)**.

SETUP MENU (TX/RX)	
6 DIGITAL POPUP TIME	
7 LOCATION SERVICE	
8 STANDBY BEEP	
9 HALF DEVIATION	

- 4 Rotate the DIAL to switch the setting between ON and OFF.

1 ON: Emits a beep when the partner station completes a transmission.

2 OFF: Does not emit a beep when the partner station completes a transmission.

Tip The default setting: 1 ON



- 5 Press and hold **(DISP SETUP)** for over one second.
Returns the display to the previously viewed screen.

STANDBY BEEP	
1 ON	
2 OFF	

Setup menu operations: 2 TX/RX

Using the half deviation function (9 HALF DEVIATION)

You can lower the degree of modulation by half.

- 1 Press and hold  for over one second.
The Setup menu appears.
- 2 Rotate the DIAL to select [2 TX/RX], then press .

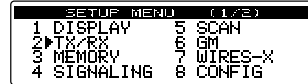

- 3 Rotate the DIAL to select [9 HALF DEVIATION], then press .

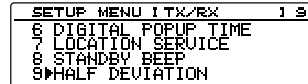

- 4 Rotate the DIAL to select the desired setting.
1 ON: Reduces the FM modulation to half.
2 OFF: Uses the normal FM modulation

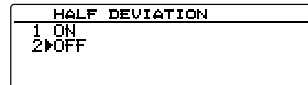

Tip The default setting: 2 OFF

- 5 Press and hold  for over one second.
Returns the display to the previously viewed screen.

Setup menu operations: 3 MEMORY

Setting the memory tag display (1 ALPHA TAG SIZE)

You can change the displays of the name and frequency registered to each channel. For details, see “Displaying the memory tag” on page 58.

Setting the memory scan method (2 MEMORY SCAN TYPE)

You can scan either all the memory channels or only the specified memory channels. For details, see “Selecting the scanning method” on page 65.

Setup menu operations: 4 SIGNALING

Setting the tone frequency (1 TONE SQL FREQ)

The tone frequency may be changed.

For details, see “Selecting the tone frequency” on page 81.

Setting the DCS code (2 DCS CODE)

You can set the DCS code.

For details, see “Selecting the DCS code” on page 84.

Setting the DTMF code transmission method (3 AUTO DIALER)

You can set method (Auto or Manual) to transmit the registered DTMF code.

For details, see “Transmitting the registered DTMF code” on page 92.

Setting the squelch type (4 SQL TYPE)

Select the squelch type.

For details, see “Communicating with specific stations” on page 81.

Registering the DTMF code (5 DTMF MEMORY)

The maximum of 16-digit DTMF codes can be registered for telephone numbers to make a call through the public telephone line from a phone patch.

For details, see “Registering the DTMF code” on page 91.

Calling only the specific stations (6 PAGER CODE)

Using the new pager code permits calls to specific stations only.

For details, see “Using the new pager function” on page 86.

Notification of calls from partner stations (8 BELL RINGER)

The beep may be set to alert you of a call from partner stations.

For details, see “Notification of incoming calls from partner stations using the bell function” on page 89.

Setting the squelch type separately for transmission and reception (9 SQL EXPANSION)

You can set the squelch type separately for transmission and reception.

- Press and hold **DISP SETUP** for over one second.
The Setup menu appears.
- Rotate the DIAL to select **[4 SIGNALING]**, then press **DISP SETUP**.
- Rotate the DIAL to select **[9 SQL EXPANSION]**, then press **DISP SETUP**.
- Rotate the DIAL to select the desired setting.
 - ON: Uses different squelch types for transmission and reception. For details, see “Other squelch functions” on page 90.
 - OFF: Uses the same squelch for transmission and reception.

SETUP MENU (1/2)	
1 DISPLAY	5 SCAN
2 TX/RX	6 GM
3 MEMORY	7 WIRES-X
4 SIGNALING	8 CONFIG

SETUP MENU SIGNALING 3	
6 PAGER CODE	
7 PRG REV TONE	
8 BELL RINGER	
9 SQL EXPANSION	

SQL EXPANSION	
1 ON	
2 OFF	

Tip The default setting: 2 OFF

- Press and hold **DISP SETUP** for over one second.
Sets the squelch type for transmission and reception and returns the display to the previously viewed screen.

Setting the weather alert operation (USA Version Only) (10 WX ALERT)

The reception of the weather alert can be disabled.

- Press and hold **DISP SETUP** for over one second.
The Setup menu appears.
- Rotate the DIAL to select **[4 SIGNALING]**, then press **DISP SETUP**.
- Rotate the DIAL to select **[10 WX ALERT]**, then press **DISP SETUP**.
- Rotate the DIAL to select the desired setting.
 - ON: The weather alert will be received.
 - OFF: The weather alert will not be received.

Tip The default setting: 2 OFF

- Press and hold **DISP SETUP** for over one second.
Sets the weather alert operation and returns the display to the previously viewed screen.

Setup menu operations: 5 SCAN

Setting the signal reception method (1 DUAL WATCH STOP)

While operating in the DW (Dual Watch) mode, the receive operation after detecting signals on the home channel may be changed.

For details, see “Setting the dual receive restart setting” on page 71.



Setting the scanning direction (2 SCAN DIRECTION)

In the Setup menu, from [8 CONFIG] → [10 MIC PROGRAM KEY], assign [SCAN] to one of the [P1] to [P4] keys on the microphone to set whether to scan in the higher direction or lower direction of the frequencies or memory channels when scanning on that key.

For details on how to assign the function to [P1] to [P4], see “Setting the program keys on the microphone (10 MIC PROGRAM KEY)” on page 138.

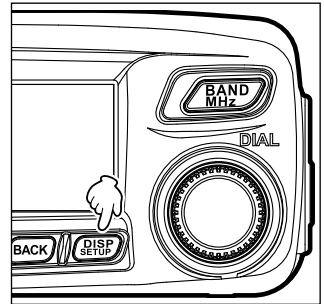
- 1 Press and hold  for over 1 second.
The Setup menu appears.



- 2 Rotate the DIAL to select [5 SCAN], then press .
- 3 Rotate the DIAL to select [2 SCAN DIRECTION], then press .
- 4 Rotate the DIAL to set the desired setting.
 - 1 UP: Scans in the higher direction of the frequencies or memory channels.
 - 2 DOWN: Scans in the lower direction of the frequencies or memory channels.

Tip The default setting: 1 UP

- 5 Press and hold  for over 1 second.
Sets the scanning direction and returns the screen to the previously viewed screen.

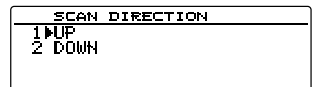
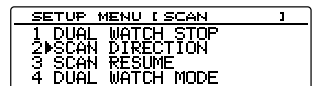
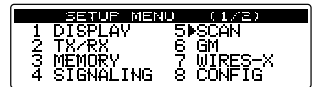

Setup menu operations: 5 SCAN

Selecting the receiver operation performed after scanning stops (3 SCAN RESUME)

You can select the receiver operation to be performed after the scanning stops. For details, see “Selecting the receiver operation performed after scanning stops” on page 63.

Setting the channel signal reception time when using the dual reception function (4 DUAL WATCH MODE)

Set the time to check the HOME channel when using the dual reception function. For details, see “Setting the channel signal reception time when using the dual reception function” on page 71.

Setup menu operations: 6 GM

The GM (group monitor) function enables the transceiver to automatically check whether the members on the same frequency are within communication range.

For details, refer to the separate GM Function Instruction Manual (download from Yaesu website).

Setup menu operations: 7 WIRES-X

The WIRES-X is a communication system to broaden the amateur radio communication linking worldwide using the Internet.

For details, refer to the separate WIRES-X Instruction Manual (download from Yaesu website).

Setup menu operations: 8 CONFIG

Setting the date and time (1 DATE & TIME ADJUST)

Set the date and time of the internal clock.

For details, see “Adjusting the date and time” on page 46.

Setting the time display format (2 TIME FORMAT)

Select the internal clock time display: 24 hour display or 12 hour display.

- 1 Press and hold **DISP SETUP** for over one second.
The Setup menu appears.

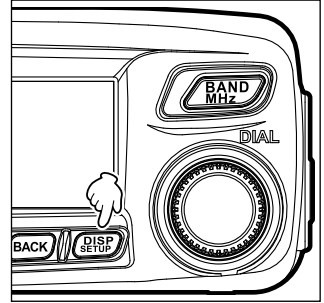

- 2 Rotate the DIAL to select **[8 CONFIG]**, then press **DISP SETUP**.

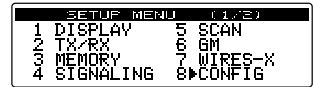

- 3 Rotate the DIAL to select **[2 TIME FORMAT]**, then press **DISP SETUP**.

Displays the time display setting screen.

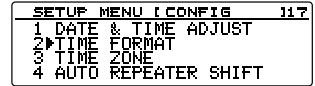

- 4 Rotate the DIAL to select “24 hour” or “12 hour”.

Tip The default setting: 24 hour

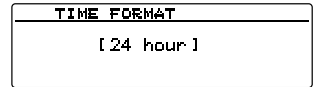

- 5 Press and hold **DISP SETUP** for over one second.

Set the time displayed on the screen and returns the display to the previously viewed screen.

Setting the time zone (3 TIME ZONE)

The internal clock can be synchronized with the Coordinated Universal Time via GPS. The time zone can be set at 0.5 hour increments within the range of ± 14 hours.

- 1 Press and hold  for over one second.

The Setup menu appears.

- 2 Rotate the DIAL to select [8 CONFIG], then press .

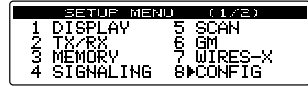

- 3 Rotate the DIAL to select [3 TIME ZONE], then press .

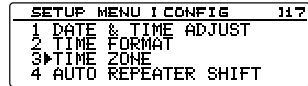

- 4 Rotate the DIAL to select the time zone.

The time zone can be set at 0.5 hour increments within the range of ± 14 hours.

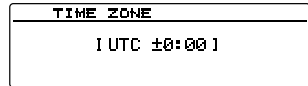

Tip The default setting: UTC $\pm 0:00$

- 5 Press and hold  for over one second.

Sets the time zone and returns the display to the previously viewed screen.

Using the auto repeater shift function (4 AUTO REPEATER SHIFT)

When communicating using a repeater channel, the repeater offset frequency may be automatically set just by tuning the VFO to the repeater frequency. The automatic repeater shift function may be changed between ON and OFF.

- 1 Press and hold  for over one second.

The Setup menu appears.

- 2 Rotate the DIAL to select [8 CONFIG], then press .

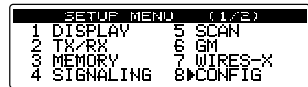

- 3 Rotate the DIAL to select [4 AUTO REPEATER SHIFT], then press .

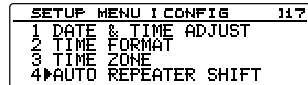

- 4 Rotate the DIAL to select the desired setting.

1 ON: Activates the auto repeater shift function.

2 OFF: Deactivates the auto repeater shift function.

Tip The default setting: 1 ON





- 5 Press and hold  for over one second.

Applies the auto repeater shift function setting and returns the display to the previously viewed screen.

Setting the repeater shift direction (5 REPEATER SHIFT)

You can set the repeater shift direction.

- 1 Press and hold  for over one second.
The Setup menu appears.
- 2 Rotate the DIAL to select [8 CONFIG], then press .
- 3 Rotate the DIAL to select [5 REPEATER SHIFT], then press .
- 4 Rotate the DIAL to select the shift direction.
 - 1 SIMPLEX: Does not shift.
 - 2 - REPEATER: Shifts in the lower frequency direction.
 - 3 + REPEATER: Shifts in the higher frequency direction.

Tip The default setting: Differs depending on frequency

- 5 Press and hold  for over one second.
Sets the repeater shift direction and returns the display to the previously viewed screen.

```

SETUP MENU (1/2)
1 DISPLAY 5 SCAN
2 TX/RX 6 GM
3 MEMORY 7 WIRES-X
4 SIGNALING 8 CONFIG
  
```

```



SETUP MENU [CONFIG 117
5 REPEATER SHIFT
6 REPEATER SHIFT FREQ
7 FM AM STEP
8 BEEP
  
```

```

REPEATER SHIFT
1 SIMPLEX
2 - REPEATER
3 + REPEATER
  
```

Setting the repeater shift width (6 REPEATER SHIFT FREQ)

You can set the repeater shift width.

- 1 Press and hold  for over one second.
The Setup menu appears.
- 2 Rotate the DIAL to select [8 CONFIG], then press .
- 3 Rotate the DIAL to select [6 REPEATER SHIFT FREQ], then press .
- 4 Rotate the DIAL to select the desired shift width.
The shift width can be set at 0.05MHz increments from 0.000MHz to 99.950MHz.

Tip The default setting: Differs depending on frequency

- 5 Press and hold  for over one second.
Sets the repeater shift width and returns the display to the previously viewed screen.

```

SETUP MENU (1/2)
1 DISPLAY 5 SCAN
2 TX/RX 6 GM
3 MEMORY 7 WIRES-X
4 SIGNALING 8 CONFIG
  
```

```

SETUP MENU [CONFIG 117
6 REPEATER SHIFT FREQ
7 FM AM STEP
8 BEEP
9 CLOCK TYPE
  
```

```

REPEATER SHIFT FREQ MHz
[ 0.000MHz ]
  
```

Setting the frequency step (7 FM AM STEP)

Using the knobs (DIAL/VOL) and keys, you can change the frequency step. For details, see “Changing the frequency steps” on page 37.

Setting the beep volume (8 BEEP)

You can change the volume of the operation beep sound. For details, see “Changing the beep volume” on page 45.

Setting the microcomputer clock shift (9 CLOCK TYPE)

You can set the transceiver microcomputer clock shift to change an internal spurious signal that may be interfering with a particular receiver frequency. Select “A” for the normal operation.

- 1 Press and hold  for over one second.

The Setup menu appears.

- 2 Rotate the DIAL to select [8 CONFIG], then press .

SETUP MENU 7/123	
1 DISPLAY	5 SCAN
2 TX/RX	6 GM
3 MEMORY	7 WIRES-X
4 SIGNALING	8 CONFIG

- 3 Rotate the DIAL to select [9 CLOCK TYPE], then press .

SETUP MENU 1 CONFIG 117	
9 CLOCK TYPE	
10 MIC PROGRAM KEY	
11 RX COVERAGE	
12 UNIT	

- 4 Rotate the DIAL to select [1 A] or [2 B].

1 A: Automatically switches the clock shift operation between ON and OFF.

2 B: Always activates the clock shift operation.

Tip The default setting: 1 A

- 5 Press and hold  for over one second.

Sets the clock shift type and returns the display to the previously viewed screen.

CLOCK TYPE	
1 A	
2 B	

Setting the program keys on the microphone (10 MIC PROGRAM KEY)

Assign functions to each program key ([P1] to [P4]) on the supplied microphone (MH-48).

- 1 Press and hold  for over one second.

The Setup menu appears.

- 2 Rotate the DIAL to select [8 CONFIG], then press .

SETUP MENU 7/123	
1 DISPLAY	5 SCAN
2 TX/RX	6 GM
3 MEMORY	7 WIRES-X
4 SIGNALING	8 CONFIG

- 3 Rotate the DIAL to select [10 MIC PROGRAM KEY], then press **(DISP SETUP)**.

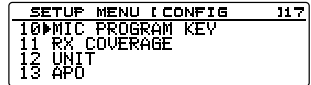

The microphone program key setting screen appears.

- 4 Rotate the DIAL to select the program key ([P1] to [P4]) to which you want to assign a function, then press **(DISP SETUP)**.

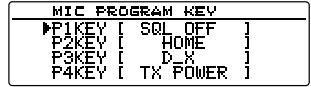

- 5 Rotate the DIAL to select the function you want to assign to the key, then press **(DISP SETUP)**.

- 6 Repeat the assigning operation for other keys.
Repeat the steps 4 to 5 to assign functions to other keys.

Function	Description
OFF	Deactivates the program key function
SQL TYPE	Changes the squelch type
SCAN	Starts/stops scanning (available while performing PMS)
HOME	Recalls the home channel
DCS CODE	Selects the DCS code
TONE FREQ	Selects the tone frequency
RPT SHIFT	Activates the repeater shift function
REVERSE	Reverse function
TX POWER	Sets the transmission power level
SQL OFF	Deactivates the squelch function
T-CALL	T-CALL function
VOICE	Announces the current frequency (available when the optional FVS-2 is attached)
D_X	Functions of the (D_X) key on the front panel
WX	Switches operation to the Weather Channel Bank
S-LIST	Displays the station list
MSG	Displays the message list
REPLY	Enters APRS reply message writing mode
M-EDIT	Enters APRS message writing mode

- 7 Press and hold **(DISP SETUP)** for over one second.

Assigns the selected function to the program key and returns the display to the previously viewed screen.

Tip The default setting: P1: SQL OFF
P2: HOME
P3: D_X
P4: TX POWER

Expanding the reception range (11 RX COVERAGE)

You can expand the reception range to receive the aircraft band frequencies (108 to 137 MHz) and the information band frequencies (174 to 400 MHz, 480 to 999.99 MHz) as well.

- 1 Press and hold **DISP SETUP** for over one second.

The Setup menu appears.

- 2 Rotate the DIAL to select **[8 CONFIG]**, then press **DISP SETUP**.

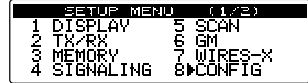

- 3 Rotate the DIAL to select **[11 RX COVERAGE]**, then press **DISP SETUP**.

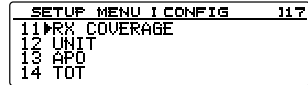

- 4 Rotate the DIAL to select the reception range.

1 NORMAL: Receives only 144 MHz and 430 MHz bands.

2 WIDE: Receives the aircraft band and information band as well.

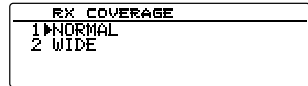

Tip The default setting: 1 NORMAL

- 5 Press and hold **DISP SETUP** for over one second.

Sets the reception range and returns the display to the previously viewed screen.

Setting the unit displayed on the screen (12 UNIT)

You can change the unit used for displaying the altitude, distance and speed.

- 1 Press and hold **DISP SETUP** for over one second.

The Setup menu appears.

- 2 Rotate the DIAL to select **[8 CONFIG]**, then press **DISP SETUP**.

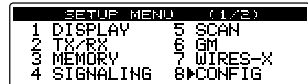

- 3 Rotate the DIAL to select **[12 UNIT]**, then press **DISP SETUP**.

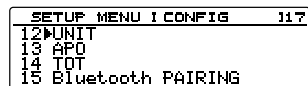

- 4 Rotate the DIAL to select the desired unit.

1 METRIC: Uses the metric system.

2 INCH: Uses the imperial system (US).

Tip The default setting: Depends on the transceiver version

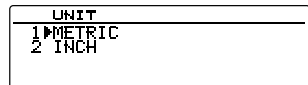

- 5 Press and hold **DISP SETUP** for over one second.

Sets the unit and returns the display to the previously viewed screen.

Turning off the transceiver automatically (13 APO)

You can set the transceiver so that it automatically turns off if you do not perform any operation for the designated time.

For details, see “Using the APO function” on page 94.

Limiting the continuous transmission time (14 TOT)

You can set the transceiver so that it automatically returns to receive mode after continuously transmitting for the designated time. (TOT...Time-Out-Timer)

For details, see “Using the TOT function” on page 95.

Setting the PIN code for the Bluetooth headset (15 Bluetooth PAIRING)

When a Bluetooth unit is installed in the transceiver, it may identify and be paired with the Bluetooth headset in use.

See “Identifying the Bluetooth headset” on page 155.

Setting the geodetic reference system (16 GPS DATUM)

You can set the geodetic reference system used for the GPS function positioning reference.

- 1 Press and hold **DISP SETUP** for over one second.
The Setup menu appears.

- 2 Rotate the DIAL to select **[8 CONFIG]**, then press **DISP SETUP**.

- 3 Rotate the DIAL to select **[16 GPS DATUM]**, then press **DISP SETUP**.

- 4 Rotate the DIAL to select the desired geodetic reference system.
 - 1 WGS-84: To use the global geodetic reference system for positioning. This is the standard used all around the world.
 - 2 TOKYO MEAN: To use the Japanese geodetic reference system for positioning. Reduces the chance of inaccuracies while positioning in Japan (Tokyo).

Tip The default setting: 1 WGS-84

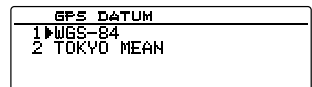
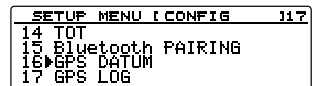
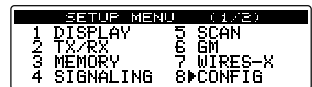

- 5 Press and hold  for over one second.

Sets the GPS function geodetic reference system and returns the display to the previously viewed screen.

Tip

Select “1 WGS-84” for the normal operation.

Setting the interval for saving the GPS location information (17 GPS LOG)

Set the interval for saving your location information onto the microSD memory card. For details, see “Saving location information (GPS Log Function)” on page 74.

Setup menu operations: 9 DATA

Setting the COM port (1 COM PORT SETTING)

Set the communication speed and functions when using the DATA jack on the rear panel of the transceiver as the COM port.

- 1 Press and hold **DISP SETUP** for over one second.
The Setup menu appears.

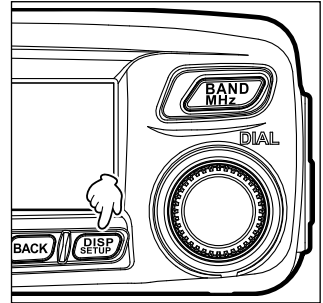

- 2 Rotate the DIAL to select **[9 DATA]**, then press **DISP SETUP**.

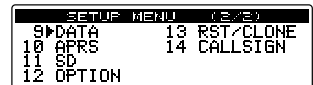

- 3 Rotate the DIAL to select **[1 COM PORT SETTING]**, then press **DISP SETUP**.

The detail settings screen appears.



- 4 Rotate the DIAL to select **[COM SPEED]**, then press **DISP SETUP**.



- 5 Rotate the DIAL to select the desired communication speed, then press **DISP SETUP**.

The setting switches as follows:

“4800 bps” → “9600 bps” → “19200 bps” → “38400 bps” → “57600 bps”

Tip The default setting: 9600 bps

- 6 Rotate the DIAL to select **[COM OUTPUT]**, then press **DISP SETUP**.



- 7 Rotate the DIAL to select the information you want to output.

“OFF” → “GPS OUT” → “PACKET” → “WAYPOINT”

OFF: Does not use the COM port output function (deactivate the function).

GPS OUT: Outputs the GPS data that the transceiver acquired.

PACKET: Outputs the AX.25 packet communication data received using the internal modem function.

WAYPOINT: Outputs the beacon location information of other stations you can acquire from the received APRS packet as WAYPOINT data.

Tip The default setting: OFF

8 Press **BACK**.

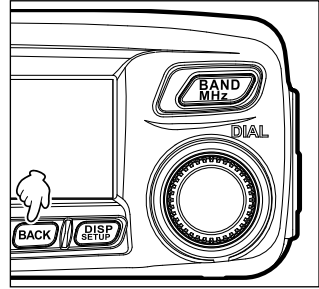

9 Rotate the DIAL to select **[WP FORMAT]**, then press **DISP SETUP**.

COM PORT SETTING	
COM SPEED	1 9600bps
COM OUTPUT	OFF
WP FORMAT	1 NMEA 9
WP FILTER	1 ALL

10 Rotate the DIAL to select the number of digits of the APRS beacon station call sign information which is added to each data.

This setting is required when “WAYPOINT” is selected in step 8. The data is output in the NMEA-0183 \$GPWPL format.

The setting switches as follows:

“NMEA 9” → “NMEA 8” → “NMEA 7” → “NMEA 6”

NMEA 9: Displays the last 9 digits of the call sign (Example: JQ1YBG-14 is output as “JQ1YBG-14”).

NMEA 8: Displays the last 8 digits of the call sign (Example: JQ1YBG-14 is shortened to “Q1YBG-14”).

NMEA 7: Displays the last 7 digits of the call sign (Example: JQ1YBG-14 is shortened to “1YBG-14”).

NMEA 6: Displays the last 6 digits of the call sign (Example: JQ1YBG-14 is shortened to “YBG-14”).

Tip The default setting: NMEA 9

11 Press **BACK**.

12 Rotate the DIAL to select **[WP FILTER]**, then press **DISP SETUP**.

COM PORT SETTING	
COM SPEED	1 9600bps
COM OUTPUT	OFF
WP FORMAT	1 NMEA 9
WP FILTER	1 ALL

13 Rotate the DIAL to select the beacon type you want to output.

This setting is required when “WAYPOINT” is selected in step 7.

The setting switches as follows:

“ALL” → “MOBILE” → “FREQUENCY” → “OBJECT/ITEM” → “DIGIPEATER” → “VoIP” → “WEATHER” → “YAESU” → “CALL RINGER” → “RNG RINGER”

ALL: Outputs all the received beacons.

MOBILE: Outputs only mobile station beacons.

FREQUENCY: Outputs only the beacons of stations with frequency information.

OBJECT/ITEM: Outputs only the beacons of object stations or item stations.

DIGIPEATER: Outputs only the beacons of digital repeater stations.

VoIP: Outputs only beacons of VoIP stations such as WIRES.

WEATHER: Outputs only beacons of the weather station.

YAESU: Outputs only beacons of stations which are using Yaesu transceivers.

CALL RINGER: Outputs only the information of call sign ringer stations which are set from **[9 APRS RINGER (CALL)]** in the APRS Setup menu.

RNG RINGER: Outputs only the information of stations recognized as an approaching station by the **[8 APRS RINGER]** range ringer function in the APRS Setup menu.

Tip The default setting: ALL

- 14** Press and hold **(DISP SETUP)** for over one second.

Sets the COM port and returns the display to the previous operating screen.

Setting the APRS and data communication speed (2 DATA SPEED)

Set the communication speed of the APRS (internal modem) and data communications (when using the DATA jack on the rear panel of the transceiver).

- 1** Press and hold **(DISP SETUP)** for over one second.

The Setup menu appears.

- 2** Rotate the DIAL to select **[9 DATA]**, then press **(DISP SETUP)**.

SETUP MENU (PAGE)	
9 DATA	13 RST/CLONE
10 APRS	14 CALLSIGN
11 SD	
12 OPTION	

- 3** Rotate the DIAL to select **[2 DATA SPEED]**, then press **(DISP SETUP)**.

The detail settings screen appears.

SETUP MENU [DATA]	
1 COM PORT SETTING	
2 DATA SPEED	
3 DATA SQUELCH	

- 4** Rotate the DIAL to select **[APRS]**, then press **(DISP SETUP)**.

DATA SPEED	
APRS: [1200 bps]	
DATA: [1200 bps]	

- 5** Rotating the DIAL changes the speed between “1200 bps” and “9600 bps”.

1200 bps: Sets the speed to AFSK1200bps packet.

9600 bps: Sets the speed to GMSK9600bps packet.

Tip The default setting: 1200 bps

- 6** Press **(BACK)**.

- 7** Rotate the DIAL to select **[DATA]**, then press **(DISP SETUP)**.

Repeat step 5 to set the data communication speed.

Tip The default setting: 1200 bps

- 8** Press and hold **(DISP SETUP)** for over one second.

Setup menu operations: 9 DATA

Sets the communication speed of APRS and data communication and returns the display to the previously viewed screen.

Snquelch detection and snquelch jack output settings (3 DATA SQUELCH)

Set the snquelch detection condition for APRS (internal modem) operations and snquelch jack output condition for data communications (when using the DATA jack on the rear panel of the transceiver). See “Setting the packet communication operation” on page 112.

Setup menu operations: 10 APRS

The transceiver is equipped with the APRS function which enables receiving and transmitting GPS location data, information and messages in the APRS format. For details, refer to the APRS Instruction Manual (download from Yaesu website).

Setup menu operations: 11 SD

Copying the transceiver settings to a microSD memory card (1 BACKUP)

Using a microSD memory card, the information registered to the memory channels, and the Setup menu settings may be recorded and transferred to other FTM-100DR transceivers.

The settings saved on a microSD memory card may be imported to your transceiver. For details, see “Copying the radio data to another transceiver” on page 104.

Initializing a microSD memory card (2 FORMAT)

When using a new microSD memory card, initialize the memory card. For details, see “Initializing microSD memory cards” on page 33.

Setup menu operations: 12 OPTION

Setting the Bluetooth headset operations (1 Bluetooth)

You can wirelessly receive and transmit voice messages using the Bluetooth headset by installing the Bluetooth unit onto the transceiver.

For details, see “Setting the Bluetooth headset operations” on page 153.

Setting the voice memory operations (2 VOICE MEMORY)

By installing the voice guide unit onto the transceiver, you can record and play received audio, and also record and play audio from the microphone.

For details, see “Using the voice memory” on page 160.

Setup menu operations: 13 RST/CLONE

Resetting the transceiver settings (1 FACTORY RESET)

You can restore the transceiver configuration and memory registration settings to the default state. For details, see “Restoring defaults (All Reset)” on page 49.

Presetting (2 PRESET)

You can preset one desired setting value such as a frequency or memory channel.

- 1 Press and hold **DISP SETUP** for over one second.
The Setup menu appears.

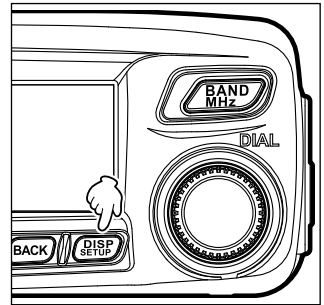

- 2 Rotate the DIAL to select **[13 RST/CLONE]**, then press **DISP SETUP**.

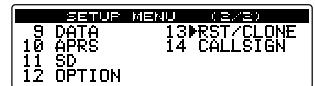

- 3 Rotate the DIAL to select **[2 PRESET]**, then press **DISP SETUP**.
The preset confirmation screen appears.

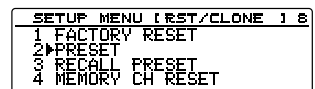

- 4 Rotate the DIAL to select **[OK?]**, then press **DISP SETUP**.
Presets the desired setting value.
To cancel the preset operation, select **[Cancel]**, then press **DISP SETUP**.



Setup menu operations: 13 RST/CLONE

- Press and hold **DISP SETUP** for over one second.
Returns the display to the previous operating screen.

Recalling the preset setting (3 RECALL PRESET)

You can recall the preset setting from the Setup menu.

- Press and hold **DISP SETUP** for over one second.
The Setup menu appears.
- Rotate the DIAL to select **[13 RST/CLONE]**, then press **DISP SETUP**.

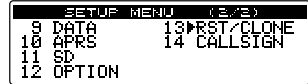

- Rotate the DIAL to select **[3 RECALL PRESET]**, then press **DISP SETUP**.

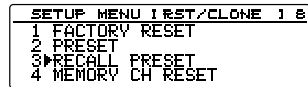

The confirmation screen appears.

- Rotate the DIAL to select **[OK?]**, and then press **DISP SETUP**.



Recalls the preset setting and returns the display to the previously viewed screen.

To cancel the Setup menu without any change, select **[Cancel]**, then press **DISP SETUP**.

- Press and hold **DISP SETUP** for over one second.
Returns the display to the previously viewed screen.

Deleting the registered data from the memory channels (4 MEMORY CH RESET)

Deletes the registered data from the memory channels.

- Press and hold **DISP SETUP** for over one second.
The Setup menu appears.
- Rotate the DIAL to select **[13 RST/CLONE]**, then press **DISP SETUP**.
The menu list appears.
- Rotate the DIAL to select **[4 MEMORY CH RESET]**, then press **DISP SETUP**.

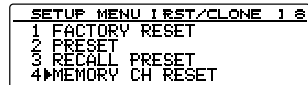

- Rotate the DIAL to select **[OK?]**, and then press **DISP SETUP**.

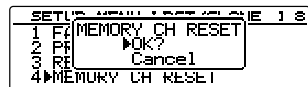

Tip To cancel resetting, select **[Cancel]**.

Deletes the registered data from the memory channels and returns the screen to the previously viewed screen.

Sorting the memory channels (5 MEMORY CH SORT)

Sort the memory channels where data registered.

- 1 Press and hold **DISP SETUP** for over one second.
The Setup menu appears.
- 2 Rotate the DIAL to select **[13 RST/CLONE]**, then press **DISP SETUP**.
The menu list appears.
- 3 Rotate the DIAL to select **[5 MEMORY CH SORT]**, then press **DISP SETUP**.
- 4 Rotate the DIAL to select **[OK?]**, and then press **DISP SETUP**.

Tip To cancel sorting, select **[Cancel]**.

Sorts the memory channels in ascending order of frequency.
The transceiver restarts.

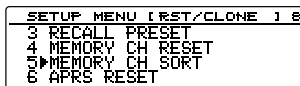
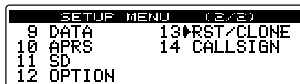

Resetting the APRS setting (6 APRS RESET)

Reset the APRS setting.

- 1 Press and hold **DISP SETUP** for over one second.
The Setup menu appears.
- 2 Rotate the DIAL to select **[13 RST/CLONE]**, then press **DISP SETUP**.
The menu list appears.
- 3 Rotate the DIAL to select **[6 APRS RESET]**, then press **DISP SETUP**.
- 4 Rotate the DIAL to select **[OK?]**, and then press **DISP SETUP**.

Tip To cancel resetting, select **[Cancel]**.

Resets the APRS setting and returns the screen to the previously viewed screen.

Copying the saved data (7 CLONE)

All the data saved on the transceiver directory may be copied (Cloned) to other FTM-100DR transceivers.

For details, see “Using the clone function” on page 106.

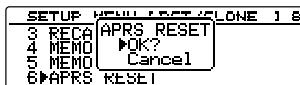
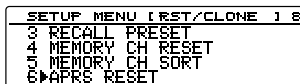

Setup menu operations: 14 CALLSIGN

Changing the call sign (1 MY CALLSIGN (DIGITAL))

The call sign ID registered to the transceiver may be changed using the set menu.

- 1 Press and hold **DISP SETUP** for over one second.
The Setup menu appears.

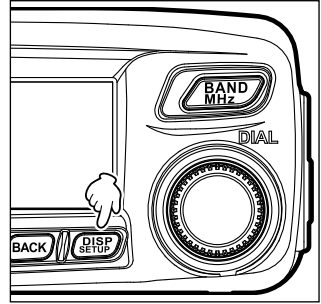

- 2 Rotate the DIAL to select **[14 CALLSIGN]**, then press **DISP SETUP**.



- 3 Press **DISP SETUP**.
The currently registered call sign ID is shown.



- 4 Press **DISP SETUP**.
The first letter of the call sign ID blinks.



- 5 Rotate the DIAL to select the desired letter, then press **GM** (**→** appears on the upper row).
The cursor moves to the right.

- Tips**
- Up to 10 alphanumeric characters including hyphen and slash may be input.
 - To switch the input screen (uppercase letters, lowercase letters, symbols and numbers), press **TXPD** (**↕** appears on the upper side).
 - To delete the letter you have just input, press **V/M MW** (**CLR** appears on the upper side).
 - To move the cursor to the left, press **←** (**←** appears on the upper side).
 - To delete the letter you have just entered and move the cursor to the left, press **SOL VOICE** (**←X** appears on the upper row).

- 6 Repeat step 5 to complete to input the new call sign.
- 7 Press **DISP SETUP**.
Displays the new call sign.

- 8 Press and hold **DISP SETUP** for over one second.
Sets the call sign and returns the display to the previously viewed operating screen.

Using the Optional Accessories

(Bluetooth Devices/Voice Unit)

Using the Bluetooth headset

You can operate receive and transmit using the optional wireless Bluetooth unit “BU-2” and Bluetooth headset “BH-2A”.

Activating the VOX (Voice Operated Xmit) function enables hands-free communications

Tip

Bluetooth headsets other than the optional Yaesu headset may also be used, however not all the functions are guaranteed to work properly.

Mounting the Bluetooth unit “BU-2”

● What to prepare

- Bluetooth unit “BU-2” (optional)
- Phillips-head screwdriver

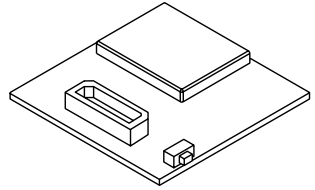

● Mounting procedure

Cautions

- Avoid touching the IC components with your hands as the semiconductors may be damaged by static electricity.
- Note that installation of optional items may incur additional labor charges.

- 1 Turn off the transceiver.
- 2 Turn off the external device.
- 3 Disconnect the control cable, microphone cable and DC power cable.
- 4 Remove the 8 screws in total from the transceiver (4 screws from the top panel and 2 screws from the right and left sides).

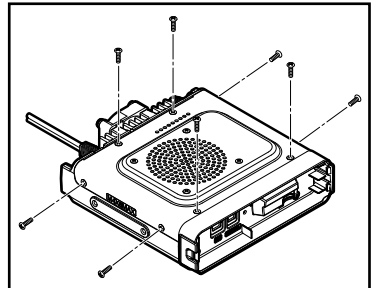

Using the Bluetooth headset

- 5 Gently lift up the top cover of the transceiver from the rear side.

Caution Do not abruptly open the top cover. Doing so may break the cable connecting the internal speaker to the main board.

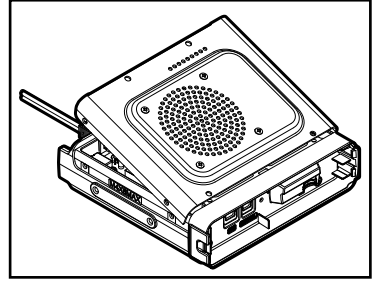

- 6 Unplug the speaker cable from the socket on the main board to completely remove the top cover from the transceiver.

Caution When unplugging the speaker cable, do not pull the cable. Be sure to hold the connector part.

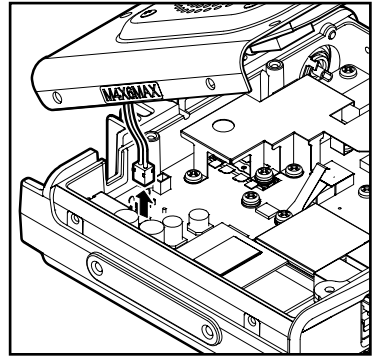

- 7 Remove the 2 screws from the front panel.
8 Release the latch at the center of the cover to remove the front cover.

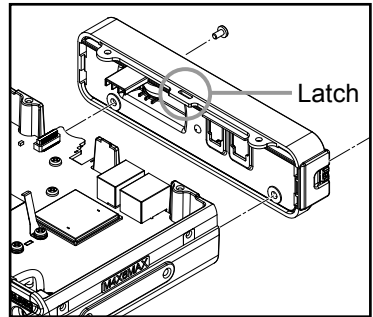

- 9 Refer to the illustration on the right to plug BU-2 to the connector.

Caution Check the direction of the connector and plug BU-2 all the way into the connector.

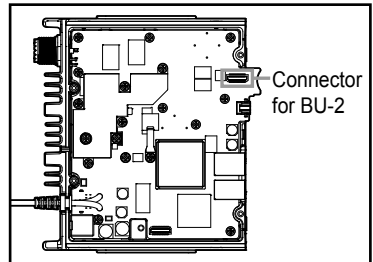

- 10 Attach the front cover using the 2 screws.

- 11 Reconnect the speaker cable extending from the top cover to the socket on the main board.
- 12 Attach covers using the 8 screws.

Setting the Bluetooth headset operations

The following settings may be changed for convenient wireless headset operation according to your personnel preferences.

- Listening to receive audio using the headset only, or listening with both the headset and the transceiver speaker
- Saving the headset battery power
- Switching between transmit and receive with [PTT], or automatically switching to transmit when you begin speaking [VOX]
- The [VOX] gain may be set to automatically switch to transmit upon detecting voices including low volume sounds

- 1 Turn on the transceiver
- 2 Press and hold  for over one second.
The Setup menu appears.

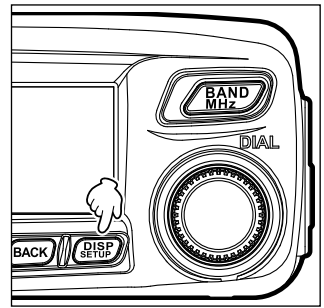

- 3 Rotate the DIAL to select [12 OPTION], then press .



- 4 Rotate the DIAL to select [1 Bluetooth], then press .

Tip This option can be selected only when BU-2 is installed into the transceiver.

The settings screen appears.



- 5 Rotate the DIAL to select [1 AUDIO], then press .

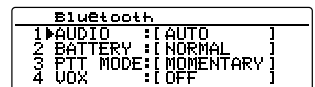

- 6 Rotate the DIAL to select "AUTO" or "FIX".

"AUTO": When a Bluetooth headset is connected, the audio from the radio speaker is muted and sound is heard only from the headset.

"FIX": Audio can be heard from both the Bluetooth headset and the speaker of the transceiver.

Tip The default setting: AUTO

Using the Bluetooth headset

7 Press **BACK**.

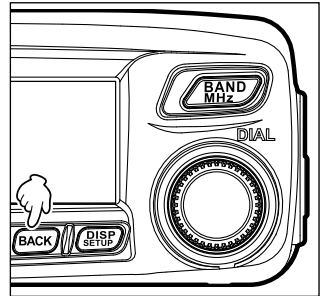

8 Rotate the DIAL to select **[2 BATTERY]**, then press **DISP SETUP**.

Bluetooth			
1	AUDIO	: I AUTO	
2	BATTERY	: I NORMAL	
3	PTT MODE	: I MOMENTARY	
4	VOX	: I OFF	

9 Rotate the DIAL to select “NORMAL” or “SAVE”.

“NORMAL”: Deactivates the battery saving function for the Bluetooth headset.

“SAVE”: Activates the battery saving function for the Bluetooth headset.

Tip The default setting: NORMAL

10 Press **BACK**.

11 Rotate the DIAL to select **[3 PTT MODE]**, then press **DISP SETUP**.

Bluetooth			
1	AUDIO	: I AUTO	
2	BATTERY	: I NORMAL	
3	PTT MODE	: I MOMENTARY	
4	VOX	: I OFF	

12 Rotate the DIAL to select “MOMENTARY” or “TOGGLE”.

“MOMENTARY”: Remains in transmit mode while pressing and holding [PTT] on the headset.

“TOGGLE”: Pressing [PTT] on the headset each time switches between transmit and receive.

Tip The default setting: MOMENTARY

13 Press **BACK**.

14 Rotate the DIAL to select **[4 VOX]**, then press **DISP SETUP**.

Bluetooth			
1	AUDIO	: I AUTO	
2	BATTERY	: I NORMAL	
3	PTT MODE	: I MOMENTARY	
4	VOX	: I OFF	

15 Rotate the DIAL to select “OFF” or “ON”.

“OFF”: Transmit and receive can be switched by pressing [PTT].

“ON”: Transmit and receive are switched when audio is detected.

Tip The default setting: OFF

16 Press **BACK**.

When **[VOX]** is set to “ON”, the **[5 GAIN]** setting will be shown.

17 Rotate the DIAL to select **[GAIN]**, then press **DISP SETUP**.
Displays the setting options.

Bluetooth			
2	BATTERY	: I NORMAL	
3	PTT MODE	: I MOMENTARY	
4	VOX	: I ON	
5	GAIN	: I HIGH	

18 Rotate the DIAL to select “HIGH” or “LOW”.

“HIGH”: Increases the Bluetooth headset VOX sensitivity to detect low volume sounds.

“LOW”: Decrease the Bluetooth headset VOX sensitivity so that low volume sounds are not detected.

19 Press **BACK**.**20** Press and hold **DISP SETUP** for over one second.

Sets the Bluetooth headset operation and returns the display to the previously viewed screen.

Identifying the Bluetooth headset

An individual identification code known as a “PIN code” is assigned to Bluetooth devices such as a headset. When connecting Bluetooth devices for the first time, registration is required. This process is called pairing. The PIN codes are used for registering each other. Through pairing, interference and improper interception can be prevented. When using the Bluetooth headset together with the transceiver for the first time, pairing is also required.

Tip

The PIN code for the Yaesu Bluetooth headset BH-2A is “6111”. When using a Bluetooth headset manufactured by other companies, check the PIN code in the operating manual of the product.

Example: When pairing with the optional Bluetooth headset BH-2A

Tip

For details on how to pair with a headset other than BH-2A, refer to the operation manual of the connection product.

1 Turn off BH-2A.**2** Press and hold **DISP SETUP** on the transceiver for over one second.

The Setup menu appears

3 Rotate the DIAL to select **[8 CONFIG]**, then press

DISP SETUP.

The menu list screen appears.

4 Rotate the DIAL to select **[15 Bluetooth PAIRING]**, then press **DISP SETUP**.





SETUP MENU [1/2]	
1 DISPLAY	SCAN
2 TX/RX	GM
3 MEMORY	WIRES-X
4 SIGNALING	8 CONFIG

SETUP MENU [CONFIG 1/7]	
12 UNIT	
13 APD	
14 TDT	
15 Bluetooth PAIRING	

Using the Bluetooth headset

The PIN code input screen appears.

Tips • In the default setting, “6111” appears.

- When using a headset other than BH-2A, input the device's 4-digit PIN code here. Rotate the DIAL to move the cursor to overwrite letters.
- Press the  key to move the cursor to the left (the  appears on the upper side).
- Press the  key to move the cursor to the right (the  appears on the upper side).

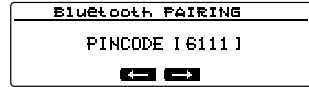

5 Press and hold the BH-2A power switch for over 5 seconds.

The indicator on BH-2A blinks alternately between red and blue.

6 Press .

“Pairing...” appears.

When pairing successfully completes, “Completed” appears and the display returns to the menu list screen.

The indicator on BH-2A blinks blue.

Caution If “ERROR” appears, repeat the operation from the beginning.

7 Press and hold  for over one second.

Returns the display to the previous screen.

Displays the  icon at the top right of the screen.

Tips

- BU-2 can be paired with up to 8 other devices. When using 2 or more headsets such as a spare one or a personal one, set up the respective PIN codes and pair with each device in advance. However, 2 headsets cannot be used at the same time.
- When pairing is conducted successfully with the 9th device, the oldest device pairing information will be deleted.

Using the Bluetooth headset

Once paired, the headset can be used simply by turning on the power.

Tips

- The communication distance between the headset and the transceiver is about 10 m or less.
- The  icon does not appear when the headset is too far from the transceiver and outside the sphere of communication.

(1) When not using the VOX function

- 1 Turn on the headset.
The receive audio will be heard from the headset speaker.
- 2 Briefly press [PTT] on the headset.
The transceiver goes into transmit mode.
- 3 Briefly press [PTT] on the headset again.
The transceiver goes into receive mode.

(2) When using the VOX function

- 1 Turn on the headset.
The receive audio will be heard from the headset speaker.
- 2 Speak into the headset microphone.
The transceiver goes into transmit mode.
Tip When you stop talking, the transceiver automatically returns to receive mode.

Recording and listening to received audio

You can record and playback the receiver audio using the optional voice guide unit “FVS-2”.

By activating the announcement function, you can also hear the synthesized voice announcing the frequency of the operating band.

Mounting the voice guide unit “FVS-2”

● What to prepare

- Voice guide unit “FVS-2” (optional)
- Phillips-head screwdriver

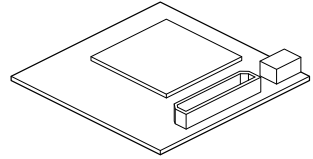

● Mounting procedure

Cautions

- Avoid touching the IC components with your hands as the semiconductors may be damaged by static electricity.
- Note that installation of optional items may incur additional labor charges.

- 1 Turn off the transceiver.
- 2 Turn off the external device.
- 3 Disconnect the control cable, microphone cable and DC power cable.
- 4 Remove the 8 screws in total from the transceiver (4 screws from the top panel and 2 screws from the right and left sides).

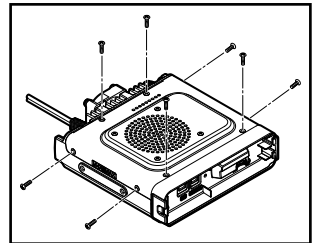

- 5 Gently lift up the top cover of the transceiver from the rear edge.

Caution Do not abruptly open the top cover. Doing so may break the cable connecting the internal speaker to the main board.

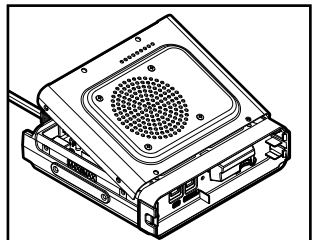

- 6** Unplug the speaker cable from the socket on the main board to completely remove the top cover from the transceiver.

Caution When unplugging the speaker cable, do not pull the cable. Be sure to hold the connector part.

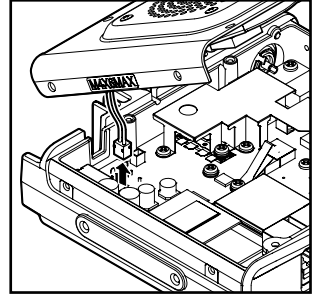

- 7** Refer to the illustration on the right and carefully plug the FVS-2 into the connector.

Caution Check the direction of the connector and press the FVS-2 all the way into the connector.

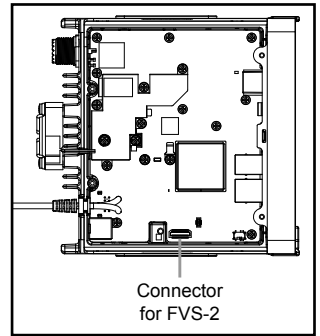

- 8** Reconnect the speaker cable plug extending between from the top cover to the socket on the main board.
- 9** Attach the covers using the 8 screws.

Using the voice memory

The voice memory is a function for recording the received audio. The audio is saved onto the FVS-2 module that is mounted to the transceiver. The saved audio can be replayed and erased later on the transceiver.

Setting the voice memory operation

- 1 Turn on the transceiver.
- 2 Press and hold **DISP SETUP** for over one second.
The Setup menu appears.
- 3 Rotate the DIAL to select **[12 OPTION]**, then press **DISP SETUP**.
- 4 Rotate the DIAL to select **[2 VOICE MEMORY]**, then press **DISP SETUP**.
The detail settings screen appears.
- 5 Rotate the DIAL to select **[1 PLAY/REC]**, then press **DISP SETUP**.
- 6 Rotate the DIAL to select the recording time.
“FREE 5min”: Records 8 sections for 5 minutes in total.
“LAST 30sec”: Records the last 30 seconds.
Tip The default setting: FREE 5min
- 7 Press and hold **DISP SETUP** for over one second.
Returns the display to the previously viewed screen.

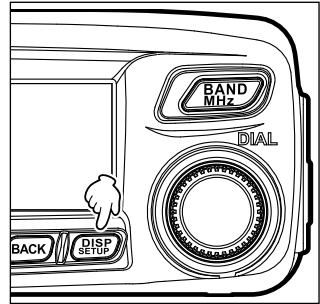

SETUP MENU (2/2)	
9 DATA	13 RST/CLONE
10 APRS	14 CALLSIGN
11 SD	
12 OPTION	

SETUP MENU OPTION 1	
1 Bluetooth	
2 VOICE MEMORY	

VOICE MEMORY	
1 PLAY/REC:1 FREE 5min	1
2 ANNOUNCE:1 AUTO	1
3 LANGUAGE:1 JAPANESE	1
4 VOLUME :1 HIGH	1

Recording the received audio

- 1 Press and hold **SQL VOICE** for over one second.
The menu appears in the bottom area of the screen.

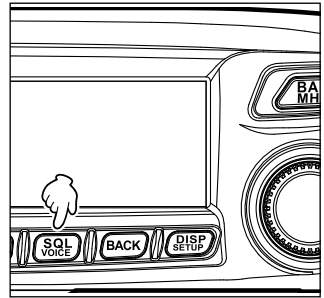

- 2 Press **REC** (**REC** appears on the display).
Recording begins.
Tip The recording time you set from [12 OPTION] → [2 VOICE MEMORY] in the Setup menu appears below [REC].

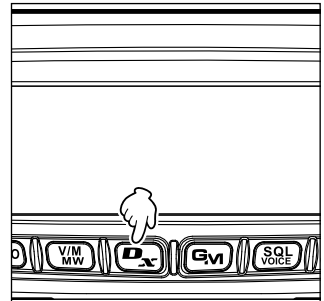

- 3 Press **BACK** (**STOP** appears on the display).
Recording stops.
Also [TRACK], and the track number of the recording are shown on the display.

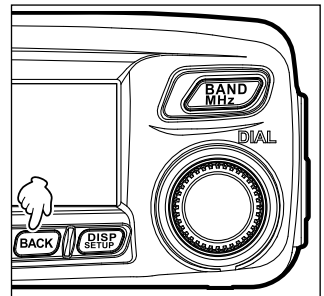

- 4 Press and hold **SQL VOICE** for over one second.
Returns the display to the previously viewed screen.

Playing the recorded audio

- 1 Press and hold **(SQL VOICE)** for over one second.
The menu appears in the bottom area of the screen.
- 2 Press **Gm** (**(TRK)** appears on the display) to select the desired track number.
Tips
 - If there are two or more recordings, pressing each time switches the track number: "ALL", "1", "2", ...
 - If "ALL" is selected, all of the recorded tracks will be played back in order.

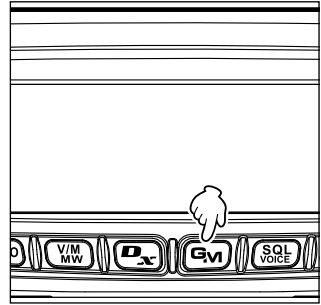

- 3 Press and hold **(SQL VOICE)** for over one second (**(FLY)** appears on the display).
Playback begins
After playing to the end of the selected track, playback stops automatically.
To stop playback midway, press **(BACK)** (**(STOP)** appears on the display).
- 4 Press and hold **(SQL VOICE)** for over one second.
Returns the display to the previously viewed screen.



Erasing the recorded audio

- 1 Press and hold **(SQL VOICE)** for over one second.
The menu appears at the bottom area of the screen.
- 2 Press **(TXPO)** (**(Erase)** appears on the display).
The confirmation screen appears.

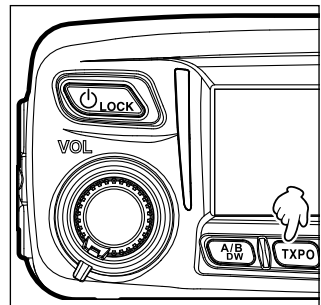

- 3 Rotate the DIAL to select **[OK?]**, then press **(DISP SETUP)**.
The recordings are erased.

Caution This operation erases all the recorded audio. Even when there are 2 or more tracks, individual tracks cannot be erased.

After erasing completes, "ALL" appears for **[TRCK]**.

- 4 Press and hold **(SQL VOICE)** for over one second.
Returns the display to the previously viewed screen.



Activating the frequency voice announcement

Setting the announcement function operation

The following settings may be customized:

- Setting how an announcement is initiated.
- Selecting the language
- Setting the announcement volume level
- Muting the receive audio while announcements are being made

- 1 Press and hold **(DISP SETUP)** for over one second.
The Setup menu appears.

- 2 Rotate the DIAL to select **[12 OPTION]**, then press **(DISP SETUP)**.

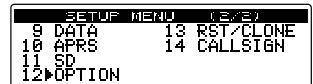

- 3 Rotate the DIAL to select **[2 VOICE MEMORY]**, then press **(DISP SETUP)**.
The detail setting screen appears.



- 4 Rotate the DIAL to select **[2 ANNOUNCE]**, then press **(DISP SETUP)**.



- 5 Rotate the DIAL to select the desired setting.

“AUTO”: Makes announcements when pressing and holding **(SQL VOICE)** for over one second or when changing the band.

“OFF”: Deactivate the announcement function.

“MANUAL”: Makes announcements when pressing and holding **(SQL VOICE)** for over one second.

Tip The default setting: AUTO

- 6 Press **(BACK)**.

- 7 Rotate the DIAL to select **[3 LANGUAGE]**, then press **(DISP SETUP)**.



Recording and listening to received audio

- 8 Rotate the DIAL to select the desired language.

Rotating the DIAL each time switches the language between “JAPANESE” and “ENGLISH”.

Tip The default setting: ENGLISH

- 9 Press **BACK**.

- 10 Rotate the DIAL to select **[4 VOLUME]**, then press

DISP
SETUP.

VOICE MEMORY	
1	PLAY/REC: I FREE 5min I
2	ANNOUNCE: I AUTO I
3	LANGUAGE: I JAPANESE I
4	VOLUME : I HIGH I

- 11 Rotate the DIAL to select the desired announcement volume level.

Rotating the DIAL each time changes the setting in the following order: “HIGH” → “MID” → “LOW”.

Tip The default setting: HIGH

- 12 Rotate the DIAL to select **[5 RX MUTE]**, then press

DISP
SETUP.

VOICE MEMORY	
2	ANNOUNCE: I AUTO I
3	LANGUAGE: I JAPANESE I
4	VOLUME : I HIGH I
5	RX MUTE : I ON I

- 13 Rotate the DIAL to select the desired mute function setting.

Rotating the DIAL each time switches the setting between on and off.

“ON”: Mutes the reception sound when speaking or playing recorded voice.

“OFF”: Does not mute the reception sound even when speaking or playing recorded voice.

- 14 Press and hold **DISP** for over one second.

Sets the announcement function operation and returns the display to the previously viewed screen

Activating to the frequency announcement

(1) When the function operation is set to “AUTO”

Automatically makes an announcement in the following situations:

- When switching the mode between memory mode and VFO mode
- When changing the operating band

Tip

You can also adjust the volume level by rotating the DIAL.

(2) When the function operation is set to “MANUAL”

- 1 Press and hold **SOL** for over one second.

Announces the operating band frequency.

Tip

You can also adjust the volume level by rotating the DIAL.

Optional components

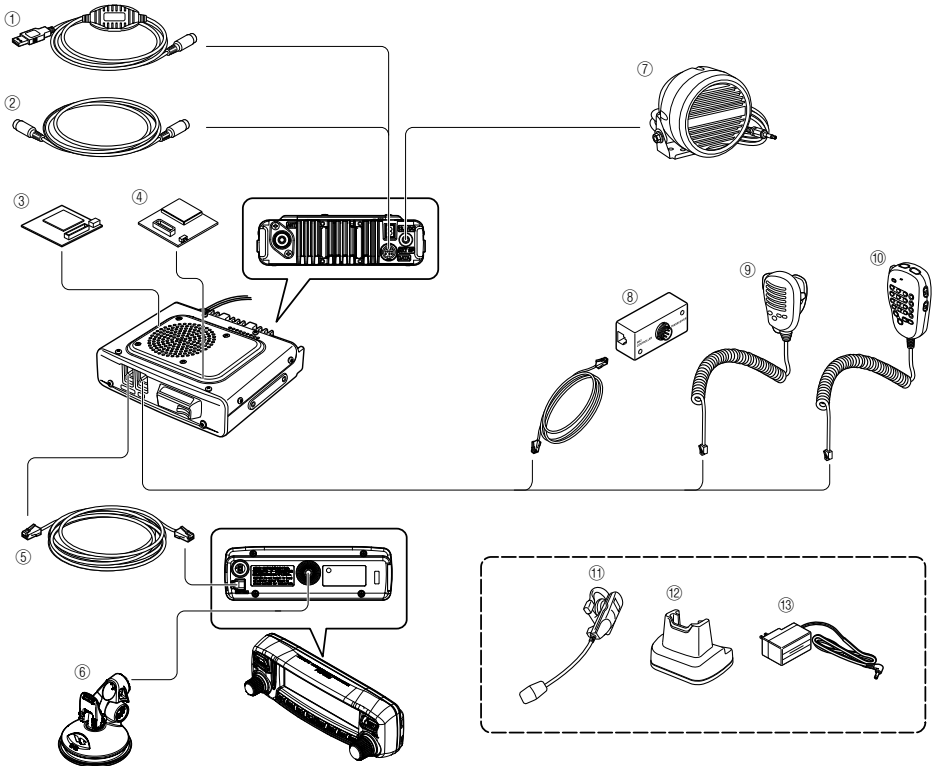

① PC connection cable (SCU-20)

*Same as the one provided

② Cloning cable (CT-166)

③ Voice guide unit (FVS-2)

④ Bluetooth unit (BU-2)

⑤ 6m control cable (CT-162)

⑥ Front panel bracket (MMB-98)

⑦ Water proof (equivalent to IP55) high power external speaker (MLS-200-M10)

⑧ Microphone extension kit (MEK-2)

⑨ Microphone (MH-42C6J)

⑩ Multifunctional DTMF microphone (MH-48A6JA)

*Same as the one provided

⑪ Waterproof Bluetooth headset (monaural) (BH-2A)

⑫ Charging cradle for BH-2A (CD-40)

⑬ Battery charger for CD-40 (PA-46A)

● Desktop Cooling Fan (SMB-201)

● AC Power Supply (25 A) (FP-1030A) (USA and Asian market only)

● AC Power Supply (23 A) (FP-1023) (USA market only)

● Data cable (CT-163): DIN 10 pin ↔ DIN 6 pin + Dsub 9 pin

● Data cable (CT-164): DIN 10 pin ↔ DIN 6 pin

● Data cable (CT-165): DIN 10 pin ↔ Dsub 9 pin

● Data cable (CT-167): DIN 10 pin ↔ Split end (10 pin)

Care and maintenance

Turn the power OFF before wiping away any dust and stains on the transceiver with a dry soft cloth. For stubborn stains, slightly moisten a soft cloth and wring it out before using it to wipe away the stains.

Caution Never use washing detergents and organic solvents (thinner, benzene, etc.). Doing so may result in paint flaking or damage to the transceiver finish.

Replacing the fuse

When the fuse of the DC power supply cable blows and the transceiver becomes inoperable, correct the cause of the problem, and then replace the fuse with a new one of the correct (15 Amp) rating.

Caution When replacing the fuse, be sure to disconnect the power supply cable from the transceiver and from the external DC power supply.

● Replacing the fuse of the DC power supply cable

- 1 Prepare a new fuse.

Use a fuse with a rating of 15A.

Caution Never attempt to use a fuse that is not of the specified rating

- 2 Open the fuse holder as shown in the diagram on the right.

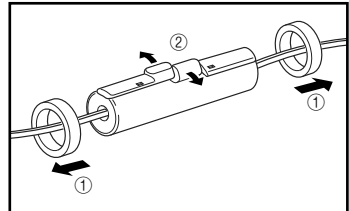

- 3 Remove the blown fuse.

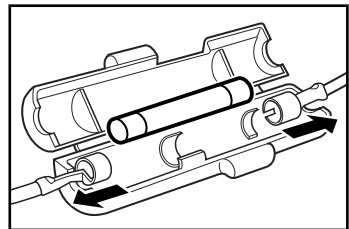

- 4 Attach the new fuse.
- 5 Close the fuse holder.

Troubleshooting

Caution

Check the following before requesting repair services.

There is no power

- Is the external power supply connected correctly?
Connect the black wire to the negative (-) terminal and the red wire to the positive (+) terminal.
- Is the voltage and current capacity of the external power supply sufficient?
Check the voltage and current capacity of the external power supply.
Voltage: 13.8 V
Current capacity: 20 A or higher
- Is the fuse blown?
Replace the fuse.

There is no sound

- Is the squelch level or setting too high?
Adjust the squelch level when receiving weak signals.
- Is the volume low?
Increase the volume by turning the VOL knob in the clockwise direction.
- Is the tone squelch or DCS set to on?
When the tone squelch or DCS is turned on, no sound will be heard until signals containing the set tone frequency or DCS code corresponding to the set code are received.
- Is the external speaker connected?
Properly connect a speaker with an impedance of 4 to 16 Ω .
- Is the Bluetooth headset in use?
Disable the use of the headset or use the Setup menu to allow sound to come from both the headset and the internal speaker.

There is no transmission

- Is the PTT button pressed properly?
- Is the microphone connected correctly?
Plug the connector all the way into the MIC jack.
- Is the transmit frequency set to the amateur band?
Transmission outside the amateur band is not possible.
- Is the antenna or co-axial cable broken?
Replace the antenna or co-axial cable.
- Is the voltage of the external power supply normal?
When the voltage of the power supply drops during transmission, the transceiver may not run at full performance.
Use a stable DC power supply with a direct current of 13.8 V and a current capacity of 20 A.

The keys or knobs do not operate

- Is the lock function activated?
Cancel the lock by briefly pressing the Power/LOCK key.

About internal spurious signals

Certain frequency combinations of signals received simultaneously, may have an effect such as internal beats due to the high frequency of the internal oscillator. However, this is not a malfunction (refer to the calculation formulas below: n is any integer). Depending on the combination of the frequencies received simultaneously, there may also be fluctuations in the receiver sensitivity.

- Reception frequency = 12.288 MHz x n times
- Reception frequency = 15.6 MHz x n times
- Reception frequency = 2.4576 MHz x n times
- Reception frequency = 6.1444 MHz x n times
- Reception frequency = 11.1 MHz x n times
- Reception frequency = 18.432 MHz x n times
- Upper (A-band) frequency = (Lower (B-band) frequency \pm 44.85 MHz) \times n times
- Lower (B-band) frequency = (Upper (A-band) frequency \pm 47.25 MHz) \times n times @ Upper band (A-band) MODE = NFM

Specifications

● General

Frequency range	: TX 144 - 146 MHz or 144 - 148 MHz 430 - 440 MHz or 430 - 450 MHz
	: RX 108 - 137 MHz (Air Band) 137 - 174 MHz (144 MHz HAM) 174 - 400 MHz (GEN1) 400 - 480 MHz (430 MHz HAM) 480 - 999.99 MHz (GEN2) Cellular Blocked (USA only)
Channel steps	: 5/6.25/8.33/10/12.5/15/20/25/50/100 kHz (8.33 kHz : only for Air band)
Emission Type	: F1D, F2D, F3E, F7W
Frequency stability	: ± 2.5 ppm -4°F to $+140^{\circ}\text{F}$ (-20°C to $+60^{\circ}\text{C}$)
Antenna impedance	: 50 Ω
Supply Voltage	: Nominal 13.8 V DC, negative ground Operating 11.7 - 15.8 V DC, negative ground
Current consumption	: 0.5 A (receive) 11 A (50 W TX, 144 MHz) 12 A (50 W TX, 430 MHz)
Operating temperature	: -4°F to $+140^{\circ}\text{F}$ (-20°C to $+60^{\circ}\text{C}$)
Case size	: Radio unit: 5.5" (W) \times 1.8" (H) \times 6.5" (D) (140 \times 45 \times 164 mm) with Front panel, w/o Fan, knob & connectors Front panel: 5.5" (W) \times 1.8" (H) \times 1.2" (D) (140 \times 45 \times 29 mm) w/o knob
Weight (approx.)	: 2.43 lbs (1.1 kg) with radio unit, Front panel, control cable

● Transmitter

RF power output	: 50/20/5 W
Modulation type	: F1D, F2D, F3E : Variable Reactance Modulation F7W : 4FSK (C4FM)
Spurious emission	: At least 60 dB below
Microphone impedance	: About 2 k Ω
DATA terminal input impedance	: About 10 k Ω

Specifications

● Receiver

Circuit type	: Double conversion super-heterodyne	
Intermediate frequencies	: 1st : 47.25 MHz, 2nd :450 kHz	
Receiver Sensitivity	: 108 - 137 MHz (AM)	0.8 μ V typ for 10 dB SN
	137 - 140 MHz (FM)	0.2 μ V for 12 dB SINAD
	140 - 150MHz (FM)	0.2 μ V for 12 dB SINAD
	150 - 174 MHz (FM)	0.25 μ V for 12 dB SINAD
	174 - 222 MHz (FM)	0.3 μ V typ for 12 dB SINAD
	222 - 300 MHz (FM)	0.25 μ V typ for 12 dB SINAD
	300 - 336 MHz (AM)	0.8 μ V typ for 10 dB SINAD
	336 - 420 MHz (FM)	0.25 μ V for 12 dB SINAD
	420 - 470 MHz (FM)	0.2 μ V typ for 12 dB SINAD
	470 - 520 MHz (FM)	0.2 μ V for 12 dB SINAD
	800 - 900 MHz (FM)	0.4 μ V typ for 12 dB SINAD
	900 - 999.99 MHz (FM)	0.8 μ V typ for 12 dB SINAD
		Cellular blocked (USA only)
	Digital mode	
	140 - 150 MHz (Digital)	0.19 μ V typ for BER 1%
	420 - 470 MHz (Digital)	0.19 μ V typ for BER 1%
Selectivity	: NFM, AM 12 kHz/30 kHz (-6 dB/-60 dB)	
AF output	: 3 W (8 Ω , THD10%, 13.8 V) internal speaker	
	8 W (4 Ω , THD10%, 13.8 V) Optional MLS-200-M10	
AF output impedance	: 4 - 16 Ω	

Cautions

- Rated values are at normal temperature and pressure.
- Ratings and specifications are subject to change without notice.

A

About internal spurious signals	168
About the antenna	23
Activating the frequency voice announcement.....	163
Activating the new pager function	87
Activating to the frequency announcement.....	164
Adjusting the date and time.....	46
Adjusting the display brightness.....	48
Adjusting the microphone sensitivity	42
Adjusting the squelch level.....	36
Adjusting the transmit power.....	42
Adjusting the volume level.....	35
All Reset.....	49
APO function	94
APRS.....	146
APRS Function.....	77
Assigning the "WX" function to a programmable key on the microphone....	60

C

Calling a specific station.....	88
Calling only the specific stations	131
CALLSIGN.....	150
Changing the 100.0 Hz CTCSS tone squelch	44
Changing the beep volume	45
Changing the call sign.....	150
Changing the frequency of the home channel.....	54
Changing the frequency steps.....	37
Changing the geodetic reference system.....	76
Changing the time zone	76
Checking the route using a personal computer	75
Checking the satellite acquisition status...	73
Checking the supplied items	13
Clearing memories	55
clone function	106
Communicating in FM mode	43
Communicating using the repeater	43
Communicating with specific stations.....	81
CONFIG	135
Connecting an external device.....	108
Connecting the antenna	27
Connecting the front panel to the main body.....	27
Connecting the microphone	27
Connecting the power supply.....	28
Connecting the transceiver.....	27
Connecting to a computer	108
Copying data from the microSD memory card	105

Copying data to a microSD memory card	104
Copying the radio data to another transceiver.....	104
Copying the saved data.....	149
Copying the transceiver settings to a microSD memory card.....	146
Creating and sending a new message....	99
CTCSS tone transmission / DCS code tone reception.....	90

D

DATA	143
DCS code transmission / CTCSS tone reception.....	90
DCS transmission.....	90
Deleting data from the content display screen.....	97
Deleting data from the list.....	98
Deleting images.....	97
Deleting messages.....	97
Deleting the registered data from the memory channels	148
DISPLAY	123
Displaying the location information.....	74
Displaying the memory tag.....	58
Downloading images.....	98
Downloading messages	98
DTMF function.....	91

E

Erasing the recorded audio	162
Exchanging images.....	96
Exchanging messages	96
Expanding the reception range	140
External speaker	115

F

Features of this transceiver.....	2
Forwarding the downloaded image data	103
Forwarding the downloaded message ...	103
Front panel.....	14

G

GM.....	134
GM Function.....	78
GPS Function	72
GPS INFO screen	20
GPS Log Function.....	74

I

Identifying the Bluetooth headset.....	155
Important precautions for mobile transceiver operation.....	3
Initializing a microSD memory card.....	146
Initializing microSD memory cards.....	33

Index

Input characters.....	20
Inputting the call sign.....	34
Inserting a microSD memory card.....	32
Installation location when used in a mobile unit.....	22
Installing the front panel.....	26
Installing the main body.....	25
Installing the transceiver.....	21

L

Limiting the continuous transmission time.....	141
Listening the weather alert.....	61
Locking the DIAL and keys.....	46

M

Main body.....	16
MEMORY.....	130
Memory scan.....	64
MH-48A6JA.....	18
Microphone.....	18
Monitoring the home channel.....	70
Mounting the Bluetooth unit "BU-2".....	151
Mounting the voice guide unit "FVS-2".....	158

N

Name and function of each component....	14
Naming a memory channel.....	56
Notification of calls from partner stations.....	131
Notification of incoming calls from partner stations using the bell function....	89

O

OPTION.....	147
Optional components.....	165

P

packet communications.....	111
pairing.....	155
Playing the recorded audio.....	162
PMS.....	68
Preparing a microSD memory card.....	31
Presetting.....	147

R

Recalling memories.....	52
Recalling the home channel.....	53
Recalling the preset setting.....	148
Recalling the weather channels.....	60
Receiving.....	34
Receiving Weather Broadcast Channels (USA version only).....	60
Recording and listening to received audio.....	158

Recording the received audio.....	161
registered DTMF code.....	92
Registering routine messages.....	101
Registering the DTMF code.....	91, 131
Registering to the memory channel.....	51
Registering to the programmable memory channels.....	68
Removing the microSD memory card.....	32
Replacing the fuse.....	166
Replying to the sender of the downloaded image data.....	102
Replying to the sender of the downloaded message.....	102
Resetting the APRS setting.....	149
Resetting the transceiver settings.....	147
Restoring defaults.....	49
Reverse tone.....	90
RST/CLONE.....	147

S

Safety Precautions.....	9
Saving location information.....	74
SCAN.....	133
Scanning.....	62
Scanning only the specified memory channels.....	67
Scanning the programmable memories.....	68
Scanning the programmable memory channels.....	69
Screen display.....	19
SD.....	146
Searching for signals.....	62
Selecting communication mode.....	39
Selecting the DCS code.....	84
Selecting the receiver operation performed after scanning stops.....	63, 134
Selecting the scanning method.....	65
Selecting the tone frequency.....	81
Sending images.....	99
Sending messages.....	99
Setting memories to skip.....	67
Setting the announcement function operation.....	163
Setting the APRS speed.....	145
Setting the beep volume.....	138
Setting the Bluetooth headset operations.....	147, 153
Setting the channel signal reception time when using the dual reception function.....	71, 134
Setting the COM port.....	143
Setting the data communication speed.....	145
Setting the date and time.....	135
Setting the DCS code.....	131

- Setting the digital mode squelch code.... 127
 - Setting the display brightness 123
 - Setting the display contrast 123
 - Setting the DTMF code transmission method 131
 - Setting the dual receive restart setting 71
 - Setting the frequency step..... 138
 - Setting the geodetic reference system... 141
 - Setting the interval for saving the GPS location information 142
 - Setting the memory scan method..... 130
 - Setting the memory tag display 130
 - Setting the microcomputer clock shift.... 138
 - Setting the microphone sensitivity..... 125
 - Setting the modulation mode..... 125
 - Setting the packet communication operation 112
 - Setting the PIN code for the Bluetooth headset..... 141
 - Setting the program keys on the microphone..... 138
 - Setting the repeater shift direction..... 137
 - Setting the repeater shift width..... 137
 - Setting the scanning direction 133
 - Setting the signal reception method 133
 - Setting the squelch type 131
 - Setting the squelch type in digital mode 126
 - Setting the squelch type separately for transmission and reception 132
 - Setting the time display format..... 135
 - Setting the time to display the partner station information in a pop-up window.. 128
 - Setting the time zone..... 136
 - Setting the tone frequency 131
 - Setting the transceiver pager code..... 86
 - Setting the transmission mode when using the AMS function..... 125
 - Setting the unit displayed on the screen..... 140
 - Setting the voice memory operation..... 160
 - Setting the voice memory operations..... 147
 - Setting the weather alert operation (USA Version Only) 132
 - Setting up the screen display 123
 - Setting your location information display 128
 - Setup menu basic operations..... 116
 - Setup-menu listing..... 117
 - SIGNALING..... 131
 - Sorting the memory channels..... 149
 - Sounding a beep when a partner station ends a transmission..... 129
 - Specifications 169
 - Specifying memory channels 66
 - Split memory 59
 - Squelch detection and squelch jack output settings..... 146
 - Switching the GPS information..... 124
 - Switching the modulation mode 40
 - Switching the operation mode..... 38
 - Switching the power off 34
- T**
- The keys or knobs do not operate..... 167
 - There is no power..... 167
 - There is no sound..... 167
 - There is no transmission 167
 - timer function..... 94
 - Toggling the operating band..... 35
 - tone squelch function 81
 - TOT function..... 95
 - Transmitting..... 41
 - Transmitting GPS location information... 109
 - Transmitting the DTMF code manually 92
 - Transmitting tone signals 83
 - Troubleshooting..... 167
 - Tuning in to the frequency..... 37
 - Turning off the transceiver automatically 141
 - Turning the power on 34
 - TX/RX..... 125
- U**
- Updating the transceiver firmware..... 110
 - User Programmed Reverse CTCSS Decoder..... 90
 - Using routine message..... 100
 - Using the auto repeater shift function.... 136
 - Using the Bluetooth headset..... 151, 157
 - Using the DCS function 85
 - Using the digital code squelch function 84
 - Using the dual receive function 70
 - Using the half deviation function 130
 - Using the Memory 51
 - Using the new pager function..... 86
 - Using the tone squelch function 82
 - Using the voice memory..... 160
- V**
- Viewing the image list..... 96
 - Viewing the message list..... 96
 - VFO scan 62
- W**
- WIRES-X..... 134
 - WIRES-X Function 80

1. Changes or modifications to this device not expressly approved by YAESU MUSEN could void the user's authorization to operate this device.
2. This device complies with part 15 of the FCC Rules. Operation is subject to the following two conditions: (1) This device may not cause harmful interference, and (2) this device must accept any interference including received, interference that may cause undesired operation.
3. The scanning receiver in this equipment is incapable of tuning, or readily being altered, by the User to operate within the frequency bands allocated to the Domestic public Cellular Telecommunications Service in Part 22.

This device complies with Industry Canada license-exempt RSS standard(s). Operation is subject to the following two conditions: (1) this device may not cause interference, and (2) this device must accept any interference, including interference that may cause undesired operation of the device.

Le présent appareil est conforme aux CNR d'Industrie Canada applicables aux appareils radio exempts de licence. L'exploitation est autorisée aux deux conditions suivantes : (1) l'appareil ne doit pas produire de brouillage, et (2) l'utilisateur de l'appareil doit accepter tout brouillage radioélectrique subi, même si le brouillage est susceptible d'en compromettre le fonctionnement.

DECLARATION BY MANUFACTURER

The Scanner receiver is not a digital scanner and is incapable of being converted or modified to a digital scanner receiver by any user.

WARNING: MODIFICATION OF THIS DEVICE TO RECEIVE CELLULAR RADIOTELEPHONE SERVICE SIGNALS IS PROHIBITED UNDER FCC RULES AND FEDERAL LAW.

YAESU

The radio

YAESU MUSEN CO., LTD.

Tennozu Parkside Building
2-5-8 Higashi-Shinagawa, Shinagawa-ku, Tokyo
140-0002 Japan

YAESU USA

6125 Phyllis Drive, Cypress, CA 90630, U.S.A.

YAESU UK

Unit 12, Sun Valley Business Park, Winnall Close
Winchester, Hampshire, SO23 0LB, U.K.

Copyright 2015
YAESU MUSEN CO., LTD.
All rights reserved.
No portion of this manual
may be reproduced
without the permission of
YAESU MUSEN CO., LTD.

Printed in Japan
1506F-AO

