

YAESU

The radio

AIR BAND TRANSCEIVER

FTA-230

Operating Manual

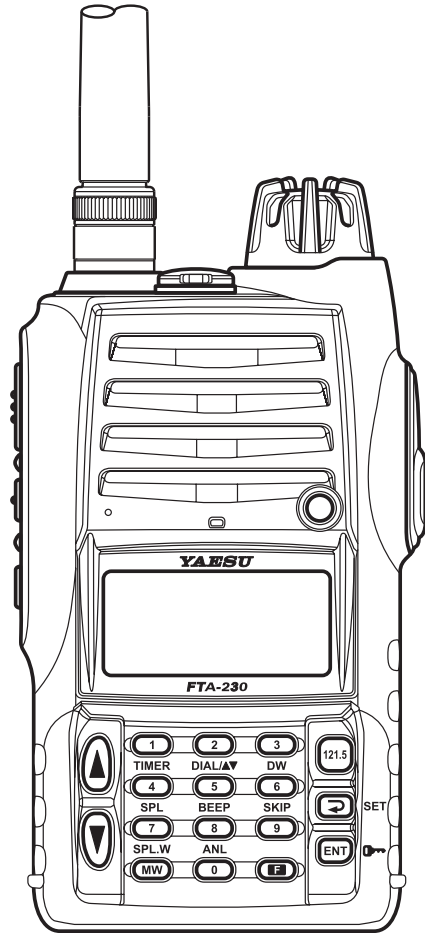

CONTENTS

Important Notice!	1	Advanced Operation	18
Introduction	2	Tuning Methods.....	18
Accessories & Options	3	Reception of Weather Channel Broadcasts.....	19
Control & Connectors	5	Monitor Key	20
Top Panel	5	ANL (Automatic Noise Limiter) Feature	20
Front Panel.....	6	LOCK Function	21
Side Panel	7	DIAL and [▼]/[▲] key Swap Configuration.....	21
Keypad.....	8	Receive Battery Saver Setup	22
LCD Display.....	9	Beep On/Off.....	23
Before You Begin	10	Changing the Channel Steps.....	24
Precautions.....	10	VOX Operation.....	25
Battery Installation and Removal	10	Side Tone Feature	26
Battery Charging.....	11	Timer Operation.....	27
Low Battery Indication.....	12	Memory Operation	28
Installing the FBA-25A Alkaline Battery Case	13	Memory System Operation.....	28
Basic Operation	14	Memory Storage	28
Preliminary Steps.....	14	Recalling the Memories.....	30
Operation Quick Start.....	14	Deleting Memories	31
Squelch Adjustment.....	16	Scanning Operation	32
Accessing the 121.5 MHz Emergency Frequency.....	16	Channel-Skip Scanning	33
Transmission.....	16	Dual Watch Operation	34
Flip-Flop Feature (Frequency Recall)	17	Priority Dual Watch Operation	35
		Split Operation	36
		Programming a Transmit Frequency	36
		Operating in the Split Mode	37
		Field Programming Mode	38
		CPU Resetting	39
		Menu (“Set”) Mode	40
		Specifications	46
		Troubleshooting	48
		Book Memory Channel List	49

NOTICE

There are no user-serviceable parts inside this transceiver. All service jobs must be referred to your Authorized Service Center.

IMPORTANT NOTICE!

FCC RF Exposure Compliance Requirements for Occupational Use Only:

This **FTA-230** has been tested and complies with the Federal Communications Commission (FCC) RF exposure limits for Occupational Use/Controlled Exposure Environment. In addition, it complies with the following Standards and Guidelines:

- ❑ FCC 96-326, Guidelines for Evaluating the Environmental Effects of Radio-Frequency Radiation.
- ❑ FCC OET Bulletin 65 Edition 97-01 (1997) Supplement C, Evaluating Compliance with FCC Guidelines for Human Exposure to Radio Frequency Electromagnetic Fields.
- ❑ ANSI/IEEE C95.1-1992, IEEE Standard for Safety Levels with Respect to Human Exposure to Radio Frequency Electromagnetic Fields, 3 kHz to 300 GHz.
- ❑ ANSI/IEEE C95.3-1992, IEEE Recommended Practice for the Measurement of Potentially Hazardous Electromagnetic Fields - RF and Microwave.
- When transmitting, hold the radio in a vertical position with its microphone 1 to 2 inches (2.5 to 5 cm) away from your mouth and keep the antenna at least 1 inch (2.5 cm) away from your head and body.
- The radio must be used with a maximum operating duty cycle not exceeding 50%, in typical Push-to-Talk configurations. DO NOT transmit for more than 50% of total radio use time (50% duty cycle). Transmitting more than 50% of the time can cause FCC RF exposure compliance requirements to be exceeded. The radio is transmitting when the red LED on the front panel of the radio is illuminated. You can cause the radio to transmit by pressing the P-T-T button.
- Always use Yaesu authorized accessories.

INTRODUCTION

The YAESU **FTA-230** is a compact, stylish, solid, submersible (IP7: 3 ft for 30 minutes) hand-held transceiver providing communication (transmit and receive) capability on the International Aircraft Communication Band (“COM” band: 118 ~ 136.975 MHz), and it additionally provides receive on the “NAV” band (108 ~ 117.975 MHz).

The **FTA-230** boasts 0.7 Watt of clean audio output from its 1.4” (36-mm) diameter loudspeaker, and it also provides 8.33 kHz synthesizer steps for the new narrow-band channel plan.

The **FTA-230** displays with our exclusive Omni-Glow™ display back-lighting for minimal degradation of your night vision, NOAA weather band monitoring, 8-character Alpha/Numeric Display, 150 Memory Channels, and 100 “Book Memory” Channels.

We recommend that you read this manual in its entirety, so as to understand the many features of the **FTA-230** completely. Keep this manual handy, so you may use it for reference.

Congratulations!

You now have at your fingertips a valuable communications tool, a YAESU two-way radio! Rugged, reliable and easy to use, your YAESU radio will keep you in constant touch with your friends and colleagues for years to come, with negligible maintenance or down-time.

Please take a few minutes to read this manual carefully. The information presented here will allow you to derive maximum performance from your radio, in case questions arise later on.

We’re glad you joined the YAESU team. YAESU products cover the entire spectrum of radio communications applications, and our worldwide support network is here to serve you. Let us help you get your message across.

ACCESSORIES & OPTIONS

Supplied Accessories

Ni-MH Battery Pack (7.2V)	FNB-83
100-240 VAC Wall Charger	PA-48B/C *
100-240 VAC Charging Cradle	CD-32
12 V DC Charging Cradle	CD-59
Helical Antenna	YHA-73
Headset Cable	CT-96
Alkaline Battery Case	FBA-25A
Operating Manual	
Warranty Card	

*: “**B**” suffix is for use with 120 VAC or “**C**” suffix is for use with 230-240 VAC.

Available Options

YHA-73	Helical Antenna
MH-44B4B	Speaker Microphone
FBA-25A	Alkaline Battery Case
FNB-83	Ni-MH Battery Pack (7.2V)
CD-32	Charger Cradle
E-DC-5B	DC Cable w/Noise
E-DC-6	DC Cable; plug and wire only
CT-96	Headset Cable

Availability of accessories may vary. Some accessories are supplied as standard per local requirements, while others may be unavailable in some regions. Consult your YAESU Dealer for details regarding these and any newly available options.

Connection of any non-YAESU-approved accessory, should it cause damage, may void the Limited Warranty on this apparatus.

ACCESSORIES & OPTIONS

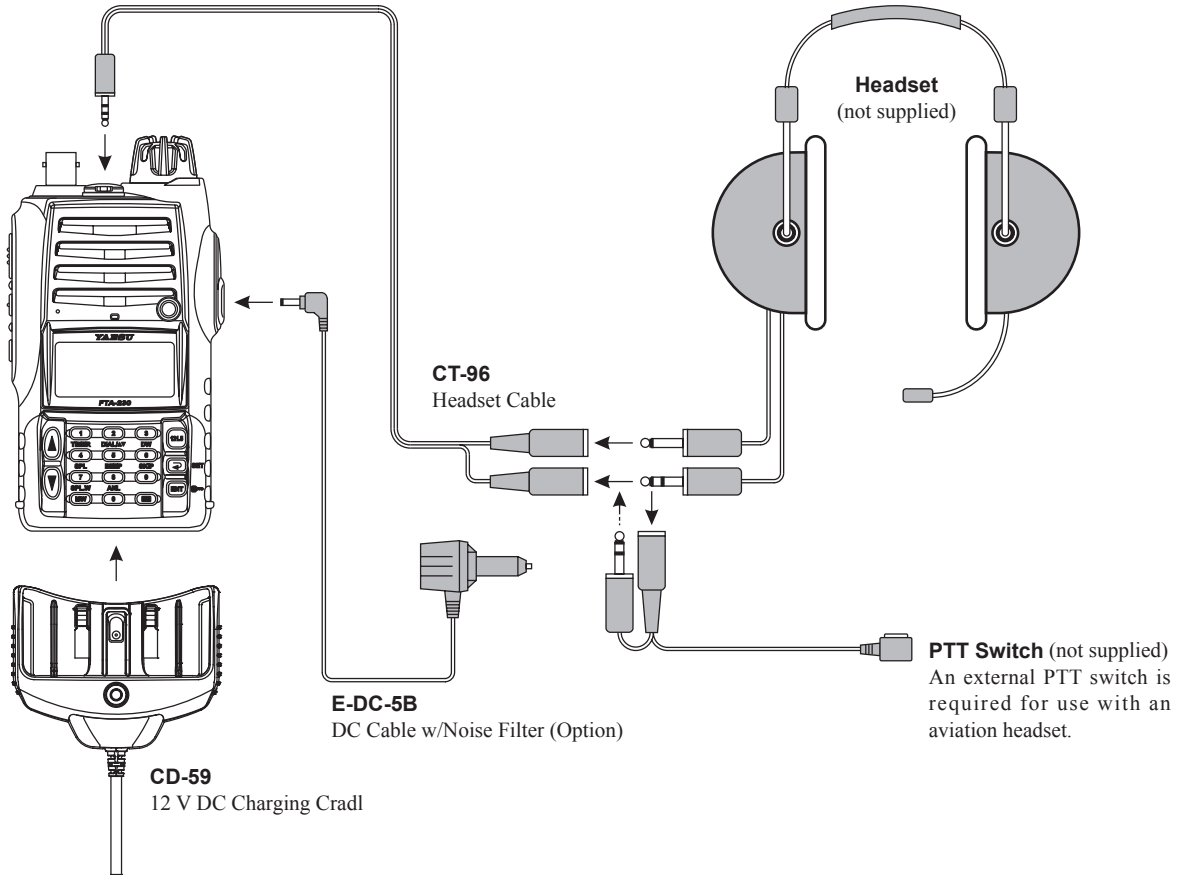

CONTROLS & CONNECTORS (TOP PANEL)

① Antenna Jack

This BNC connector jack accepts the supplied flexible antenna, or another antenna designed to provide 50 Ohm impedance on the Aircraft Communication Band.

② MIC/EAR Jack

You may connect the supplied **CT-96** Headset Cable or the (optional) **MH-44B4B** Speaker/Microphone to this jack.



1) Never connect any Speaker/Microphone that is not recommended by the manufacturer. Because these jack connections are unique, using a Speaker/Microphone that is not specified by Yaesu may damage the FTA-230.

2) Do not allow the FTA-230 to become submerged in water while the rubber cap over the MIC/EAR jack is removed.

③ DIAL Selector Knob

This (outer) 20-position detented rotary switch tunes the operating frequency or selects the memory channels.

This rotary switch also adjusts the audio volume level by the setting of the Secondary function of the [5(DIAL/▼▲)] key. See page 21 for details.

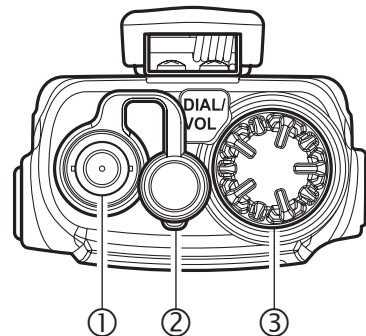

CONTROLS & CONNECTORS (FRONT PANEL)

① **Loudspeaker**

The internal speaker is located in this position.

② **Microphone**

Speak across this opening in a normal voice level, while pressing the PTT switch, to transmit.

③ **LCD (Liquid Crystal Display)**

The display shows selected operating conditions, as indicated on page 9.

④ **Keypad**

The keypad is used for most radio command operations. Several keys have triple functions.

The primary functions are activated by simply pressing the key momentarily.

The secondary functions are activated by pressing the [F] key followed by the key.

The third functions are activated by pressing and holding in the key for 2 seconds.

These functions are described in detail on page 8.

⑤ **BUSY/TX Indicator Lamp**

This lamp glows green when a signal is being received, and red when transmitting.

⑥ **Battery Pack Latch**

Open this latch for battery removal.

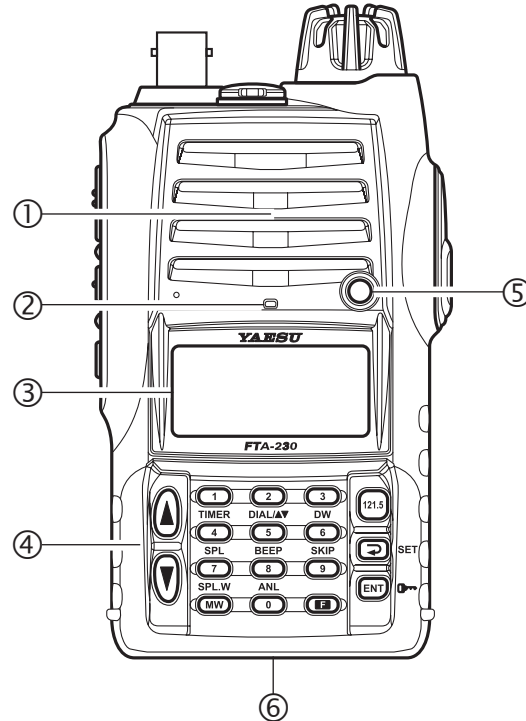

CONTROLS & CONNECTORS (SIDE PANEL)

① PTT (Push To Talk) Switch

Press this button to transmit when you are operating in the COM band. Release this button to return to the “Receive” mode. See page 16 for details.

② MONITOR Switch

This button may be pressed to “open” the squelch manually, allowing you to listen for very weak signals. Press and hold this button for 2 seconds to “open” the squelch continuously. Press this button again to resume normal (quiet) monitoring. See page 20 for details.

③ POWER Switch

Press and hold this button for 3 seconds to toggle the transceiver’s power on and off.

④ EXT DC Jack

When an external 12-Volt DC power source is available, you may connect the (optional) **E-DC-5B** External DC Cable here.







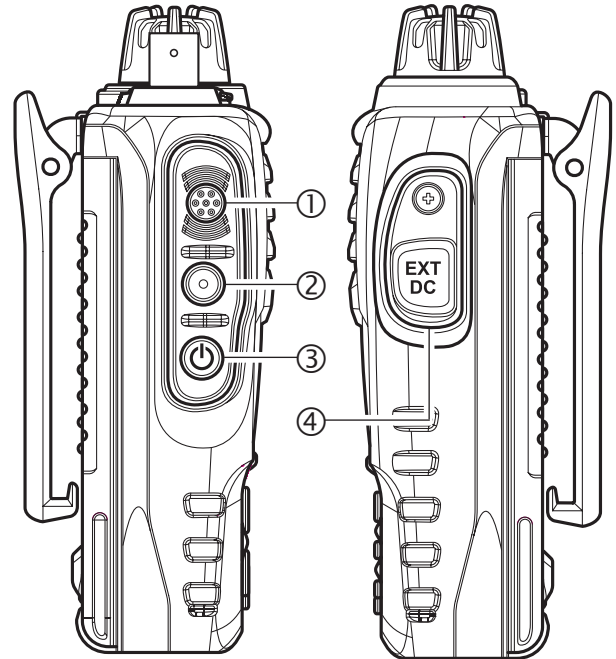











1) Do not connect any wire to this jack if that wire is connected directly to a 28-Volt DC source. Connecting the FTA-230 directly to a source which exceeds 15.0 Volts DC will result in damage to the unit, and this type of damage is not covered by the Limited warranty on this product.

2) Do not allow the FTA-230 to become submerged in water while the rubber cap over the EXT DC jack is removed.



CONTROLS & CONNECTORS (KEYPAD)

				
Primary Function (Press Key)	Frequency Entry Digit 1	Frequency Entry Digit 2	Frequency Entry Digit 3	Selects Emergency Channel (121.5 MHz).
Secondary Function (Press [F] + key)	None	None	None	None
Third Function (Press and Hold key)	None	None	None	None
				
Primary Function (Press Key)	Frequency Entry Digit 4	Frequency Entry Digit 5	Frequency Entry Digit 6	1) Selects the Memory Display Type 2) Switches between VFO mode and Flip-Flop display
Secondary Function (Press [F] + key)	Activates the Stop Watch Timer	Exchange the functions of the DIAL and [▼]/[▲] keys	Activates the Dual Watch Feature	Activates the Set (Menu) Mode
Third Function (Press and Hold key)	None	None	Activates the VOX Feature	Activates the Scanner
				
Primary Function (Press Key)	Frequency Entry Digit 7	Frequency Entry Digit 8	Frequency Entry Digit 9	Select the tuning methods among the VFO, MR, BMR, and WX
Secondary Function (Press [F] + key)	Activates Split (Duplex) mode.	Enable/Disable the Keypad Beeper	Allows Skipping of Channel during Scan	Activates the Key Lockout Feature
Third Function (Press and Hold key)	None	None	None	None
				
Primary Function (Press Key)	None	Frequency Entry Digit 0	Activates "Secondary" key mode.	Increase the audio level or select the operating channel* [ⓧ]
Secondary Function (Press [F] + key)	Split-Memory "Write" Command	Adjusts the Automatic Noise Limiter	Cancel the "Secondary" key mode of the [F] key.	Decrease the audio level or select the operating channel* [ⓧ]
Third Function (Press and Hold key)	Memory "Write" Command	None	None	

*: Depends on setting of the Secondary function of the  key. See page 18 for details.

CONTROLS & CONNECTORS (LCD DISPLAY)

These digits provide frequency or alpha-numeric information about the channel you are using.

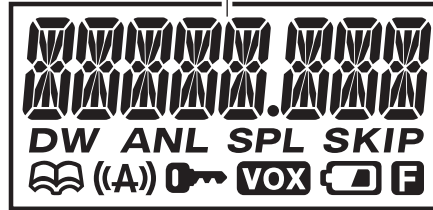

DW

This indicator confirms that “Dual Watch” is active. See page 34.

ANL

This indicator confirms that “Automatic Noise Limiter” is active. See page 20.

SPL

This indicator confirms that “Split” (Duplex) mode is activated. See page 38.

SKIP

This indicator confirms that this channel will be skipped during scan. See page 35.



This icon indicates that the “Book” Memory Bank is in use. See page 18.



This icon indicates that the “Weather Alert” feature is active. See page 45.



This indicator confirms that the Key Lock is activated. See page 21.



This indicator confirms that “VOX” system is active. See page 25.



This icon is the “Low Battery” indicator, which blinks when the battery voltage becomes too low for proper operation.



This indicator confirms that **Secondary** Key Function is active. See page 8.

BEFORE YOU BEGIN

Precautions

- The **FTA-230** is apparatus is capable of two-way communication on channels used for critical aviation safety communications. Therefore, it is important that this radio be kept away from children or other unauthorized users at all times.
- When making DC connections via the (optional) **E-DC-5B** DC cable, be absolutely certain to observe the proper voltage level and polarity guidelines. Do not connect this radio directly to any 24 ~ 28 Volt DC source, nor to AC power of any kind. Connecting the **FTA-230** directly to a source which exceeds 15.0 Volts DC will result in damage to the unit. The Limited Warranty for this product does not cover damage caused by the application of improper voltage.
- Do not dispose of the Ni-MH Battery Pack in a fire. Do not carry a Ni-MH Battery Pack in your pocket, where keys or coins could short the terminals. This could create a serious fire/burn danger, and possibly cause damage to the Ni-MH pack.
- Although the **FTA-230** is designed to be Submersible (3 ft., 30 min.), its enclosure is not designed to guarantee protection from ingress of water under extreme pressure. Do not allow the radio to become submerged in deep water, and do not subject it to water spray under pressure.

Battery Installation and Removal

- To install the battery, hold the transceiver with your left hand, so your palm is over the speaker and your thumb is on the top of the Belt Clip. Insert the battery pack into the battery compartment on the back of the radio while tilting the Belt Clip outward, then close the Battery Pack Latch until it locks in place with a “Click.”

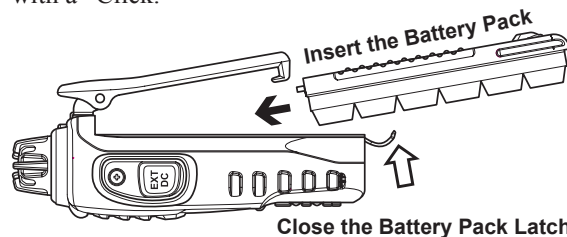

- To remove the battery, turn the radio off and remove any protective cases. Open the Battery Pack Latch on the bottom of the radio, then slide the battery downward and out from the radio while unfolding the Belt Clip.



Do not attempt to open any of the rechargeable Ni-MH packs, as personal injury or damage to the Ni-MH pack could occur if a cell or cells become accidentally short-circuited.

BEFORE YOU BEGIN

Battery Charging

It is necessary to charge the Ni-MH battery fully before its first use. Follow these procedures:

- ❑ Install the supplied **FNB-83** Ni-MH battery pack onto the transceiver. Ensure that the transceiver is switched off.

Use for PA-48/CD-32

1. Insert the cable plug into the jack located on the right side of the **CD-32** Charging Cradle then plug the **PA-48** Battery Charger into the AC line outlet.
2. Insert the transceiver and battery pack into the **CD-32**; the antenna jack should be at the left side when viewing the charger from the front.
3. If the transceiver and battery pack are inserted correctly, the RED indicator on the **CD-32** will glow. A fully-discharged pack will be charged completely in 12 hours.

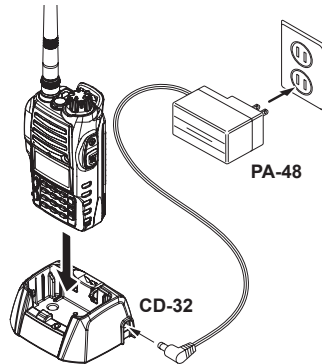

Use for CD-59

1. Insert the cigarette lighter plug into the cigarette lighter socket (DC 11 V ~ 16 V).
2. Insert the transceiver and battery pack into the **CD-59**; the antenna jack should be at the left side when viewing the charger from the front.
3. If the transceiver and battery pack are inserted correctly, the RED indicator on the **CD-59** will glow. A fully-discharged pack will be charged completely in 15 hours.

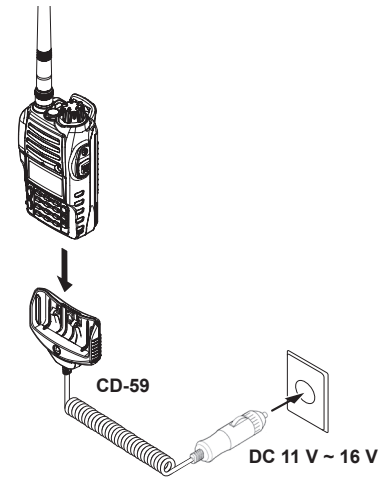



BEFORE YOU BEGIN

Important Notes:

- The **PA-48** is not designed to power the transceiver for operation (reception or transmission).
- Do not leave the charger connected to the transceiver for continuous periods in excess of 24 hours. Long term overcharging can degrade the Ni-MH battery pack and significantly shorten its useful life.
- If using a charger other than the **PA-48/CD-32**, **CD-59**, or if using a battery pack other than the **FNB-83**, follow the appropriate instructions provided with the charger/battery. Contact your Dealer if you have any doubts about the appropriateness of the particular charger or battery pack you intend to use.

Low Battery Indication

- As your battery discharges during use, the voltage will gradually become lower. When the battery voltage is becoming too low for reliable operation, the “The image shows a rectangular LCD display. On the left side, there is a vertical scale with a 'V' at the top. In the center, the number '13.900' is displayed in a large, digital font. Below the number, there is a small battery icon with a vertical line through it, indicating a low battery level. The entire display is enclosed in a thin black border.

BEFORE YOU BEGIN

Installing the FBA-25A Alkaline Battery Case

The supplied **FBA-25A** Battery Case allows operation of the **FTA-230** using six “AA” size Alkaline batteries.

When installing batteries, insert the (–) end first, then press in the (+) end so the battery snaps into place. Always replace all six batteries at the same time, paying attention to the polarity indicated inside the case.



The FBA-25A must not be used with re-chargeable cells. The FBA-25A does not contain the thermal and over-current protection circuits (provided in the “FNB” series of Ni-MH Battery Packs) required when utilizing Ni-Cd and Ni-MH cells.

BASIC OPERATION

Preliminary Steps

- Install a charged battery pack onto the transceiver, as described previously.
- Twist the supplied antenna onto the Antenna jack. Never operate this transceiver without an antenna connected.
- If you have an optional Speaker/Microphone or headset, we recommend that it not be connected until you are familiar with the basic operation of the **FTA-230**.

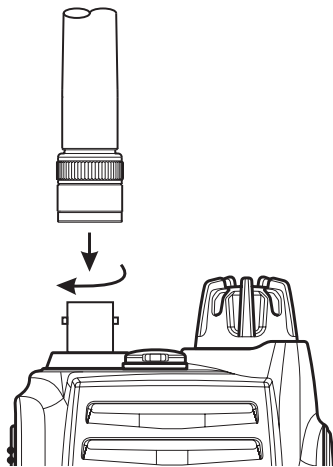

Operation Quick Start

- To turn the radio on, press and hold in the **[POWER]** Switch of for 3 seconds.

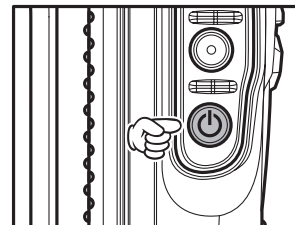

- A channel frequency should appear on the display. If not, press the **[ENT (0↔)]** key (repeatedly, if necessary) so that “- VFO -” appears on the display, followed by a channel frequency.

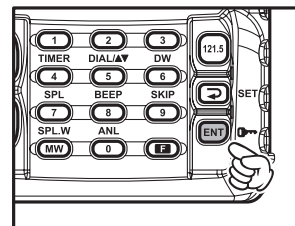

- Directly entering frequencies from the keypad is the easiest method if you know the frequency on which you wish to operate. Just enter the five digits of the frequency to move to that frequency. However, there is a short-cut for frequencies ending in zero - press the **[↔(SET)]** key after the last non-zero digits. For example, to set 134.35 MHz, Press **[1] → [3] → [4] → [3] → [5]**. To set 118.00 MHz: Press **[1] → [1] → [8] → [↔(SET)]**.

BASIC OPERATION

To set 118.275 MHz, you do not need to press the final “5” in the frequency:

[1] → [1] → [8] → [2] → [7].

- ❑ You may also turn the top panel’s **DIAL** selector knob^{※1} to choose the desired operating frequency. The channel frequency will appear on the LCD.
- ❑ Press the [▼]/[▲] key^{※2} to set the volume level. If no signal is present, press and hold the [**MONITOR**] button for 2 seconds; background noise will now be heard, and you may use this noise to set the desired audio level. Press the [**MONITOR**] button momentarily to silence the noise and resume normal (quiet) monitoring.

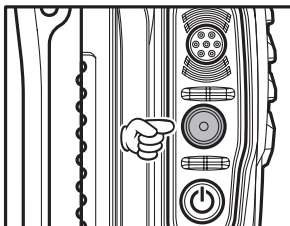
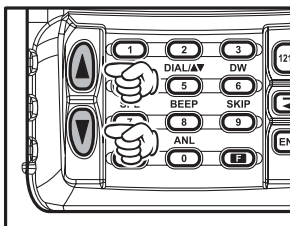
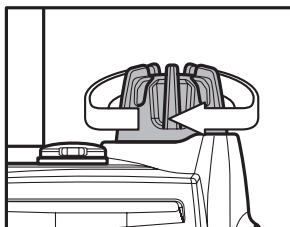

※1: If you change the function of **DIAL** and [▼]/[▲] key by pressing the [F] key followed by the [5(DIAL/▼▲)] key, you may choose the operating frequency by pressing the [▼]/[▲] key.

※2: If you change the function of **DIAL** and [▼]/[▲] key by pressing the [F] key followed by the [5(DIAL/▼▲)] key, you may set the volume level by turning the **DIAL** selector knob.

- ❑ To turn the radio off, press and hold in the [**POWER**] switch for 3 seconds.

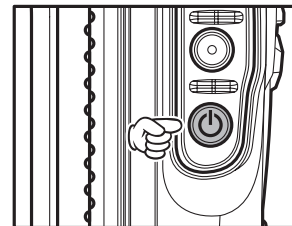

BASIC OPERATION

Squelch Adjustment

- ❑ Press the [F] key momentarily, then press the [↩] (SET) key to activate the Menu (SET) mode.
- ❑ Rotate the **DIAL** selector knob to select Menu Item “SQL.”
- ❑ Press the [ENT(🔑)] key to enable adjustment of this Menu item.
- ❑ Rotate the **DIAL** selector knob to set the squelch threshold (0 to 8) so that the receiver is just silenced. A higher number indicates that a higher signal level is required in order to open the squelch.
- ❑ Press the [ENT(🔑)] key to save your new setting.
- ❑ Press the **PTT** switch to exit the Menu (“SET”) mode.

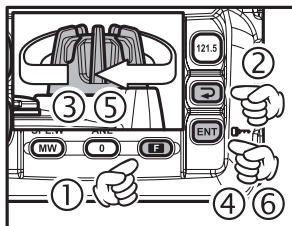

Accessing the 121.5 MHz Emergency Frequency

The **FTA-230** can quickly access the 121.500 MHz Emergency Frequency. This function can be activated even when the keypad lock function (described on page 21) is in use.

- ❑ To access the Emergency Frequency, press the [121.5] key momentarily.
- ❑ To exit the Emergency Frequency, press the [ENT(🔑)] key.

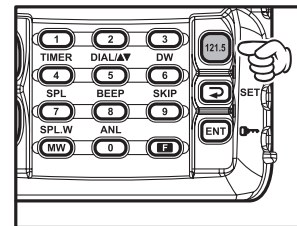

Transmission

- ❑ To transmit, press and hold the **PTT** switch. Speak into the microphone area of the front panel grille in a normal voice level.
- ❑ To return to the receive mode, release the **PTT** switch.

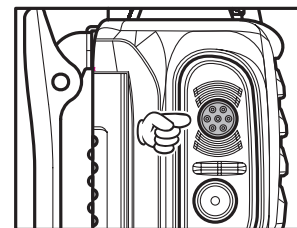

ADVANCED OPERATION

Tuning Methods

Throughout this manual, you will see references to several different frequency setting methods. Each will be particularly useful in a particular operating situation, and they are described below:

○ VFO (Variable Frequency Oscillator)

The VFO is a “tuning dial” system which allows you to tune through the NAV or COM bands using the **DIAL** selector knob, the Keypad, or the scanner.

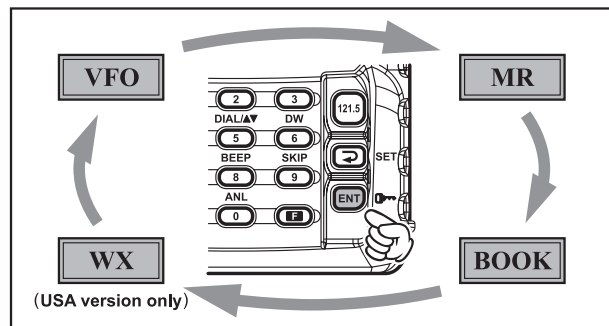

○ MR (Memory Recall)

The MR (Memory Recall) mode of the **FTA-230** provides the user with the ability to store and recall as many as 150 channels in the radio's main memory bank. These memory channels may also be labeled by you with an alpha/numeric name of up to 8 characters in length, to aid in quick identification of the channel. See page 28 for details on creating alpha/numeric labels.

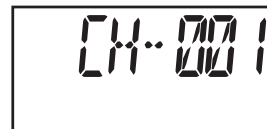

○ BOOK (Pre-Programmed) Memories

The Book memories are pre-programmed, either at the factory or by your Dealer (depending on your country's requirements), typically including the major COM and NAV band station frequencies used in your area. The Book memories can be changed by the user. See page 38 for details.



○ WX (Weather Channel) Memories (USA version only)

Ten Weather Channels are pre-programmed at the factory. The **FTA-230** will automatically scan this special bank when it is selected by the user.

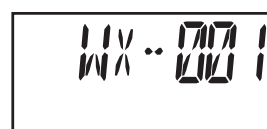

ADVANCED OPERATION

Reception of Weather Channel Broadcasts (USA version only)

The **FTA-230** can receive VHF Weather Channel broadcasts, which may assist your flight planning. The **FTA-230** includes a ten-channel auto-search feature, which simplifies access to Weather Channels when you are in an unfamiliar location.

- ❑ To receive Weather Channels, press the [ENT(↔)] key (repeatedly, if necessary) to select the Weather Channel mode. In the Weather Channel mode, “- WX -” will appear on the display.

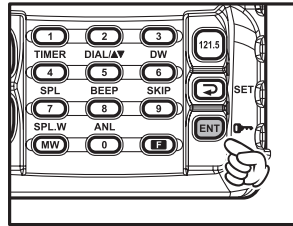

- ❑ The **FTA-230** will now scan quickly through the ten standard Weather Channels, and will stop on the first active station found.
- ❑ If there are two or more weather channels audible in your area, you may select the alternate channel(s) by pressing the **PTT** switch. Pressing the **PTT** switch re-initiates the scanning process.

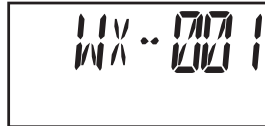

- ❑ If there are no Weather Channels in your area, the scanner will not stop. Press the [MONITOR] button to stop the scanner.
 - ❑ You can also select Weather Channels manually by rotating the **DIAL** selector knob*.
 - ❑ To confirm the current Weather Channel frequency, press the [↔(SET)] key momentarily. The display changes to frequency indication. Press the [↔(SET)] key again to return to normal display.
 - ❑ To exit the Weather Channel mode, press the [ENT(↔)] key momentarily to return to the VFO mode.
- *: If you change the function of **DIAL** and [▼]/[▲] key by pressing the [F] key followed by the [5(DIAL/▼▲)] key, you may select Weather Channels by pressing the [▼]/[▲] key.



Note 1: In the event of extreme weather disturbances, such as storms and hurricanes, the NOAA (National Oceanic and Atmospheric Administration) sends a weather alert accompanied by a 1050 Hz tone and subsequent weather report on one of the NOAA weather channels. You may setup the Alert function when receiving the

ADVANCED OPERATION

Weather Alert signal via Menu Item “WXAF,” if desired. See page 45 for details.

Note 2: The Weather Channel mode memorizes the last Weather Channel you have used, and will retain this information until the radio is turned off.

Monitor Key

When listening to a very weak signal from an aircraft or ground station, you may observe the signal disappearing periodically as the incoming signal strength becomes too weak to override the squelch threshold setting.

To disable the squelch temporarily, press and hold the [MONITOR] key for 2 seconds on the left side of the radio, just below the PTT button. The squelch will remain open and you should have a better chance of hearing weak signals.

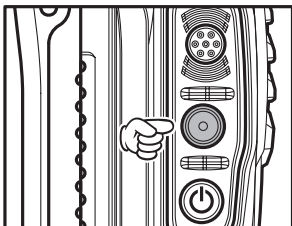

To return to normal operation, press the [MONITOR] key momentarily.

ANL (Automatic Noise Limiter) Feature

For reduction of impulse noise, such as that produced by an engine’s ignition system, the ANL feature may prove helpful.

- ❑ To activate the ANL feature, press the [F] key followed by the [0(ANL)] key. The “ANL” icon will appear on the display, and you should observe a reduction in the ignition noise.

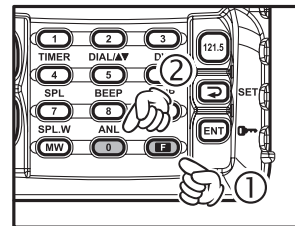





- ❑ To turn the ANL feature off, repeat the above step (press the [F] key followed by the [0(ANL)] key); the “ANL” icon will disappear from the display.



ADVANCED OPERATION

LOCK Function

The lock function prevents accidental changes to the frequency setting and the keypad controls.

- ❑ To activate the lock feature, press the [F] key followed by the [ENT()] key. The “” icon will appear on the display
- ❑ To turn the lock feature off, repeat the above step (press the [F] key followed by the [ENT()] key); the “” icon will disappear from the display.
- ❑ You can still access the 121.500 MHz Emergency Frequency when the LOCK function is on. Simply press the [121.5] key momentarily (this key *never* locks). Pressing this key also unlocks the radio.

You may choose the lockout configuration according to your operating preferences. See page 45 for details.

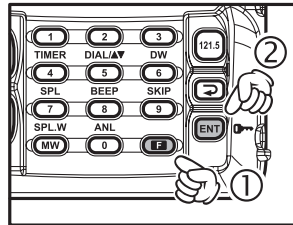

DIAL and [▼]/[▲] key Swap Configuration

In the factory default, the **DIAL** selector knob selects the operating frequency and the memory channel, and the [▼]/[▲] key adjust the audio volume level. However, you may exchange the function of the **DIAL** selector knob and [▼]/[▲] key; as a result, adjust the audio volume level by the **DIAL** selector knob, and selects the operating frequency and the memory channel by the [▼]/[▲] key.

Press the [F] key followed by the [5(DIAL/▼▲)] key to toggle the **DIAL** and [▼]/[▲] key configurations.

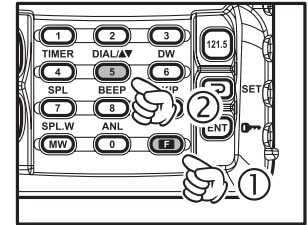

ADVANCED OPERATION

Receive Battery Saver Setup

An important feature of the **FTA-230** is its Receive Battery Saver, which “puts the radio to sleep” for a time interval, periodically “waking it up” to check for activity. If somebody is talking on the channel, the **FTA-230** will remain in the “active” mode, then resume its “sleep” cycles. This feature significantly reduces quiescent battery drain, and you may change the amount of “sleep” time between activity checks using the Menu System:

- ❑ Press the [F] key momentarily, then press the [↩(SET)] key to activate the Menu (“SET”) mode.
- ❑ Rotate the **DIAL** selector knob to select Menu Item “RSAV.”
- ❑ Press the [ENT(↵)] key to enable adjustment of this Menu Item.
- ❑ Rotate the **DIAL** selector knob to select the desired “duty cycle” (receive:sleep). The selections available are 1:1, 1:2, 1:3, 1:4, 1:5, and ABS* or OFF. The default value is 1:1.

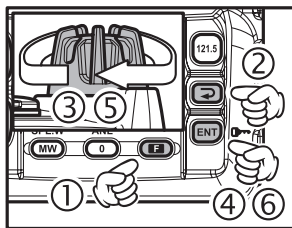

- ❑ When you have made your selection, press the [ENT(↵)] key to save the new setting, and then press the PTT key to exit to normal operation.

※: ABS: Automatic Battery Saver, based on activity on the receiver.

The setting of 1:5 will promote the greatest conservation of battery capacity, but the receiver’s response time to incoming calls will be slowed somewhat.

Note: This feature does not operate during Scan or Dual Watch.

ADVANCED OPERATION

Beep On/Off

The **FTA-230**'s key/button beeper provides convenient audible feedback whenever a button is pressed. Each key and button has a different beep pitch, and each function has a unique beep combination.

When you are scanning, the beeper will be heard each time the scanner halts on a busy channel. This may be distracting in some environments; if you want to turn the beeper off (or back on again):

- To disable the beeper, press the [F] key followed by the [8(BEEP)] key. The “**BEEP OFF**” notation will appear on the display for 3 seconds.
- To turn the beep on, repeat the above step (press the [F] key followed by the [8(BEEP)] key); the “**BEEP ON-**” notation will appear on the display for 3 seconds.

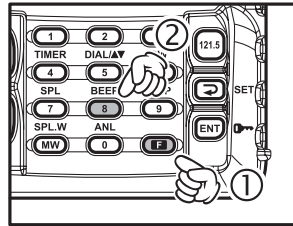

The **FTA-230** provides for adjustment of the Beep level via the Menu. To adjust the Beep level:

- Press the [F] key momentarily, then press the [↩(SET)] key to activate the Menu (“SET”) mode.
- Rotate the **DIAL** selector knob to select Menu Item “**BPLV**.”
- Press the [ENT(↵)] key to enable adjustment of this Menu item.
- Rotate the **DIAL** selector knob to select the desired beep level (1, 2, or 3).
- When you have made your selection, press the [ENT(↵)] key to save the new setting, and then press the **PTT** key to exit to normal operation.

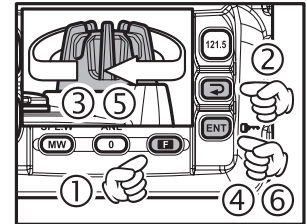

You may turn the beeper on and off via the Menu Item “**BEEP**.”

ADVANCED OPERATION

Changing the Channel Steps

The **FTA-230**'s synthesizer provides the option of utilizing channel steps of 8.33/25 kHz per step (default: 25 kHz). If you need to change the channel step size, the procedure to do so is very easy.

- ❑ First set the **FTA-230** to the operating band (NAV or COM) on which you wish to change the channel steps.
- ❑ Press the [F] key momentarily, then press the [↩(SET)] key to activate the Menu ("SET") mode.
- ❑ Rotate the **DIAL** selector knob to select Menu Item "**STEP**."
- ❑ Press the [ENT(↩)] key to enable adjustment of this Menu item.
- ❑ Rotate the **DIAL** selector knob to select the new channel step size.
- ❑ When you have made your selection, press the [ENT(↩)] key to save the new setting, and then press the **PTT** key to exit to normal operation.

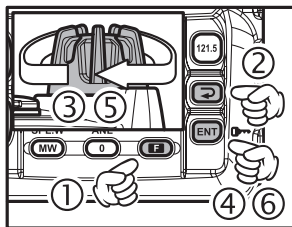

Important Note

- 1) When you select the channel step to 8.33 kHz, the channel display differs from actual operating frequency; see the chart below. However, the operator (pilot, tower, control, etc) will call out the frequency according to what the display indicates.

Operating Frequency	Display	
	8.33 kHz Step	25 kHz Step
1xx.0000 MHz	1xx.005 MHz	1xx.000 MHz
1xx.0083 MHz	1xx.010 MHz	
1xx.0166 MHz	1xx.015 MHz	
1xx.0250 MHz	1xx.030 MHz	1xx.025 MHz
1xx.0333 MHz	1xx.035 MHz	
1xx.0416 MHz	1xx.040 MHz	
1xx.0500 MHz	1xx.055 MHz	1xx.050 MHz
1xx.0583 MHz	1xx.060 MHz	
1xx.0666 MHz	1xx.065 MHz	
1xx.0750 MHz	1xx.080 MHz	1xx.075 MHz
1xx.0833 MHz	1xx.085 MHz	
1xx.0916 MHz	1xx.090 MHz	

- 2) The 8.33 kHz step allows the radio to receive only, and the transmit function is disabled.
- 3) The adjacent channel selectivity will be slightly degraded while receiving using 8.33 kHz channel steps.

ADVANCED OPERATION

VOX Operation

The VOX system provides automatic transmit/receive switching based on voice input to the microphone when using the after-market Headset. With the VOX system enabled, you do not need to press the **PTT** switch in order to transmit.

Note: The VOX system does not function when using just the internal microphone; an external headset must be used.

- Press and hold the [6(DW)] key for 3 seconds to activate the VOX system. The “**VOX**” icon will appear on the display.
- Without pressing the **PTT** switch, speak into the microphone on the Headset in a normal voice level. When you start speaking, the transmitter should be activated automatically. When you finish speaking, the transceiver should return to the receive mode (after a short delay).
- To cancel VOX and return to **PTT** operation, press and hold the [6(DW)] key for 3 seconds; the “**VOX**” icon will disappear from the display.

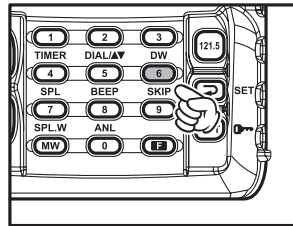

The **FTA-230** provides for adjustment of the VOX Gain via the Menu, to prevent accidental transmitter activation in a noisy environment. To set the VOX Gain:

- Press the [F] key momentarily, then press the [↩(SET)] key to activate the Menu (“SET”) mode.
- Rotate the **DIAL** selector knob to select Menu Item “**VSNS.**”
- Press the [ENT(↵)] key to enable adjustment of this Menu item.
- While speaking into the microphone on the Headset, rotate the **DIAL** selector knob to the point where the transmitter is quickly activated by your voice, without causing background noise to activate the transmitter.
- When you have selected the optimum setting, press the [ENT(↵)] key to save the new setting, and then press the **PTT** switch to exit to normal operation.

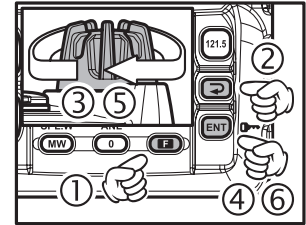

ADVANCED OPERATION

The **FTA-230** also provides for adjustment of the “Hang-Time” of the VOX system (transmit-receive delay after the cessation of speech) via the Menu. The default delay is one second. To set a different delay time:

- ❑ Press the [**F**] key momentarily, then press the [**↔** (**SET**)] key to activate the Menu (“SET”) mode.
- ❑ Rotate the **DIAL** selector knob to select Menu Item “**VDLY.**”
- ❑ Press the [**ENT**(**↔**)] key to enable adjustment of this Menu item.
- ❑ Rotate the **DIAL** selector knob to select the delay time among “05,” “10,” “15,” and “20” (representing 0.5, 1.0, 1.5, and 2.0 sec).
- ❑ When you have made your selection, press the [**ENT**(**↔**)] key to save the new setting, and then press the **PTT** switch to exit to normal operation.

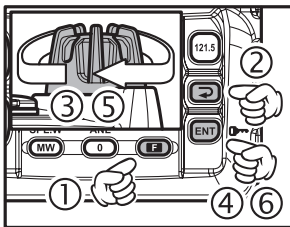

Side Tone Feature (MONITORING YOUR VOICE)

When using the after-market Headset, you may monitor your transmitted voice from the headset for monitoring.

To set the side tone (monitor) level:

- ❑ Press the [**F**] key momentarily, then press the [**↔** (**SET**)] key to activate the Menu (“SET”) mode.
- ❑ Rotate the **DIAL** selector knob to select Menu Item “**STLV.**”
- ❑ Press the [**ENT**(**↔**)] key to enable adjustment of this Menu item.
- ❑ Rotate the **DIAL** selector knob to select the desired monitoring level (1, 2, or 3).
- ❑ When you have made your selection, press the [**ENT**(**↔**)] key to save the new setting, and then press the **PTT** key to exit to normal operation.

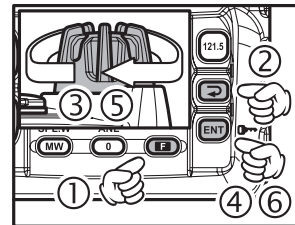

ADVANCED OPERATION

Timer Operation

The **FTA-230** is provided a “Stop Watch” timer and a “Count Down” timer. These can be used for a variety of time-keeping purposes.

- ❑ Press the **[F]** key followed by the **[4(TIMER)]** key to activate the Timer Mode.

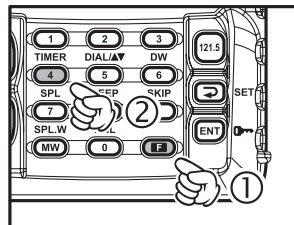

- ❑ Press the **[↶(SET)]** key to toggle the Timer between the “Stop Watch” and “Count Down” timer modes.



“STOP WATCH” TIMER



“COUNT DOWN” TIMER

- ❑ If you select the “Count Down” timer, rotate the **DIAL** knob to set the values for the timer (1 minutes - 60 minutes).
- ❑ The Timer is designed to start/stop/reset repeatedly whenever you press the **[ENT(↵)]** key.
- ❑ In the “Count Down” timer mode, an alert will sound and the timer will stop when the “Count Down” timer reaches “**00 00 00**.”

- ❑ To disable the Timer Mode, press the **[F]** key followed by the **[4(TIMER)]** key again.

MEMORY OPERATION

The **FTA-230** provides 150 user-programmable “Main” memories, labeled “**CH-001**” through “**CH-150**,” and up to 100 pre-programmed memories, designated “Book” Memories. The “” icon appears when the “Book” Memory Mode is activated.

The Main memories and “Book” Memories can be assigned alpha-numeric names of up to eight characters.

Memory System Operation

The **FTA-230**'s Main Memory system allows the user to store, label, and recall channel frequencies which you may want to use frequently. You may store VFO frequencies, Book Memory frequencies, and/or Weather Channel frequencies (USA version only) into the Main Memory system.

Memory Storage

- ❑ Select the desired frequency in the VFO mode, or recall the Book Memory channel or Weather channel to be stored in the Main Memory.

- ❑ **Press and hold** in the [**MW(SPL-W)**] key for 2 seconds. The memory channel number will blink on the LCD.

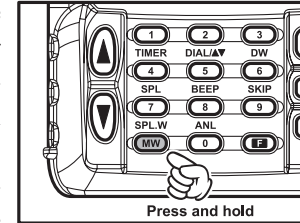

- ❑ Within five seconds of pressing the [**MW(SPL-W)**] key, rotate the **DIAL** selector knob to select the desired memory channel number



for storage. In order to prevent writing over memory channels, an “underline” will appear under the hyphen (located between “CH” and the channel number) to indicate a vacant memory channel.

- ❑ Now press and hold in the [**MW(SPL-W)**] key for 2 seconds; you will now see blinking “**A**” on the LCD. To attach an alpha/numeric name (label) to the memory, proceed to the next step; otherwise



MEMORY OPERATION

press and hold in [**MW(SPL-W)**] for 2 seconds to save the entry and exit.

- ❑ To label a memory with an alpha/numeric name, the next step is to use the **DIAL** selector knob to select any of the 48 available characters (including letters, numbers, and special symbols). When the desired first character appears, press the [**ENT(↵)**] key momentarily to move on to the next character.
- ❑ Select succeeding characters in the same manner, pressing the [**ENT(↵)**] key momentarily after each selection.
- ❑ After entering the entire name (eight characters maximum), press the [**MW(SPL-W)**] key for 2 seconds to save all data for the channel and exit.



Note: If you have transferred a Weather Channel directly to memory, the “WX-01 ~ WX-10” labels utilize the alphanumeric memory, and other labels may not be stored.

ALPHA-TAG CHARACTORS											
A	B	C	D	E	F	G	H	I	J	K	L
M	N	O	P	Q	R	S	T	U	V	W	X
Y	Z		<	>	+	=	*	/	Δ	μ	Σ
	-	0	1	2	3	4	5	6	7	8	9

MEMORY OPERATION

Recalling the Memories

□ Press the [ENT(0)] key, repeatedly if necessary, until “- MR -” (Memory Recall) appears on the display. In the MR mode, you will see “CH-” and the

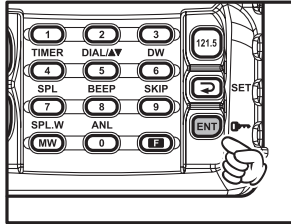

- Rotate the **DIAL** selector knob* to select the desired memory channel.
- You may change the title structure of the Memory display type among:
1. Channel Indication (sequential Channel Number, e.g. CH-001, CH-002, etc.);
 2. Frequency Indication (e.g. 122.500); or
 3. Alphanumeric Label (e.g. LAX FSS).

□ To change the Memory display title, press the [↔(SET)] key repeatedly, if necessary, until you get the desired display title structure.

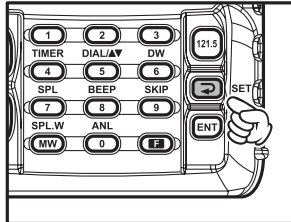

□ To exit the Memory mode, press the [ENT(0)] key three times to return to the VFO mode.

※: If you change a function of **DIAL** and [▼]/[▲] key by pressing the [F] key followed by the [5(DIAL/▼▲)] key, you may select the memory channel by pressing the [▼]/[▲] key.



“CHANNEL INDICATION”



“FREQUENCY INDICATION”

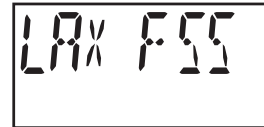

“ALPHANUMERIC LABEL”

MEMORY OPERATION

Deleting Memories

You may delete any of the memories (except for memory channel “001”). The procedure for deleting a channel is quite simple.

- ❑ Press the [F] key momentarily, then press the [↩(SET)] key to activate the Menu (“SET”) mode.
- ❑ Rotate the **DIAL** selector knob to select Menu Item “**MCLR.**”
- ❑ Press the [ENT(↵)] key, then rotate the **DIAL** selector knob to recall the memory channel to be erased.
- ❑ Press the [ENT(↵)] key to clear the Memory channel (the Memory channel number will return to “001”).

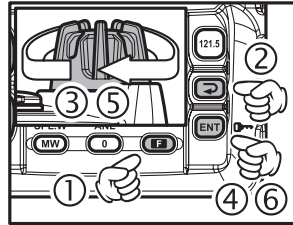

 **Important Notice:** An “erased” channel cannot be restored, and “CH-001” cannot be erased, as it is used for “Priority Channel” operation.

SCANNING OPERATION

The **FTA-230** allows you to scan automatically in the VFO^{※1}, Main Memory, “Book” Memory, or Weather Channel^{※2} modes. It pauses on signals encountered, so you can talk to the station(s) on that frequency, if you like.

※1: In the VFO mode, the automatic scanner is only available in the COM band (118.000 - 136.975 MHz); when the scanner reaches the uppermost frequency in the COM band, it will revert to the bottom end of the COM band and repeat the scanning process until you cancel the scanning process.

※2: USA version only.

If you wish to scan in the NAV band (108.000 - 117.975 MHz), you can do so manually, as described below.

Scanning operation is basically the same in each of the above modes.

- **Press and hold** in the [↶(SET)] key for 2 **seconds** to start the automatic scanner upward (toward a higher frequency or a higher channel number).

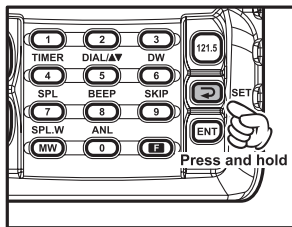

- When the scanner encounters a signal, the scanner will halt on that channel and will hold there for five seconds, after which scanning will resume.
- While the scanner remains paused on a frequency, the decimal point of the frequency displays blinks. The display will be illuminated unless the Scan Lamp Feature is turned off.
- To change the scan direction, turn the **DIAL** selector knob one click in the opposite direction[※].
- To stop the automatic scanner, press the **PTT** switch or the [ENT(↶)] key momentarily. You may also just press the [↷(SET)] key.

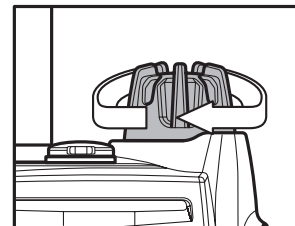

- ※: If you change a function of **DIAL** and [▼]/[▲] key by pressing the [F] key followed by the [5(DIAL/▼▲)] key, you may change the scan direction by pressing the [▼]/[▲] key in the opposite direction.

SCANNING OPERATION

The **FTA-230**'s automatic scanner is not operational in the NAV band (108.000 - 117.975 MHz), because the NAV stations (ILS, etc.) transmit constantly (thereby causing the scanner to stop repeatedly). However, you can scan manually in the NAV band, per the following procedure:

- ❑ Press and hold the [**↶**(SET)] key for 2 seconds to start the manual scanner. Scanning will continue as long as the key is depressed.
- ❑ Release the [**↶**(SET)] key to stop the manual scanner immediately.

Note: When scanning upward in frequency, when the frequency reaches the COM Band (118.000 - 136.975 MHz) via manual scanning, the **FTA-230** will switch to the automatic scanner mode.

Channel-Skip Scanning

Continuous-carrier stations like ATIS (Automatic Terminal Information Service) or Weather Broadcast stations inhibit scanner operation. Since these stations are always active, the scanner will be halted repeatedly on their channels. Such channels can be set to be “skipped” during Memory scanning (MR, Book or WX modes), if you like, so as not to interfere with automatic channel scanning:

- ❑ Recall the Memory Channel to be skipped during scanning.
- ❑ Press the [**F**] key followed by the [**9**(SKIP)] key. The “**SKIP**” icon will appear on the display, indicating that the channel is to be ignored during scanning.

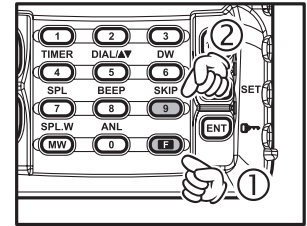

- ❑ You can also designate a channel to be skipped while scanning. When the receiver is halted on a channel that you wish to skip, press and hold the [**↶**(SET)] key for 2 seconds (the “**SKIP**” icon will appear next to the channel to be skipped).
- ❑ Later, to re-enable the memory channel for scanning, repeat the first two steps. The “**SKIP**” icon will disappear by the channel you have just re-enabled.



Note: A memory set to be “skipped” is still accessible for manual memory selection using the **DIAL** selector knob or [**▼**]/[**▲**] key, if you change a function of **DIAL** and [**▼**]/[**▲**] key by pressing the [**F**] key followed by the [**5**(DIAL/▼▲)] key.

DUAL WATCH OPERATION

The Dual Watch feature automatically checks for activity on a “priority” channel[※] while you are operating on another channel. During Dual Watch operation, the current channel and the Priority channel will each be polled for a 500 ms interval, as the **FTA-230** looks for activity on each channel.

- ❑ To start Dual Watch, press the [**F**] key followed by the [**6(DW)**] key. The “**DW**” icon will appear on the display.

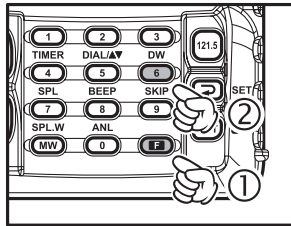

- ❑ While receiving on the “current” channel (not the Priority channel), you may push the **PTT** switch at any time to transmit on that channel.



- ❑ When a signal is received on the Priority channel, operation immediately shifts to the Priority channel, the “**DW**” icon will blink, and the display will become illuminated unless the Scan Lamp Feature is turned off.

- ❑ While receiving on the priority channel, if you momentarily press the **PTT** switch, Dual Watch will be disabled. You may then transmit on the Priority Channel.
- ❑ To stop Dual Watch, press [**F**] key followed by the [**6(DW)**] key.

※: The “priority” Channel is defined as the last-used Memory Channel (when using the VFO mode) or Memory Channel “001” (when using the Main Memory or Book Memory modes).

PRIORITY DUAL WATCH OPERATION

Similar to Dual Watch operation (described on previous page), Priority Dual Watch is an enhanced version which includes the following additional features:

- The receiving time interval (ratio) between the current channel and the Priority channel may be customized via Menu Item “**PRTM**.” See page 43 for details.
- Irrespective of which channel is currently being received, when the **PTT** switch is pushed transmission will always occur on the Priority channel.

Before initiating Priority Dual Watch, Menu Item “**DWMD**” must be set to the “**PRI**: Priority” mode (instead of “**DW**: Dual Watch”). See page 43 for details.

- To start Priority Dual Watch, press the [**F**] key followed by the [**6(DW)**] key. The “**DW**” icon will appear on the display.

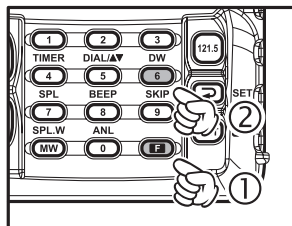

- While receiving on the “current” (non-Priority) channel, pressing the **PTT** switch once causes the radio to switch to the



Priority channel and cancels Dual Watch. Press the **PTT** switch again to transmit on the Priority channel.

- When a signal is received on the Priority channel, reception immediately shifts to the Priority channel, the “**DW**” icon will blink, and the display will become illuminated unless the Scan Lamp Feature is turned off. While receiving on the priority channel, if you momentarily press the **PTT** switch, Priority Dual Watch will be disabled. You may then transmit on the Priority Channel.
- To stop Priority Dual Watch, press the [**F**] key followed by the [**6(DW)**] key.

SPLIT OPERATION

The split operation feature allows you to transmit a call to a Flight Service Station using the COM band frequencies, while receiving an ATIS broadcast (in the NAV band). The ATIS broadcasts are used by airports to notify arriving and departing pilots of the current surface weather conditions, landing and departing runways, runway and taxiway conditions, communication frequencies and other information of importance to arriving and departing aircraft.

Programming a Transmit Frequency

- ❑ Press the [ENT(ENT)] key, repeatedly if necessary, to select the VFO mode.
- ❑ Set a NAV band frequency (108.000 - 117.975 MHz), such as the ATIS broadcast using the **DIAL** selector knob* or keypad.
- ❑ Press the [F] key followed by the [MW(SPL-W)] key. The “**SPL**” icon will blink, and the transmit frequency will appear on the display.

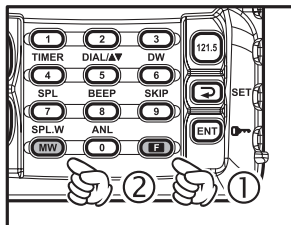
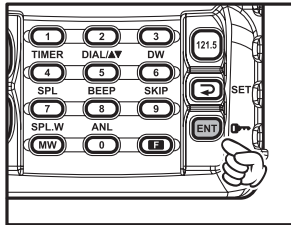

- ❑ Now set your radio's transmit frequency, where the Flight Service Station will be listening for calls, using the **DIAL** selector knob* or keypad.
 - ❑ Press and hold in the [MW(SPL-W)] key for 2 seconds to save the transmit frequency and return to the NAV band frequency.
- ※: If you change the function of **DIAL** and [▼]/[▲] key by pressing the [F] key followed by the [5(DIAL/▼▲)] key, you may set the operating frequency by pressing the [▼]/[▲] key.



Note: You have now stored the separate transmit frequency, but you have not yet activated the split-frequency function; go on to the next section.

SPLIT OPERATION

Operating in the Split Mode

- ❑ It is assumed that you have already set the desired VOR station's frequencies (in the NAV band) per the above instructions.
- ❑ Press the [F] key followed by the [7(SPL)] key to turn on the "Split" function. The "SPL" icon will appear on the display.
- ❑ Press and hold in the **PTT** switch to transmit on the split transmit frequency.
- ❑ Release the **PTT** switch to return to the receive mode.
- ❑ To disable the "Split" function, press the [F] key followed by the [7(SPL)] key again.

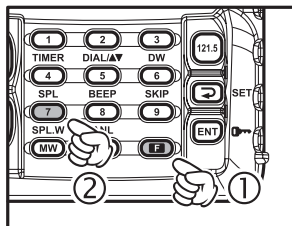

Note: A split frequency can be programmed into each memory channel independently. Set a transmit frequency before programming the memory channel, if desired. The split function on/off setting can also be programmed into a memory channel.



FIELD PROGRAMMING MODE

The **FTA-230**'s Book Memories also allow the user to store, label, and recall channel frequencies which you may want to use frequently while the **FTA-230** is in the Field Programming mode.

Memory Storage into the Book Memory

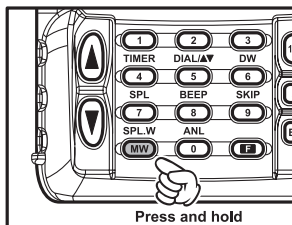
- ❑ Press and hold the **PTT** and [**ENT**()] key while turning the radio on, to activate the Field Programming Mode.
- ❑ Select the desired frequency to be stored in the Book Memory.
- ❑ Press and hold in the [**MW(SPL-W)**] key for 2 seconds. The book memory channel number will blink on the LCD.
- ❑ Within five seconds of pressing the [**MW(SPL-W)**] key, rotate the **DIAL** selector knob to select the desired memory channel number for storage. In order to prevent writing over memory channels, an “underline” will appear under the hyphen (located between “BOOK” and the channel number) to indicate a vacant memory channel.



- ❑ Now press and hold in the [**MW(SPL-W)**] key for 2 seconds; you will now see blinking “**A**” at the left side of the LCD. To attach an alpha/numeric name (label) to the memory, proceed to the next step; otherwise press and hold in the [**MW(SPL-W)**] key for 2 seconds to save the entry and exit.
- 
- ❑ To label a memory with an alpha/numeric name, the next step is to use the **DIAL** selector knob to select any of the 48 available characters (including letters, numbers, and special symbols). When the desired first character appears, press the [**ENT**()] key momentarily to move on to the next character.
 - ❑ Select succeeding characters in the same manner, pressing the [**ENT**()] key momentarily after each selection.
 - ❑ After entering the entire name (eight characters maximum), press the [**MW(SPL-W)**] key for 2 seconds to save all data for the channel.
 - ❑ Repeat this procedure to store additional frequencies into the Book Memory section, as desired.
 - ❑ Turn the radio off, then turn the radio back on again to begin normal operation.



CPU RESETTING

In some instances of erratic or unpredictable operation, the cause may be corruption of data in the microprocessor (due to static electricity, etc.). If this happens, resetting of the microprocessor may restore normal operation. Note that all memories will be erased if you do a complete microprocessor reset, as described below.

To clear all memories and other settings to factory defaults:

- Turn the radio off.
- Press and hold in the [**ENT**()] key and the [**MONITOR**] button, while turning the radio on.

NOTES

MENU (“SET”) MODE

The Menu system allows certain aspects of your radio’s configuration to be customized for your personal operating convenience. We do not recommend that any of the default settings be changed, however, until you are thoroughly familiar with the operation of the **FTA-230**.

1. Press the [**F**] key momentarily, then press the [**↶** (**SET**)] key to activate the Menu (“SET”) mode.

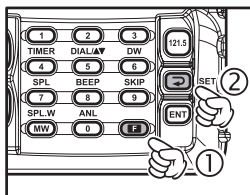

2. Rotate the **DIAL** selector knob to select the Menu Item (feature) you wish to view and/or modify.

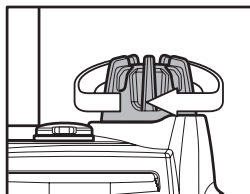

3. Once you have selected the desired Menu Item, press the [**ENT** (**↵**)] key to enable adjustment of this Menu Item. The current setting value will be blinking.

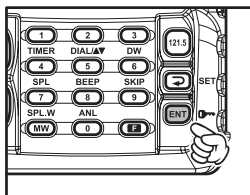

4. Rotate the **DIAL** selector knob to change the setting of the item (“on” to “oFF,” etc.).

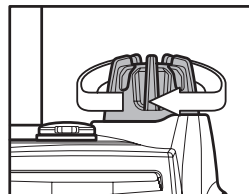

5. Press the [**ENT** (**↵**)] key to save your new setting.

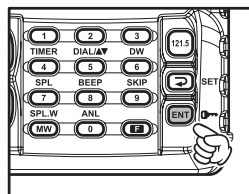

6. If you need to change more than one Menu item, repeat steps 2 - 5.
7. Press the **PTT** switch to exit the Menu (“SET”) mode.

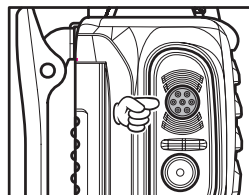

MENU (“SET”) MODE

MENU Listing

A listing of the Menu items available via the SET mode may be found below.

MENU	FUNCTION	Available Values	DEFAULT
SQL	Squelch Level Setting.	0 ~ 8	6
MCLR	Memory Channel Clear (“MR” memory only).	–	–
RESM	Scan-Resume Mode Setting.	5S / CAR	5S
SCNL	Scan Lamp On/Off (while paused).	on / oFF	on
BEEP	Keypad Beeper On/Off.	on / oFF	on
RSVA	Selects the Receive-mode Battery Saver “sleep” ratio.	1:1 ~ 1:5 / oFF / ABS	1:1
LAMP	Display and Keypad Illumination Mode.	KEY / oFF / CNT	KEY
SFT	CPU Clock Shift.	on / oFF	oFF
PRTM	Selects the Priority Checking Time.	05 / 10 / 15 / 20 / 25 / 30	20
DWMD	Selects the Dual Watch/Priority Function.	DW / PRI	DW
POBP	Select the Power on Beep.	MD1 / MD2 / MD3 / oFF	MD1
IMIC	Internal Microphone On/Off.	on / oFF	oFF
EMRG	Emergency channel On/Off.	on / oFF	on
TOT	Setting of the Time-Out Timer countdown time.	1 / 3 / 5 / oFF	oFF
DIMM	Setting of the display brightness level.	LV1 ~ LV4	LV3
WXAF	Selects the Alert functions when receiving the Weather Alert Signal on the WX channel.	BP / LED / B+L / oFF	oFF
VOX	Enables/disables VOX operation.	on / oFF	oFF
VDLY	Selects the VOX delay (“hang”) time.	05 / 10 / 15 / 20	10
VSNS	Sets the VOX sensitivity.	1 ~ 8	4
LOCK	Selects the control locking lockout combination.	K / KD / P / PD / PK / PKD / D	K
STEP	Selects the synthesizer steps.	25 kHz / 8 kHz	25 kHz
BPLV	Sets the Beep level.	1 ~ 3	2
STLV	Sets the Side Tone level.	1 ~ 3	3

MENU (“SET”) MODE

[SQL]

Function: Squelch Level Setting.

Available Values: 0 ~ 8

Default Setting: 6

Select a setting for this Menu item which just silences the receiver when no signal is present. Use the lowest setting which will keep the receiver quiet between incoming transmissions.

[MCLR]

Function: Memory Channel Clear (“MR” memory only).

To clear a Memory channel:

- Select the Menu Item MCLR.
- Press the [ENT(↔)] key, then rotate the DIAL selector knob to recall the memory channel to be erased.
- Press the [ENT(↔)] key to clear the Memory channel (the Memory channel number will return to “001”).

Important Notice: An “erased” channel cannot be restored, and “CH-001” cannot be erased, as it is used for “Priority Channel” operation.

[RESM]

Function: Scan-Resume Mode Setting.

Available Values: 5S/CAR

Default Setting: 5S

“5S” (5-Second Pause) mode:

the scanner will halt for five seconds only, after which scanning will resume (whether or not the other station is still transmitting).

“CAR” (Carrier Drop) mode:

the scanner will remain halted for as long as there is a carrier present on the channel; after the carrier drops at the end of the other station’s transmission, the scanning will resume.

[SCNL]

Function: Scan Lamp On/Off (while paused).

Available Values: on/oFF

Default Setting: on

If you set this function to “on,” the lamp will be illuminated whenever the scanner pauses. The lamp will go off automatically when scanning resumes.

[BEEP]

Function: Keypad Beeper On/Off.

Available Values: on/oFF

Default Setting: on

MENU (“SET”) MODE

[RSAV]

Function: Selects the Receive-mode Battery Saver “sleep” ratio.

Available Values: 1:1 ~ 1:5/oFF/ABS*

Default Setting: 1:1

The setting of 1:5 will promote the greatest conservation of battery capacity, but the receiver’s response time to incoming calls will be slowed somewhat.

*ABS: Automatic Battery Saver, based on activity on the receiver.

Note: This feature does not operate during Scan or Dual Watch.

[LAMP]

Function: Display and Keypad Illumination Mode.

Available Values: KEY/oFF/CNT

Default Setting: KEY

“KEY” mode: The illumination lamp will be activated for 5 seconds when any front panel key or the **DIAL** knob is operated.

“oFF” mode: Disables the illumination lamp.

“CNT” mode: Illuminates the Display/Keypad continuously.

[SFT]

Function: CPU Clock Shift.

Available Values: on/oFF

Default Setting: oFF

This function is only used to move a spurious response “birdie” should it fall on a desired frequency. Consult your Yaesu dealer for details regarding this function.

[PRTM]

Function: Selects the Priority Checking Time.

Available Values: 05/10/15/20/25/30 (0.5/1/1.5/2/2.5/3 sec.)

Default Setting: 20 (2 seconds)

This Menu item allows you to define how often the Priority Channel will be checked for activity.

Note: The Dual Watch Polling time is 500 mS (fixed).

[DWMD]

Function: Selects the Dual Watch/Priority Function.

Available Values: DW/PRI

Default Setting: DW

“DW” mode: The **FTA-230** will activate the Dual Watch feature when you press the **[F]** key followed by the **[6(DW)]** key.

“PRI” mode: The **FTA-230** will activate the Priority feature when you press the **[F]** key followed by the **[6(DW)]** key.

MENU (“SET”) MODE

[POBP]

Function: Select the Power on Beep.

Available Values: MD1/MD2/MD3/oFF

Default Setting: MD1

Note: You will hear the different selections as you rotate the **DIAL** selector knob.

[IMIC]

Function: Internal Microphone On/Off.

Available Values: on/oFF

Default Setting: oFF

This controls the status of the radio’s internal microphone when an external microphone (such as the **MH-44A4B** Speaker Microphone or an aviation headset connected via the **CT-60** Headset Cable) is in use. In most applications, set this Menu Item to “oFF” for proper operation (this disables the internal microphone). The internal microphone will still function normally when the external microphone is disconnected.

[EMRG]

Function: Emergency channel On/Off.

Available Values: on/oFF

Default Setting: on

This controls the operation of the Emergency [**121.5**] key. When set to “oFF,” this key will not function. You can still use the frequency 121.5 MHz either by entering it on the keypad in the VFO mode, or by recalling it on a previously-stored memory channel.

[TOT]

Function: Setting of the Time-Out Timer countdown time.

Available Values: 1/3/5/oFF (minutes)

Default Setting: oFF

The Time-Out Timer shuts off the transceiver after continuous transmission exceeds the programmed time.

[DIMM]

Function: Setting of the display brightness level.

Available Values: LV1 ~ LV4

Default Setting: LV3

MENU (“SET”) MODE

[WXAF]

Function: Selects the Alert functions when receiving the Weather Alert Signal on the WX channel.

Available Values: BP/LED/B+L/oFF

Default Setting: oFF

BP: Sounds a loud beep when receiving the Weather Alert Signal.

LED: Flashes the back light of the Display/Keypad when receiving the Weather Alert Signal.

B+L: Sounds a loud beep and flashes the back light of the Display/Keypad when receiving the Weather Alert Signal.

oFF: Disables the Alert function.

To stop the loud beep and/or back light flashing, press any key (except [▼]/[▲] key)

When the Weather Alert function is activated, the “(A)” icon will appear on the display.

[VOX]

Function: Enables/disables VOX operation.

Available Values: on/oFF

Default Setting: oFF

[VDLY]

Function: Selects the VOX delay (“hang”) time.

Available Values: 05/10/15/20 (x0.1 sec)

Default Setting: 10 (x0.1 sec)

[VSNS]

Function: Sets the VOX sensitivity.

Available Values: 1 ~ 8

Default Setting: 4

[LOCK]

Function: Selects the control locking lockout combination.

Available Values: K/KD/P/PD/PK/PKD/D

Default Setting: K

K: Keypad, D: **DIAL** knob, P: **PTT** switch

(Other selections are combinations of these lock-out choices)

[STEP]

Function: Selects the synthesizer steps.

Available Values: 25 kHz/8 kHz

Default Values: 25 kHz

[BPLV]

Function: Sets the Beep level.

Available Values: 1~ 3

Default Setting: 2

[STLV]

Function: Sets the Side tone level.

Available Values: 1 ~ 3

Default Setting: 3

SPECIFICATIONS

General

Frequency Range:	TX: 118.000 - 136.975 MHz, RX: 108.000 - 136.975 MHz, Weather Channels (WX-01 - WX-10: USA version only)
Channel Spacing:	25 kHz / 8.33 kHz (8.33 kHz: RX only)
Emission Type:	TX: AM, RX: AM & FM (FM: for receiving the Weather Channels, USA version only)
Supply Voltage:	6.0 - 15.0 VDC
Current Consumption (approx.):	250 μ A (power off), 35 mA (battery saver on, saver ratio 1:5) 60 mA (squelch on), 200 mA (receive), 850 mA (transmit 1.5 W Carrier)
Temperature Range:	+14 °F to +140 °F (-10 °C to +60 °C)
Case Size (WxHxD):	2.36 x 4.09 x 1.2 inches (60 x 104 x 30.5 mm) w/o knob & antenna
Weight (approx.):	12.7 oz (360 grams) with FNB-83, antenna, and belt clip

Receiver

Circuit Type:	Double-conversion superheterodyne
IFs:	47.25 MHz & 450 kHz
Sensitivity:	AM: Better than 0.8 μ V (for 6 dB S/N with 1 kHz, 30 % modulation) FM: Better than 0.4 μ V (for 12 dB SINAD)
Selectivity:	More than 8 kHz/-6 dB
Adjacent CH. Selectivity:	Less than 25 kHz/-60 dB
AF Output (Internal speaker):	0.7 W @ 16 Ohms, 10 % THD

SPECIFICATIONS

Transmitter

Power Output (@ 7.2 V):	5 W (PEP), 1.5 W (Carrier Power)
Frequency Stability:	Better than ± 10 ppm (+14 °F to + 140 °F [-10 °C to +60 °C])
Modulation System:	Low Level Amplitude Modulation
Spurious Emission:	>60 dB below carrier
Int. Microphone Type:	Condenser
Ext. Mic. Impedance:	150 Ohms

Specifications are subject to change without notice or obligation.

TROUBLESHOOTING

QUESTION	ANSWER
When connecting the CT-96 headset cable between the radio and a headset, the red transmit LED on the radio turns on and the radio cannot be operated.	This happens when the connector on the CT-96 headset cable is simply pushed into the MIC/EAR jack. The jack must be screwed into the MIC/EAR jack to make proper contacts within the radio.
Can I purchase the optional PTT Switch from Yaesu?	Contact your Aviation dealer for details on purchasing an aftermarket Push-To-Talk switch.
Will my headset work with this radio?	The CT-96 headset cable is made to operate with most headsets; however to be concretely sure check with the headset manufacturer providing the wiring shown below. Please confirm the connections and connector sizes are correct.

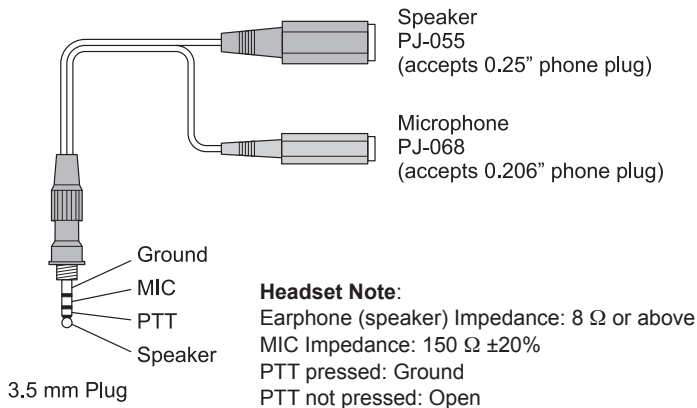

BOOK MEMORY CHANNEL LIST (USA VERSION: FACTORY DEFAULT)

CH No.	ALPHA TAG	FREQUENCY (MHZ)	NOTE	CH No.	ALPHA TAG	FREQUENCY (MHZ)	NOTE
1	AIR-AIR	123.450	Unofficial Air-Air	31	ARTCC 07	136.175	Air Traffic Control General Use
2	AIR-AIR	131.800	Air to Air	32	ARTCC 08	136.225	Air Traffic Control General Use
3	ARINC 01	136.500	Aeronautical Enroute Channel	33	ARTCC 09	136.250	Air Traffic Control General Use
4	ARINC 02	136.525	Aeronautical Enroute Channel	34	ARTCC 10	136.300	Air Traffic Control General Use
5	ARINC 03	136.550	Aeronautical Enroute Channel	35	ARTCC 11	136.325	Air Traffic Control General Use
6	ARINC 04	136.575	Aeronautical Enroute Channel	36	ARTCC 12	136.350	Air Traffic Control General Use
7	ARINC 05	136.600	Aeronautical Enroute Channel	37	ARTCC 13	136.400	Air Traffic Control General Use
8	ARINC 06	136.625	Aeronautical Enroute Channel	38	ARTCC 14	136.425	Air Traffic Control General Use
9	ARINC 07	136.650	Aeronautical Enroute Channel	39	ARTCC 15	136.450	Air Traffic Control General Use
10	ARINC 08	136.675	Aeronautical Enroute Channel	40	FAS	122.000	Enroute Flight Advisory Service
11	ARINC 09	136.700	Aeronautical Enroute Channel	41	FOREST	122.925	Forest Management
12	ARINC 10	136.725	Aeronautical Enroute Channel	42	FSS	123.600	Flight Service Station
13	ARINC 11	136.750	Aeronautical Enroute Channel	43	HLC AIR	123.025	Helicopter Air to Air
14	ARINC 12	136.775	Aeronautical Enroute Channel	44	INTL G/C	130.700	International Gulf/Caribbean
15	ARINC 13	136.800	Aeronautical Enroute Channel	45	INTL NY	129.900	International New York
16	ARINC 14	136.825	Aeronautical Enroute Channel	46	INTL SF	131.950	International San Francisco
17	ARINC 15	136.850	Aeronautical Enroute Channel	47	MIL TWR	126.200	Military Tower
18	ARINC 16	136.875	Aeronautical Enroute Channel	48	RESCUE	123.100	Search and Rescue
19	ARINC 17	136.900	Aeronautical Enroute Channel	49	RESCUE T	122.900	Training Search and Rescue
20	ARINC 18	136.925	Aeronautical Enroute Channel	50	SCHOOL 1	123.300	Flight Schools
21	ARINC 19	136.950	Aeronautical Enroute Channel	51	SCHOOL 2	123.500	Flight Schools
22	ARINC 20	136.925	Aeronautical Enroute Channel	52	UNICOM 1	122.700	Unicom-Airports without towers
23	ARINC 21	136.950	Aeronautical Enroute Channel	53	UNICOM 2	122.725	Unicom-Private Airports
24	ARINC 22	136.975	Aeronautical Enroute Channel	54	UNICOM 3	122.750	Unicom-Air to Air
25	ARTCC 01	136.000	Air Traffic Control General Use	55	UNICOM 4	122.800	Unicom-Airports without towers
26	ARTCC 02	136.025	Air Traffic Control General Use	56	UNICOM 5	122.950	Unicom-Airports with towers
27	ARTCC 03	136.050	Air Traffic Control General Use	57	UNICOM 6	123.000	Unicom-Airports without towers
28	ARTCC 04	136.075	Air Traffic Control General Use	58	UNICOM 7	123.050	Unicom-Heliports
29	ARTCC 05	136.125	Air Traffic Control General Use	59	UNICOM 8	123.075	Unicom-Heliports
30	ARTCC 06	136.150	Air Traffic Control General Use	-	---	---	---

BOOK MEMORY CHANNEL LIST (EXP VERSION: FACTORY DEFAULT)

CH No.	ALPHA TAG	FREQUENCY (MHZ)	NOTE	CH No.	ALPHA TAG	FREQUENCY (MHZ)	NOTE
1	AMS VMT	126.200	AMSTERDAM MET BROADCAST	42	WAW VMT	127.600	WARSAW VOLMET
2	ANK VMT	127.000	ANKARA (ESENBOGA MET BROADCAST)	43	ZRH VMT	127.200	ZURICH MET
3	ATH VMT	127.800	ATHENS(ATHINAI VOLMET)	50	AMS ATIS	132.975	AMSTERDAM(Schiphol)
4	BCN VMT	127.600	BARCELONA	51	AMS ATIS	122.200	AMSTERDAM(Schiphol)
5	BEG VMT	126.400	BELGRADE VOLMET	52	ESB ATIS	123.600	ANKARA(Esenboga)
6	BER VMT	128.400	BERLIN VOLMET	53	ATH ATIS	123.400	ATHENS
7	BOO VMT	124.250	BODO VOLMET	54	BCN ATIS	118.650	BARCELONA
8	BOD1 VMT	126.400	BORDEAUX RADIO	55	BEG ATIS	119.500	BELGRADE
9	BOD2 VMT	127.000	BORDEAUX RADIO	56	TXL ATIS	125.900	BERLIN(Tegel)
10	BRU VMT	127.800	BRUSSELS	57	BOO ATIS	123.900	BODO
11	BUH VMT	126.800	BUCHAREST VOLMET	58	BOD ATIS	131.150	BORDEAUX(Merignac)
12	BUD VMT	127.400	BUDAPEST VOLMET	59	BRU ATIS	132.475	BRUSSELS(National)
13	CPH VMT	127.000	COPENHAGEN VOLMET	60	OTP ATIS	118.500	BUCHAREST(Otopeni)
14	DUB VMT	127.000	DUBLIN VOLMET	61	BUD ATIS	124.650	BUDAPEST(Ferihegy)
15	FRA1 VMT	127.600	FRANKFURT 1 VOLMET	62	FRA ATIS	118.025	FRANKFURT(Main)
16	FRA2 VMT	135.775	FRANKFURT 2 VOLMET	63	GVA ATIS	135.575	GENEVA(Cointrin)
17	GVA VMT	126.800	GENEVA MET BROADCAST	64	CPH ATIS	122.750	COPENHAGEN(Kastrup)
18	HEL VMT	128.400	HELSINKI VOLMET	65	CPH ATIS	122.850	COPENHAGEN(Kastrup)
19	INN VMT	130.475	INNSBRUCK (NATIONAL VOLMET INNSBRUCK AUSTRIA)	66	DUB ATIS	124.525	DUBLIN
20	IST VMT	127.400	ISTANBUL(ATATURK MET BROADCAST)	67	LGW ATIS	136.525	LONDON(Gatwick)
21	LPA VMT	126.200	LAS PALMAS VOLMET	68	LHR ATIS	123.900	LONDON(Heathrow)
22	LIS VMT	126.400	LISBON(LISBOA VOLMET)	69	HEL ATIS	135.075	HELSINKI(Vantaa)
23	LON1 VMT	135.375	LONDON VOLMET(MAIN)	70	INN ATIS	126.025	INNSBRUCK
24	LON2 VMT	128.600	LONDON VOLMET(SOUTH)	71	IST ATIS	128.200	ISTANBUL(Ataturk)
25	LON3 VMT	126.600	LONDON VOLMET(NORTH)	72	FBU ATIS	126.125	OSLO(Fornebu)
26	MAD VMT	126.200	MADRID VOLMET	73	CDG ATIS	128.000	PARIS(Charles de Gaulle)
27	MRS1 VMT	127.400	MARSEILLE RADIO	74	ORY ATIS	126.500	PARIS(Orly)
28	MRS2 VMT	128.600	MARSEILLE RADIO	75	PRG ATIS	122.150	PRAGUE(Ruzyne)
29	MIL VMT	126.600	MILAN(MILANO VOLMET)	76	FCO ATIS	121.700	ROME(Fiumicino)
30	MOW VMT	127.875	MOSCOW VOLMET	77	MAD ATIS	118.250	MADRID(Barajas)
31	OSL VMT	128.600	OSLO VOLMET	78	MRS ATIS	125.350	MARSEILLE(Provence)
32	PAR1 VMT	126.000	PARIS RADIO	79	SVO ATIS	126.375	MOSCOW(Sheremetievo)
33	PAR2 VMT	125.150	PARIS RADIO	80	VKO ATIS	125.875	MOSCOW(Vnukovo)
34	PRG VMT	128.600	PRAGUE VOLMET	81	LED ATIS	127.400	ST. PETERBURG(Pulkovo)
35	ROM VMT	126.000	ROME VOLMET	82	SOF ATIS	124.050	SOFIA
36	LED VMT	125.875	ST. PETERSBURG VOLMET	83	ARN ATIS	119.000	STOCKHOLM(Arlanda)
37	SOF VMT	126.600	SOFIA VOLMET	84	ARN ATIS	121.625	STOCKHOLM(Arlanda)
38	STO VMT	127.600	STOCKHOLM VOLMET	85	TLV ATIS	132.500	TEL AVIV(Ben Gurion Intl)
39	SDL VMT	127.800	SUNDSVALL VOLMET	86	VIE ATIS	122.950	VIENNA(Schwechat)
40	TLV VMT	126.800	TEL AVIV(BEN GURION RADIO)	87	WAW ATIS	120.450	WARSAW(Okęcie)
41	VIE VMT	126.000	VIENNA(VOLMET WIEN AUSTRIA)	88	ZRH ATIS	128.525	ZURICH

Quick Reference

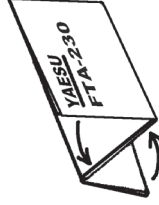
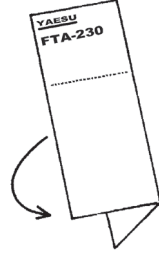
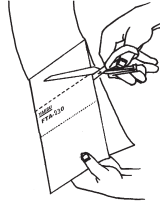

(Cut Here)

YAESU
The radio

FTA-230

Quick Reference Card

YAESU MUSEN CO., LTD.

Tag Channels (Memory Display)

1. Press the [ENT(☛)] key several times to select -MR- mode.
2. Press the [↔(SET)] key to change Memory display.

Mode Selection

Press the [ENT(☛)] key to switch the operating mode between the VFO mode, Memory mode, Book mode and WX mode.

Memory Programming

Select the desired frequency in the VFO mode, or recall the "Book" Memory channel or Weather channel to be stored in the Main Memory.

1. Press and hold in the [MW(SPL.W)] key.
2. Rotate the DIAL selector knob to select the desired memory channel number for storage.
3. Press and hold in the [MW (SPL.W)] key.
4. Rotate the DIAL selector knob to select any of the character.
5. When the desired first character appears, Press the [ENT(☛)] key momentarily to move on to the next character.
6. After entering the entire name (eight characters maximum), pressing the [MW(SPL.W)] key for 2 seconds to save all data for the channel and exit.

Lock Function

Press the [F] key, Then press the [ENT(☛)] key.

Frequency Recall (Flip-Flop)

1. Press the [ENT(☛)] key several times to select -VFO- mode.
2. Press the [↔(SET)] key to select -F/F- mode on the VFO mode.
3. Rotate the DIAL selector knob or press the UP/DWN key to select previous frequency.

Field Programming Mode

1. Press and hold in both the PTT switch and [ENT(☛)] key while turning the radio on.
2. Select the desired frequency to be stored in the Book Memory.
3. Press and hold in the [MW(SPL.W)] key for 2 seconds.
4. Rotate the DIAL selector knob to select the desired memory channel number for storage.
5. Press and hold in the [MW(SPL.W)] key for 2 seconds.
To attach an alpha/numeric name (label) to the memory, proceed to the next step; otherwise press and hold in the [MW(SPL.W)] key for 2 seconds to save the entry and exit.
6. To label a memory with an alpha/numeric name, the next step is to use the DIAL selector knob to select any of the 48 available characters.
7. Press the [ENT(☛)] key momentarily to select it and move on to the next character.
8. After entering the entire name (eight characters maximum), press the [MW(SPL.W)] key for 2 seconds to save all data for the channel.
9. Turn the radio off, then turn the radio back on again to begin normal operation.

Part 15.21: Changes or modifications to this device
not expressly approved by YAESU MUSEN could
void the user's authorization to operate this device.

YAESU

The radio

YAESU MUSEN CO., LTD.

Tennozu Parkside Building
2-5-8 Higashi-Shinagawa, Shinagawa-ku, Tokyo 140-0002 Japan

YAESU USA

6125 Phyllis Drive, Cypress, CA 90630, U.S.A.

YAESU UK

Unit 12, Sun Valley Business Park, Winnall Close
Winchester, Hampshire, SO23 0LB, U.K.

YAESU HK

Unit 2002, 20/F, 9 Chong Yip Street,
Kwun Tong, Kowloon, Hong Kong

Copyright 2012

YAESU MUSEN CO., LTD.

All rights reserved.

No portion of this manual may be
reproduced without the permission of
YAESU MUSEN CO., LTD.

Printed in Japan



EC072N150