

Vertex Standard

VX-1400

OPERATING MANUAL



MH-67A&J Hand Microphone is optional.

VERTEX STANDARD CO., LTD.

4-8-8 Nakameguro, Meguro-Ku, Tokyo 153-8644, Japan

VERTEX STANDARD

US Headquarters

10900 Walker Street, Cypress, CA 90630, U.S.A.

YAESU UK LTD.

Unit 12, Sun Valley Business Park, Winnall Close
Winchester, Hampshire, SO23 0LB, U.K.

VERTEX STANDARD HK LTD.

Unit 5, 20/F., Seaview Centre, 139-141 Hoi Bun Road,
Kwun Tong, Kowloon, Hong Kong

VERTEX STANDARD (AUSTRALIA) PTY., LTD.

Normanby Business Park, Unit 14/45 Normanby Road
Notting Hill 3168, Victoria, Australia

Table of Contents

VX-1400 Quick Reference Guide	1
Button Overview / Reset Procedure	2
General	3
Front Panel Control & Switches	4
Rear Panel Connections	6
Installation	7
Safety Precautions	7
Power Connections	7
Grounding for Electrical Safety	7
Electrical Shock Prevention	7
Antenna Precautions	8
Heat and Ventilation	8
Electromagnetic Compatibility and RF Exposure	9
Preliminary Inspection	9
Power Requirements and Basic Installation	10
DC Power Connections	10
Mobile Mounting	12
Mobile Antenna Considerations	12
Mobile Station Grounding	14
Base Station Installation	15
DC Power Connections	15
Base Station Antenna Considerations	16
Base Station Grounding	18
Operation	20
Turning the Transceiver “On” and “Off”	20
Reception	20
Frequency and Channel Selection	22
VFO Mode	23
Memory Channel Mode	24
ITU Marine Channel	24
Transmission	25
Antenna Tuning Procedures	26
Dual Watch	27
Encrypted Transmission/Reception	28
2.182 MHz Emergency Channel Mode	29
Selcall/Telcall Operation	30
General	30
SelCall	31
Message Call	32
Position Request Call	33
Position Send Call	34
Beacon Request Call	35
Telcall	36
ALE Operation	38
Sending an ALE Call	38
Sending an ALE Call with an Imbedded Message	39
Receiving an ALE Call	39
Memory Channel Storage	40
Programmable Function (PF) Buttons	42
Installation of the Option	49
ALE-2 Automatic Link Establishment Unit	49
CT-139 Accessory Cable	50
Accessories and Options	52
Supplied Accessories	52
Available Options	52

VX-1400 QUICK REFERENCE GUIDE

You can do the basic operation of the **VX-1400** according to the number order of the illustration below.

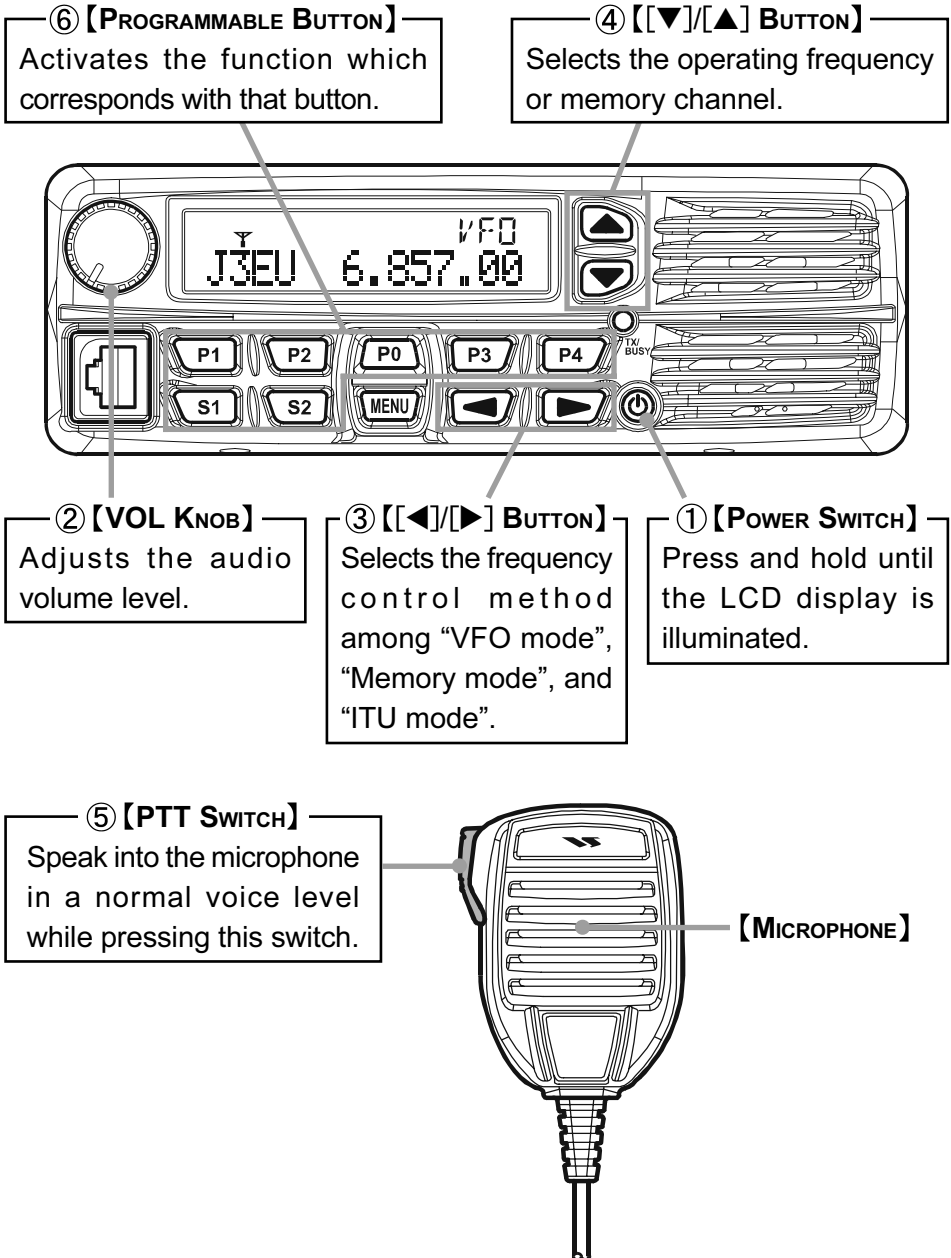

BUTTON OVERVIEW/RESET PROCEDURE

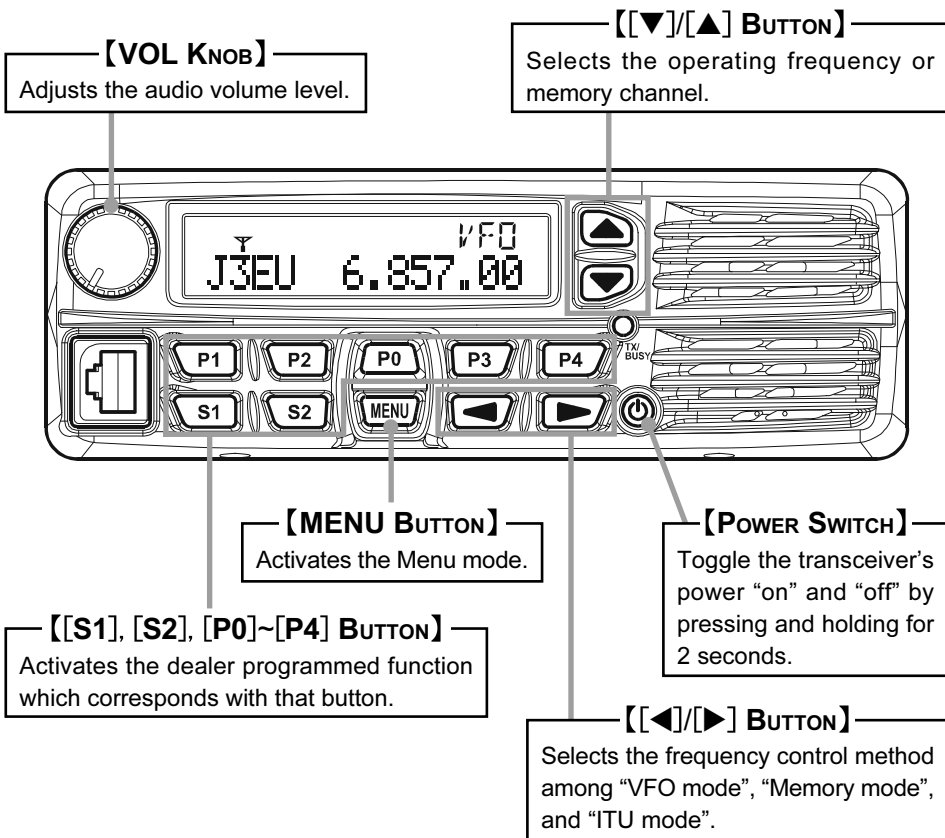

RESET PROCEDURES

When you lose the operation procedure, or if radio operation becomes erratic, you may reset all settings to the factory default by the following procedure:

- Press and hold the **[POWER(⏻)]** switch to turn the radio off.
- Press and hold the **[MENU]** button while turning the radio on. The confirmation message appears. Reset? Y:▼ N:←
- Press the **[▼]** button to reset all settings to dealer default (press the **[◀]** button to cancel the reset procedure).

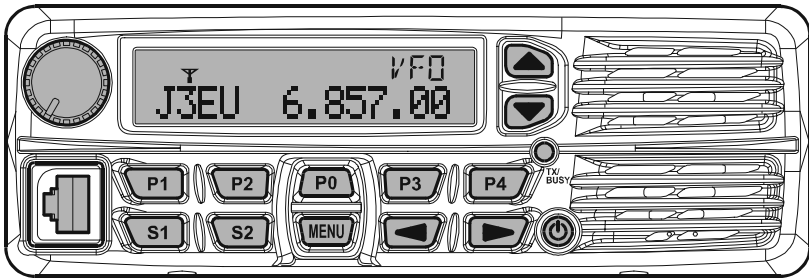

The Vertex Standard **VX-1400** is a low-cost, rugged, small size, integrated HF communications transceiver designed for the worldwide Land Mobile, Government, and Marine markets. The **VX-1400** conforms with MIL-810 C, D, E, & F. The front panel is water resistance to IP54 specifications when in remote control operation using the optional **RMK-1400** Remote Mounting Kit with the **MH-77A8J/B8J** Water Resistance Hand Microphone.

The Vertex Standard **VX-1400** provides continuous receiver coverage from 30 kHz to 30 MHz, and transmitter coverage is specified as 1.6MHz to 30MHz, depending upon the external antenna(s) and antenna tuner/coupler equipment utilized. Operating modes provided include J2B (USB or LSB), J3E (USB or LSB), A1A, A3E, and H3E (only on 2182 kHz Emergency Channel Mode), making the **VX-1400** ideal for a wide variety of voice, telephony, and many data communication applications.

Advanced features of the Vertex Standard **VX-1400** include 512 memory channels (arranged in five banks), keyboard frequency entry with frequency resolution to 10 Hz, and Alpha-Numeric labeling of Memory channels. Ease in programming fleet systems is provided. Also the Selcall feature allows paging of a single transceiver or groups of transceivers by a dispatch center.

Available options include the **FP-1030A** AC Power Supply, **FC-30** Automatic External Antenna Tuner (for 50 Ohm unbalanced antenna feedlines), **FC-40** Automatic External Antenna Tuner (for an end-fed random-length wire or long whip antenna), **YA-30** Broadband Dipole Antenna, **YA-31** Broadband Antenna, **YA-007FG** Mobile Antenna, **MD-12A8J** Desk Microphone, **MLS-100/-200** External Speaker, and the **ALE-2** Automatic Link Establishment Unit which automatically selects the channel with the best LQA (Link Quality Analysis) score from the programmed channels.

This manual includes installation, configuration, interfacing and operating instructions for the Vertex Standard **VX-1400**. We encourage you to read this manual thoroughly before installing or operating this transceiver.

FRONT PANEL CONTROL & SWITCHES

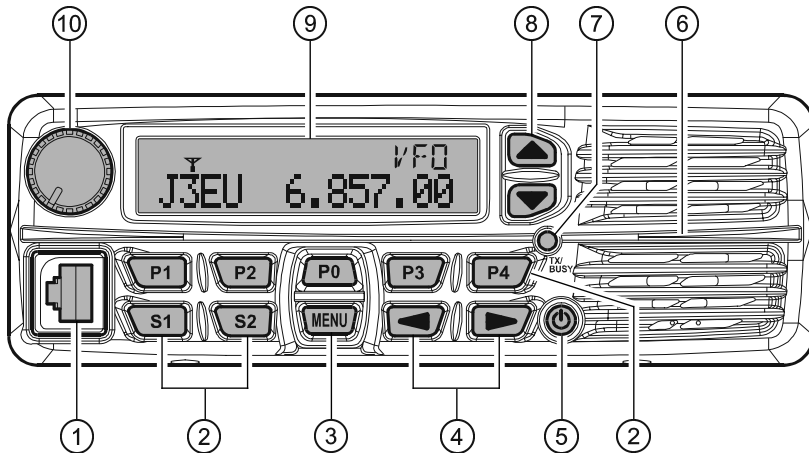

① MIC Jack

This modular jack accepts microphone voice input, as well as scanning and PTT (Push To Talk) control from the microphone. Specified microphone impedance is 500 - 600 Ohms.

② [S1], [S2], [P0] - [P4] Button (PROGRAMMABLE FUNCTION BUTTONS)

These seven buttons functions can be customized via programming by your Vertex Standard dealer. The factory defaults are shown below.

[S1] button: Press this button to toggle the Display Brightness Level between “High” and “Low”.

[S2] button: Press this button to toggle the Noise Blanker “on” and “off.”.

[P0] button: Press this button to change the synthesizer step in the VFO mode.

[P1] button: Press this button to activate the Antenna Tuning Process.

[P2] button: Press this button to activate the “Squelch Adjusting” mode (for quieting random noise).

[P3] button: Press this button to activates the Clarifier function (allows tuning the receiver frequency without changing the transmit frequency).

[P4] button: Press this button to select the operating mode.

③ [MENU] Button

Pressing this button activates the Menu mode which changes the configuration of the transceiver’s parameter.

④ [◀]/[▶] Button

Pressing these buttons selects the frequency control method among “VFO mode”, “Memory mode”, and “ITU mode”.

FRONT PANEL CONTROL & SWITCHES

⑤ [POWER(🔌)] Switch

This is the main on/off switch for the **VX-1400**. Press and hold this switch for 2 seconds to toggle the transceiver's power on and off.

⑥ Speaker

The internal speaker is located here.

⑦ TX/BUSY LED

This indicator glows green when a signal is being received and red when transmitting.

⑧ [▼]/[▲] Button

Pressing these buttons selects the operating frequency (while in the VFO mode) or memory channel (while in the Memory mode and ITU mode).

⑨ LCD Display

This multi function LCD (Liquid Crystal Display) includes frequency readout or Alpha/Numeric "Tag" labeling of the channel in use, plus a Signal Strength/Power Output meter, and icons which provide visual confirmation of transceiver status.

⑩ VOL Knob

This control adjusts the receiver audio volume from the speaker. Clockwise rotation of this control increases the volume level.

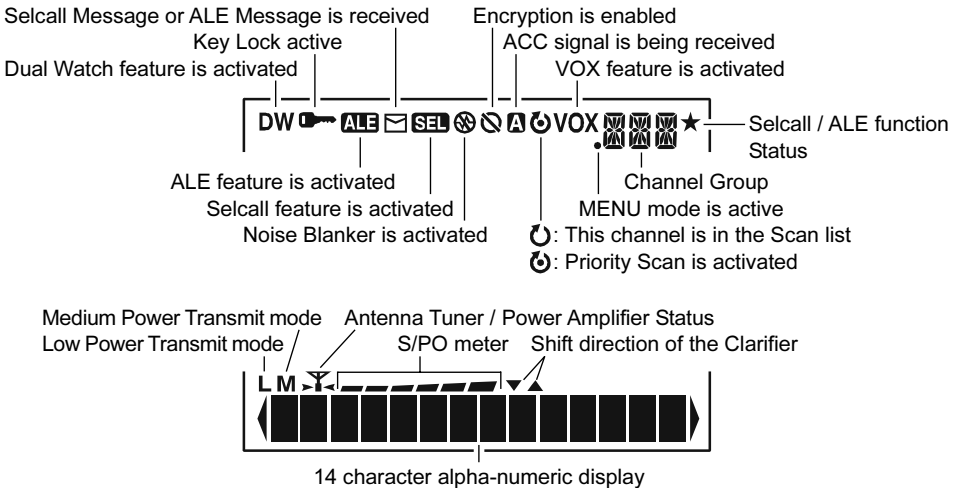

REAR PANEL CONNECTIONS

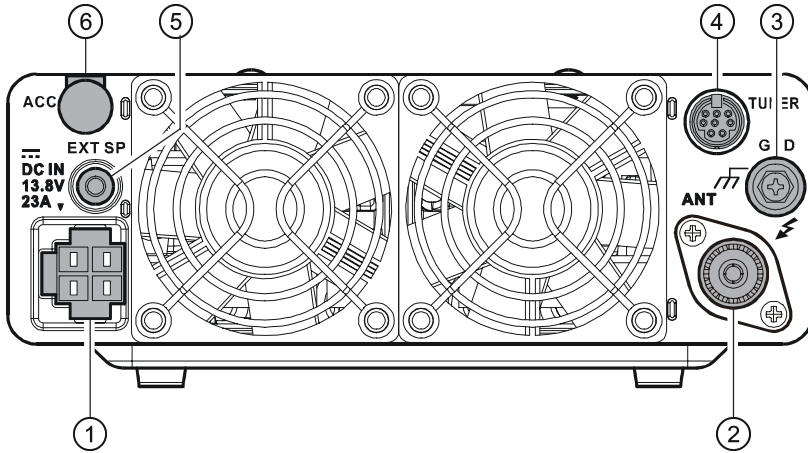

① DC IN 13.8V

This is the main DC power input jack for the **VX-1400**.

② ANT Jack

This PL-259 (“M” Type) connector is used for connection of the coaxial feedline from the antenna. When the optional **FC-30** or **FC-40** External Antenna Tuner is used, the RF interconnection cable from the **FC-30** or **FC-40** connects here, while the antenna wire or whip connects to the **FC-30** or **FC-40**.

③ GND Terminal Post

Use this terminal to connect the transceiver to a good earth ground bus, for safety and optimum performance. Use a large diameter, short braided cable.

④ TUNER Jack

This 8-pin mini-DIN jack is for interconnection to the optional **FC-30** or **FC-40** External Antenna Tuner.

⑤ EXT SP Jack

This 3.5-mm miniature phone jack provides receiver audio output for an external speaker. Available audio output is 10 Watts, and the permitted impedance is 4 to 16 Ohms. Inserting a plug into this jack automatically disables the internal speaker.

Caution: Do not connect this line to ground, and be certain that the speaker has adequate capability to handle the audio output from the **VX-1400**.

⑥ ACC Out

This hole which is blocked by the rubber cap is a hole to draw the optional **CT-139** Accessory Cable.

SAFETY PRECAUTIONS

Before proceeding with installation of the **VX-1400** transceiver, please read and observe all safety and operating instructions. Consult with qualified installation or service personnel should any questions arise regarding these important safety tips.

Power Connections

The power connector for the **VX-1400** must only be connected to a DC source providing 13.8 Volts DC ($\pm 15\%$), and capable of at least 23 Amperes of current. Do not connect this apparatus to any other DC voltage, and never connect the DC power cable to an AC source of any kind. Always observe proper polarity when making DC connections. Our Limited Warranty does not cover damage caused by improper power connections.

Note that other manufacturers may use the same type of DC power connector as does your **VX-1400** transceiver, but the wiring configuration of the other manufacturer's plug may be different from that specified for your transceiver. Serious damage can be caused if improper DC connections are made; consult with a qualified service technician when in doubt.

Grounding for Electrical Safety

Connect the rear panel ground lug to a good earth ground. For best performance, such a ground should consist of one or more ground rods 2.6 m (8 feet) long, connected to the transceiver via a low-inductance cable such as a heavy braided wire (the shield from surplus/discarded RG-213 type cable is ideal). The lead-in cable should be as short as possible.



Do not use gas lines as a ground connection!

Electrical Shock Prevention

Be certain that all station wiring is properly insulated so as to prevent short-circuits which could damage this transceiver and/or accessories connected to it. Be sure to protect power cables from damage due to abrasion by ensuring that they cannot be walked upon nor crushed under rolling chairs, etc. Never route power cables near sharp metallic edges which might cut through protective insulation.

Never spill liquids into this transceiver, and do not drop metallic objects into the transceiver enclosure. Electrical shock may result when you attempt to remove the object.

Unsupervised children should be kept away from any electrical apparatus such as the **VX-1400** Transceiver and its accessories.

INSTALLATION

SAFETY PRECAUTIONS

Antenna Precautions

Always locate antennas such that they can never come in contact with outdoor power lines in the event of a catastrophic antenna support or power line support structure failure. Ground the support structure adequately, so as to dissipate energy absorbed during a lightning strike. Install appropriate lightning arrestors in the antenna lead-in and rotator cable (if used) according to the arrestor's instructions.

In the event of an approaching electrical storm, disconnect all antenna lead-in, rotator cables, and power cables completely from your station if the storm is not immediately in your area. Do not allow disconnected cables to touch the case of your **VX-1400** transceiver or accessories, as lightning can easily jump from the cable to the circuitry of your transceiver via the case, causing irreparable damage. If a lightning storm is in progress in your immediate area, do not attempt to disconnect the cables, as you could be killed instantly if lightning should strike your antenna structure or a nearby power line.

If a vertical antenna is utilized, be certain that humans and/or pets and farm animals are kept away both from the radiating element (to prevent electrical shock and RF exposure danger) and the ground system, in the event of an electrical storm. The buried radials of a ground-mounted vertical antenna can carry lethal voltages outward from the center of the antenna in the event of a direct lightning strike.

Heat and Ventilation

To ensure long life of the components, be certain to provide adequate ventilation around the cabinet of the **VX-1400**. The cooling system of the transceiver must be free to draw cool air in from the bottom of the transceiver and expel warm air from the rear of the transceiver.

Do not install the transceiver on top of another heat-generating device (such as a linear amplifier), and do not place equipment, books, or papers on top of the transceiver. Place the transceiver on a hard, flat, stable surface. Avoid heating vents and window locations that could expose the transceiver to excessive direct sunlight, especially in hot climates.

SAFETY PRECAUTIONS

Electromagnetic Compatibility and RF Exposure

If this transceiver is used with or in the vicinity of a computer or computer-driven accessories, you may need to experiment with grounding and/or radio frequency interference (RFI) suppression devices (such as ferrite cores) to minimize interference to your communications caused by energy leakage from the computer.

Although there is negligible radio frequency (RF) leakage from the **VX-1400** transceiver itself, its antenna system should be located as far away from humans and animals as practicable, so as to avoid the possibility of shock due to accidental contact with the antenna or excessive long-term exposure to RF energy.

Preliminary Inspection

Inspect the transceiver visually immediately upon opening the packing carton. Confirm that all controls and switches work freely, and inspect the cabinet for any damage. Gently shake the transceiver to verify that no internal components have been shaken loose due to rough handling during shipping.

If any evidence of damage is discovered, document it thoroughly and contact the shipping company (or your local dealer, if the unit was purchased over-the-counter) so as to get instructions regarding the prompt resolution of the damage situation. Be certain to save the shipping carton, especially if there are any punctures or other evidence of damage incurred during shipping; if it is necessary to return the unit for service or replacement, use the original packing materials but put the entire package inside another packing carton, so as to preserve the evidence of shipping damage for insurance purposes.

INSTALLATION

POWER REQUIREMENTS AND BASIC INSTALLATION

DC Power Connections

The **VX-1400** transceiver is designed for operation from 13.8 Volts DC, negative ground, with the DC source being capable of providing 23 Amperes of continuous current.

For mobile applications, the fused (25-A) DC cable supplied with this transceiver may be used for making the power connections. Be absolutely certain to observe the proper polarity when making power connections:

The **RED** DC power lead connects to the **Positive (+)** DC terminal; and the **BLACK** DC power lead connects to the **Negative (-)** DC terminal.

To minimize noise pickup, and to provide the best input voltage stability for your transceiver, we recommend you connect the DC cable directly to the vehicle battery, rather than to the ignition or accessory circuitry. Route the DC cable as far away from ignition cables as possible, and cut off any extra cable (from the battery end) to minimize voltage drop. If the DC cable is not long enough, use #12 AWG (minimum) stranded, insulated wire to extend it. Be absolutely certain to solder the connections at the splice securely, and provide ample insulation for the soldered splice (heat shrink tubing plus black electrical tape work well).

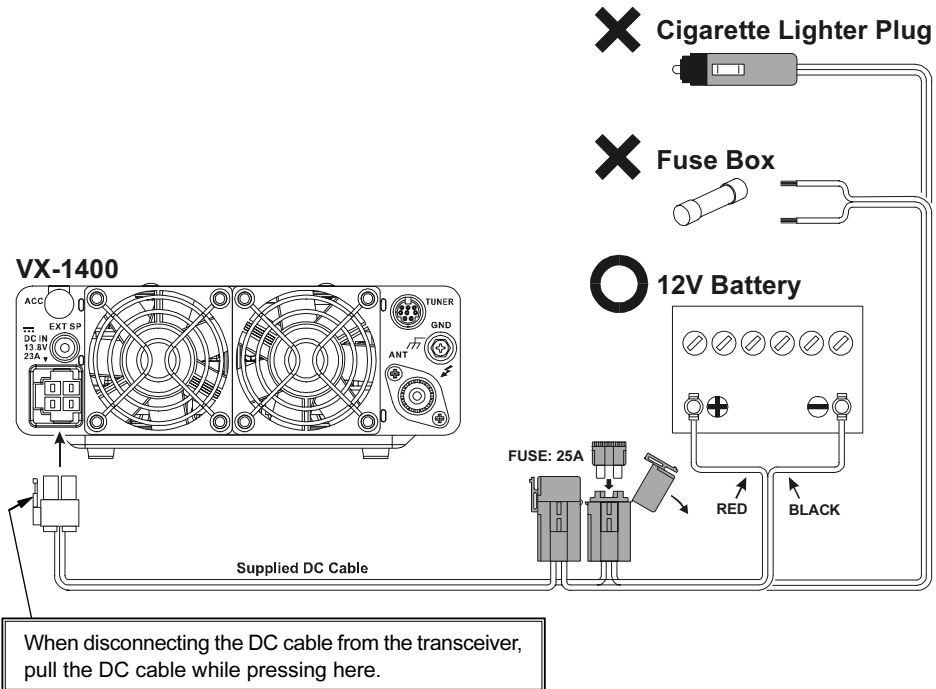

POWER REQUIREMENTS AND BASIC INSTALLATION

Use the following procedure to connect the DC cable:

- ❑ Before connecting the DC cable to the battery, measure the voltage across the battery terminals with the engine running fast enough to show a charge. If the voltage is above 15 Volts, the vehicle's voltage regulator should be adjusted to reduce the charging voltage below 14 Volts.
- ❑ With the radio end of the cable disconnected, connect the **RED** cable lead to the **POSITIVE** battery terminal, and the **BLACK** cable lead to the **NEGATIVE** battery terminal. Make certain that the battery terminal connections are tight, and remember to check them periodically for signs of loosening and/or corrosion.
- ❑ Make sure the **POWER** switch on the **VX-1400** transceiver is off, and plug the DC cable into the **INPUT** jack on the rear panel of the transceiver.

CAUTION! In mobile installations, check to ensure that the transceiver **POWER** switch is turned off whenever starting or stopping the engine, to avoid potential damage from switching transients.

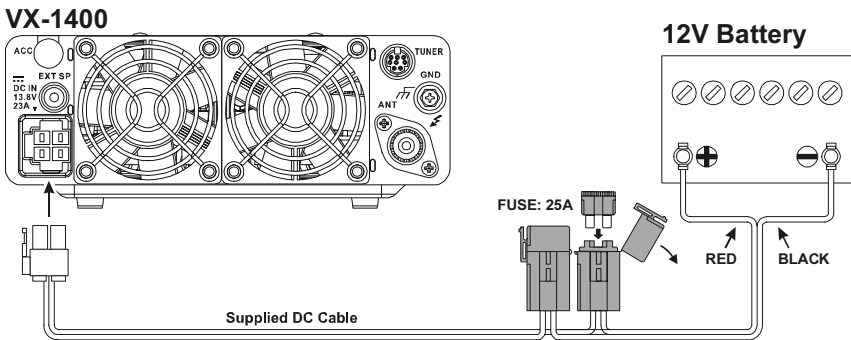

INSTALLATION

MOBILE MOUNTING

The optional **MMB-92** Mobile Mounting Bracket allows quick insertion and removal of the **VX-1400** transceiver from the vehicle. Complete installation instructions are provided with the bracket.

Mobile Antenna Considerations

The **VX-1400** transceiver is designed for use with any antenna system providing a 50-Ohm resistive impedance at the desired operating frequency. While minor excursions from the 50-Ohm specification are of no consequence, the power amplifier's protection circuitry will begin to reduce the power output if there is more than a 50% divergence from the specified impedance (less than 25 Ohms or greater than 100 Ohms, corresponding to a Standing Wave Ratio (SWR) of 2.0:1). Compliance with this specification critically depends on the range of frequencies on which operation will take place, and the design of the antenna(s) in use.

If your mobile or marine operation requires wide frequency coverage, the optional **YA-007FG** (Frequency range is 7 MHz - 30 MHz) or similar mobile whip antenna may be used in conjunction with the optional **FC-40** External Antenna Tuner. The **FC-40** is designed to accommodate a wide variety of whip impedances at the operating frequency, converting these to the desired 50 ohm impedance via a sophisticated microprocessor-controlled impedance matching circuit. The **FC-40** and **VX-1400** provide memory of antenna matching settings sufficient for all channels on Memory Bank 1. In marine applications, the **FC-40** is also ideal for the use with a "backstay" antenna or marine mobile whip.

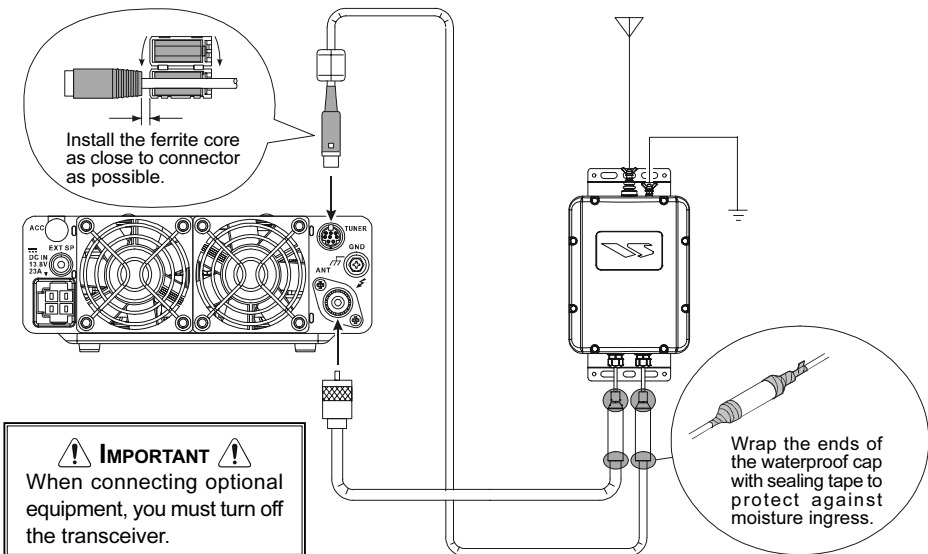

MOBILE MOUNTING

The **FC-40** should be located at or near the base of the antenna, so as to minimize losses and stray radiation. The short lead-in wire from the whip must be securely bonded both to the **FC-40** and the antenna (whip or wire), and the **FC-40** must be securely bonded to the vehicle or vessel ground system, which will act as a counterpoise for the **FC-40** and antenna radiating element. Be sure to weatherproof all outdoor connections thoroughly, especially in maritime environments.

Complete the installation by connecting the RF coaxial cable and **FC-40** control cable as shown in the pictorial below. Complete installation instructions are found in the **FC-40** Instruction Manual; follow the manufacturer's installation instructions when using a whip antenna other than the **YA-007FG**.

For extending the operating frequency range of an antenna fed with coaxial cable, the optional **FC-30** Antenna Tuner may also be used. The impedance matching range of the **FC-30** is from 17 Ohms to 150 Ohms. Interconnection guidelines may be found in the Operating Manual for the **FC-30**.

! IMPORTANT !
When connecting optional equipment, you must turn off the transceiver.

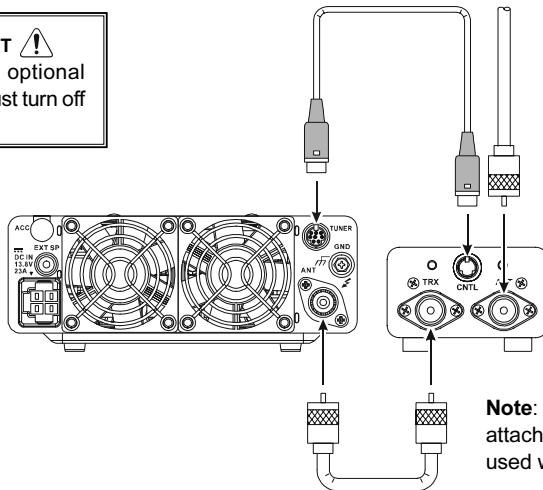

Note: The Mounting Bracket attached to the **FC-30** is not used with the **VX-1400**.

INSTALLATION

MOBILE MOUNTING

Mobile Station Grounding

Although satisfactory grounding in most installations will be achieved via the DC cable's negative lead and the antenna system's coaxial cable shield, it may be necessary, in some installations, to provide a direct ground connection at the mounting location of the transceiver. Due to unexpected resonances which may naturally occur in any location, improper communication system performance may result from insufficient grounding. These symptoms may include: RF feedback (resulting in distortion of your transmitted signal), unintended scanning, blinking or blanking of the frequency display, or loss of memory.

Note that these conditions may occur in any communications installation. The **VX-1400** includes extensive filtering designed to minimize the chance of such problems; however, random currents set up by insufficient RF grounding can nullify such filtering. Bonding the rear panel **GND** terminal of the **VX-1400** transceiver to the vehicle or vessel's ground system should clear up any such difficulties.

Vertex Standard does not recommend the use of "on glass" mobile antennas unless the shield of the coaxial cable is securely grounded near the feedpoint of the antenna. Such antennas frequently are responsible for the ground-related difficulties described above.

BASE STATION INSTALLATION

DC Power Connections

For base station installations, Vertex Standard recommends the use of the optional **FP-1030A** AC Power Supply. The **FP-1030A** provides a regulated 13.8 V DC supply at up to 25-Ampere.

Other models of DC power supplies may be used with the **VX-1400**, but the 13.8 V DC input voltage, 23-Ampere current capability, and DC cable polarity guidelines described previously must be strictly followed.

- ❑ If you are connecting the **FP-1030A** with the **VX-1400** for the first time, before connecting power check the label in the rear of the **FP-1030A** which indicates the AC mains voltage for which the supply is currently set.

CAUTION! Permanent damage can result if improper supply voltage is applied to this transceiver. Your warranty does not cover damage caused by application of AC, reversed polarity DC, or DC outside of the specified range of 13.8 V \pm 15%. If using a power supply other than the **FP-1030A**, ensure that the DC supply connector to the transceiver matches the **VX-1400** wiring configuration. Other manufacturers may utilize power supplies with a physically matched connector that is wired differently; this will cause serious damage to the **VX-1400** transceiver!

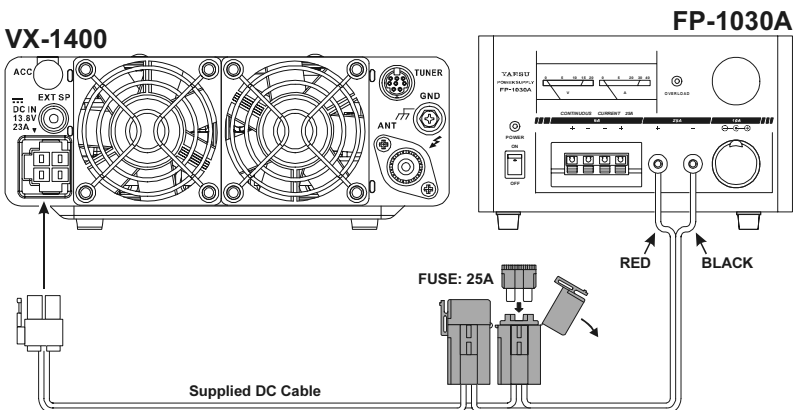

Base Station Antenna Considerations

As with mobile or maritime installations, antenna performance is critical to base station communications system effectiveness. Every effort must be made to ensure that the impedance of the antenna system utilized with the **VX-1400** is as close as practicable to the specified 50-Ohm impedance value, and that mechanical and electrical component integrity are maintained at all times.

For wide frequency range applications, Vertex Standard's Model **YA-30** Broadband Dipole Antenna may be ideal for your communication requirements. Covering an operating frequency range of 1.6-30 MHz, the **YA-30** eliminates the need for multiple antennas which might otherwise be required for equivalent frequency coverage.

The type of antenna required for a particular communications distance will vary. A complete discussion of this topic is beyond the range of this manual; however, a few general guidelines will be offered herewith.

Any antenna to be installed should be free of nearby obstructions which might interfere with its radiation pattern. The antenna, its support structure, and its cables must never be installed in such a manner that would allow them to contact with power or telephone lines in the event of a catastrophic windstorm or other cause of major failure. An adequate safety is usually provided by keeping the antenna and its support structure 1.5 times the height of the support plus the length of any antenna or guy wires attached to the support.

When installing a balanced antenna such as a dipole, remember that the **VX-1400** transceiver is designed for use with an (unbalanced) coaxial feedline. Always use a balun or other balancing device so as to ensure proper antenna system performance.

Vertical antennas usually provide excellent coverage beyond about 1000 km (600 miles), but very poor coverage at closer distances. Horizontal antennas are frequently better for shorter distances, but they may require a stout support structure such as a tower. The height of the horizontal antenna, and the nature of the ground below it, have a profound impact on the favored launch angle for the main radiation lobe from the antenna at a particular frequency. For example, at 6 MHz a horizontal dipole 10 meters high (33 feet) will provide excellent local coverage out to about 500 km (300 miles); however, at the same frequency the dipole would have to be much higher (perhaps 50 meters or 165 feet) for satisfactory communication over a range of 3000 km (1800 miles). On the other hand, at 26 MHz the same

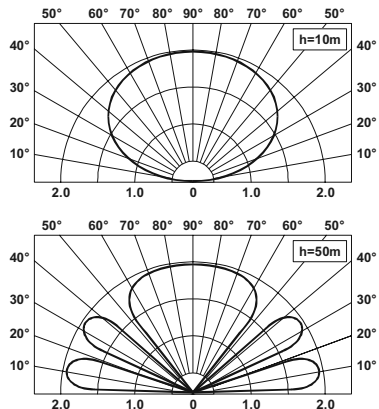

BASE STATION INSTALLATION

dipole at a height of 10 meters could, ionospheric propagation conditions permitting, be expected to provide outstanding performance over the same 3000 km distance.

Excellent reference texts and computer software are available for the design and optimization of HF antennas. Your dealer or installer should be able to assist you with all aspects of your antenna installation.

Use high-quality coaxial cable for the lead-in to your **VX-1400** transceiver. All efforts at providing an efficient antenna system will be wasted if poor quality, lossy coaxial cable is used. Losses in coaxial lines increase as the frequency increases, so a coaxial line with 0.5 dB of loss at 6 MHz may have 2 dB of loss at 26 MHz (1 dB is a just-perceptible decrease in signal strength). As a general rule, smaller-diameter coaxial cables tend to have higher losses than larger-diameter cables, although the precise differences depend critically on the cable construction, materials, and the quality of the connectors used on the cable. See the cable manufacturers' specifications for details.

For reference, the chart below shows approximate loss figures for typically-available coaxial cables frequently used in HF installations.

Loss in dB per 30 m (100 ft) for Selected 50 Ohms Coaxial Cables
(ASSUMES 50 OHMS INPUT/OUTPUT TERMINATIONS)

CABLE TYPE	Loss		
	2 MHz	15 MHz	28 MHz
RG-58A	0.55	1.75	2.60
RG-58 Form	0.54	1.50	2.00
RG-8X	0.39	1.07	1.85
RG-8A, RG-213	0.27	0.85	1.25
RG-8 Form	0.22	0.65	0.88
Belden® 9923	0.18	0.50	0.69
RG-17A	0.08	0.30	0.46

- Loss figures are approximate; consult cable manufacturers' catalog for complete specifications.
- Loss figures can increase significantly if high SWR is present on the transmission line.

INSTALLATION

BASE STATION INSTALLATION

Base Station Grounding

The **VX-1400** HF transceiver, like any other HF communications apparatus, requires an effective ground system for maximum electrical safety and best communications effectiveness. A good ground system can contribute to station efficiency in a number of ways.

- It can minimize the possibility of electrical shock to the operator.
- It can minimize RF currents flowing on the shield of the coaxial cable and the chassis of the transceiver which may cause interference to nearby home entertainment devices or laboratory test equipment.
- It can minimize the possibility of erratic transceiver operation caused by RF feedback or improper current flow through logic devices.

An effective earth ground system may take several forms; for a more complete discussion, see an appropriate RF engineering text. The information presented below is intended only as a guideline.

BASE STATION INSTALLATION

Typically, the ground connection consists of one or more 2.4 m (8') copper-clad steel rods, driven into the ground. If multiple ground rods are used, they should be configured in a "V" configuration, and bonded together at the apex of the V which is nearest the station location. Use a heavy, braided cable (such as the discarded shield from type RG-213 coaxial cable) and strong cable clamps to secure the braided cables to the ground rods. Be sure to weatherproof the connections to ensure many years of reliable service. Use the same type of heavy, braided cable for the connections to the station ground bus (described below).

Inside the station, a common ground bus consisting of a solid copper pipe of at least 25mm (1") diameter should be used. Another ideal ground bus may consist of a wide copper plate (single-sided circuit board material is ideal) secured to the bottom of the operating desk. Grounding connections from individual devices such as transceivers, power supplies, and data communications devices should be made directly to the ground bus using a heavy, braided cable.

Do not make ground connections from one electrical device to another, and thence to the ground bus. This so-called "Daisy Chain" grounding technique may nullify any attempt at effective radio frequency grounding. See the drawings below for examples of proper and improper ground connections.

Inspect the ground system - inside the station as well as outside - on a regular basis so as to ensure maximum performance and safety.

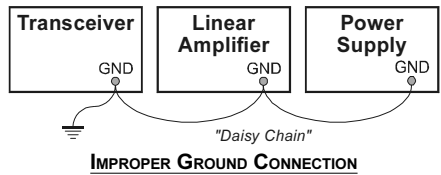
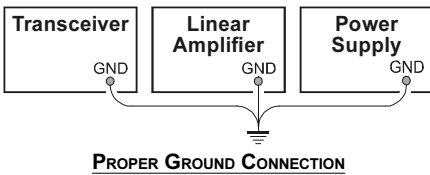

OPERATION

TURNING THE TRANSCEIVER “ON” AND “OFF”

- ❑ Be certain that all power supply, antenna, ground, microphone, and other accessory connections have been properly accomplished.
- ❑ Rotate the **VOL** knob fully counter-clockwise.
- ❑ Press and holding in the [**POWER**(☉)] switch until the LCD display is illuminated.
- ❑ To turn the radio off, press and holding in the [**POWER**(☉)] switch until the LCD display is disappeared.

RECEPTION

- ❑ Rotate the **VOL** knob for a comfortable listening level on the incoming signals or noise present on the speaker.
- ❑ When no signal is present on the channel, press the [**SQL**] button (the [**PROGRAMMABLE**] button which assigns the “Squelch” function: the factory default is [**P2**] button) to activate the “Squelch Adjusting” mode, then press the [▼]/[▲] button to the point where the background noise is just silenced; finally press the [**P2**] button again.

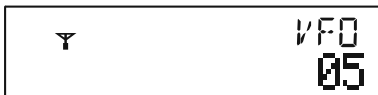

Unless you are responsible for listening for very weak signals (very near the background noise), silencing the receiver using the circuitry is usually preferable in most applications.

- ❑ When a signal strong enough to override the squelch threshold is received, the incoming signal will be heard in the speaker, and the **TX/BUSY** indicator glows green. When the incoming signal is disappeared, the green **TX/BUSY** indicator will disappear.
- ❑ When a signal is being received, the S/PO meter will become illuminated according to the incoming signal strength. You may use this S/PO meter reading to compare communications path effectiveness on different channels, or to assist with optimum antenna rotation, if a directional antenna is being used.

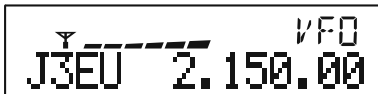

- ❑ When receiving an impulse noise, such as that from a power line or a vehicle, press the [**NB**] button (the [**PROGRAMMABLE**] button which assigns the “Noise Blanker” function: the factory default is [**S2**] button) to reduce the noise level. When the noise blanker is activated, the “⊗” icon will be illuminated. Press the [**NB**] button again to disable the noise blanker.

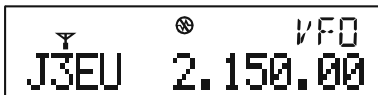

- ❑ If the station you are listening to should drift or otherwise be unclear (the voice may sound too high-pitched or too low-pitched), press the [**CLAR**] button (the [**PROGRAMMABLE**] button which assigns the “Clarifier” function: the factory default is the [**P3**] button) to activate the “Clarifier” function. The offset



RECEPTION

frequency (receive frequency vs transmission frequency) will appear on the display.

- ❑ Press the [◀]/[▶] (move the digit) and [▼]/[▲] (select the number) button to improve the sound of the incoming signal. These buttons functions does not affect your transmission frequency; only the receive frequency is being adjusted (up to ± 1.000 kHz). Press and hold in *both* [▼] and [▲] buttons for one second to reset the offset.



Important Note: The transceiver can not transmit while adjusting the clarifier offset. If you wish to transmit, press the [CLAR] button again to return to normal display.

- ❑ Press the [CLAR] button again to return to normal display. When the receiving frequency is higher than displayed frequency, the “▲” icon will appear in the upper side of the frequency display. Similarly, when the receiving frequency is lower than displayed frequency, the “▼” icon will appear in the upper side of the frequency display.



Important Note: Keep offset frequency until you change the operating frequency or reset the offset by pressing and holding *both* [▼] and [▲] buttons for one second.

- ❑ If the LCD display is too bright, press the [DIM] button (the [PROGRAMMABLE] button which assigns the “Dimmer” function: the factory default is [S1] button) to reduce the display brightness. Press the [DIM] button again return to the LCD display to nominal brightness level.
- ❑ Press the Programmable Function ([P0] ~ [P4], [S1] & [S2]) buttons to activate the function which is corresponding with that button. Refer to page 42 for the details of the Programmable Function button.

OPERATION

FREQUENCY AND CHANNEL SELECTION

The **VX-1400** includes the following frequency selection capabilities:

- A VFO (Variable Frequency Oscillator) System
- Memory Channel
- ITU Marine Channel

- **In the VFO mode**, the frequency is displayed on the right side, with the operating mode on the left side of the display.

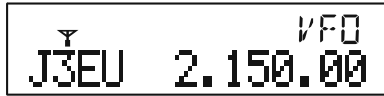

A rectangular display box showing the VFO mode. On the left, there is a small antenna icon above the text 'J3EU'. In the center, the frequency '2.150.00' is displayed. On the right, the text 'VFO' is displayed above the frequency.

- **In the Memory Channel Mode**, the frequency is displayed on the right side, and the memory channel number is displayed on the left side of the display with the memory bank number at the upper right corner of the display. Therefore, in the example at the right, the display is indicating Channel #5 on Memory Bank #1.



A rectangular display box showing the Memory Channel Mode. On the left, there is a small antenna icon above the text '005'. In the center, the frequency '6.215.00' is displayed. On the right, the text 'M 1' is displayed above the frequency.

- **In the ITU mode**, the frequency and memory channel number are displayed as they are during Memory Channel Mode; however, the upper right corner of the display indicates the "ITU" which indicate ITU Marine Channel designator.

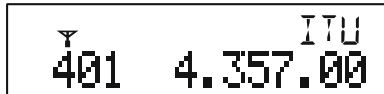

A rectangular display box showing the ITU mode. On the left, there is a small antenna icon above the text '401'. In the center, the frequency '4.357.00' is displayed. On the right, the text 'ITU' is displayed above the frequency.

Frequency and channel selection are very simple on the **VX-1400**:

Select the desired channel grouping (VFO, Memory Channel, and ITU) by pressing the [◀]/[▶] button. The circulation of channel groups is "VFO" ↔ "Memory Bank 1" ↔ "Memory Bank 2" ↔ "Memory Bank 3" ↔ "Memory Bank 4" ↔ "Memory Bank 5" ↔ "ITU" ↔ "VFO"

FREQUENCY AND CHANNEL SELECTION

VFO Mode

- ❑ Press the [▼]/[▲] button to select the operating frequency.
- ❑ If the tuning rate is too slow or too fast, the frequency synthesizer steps may be changed by the following procedures:
 - 1) Press the [STEP] button (the [PROGRAMMABLE] button which assigns the “Step” function: the factory default is [P0] button) briefly to enable changing the frequency digit of the synthesizer step.
 - 2) Press the [◀]/[▶] button to select the frequency digit which enable selecting the operating frequency.
 - 3) Press the [STEP] button briefly again to save the new setting and exit to normal operation.
- ❑ If you need to change the operating mode, press the [MODE] button (the [PROGRAMMABLE] button which assigns the “Mode” function: the factory default is [P4] button). Available operating modes are J3EU (USB), J3EL (LSB), J2BU (USB), A1A (CW), and A3E (AM).
- ❑ If you use the optional **MH-77** Hand Microphone, the microphone’s [UP] or [DWN] key may also be used to select the operating frequency. Pressing the [UP] or [DWN] button briefly will cause the operating frequency to increment or decrement one step, respectively. Pressing and holding the [UP] or [DWN] key in for 1/2 second will initiate upward or downward scanning, respectively. Releasing the [UP] or [DWN] key halts the scan.
- ❑ The optional **MH-77** Hand Microphone may be entered the VFO frequency directly.
 - Press the Microphone’s [ENT] key (the keypad’s key which assigned “Entry Command” function) briefly, then enter seven digits (from 10 MHz digit to 10 Hz digit) of the desired receiving frequency. If you make a mistake during frequency entry, Press the [◀]/[▶] button so as to cause the erroneous digit of the frequency to blink; now, press the correct number on the keypad, and continue with the remainder of the frequency entry process.
 - Press the [ENT] key briefly, then enter seven digits (from 10 MHz digit to 10 Hz digit) of the desired transmit frequency by a same procedures as entering the receiving frequency if you wish to store independent transmit and receive frequencies on the same channel. Otherwise, skip to the next step.
 - Press the [ENT] key again to finalize the entry of the VFO frequency (frequencies).

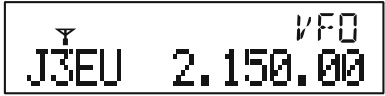

OPERATION

FREQUENCY AND CHANNEL SELECTION

Memory Channel Mode

- Press the [▼]/[▲] button to select the desired Memory Channel within the selected Memory Bank. Remember that there are a total of five Memory Banks, so if you do not find a particular channel, it may have been stored in a different Memory Bank.
- If you use the optional **MH-77** Hand Microphone, the microphone's [UP] and [DWN] keys may also be used to select the Memory Channel. Pressing the [UP] or [DWN] key briefly will cause the Memory Channel to increment or decrement one step, respectively. Pressing and holding the [UP] or [DWN] key in for 1/2 second will initiate upward or downward scanning on the Memory Channels, respectively. Releasing the [UP] or [DWN] key halts the scan.



The LCD display shows the selected Memory Channel as 005, the frequency as 6.215.00, and the Memory Bank as M 1.

ITU Marine Channel

- Press the [▼]/[▲] button to select the desired ITU Memory Channel within the standard ITU Marine Channel Bank provided. The operating mode is automatically selected, and can not be changed.
- If you use the optional **MH-77** Hand Microphone, the microphone's [UP] and [DWN] keys may also be used to select the ITU Memory Channel. Pressing the [UP] or [DWN] key briefly will cause the ITU Memory Channel to increment or decrement one step, respectively. Pressing and holding the [UP] or [DWN] key in for 1/2 second will initiate upward or downward scanning on the ITU Memory Channels, respectively. Releasing the [UP] or [DWN] key halts the scan.



The LCD display shows the selected ITU Marine Channel as 401, the frequency as 4.357.00, and the mode as ITU.



TRANSMISSION

- ❑ For Voice transmission, close the **PTT** (Push To Talk) switch on the microphone; the transmitter will now be activated and the **TX/BUSY** indicator glows red. Hold the microphone about 1 inch (25 mm) from your mouth, and speak into the front of the microphone in a normal voice level. Release the **PTT** switch to return to the receive mode (the red **TX/BUSY** indicator will disappear).
- ❑ For CW (Morse Code telegraphy) in the A1A mode, begin sending using your telegraph key or electronic keyer. The **VX-1400** will automatically be placed in the transmit mode when you start to send, and will revert to the receive mode when you stop sending. As you send, a “Sidetone” audio generator allows you to monitor your sending.
- ❑ For Data transmission (including Morse Code telegraphy using a TNC (Terminal Node Controller) and keyboard, or similar computer-driven data transmission devices), transmit/receive control is exercised by the software which accompanies the data transmission equipment in use. See the User’s Manual for your terminal equipment for operating instructions. Remember to follow the maximum power output guidelines during continuous-duty operation such as RTTY (Radio Teletype) in the J2B mode. Adjust the TX Audio level from the TNC for a maximum of 50 Watts of power output (4 segments illuminated on the Power Output Bar Graph) if long periods of continuous transmission are anticipated.



Note: The CW and Data transmission requires optional **CT-139** Accessory Cable.





Antenna Tuning Procedures

When the optional **FC-30** or **FC-40** External Antenna Tuner is installed, it is activated on each channel automatically.

- Be certain that all connections to the **FC-30/-40** have been properly made.
- Select the appropriate channel with the [▼]/[▲] button.
- Press the [TUNER] button (the [PROGRAMMABLE] button which assigned “TUNER” function: the factory default is the [P1] button). The two arrows of “” icon on the LCD display will blink, and the **VX-1400** will transmit for a short time. Thereafter, the transceiver will return to the receive mode, and the “” icon will now be illuminated constantly.
- The **FC-30/-40**’s microprocessor-based circuitry includes memory sufficient to retain 100 (for **FC-30**, 200 for **FC-40**) antenna tuning settings in memory. This will greatly reduce frequency change time. If you utilize more than 100 or 200 operating channels that are widely removed in frequency, the new tuning settings will be overwritten on a first-in, first-out basis.

IMPORTANT NOTE

If the impedance encountered by the **FC-30/-40** exceeds 2:1, the “” icon will blink, and the microprocessor will not retain the tuning data for that frequency, as the **FC-30/-40** presumes that you will want to adjust or repair your antenna system so as to correct the high SWR condition. Similarly, when the temperature of the inside of the transceiver’s case becomes higher, the “” icon will also blink. Stop the transmission and cool down the transceiver for few minutes.

ICON	STATUS
	Normal Condition
 (w/Blink)	Hi SWR or Hi Temperature
	Antenna Tuner is activated
 (w/▶ ◀Blink)	Antenna Tuner is progressing

DUAL WATCH

The Dual Watch feature allows the user or dispatcher to operate on one channel while periodically making a brief check of Memory Channel “1-001” (Memory Bank #1, Channel #1). The Dual Watch feature can be engaged so long as there is frequency and mode data written into memory channel “1-001”.

Every four seconds, the transceiver will automatically switch over to memory channel “1-001”. If a station is transmitting on memory channel “1-001”, the transceiver will hold on memory channel “1-001” for five seconds, then Dual watch operation will resume (irrespective of the transmit/receive status of any stations on memory channel “1-001”).

Dual Watch operation is simple to use. Follow these steps:

- Adjust the squelch circuit so that the green **TX/BUSY** indicator disappears and the receiver is silenced.
- Press the **[DW]** button (the **[PROGRAMMABLE]** button which assigned “Dual Watch” function) to activate Dual Watch. After four seconds, the transceiver will switch over to memory channel “1-001,” and will stay there for 1/2 seconds, thereafter returning to your original channel. The “**DW**” icon will become illuminated while the Dual Watch feature is activated.
- If a call is received on memory channel “1-001” during Dual Watch operation, the transceiver will hold on memory channel “1-001” for five seconds, then Dual watch operation will resume (irrespective of the transmit/receive status of any stations on memory channel “1-001”). The “**DW**” icon will blink while receiving the memory channel “1-001”.
- Press the **[DW]** button again to disable the Dual Watch feature. The “**DW**” icon disappears and operation will revert to your original operating frequency.
- Note that your main operating channel can be changed during Dual Watch operation, but you cannot change channels while memory channel “1-001” is being checked for activity.

OPERATION

ENCRYPTED TRANSMISSION / RECEPTION (REQUIRES OPTIONAL ENCRYPTION UNIT)

- ❑ If the transceivers you (and others in your communication group) are using are equipped with the optional Encryption Unit, the Encryption mode may be activated by pressing the [**ENCRP**] button (the [**PROGRAMMABLE**] button which assigned “Encryption” function). The “” icon will become illuminated.
- ❑ To de-activate encryption, press the [**ENCRP**] button.
- ❑ If the signals of all the other stations in your communications group have a severely distorted or “scrambled” sound, you may have accidentally de-activated your transceiver’s encryption mode. Pressing the [**ENCRP**] button may allow recovery. However, if only one station in your communications group sounds distorted or “scrambled,” it is possible that the encryption mode of that transceiver may have been accidentally turned off. Either the dispatcher or you may advise the other station by switching your encryption off and calling the other station in the non-encrypted mode. Remember that your transmissions will be sent in a non-encrypted format, and will thus not be secure; limit your discussion to a brief advisory regarding the [**ENCRP**] button on the other station’s transceiver, then revert to encrypted operation immediately by pressing the [**ENCRP**] button on your transceiver.

2.182 MHz EMERGENCY CHANNEL MODE

If the [S1] and [S2] buttons was assigned to “ALARM” and “2182” functions by your VERTEX STANDARD dealer, the **VX-1400** is specialized to marine version which provides several important operational benefits for the marine owner.

- ❑ Pressing the [2182] ([S2]) button automatically switches the transceiver to the Marine Distress Channel, 2182 kHz (2.182 MHz), and also places the transceiver in the H3E (Single-Sideband AM) mode. On the display, the frequency “2.182.00” will be displayed, and the upper right corner of the display indicates the “EMG” which indicate Emergency Channel operation.
- ❑ If desired, the operating mode may be changed to J3EU (USB) by pressing the [P4] button.
- ❑ The [ALARM] ([S1]) button may be used for sending a distress signal. To test the alarm, just press the [ALARM] ([S1]) button briefly. After one second, an audible alarm will be heard, although no transmission occurs. Press the [ALARM] ([S1]) button again to stop the test alarm.
- ❑ In an Emergency, press the [2182] ([S2]) button while pressing and holding in the [ALARM] ([S1]) button. This **VX-1400** will transmit the international marine distress signal (alternating 1300 Hz and 2200 Hz tones) for 35 seconds. Press the [ALARM] ([S1]) button (not the [2182] ([S2]) button) to cancel the transmitted distress signal.
- ❑ Press the [2182] ([S2]) button again to exit the 2.182 MHz Emergency Channel Mode.
- ❑ Be certain your operators and crew understand the function of the 2182 Alarm feature, and make sure they understand that it is only to be used in case of a true emergency situation.

SELCALL/TELCALL OPERATION

GENERAL

The **VX-1400**'s Selcall feature provides six calling modes:

- **Selcall**

The Selcall mode allows you to make an individual/group call using the individual ID (Identification) number assigned for each transceiver.

- **Message Call**

The Message Call mode allows you to send a text message (up to 64 characters of text) to another station.

- **Position Request Call**

The Position Request Call mode allows you to request the position information of another station.

- **Position Send Call**

The Position Send Call mode allows you to send your own position information to another station.

- **Beacon Request Call**

The Beacon Request Call mode allows you to inquire as to the signal quality between your transceiver and another specific transceiver (before making an individual/group call).

- **TelCall**

The TelCall mode allows you to make a telephone call through a telephone interconnect service provider.

SELCALL

The Selcall mode allows you to make an individual/group call using an individual ID (Identification) assigned to each transceiver in your group or fleet.

Preparation

- ❑ Press the [▼]/[▲] button to select the channel to be used for Selcall.
- ❑ Disable the VOX and Clarifier features, if necessary.
- ❑ Press the [SELCALL] button (the [PROGRAMMABLE] button which assigned “Selcall” function) briefly to activate the Selcall system. The “SEL” icon will be illuminated on the LCD display.

Sending a Selcall

- ❑ Press the [CALL] button (the [PROGRAMMABLE] button which assigned “Call” function), then press the [▼]/[▲] button to select the ID number of the station to be called using Selcall. Available IDs are: the last-received ID, ten pre-programmed IDs, and “Auxiliary,” whereby you enter the desired ID using the Allow ([▼]/[▲]/[◀]/[▶]) buttons. To enter the desired ID, press the [▼]/[▲] button to select “AUX ID”, press the [▶] button, then enter the 4-digit ID number by the [◀]/[▶] (move the cursor) and the [▼]/[▲] (select number) buttons; finally press the [CALL] button again.
- ❑ Press the [CALL] button briefly to enter the Call Menu.
- ❑ Press the [▼]/[▲] button to select “SELCALL”.
- ❑ Press the [CALL] key again to transmit the Selcall.

Receiving a Selcall

- ❑ When the **VX-1400** receives a Selcall matching your individual ID, a bell alarm will be heard, and the LCD will display the received (calling station’s) ID number.
- ❑ Press the **PTT** switch momentarily to cancel the Selcall, then press and hold in the PTT switch and speak into the microphone in the usual fashion to reply to the Selcall.
- ❑ Press the [SELCALL] key again to re-activate the Selcall system.

SELCALL/TELCALL OPERATION

MESSAGE CALL

The Message Call mode allows you to send a text message (up to 64 characters of text) to a specific station.

Preparation

- Press the [▼]/[▲] button to select the channel to be used for Message Call.
- Disable the VOX and Clarifier features, if necessary.
- Press the [SELCALL] button (the [PROGRAMMABLE] button which assigned “Selcall” function) briefly to activate the Selcall system. The “**SEL**” icon will be illuminated on the LCD display.

Sending a Message Call

- Press the [CALL] button (the [PROGRAMMABLE] button which assigned “Call” function), then press the [▼]/[▲] button to select the ID number of the station to be called using Selcall. Available IDs are: the last-received ID, ten pre-programmed IDs, and “Auxiliary,” whereby you enter the desired ID using the Allow ([▼]/[▲]/[◀]/[▶]) buttons. To enter the desired ID, press the [▼]/[▲] button to select “AUX ID”, press the [▶] button, then enter the 4-digit ID number by the [◀]/[▶] (move the cursor) and the [▼]/[▲] (select number) buttons; finally press the [CALL] button again.
- Press the [CALL] button briefly to enter the Call Menu.
- Press the [▼]/[▲] button to select “MESSAGE.”
- Press the [CALL] button again to display the last transmitted message. Press the [▼]/[▲] button to select the message which you want to transmit. Available messages are three pre-programmed messages and “Auxiliary”, whereby you enter the desired message using the Allow ([▼]/[▲]/[◀]/[▶]) buttons. To enter the desired message, press the [▼]/[▲] button to select “AUX”, press the [▶] button, then enter the message by the [◀]/[▶] (move the cursor) and the [▼]/[▲] (select number) buttons. A total of 64 characters may be used in the message.
- Press the [CALL] button again to transmit the Message Call.

Receiving a Message Call

- When the **VX-1400** receives a Message Call matching your individual ID, a bell alarm will be heard, and the “ Press the **PTT** switch momentarily to cancel the Message Call mode, then press and hold in the **PTT** switch and speak into the microphone in the usual fashion to reply to the Message Call.
- Press the [SELCALL] key again to re-activate the Selcall system.

POSITION REQUEST CALL

The Position Request Call mode allows you to request position information from a specific station.

Preparation

- Press the [▼]/[▲] button to select the channel to be used for the Position Request Call.
- Disable the VOX and Clarifier features, if necessary.
- Press the [SELCALL] button (the [PROGRAMMABLE] button which assigned “Selcall” function) briefly to activate the Selcall system. The “SEL” icon will be illuminated on the LCD display.

Sending a Position Request Call

- Press the [CALL] button (the [PROGRAMMABLE] button which assigned “Call” function), then press the [▼]/[▲] button to select the ID number of the station to be called using Selcall. Available IDs are: the last-received ID, ten pre-programmed IDs, and “Auxiliary,” whereby you enter the desired ID using the Allow ([▼]/[▲]/[◀]/[▶]) buttons. To enter the desired ID, press the [▼]/[▲] button to select “AUX ID”, press the [▶] button, then enter the 4-digit ID number by the [◀]/[▶] (move the cursor) and the [▼]/[▲] (select number) buttons; finally press the [CALL] button again.
- Press the [CALL] button briefly to enter the Call Menu.
- Press the [▼]/[▲] button to select “POS REQ”.
- Press the [CALL] button again to transmit the Position Request Call.

Receiving a Position Request Call

- When the **VX-1400** receives a Position Request Call matching your individual ID, the LCD will display the received (calling station’s) ID number; your radio will transmit your current position (Latitude/Longitude) automatically.
- Press the **PTT** switch momentarily to cancel the Position Request Call, if desired.
- Press the [SELCALL] button again to activate the Selcall system.

Note: A suitable GPS receiver capable of supplying NMEA-0183 data must be connected to the GPS port of the optional **CT-139** Accessory Cable in order to transmit your current position. When the transceiver receives the GPS data, the “★” icon will be illuminated on the LCD display.

SELCALL/TELCALL OPERATION

POSITION SEND CALL

The Position Send Call mode allows you to send your own position information to the intended ID station.

Note: A suitable GPS receiver capable of supplying NMEA-0183 data must be connected to the GPS port of the optional **CT-139** Accessory Cable in order to transmit your current position. When the transceiver receives the GPS data, the “★” icon will be illuminated on the LCD display.

Preparation

- Press the [▼]/[▲] button to select the channel to be used for the Position Send Call.
- Disable the VOX and Clarifier features, if necessary.
- Press the [SELCALL] button (the [PROGRAMMABLE] button which assigned “Selcall” function) briefly to activate the Selcall system. The “SEL” icon will be illuminated on the LCD display.

Sending a Position Send Call

- Press the [CALL] button (the [PROGRAMMABLE] button which assigned “Call” function), then press the [▼]/[▲] button to select the ID number of the station to be called using Selcall. Available IDs are: the last-received ID, ten pre-programmed IDs, and “Auxiliary,” whereby you enter the desired ID using the Allow ([▼]/[▲]/[◀]/[▶]) buttons. To enter the desired ID, press the [▼]/[▲] button to select “AUX ID”, press the [▶] button, then enter the 4-digit ID number by the [◀]/[▶] (move the cursor) and the [▼]/[▲] (select number) buttons; finally press the [CALL] button again.
- Press the [CALL] button briefly to enter the Call Menu.
- Press the [▼]/[▲] button to select “POS SND”.
- Press the [CALL] button again to transmit the Position Send Call.

Receiving a Position Send Call

- When the **VX-1400** receives a Position Send Call matching your individual ID, a bell alarm will be heard, and the received (calling station’s) ID number, position (Latitude/Longitude), and time will scroll across the LCD.
- Press the **PTT** switch momentarily to cancel the Position Send Call, then press and hold in the **PTT** switch and speak into the microphone in the usual fashion to reply to the Position Send Call.
- Press the [SELCALL] button again to activate the Selcall system.

BEACON REQUEST CALL

The Beacon Request Call mode allows you to inquire as to the signal quality between your transceiver and another specific transceiver (before placing an individual/group call).

Preparation

- Press the [▼]/[▲] button to select the channel to be used for the Beacon Request Call.
- Disable the VOX and Clarifier features, if necessary.
- Press the [SELCALL] button (the [PROGRAMMABLE] button which assigned “Selcall” function) briefly to activate the Selcall system. The “SEL” icon will be illuminated on the LCD display.

Sending a Beacon Request Call

- Press the [CALL] button (the [PROGRAMMABLE] button which assigned “Call” function), then press the [▼]/[▲] button to select the ID number of the station to be called using Selcall. Available IDs are: the last-received ID, ten pre-programmed IDs, and “Auxiliary,” whereby you enter the desired ID using the Allow ([▼]/[▲]/[◀]/[▶]) buttons. To enter the desired ID, press the [▼]/[▲] button to select “AUX ID”, press the [▶] button, then enter the 4-digit ID number by the [◀]/[▶] (move the cursor) and the [▼]/[▲] (select number) buttons; finally press the [CALL] button again.
- Press the [CALL] button briefly to enter the Call Menu.
- Press the [▼]/[▲] button to select “BCN REQ”.
- Press the [CALL] button again to transmit the Beacon Request Call.
- If the Beacon Request call is successful, the “Answer” signal from the called station will be heard.

SELCALL/TELCALL OPERATION

TELCALL

The Telcall mode allows you to make a telephone call through a telephone interconnect service provider.

Preparation

- ❑ Press the [▼]/[▲] button to select the channel for Tel Call.
- ❑ Disable the VOX and Clarifier features, if necessary.
- ❑ Press the [SELCALL] button (the [PROGRAMMABLE] button which assigned “Selcall” function) briefly to activate the Selcall system. The “SEL” icon will be illuminated on the LCD display.

Sending a TelCall

- ❑ Press the [TELCALL] button (the [PROGRAMMABLE] button which assigned “TelCall” function), then press the [▼]/[▲] button to select the ID number of the station to be called using Telcall. Available IDs are: the last-received ID, ten pre-programmed IDs, and “Auxiliary,” whereby you enter the desired ID using the Allow ([▼]/[▲]/[◀]/[▶]) buttons. To enter the desired ID, press the [▼]/[▲] button to select “AUX ID”, press the [▶] button, then enter the 4-digit ID number by the [◀]/[▶] (move the cursor) and the [▼]/[▲] (select number) buttons; finally press the [TELCALL] button again.
- ❑ Press the [TELCALL] button again to display the last used telephone number, then press the [▼]/[▲] button to select the telephone number which you want to transmit. Available telephone numbers are ten pre-programmed IDs and “Auxiliary”, whereby you enter the desired telephone number using the Allow ([▼]/[▲]/[◀]/[▶]) buttons. To enter the desired telephone number, press the [▼]/[▲] button to select “AUX”, press the [▶] button, then enter the telephone number by the [◀]/[▶] (move the cursor) and the [▼]/[▲] (select number) buttons; finally press the [TELCALL] button again.
- ❑ Press the [TELCALL] button again to transmit the TelCall.
- ❑ When the communication is finished, press the [TELCALL] button while holding in the PTT switch to send the “Hang-up” signal.

SELCALL/TELCALL OPERATION

NOTE

ALE OPERATION (REQUIRES OPTIONAL ALE-2 UNIT)

The **VX-1400**'s ALE (Automatic Link Establishment) feature allows you to select the channel with the best LQA (Link Quality Analysis) score from the programmed channels automatically.

Sending an ALE Call

- Press the [◀]/[▶] button, as needed, to select the Memory Channel mode.
- Press the [ALE] button (the [PROGRAMMABLE] button which assigned “ALE” function) to activate the ALE feature. The **VX-1400** will display the last-activated network and the “ALE” icon will be illuminated on the LCD display. After five seconds from the initial pressing of the [ALE] button, the **VX-1400** will initiate the ALE scanner.
- If you wish to change the current ALE network, press the [▼]/[▲] button to select the desired network.
- Press the [CALL] button (the [PROGRAMMABLE] button which assigned “Call” function) to open the station list.
- Press the [▼]/[▲] button to select the station name to which you wish to direct an ALE Call. Available stations are: the last-received station, 100 pre-programmed stations, and ALL CALL, which is a broadcast message which your radio uses to establish a connection with all other stations simultaneously.
- Press and hold the [CALL] button again to transmit the ALE Call. The “★” icon will blink on the LCD display when the ALE feature is progressing. Thereafter, the “★” icon will be illuminated continuously.

ALE OPERATION (REQUIRES OPTIONAL ALE-2 UNIT)

Sending an ALE Call with an Imbedded Message







- Press the [◀]/[▶] button, as needed, to select the Memory Channel mode.
- Press the [ALE] button (the [PROGRAMMABLE] button which assigned “ALE” function) to activate the ALE feature. The **VX-1400** will display the last-activated network and the “ALE” icon will be illuminated on the LCD display. After five seconds from the initial pressing of the [ALE] button, the **VX-1400** will initiate the ALE scanner.
- If you wish to change the current ALE network, press the [▼]/[▲] button to select the desired network.
- Press the [CALL] button (the [PROGRAMMABLE] button which assigned “Call” function) to open the station list.
- Press the [▼]/[▲] button to select the station name to which you wish to direct the ALE Call. Available stations are: the last-received station, 100 pre-programmed stations, and ALL CALL, which is a broadcast message which your radio uses to establish a connection with all other stations simultaneously.
- Press the [CALL] button, then press the [▼]/[▲] button to select the desired message from the ten pre-programmed messages. If you wish to edit the message:
 - Press the Microphone’s [ENT] key (the keypad’s key which assigned “Entry Command” function), then enter the desired message (up to 90 characters) by pressing the [◀]/[▶] (move the cursor) and the [▼]/[▲] (select character/number) buttons.
 - Press the [ENT] key again to terminate the message.If you select the “None” option, you may send just the ALE Call instead of the ALE Call with the imbedded message.
- Press and hold the [CALL] button to transmit the ALE Call with the imbedded message.

Receiving a ALE Call

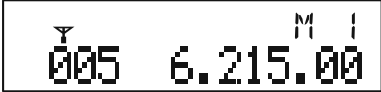
- When the **VX-1400** receives a ALE Call matching your individual ID, a bell alarm will be heard, and the “☒” icon will appear at the top center on the LCD, and the received (called station’s) ID number and the message (if the message is attached to the ALE Call) will scroll across the display.
- Press the [ALE] button to disappear the ID number and the message.

MEMORY CHANNEL STORAGE

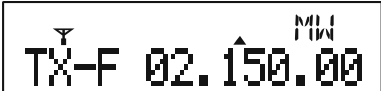
The **VX-1400** allows the user or dispatcher to store the frequency and operating mode into the desired Memory Bank.

- Press the [**◀**]/[**▶**] button to recall the Memory Bank which wants to store the data. 
- Press the [**MW**] button (the [**PROGRAMMABLE**] button which assigned “Memory Write” function); on the LCD you will see a blinking memory channel number. 
- Press the [**▼**]/[**▲**] button to select the Memory channel onto which you wish to store new frequency information. If you select a channel on which data is already stored, entering new data will cause you to overwrite the data previously stored. 
- Press the [**MW**] button, then enter seven digits (from 10 MHz digit to 10 Hz digit) of the desired receiving frequency by pressing the [**◀**]/[**▶**] (move the cursor) and the [**▼**]/[**▲**] (select number) buttons. 
- Press the [**MW**] button, then press the [**▼**]/[**▲**] button to select the desired operating mode. Available operating modes are “J3E-USB”, “J3E-LSB”, “J2B-USB”, “A1A”, and “A3E”. 
- Press the [**MW**] button. If your radio assign the CLAR function to the Programmable Function (**P0 ~ P4**) buttons, set the clarifier offset frequency (up to ±1.000 kHz) by pressing the [**◀**]/[**▶**] (move the cursor) and the [**▼**]/[**▲**] (select number) buttons. Otherwise, skip to the next step. 
- Press the [**MW**] button, then enter seven digits (from 10 MHz digit to 10 Hz digit) of the desired transmit frequency by a same procedures as entering the receiving frequency (only if you wish to store independent transmit and receive frequencies on the same channel). Otherwise, skip to the next step. 
- If you wish to append an Alpha/numeric “Tag” to this channel, press the [**MW**] button, then enter the desired name “Tag” (up 14 digits) by pressing the [**◀**]/[**▶**] (move the cursor) and the [**▼**]/[**▲**] (select character/number) buttons. Otherwise, skip to the next step. 
- Press the [**MW**] button, then press the [**▼**]/[**▲**] button to select the desired TX output power. Available selections are “HIGH”, “MID”, and “LOW”.

MEMORY CHANNEL STORAGE

- ❑ Press the [MW] button, then press the [▼]/[▲] button to select the desired ATT or RF AMP feature. Available selections are “THRU”, “ATT”, and “AMP”.



- ❑ If you wish to append this channel to the “Scan” list, press the [MW] button, and then press the [▼]/[▲] button to select “SCAN ADD” selection. Otherwise, select “SCAN SKIP” selection.



- ❑ If you wish to append a Encryption feature to this channel (requires the optional unit), press the [MW] button, then press the [▼]/[▲] button to select the desired Encryption code (“01” ~ “16”). Otherwise, skip to the next step.

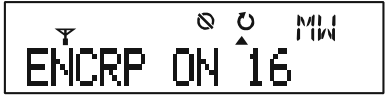

- ❑ If you wish to control the accessory port of the optional CT-139 Accessory Cable on this channel, press the [MW] button, then press the [▼]/[▲] button to select the desired logic (“HIGH” or “LOW”). Otherwise, skip to the next step.



- ❑ Press the [MW] button to store the frequency and other data into the selected memory channel.

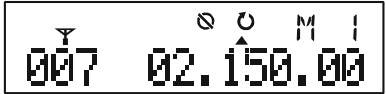

PROGRAMMABLE FUNCTION BUTTON

The **VX-1400** includes seven Programmable Function ([**S1**], [**S2**] & [**P0**] ~ [**P4**]) buttons. The Programmable Function button functions can be customized via programming by your VERTEX STANDARD dealer, to meet your communications/network requirements. Some features may require the purchase and installation of optional internal accessories. The possible Programmable Function button programming features are illustrated below, and these functions are explained follow.

For further details, contact your VERTEX STANDARD dealer. For future reference, check the box next to the function that has been assigned to each Programmable Function button on your particular radio, and keep it handy.

PROGRAMMABLE FUNCTION BUTTON

FUNCTION	PROGRAMMABLE FUNCTION BUTTON						
	S1	S2	P1	P2	P0	P3	P4
UP							
DOWN							
LEFT							
RIGHT							
1 MHz UP							
1 MHz DOWN							
A. NOTCH							
ALE							
ATT/P.AMP							
CALL							
CALL1							
CALL2							
CALL3							
CALL4							
CALL5							
CH1							
CH2							
CH3							
CH4							
CH5							
CLAR							
DIM							
DNR							
DW							
EMERGENCY							
ENCRP							
ENT							
ESC							
FILTER							
LOCK							
MODE							
MW							
N/A							
NB							
P.BACK							
PRI							
RCV MSG							
RF PWR							
SCAN							
SCAN SET							
SELCALL							
SQL							
STEP							
TAG							
TELCALL							
TUNE							
TUNE ALL							
VOICE ENHANCER							
VOX							
AUX MOMENTALLY							
AUX TOGGLE							
ALARM							
2182	—	—	—	—	—	—	—

PROGRAMMABLE FUNCTION BUTTON

UP

Press the assigned programmable button to increase the operating frequency (while in the VFO mode) or memory channel (while in the Memory mode and ITU mode). This function is same as the [▲] button.

DOWN

Press the assigned programmable button to decrease the operating frequency (while in the VFO mode) or memory channel (while in the Memory mode and ITU mode). This function is same as the [▼] button.

LEFT

Press the assigned programmable button to select the frequency control method among “VFO mode”, “Memory mode”, and “ITU mode”. This function is same as the [◀] button.

RIGHT

Press the assigned programmable button to select the frequency control method among “VFO mode”, “ITU mode”, and “Memory mode”. This function is same as the [▶] button.

1 MHz UP

Press the assigned programmable button to tune the VFO frequency upward in 1 MHz steps while operating in the VFO mode.

1 MHz DOWN

Press the assigned programmable button to tune the VFO frequency downward in 1 MHz steps while operating in the VFO mode.

A.NOTCH

Press the assigned programmable button to toggle the Auto Notch filter “on” and “off”. The Auto Notch filter reduces the interfering beat notes inside the receiving signal.

ALE

Press the assigned programmable button to toggle the ALE (Automatic Link Establishment) feature “on” and “off.”

ATT/P.AMP

Press the assigned programmable button to select the ATT or RF AMP feature. Press this button repeatedly to toggle among the available feature: “ATT ON (PRE AMP OFF)” → “PRE AMP ON (ATT OFF)” → “ATT & AMP OFF” → “ATT ON (PRE AMP OFF)” …….

CALL

Press the assigned programmable button to transmit a Selcall (or ALE) while operating in the Selcall (or ALE) mode.

PROGRAMMABLE FUNCTION BUTTON

CALL1 ~ CALL5

Press the assigned programmable button to instantly send the Selcall to the dealer pre-programmed station.

CH1 ~ CH5

Press the assigned programmable button to recall the dealer pre-programmed channel directly while operating in the Memory Channel mode.

CLAR

Press the assigned programmable button to toggle the Clarifier function “on” and “off”. The Clarifier function allows the user or dispatcher to tune the receiver frequency without changing the transmit frequency.

DIM

Press the assigned programmable button to toggle the LCD brightness level “HIGH” and “LOW”.

DNR

Press the assigned programmable button to toggle the Digital Noise Reduction system “on” and “off”. The Digital Noise Reduction system reduces the level of random noise found on the operating band.

DW

Press the assigned programmable button to toggle the Dual Watch feature “on” and “off”. The Dual Watch feature allows the user or dispatcher to operate on one channel while periodically making a brief check of Memory Channel “1-001” (Memory Bank #1, Channel #1).

EMERGENCY

Press (or press and hold in: determined from the dealer programming) the assigned programmable button to activate the Emergency mode in accordance with the dealer programming.

Important Note: The Emergency feature does not work with this combination with the optional **MD-12A8J** Desktop Microphone.

ENCRP

Press the assigned programmable button to toggle the Encryption feature “on” and “off”. When the Encryption feature is activated, the “” icon will appear in the LCD.

ENT

Press the assigned programmable button to send an “Entry” command.

ESC

Press the assigned programmable button to send an “Escape (Cancel)” command.

PROGRAMMABLE FUNCTION BUTTON

FILTER

Press the assigned programmable button to enable selecting the receiver bandwidth. To select the receiver bandwidth, press this button briefly, then press the [▼]/[▲] button to select the desired receiver bandwidth (“Wide”, “Normal”, “Narrow”, and “Super Narrow: except the A3E mode”); finally press this button again.

LOCK

Press the assigned programmable button to toggle the Key Lockout feature “on” and “off”. The “” icon will appear in the LCD when the Key Lockout feature is activated. The lockout combinations are dependent upon the dealer programming.

MODE

Press the assigned programmable button to select the operating mode. Press this button repeatedly to toggle among the available operating mode: “J3EU” → “J3EL” → “J2BU” → “A1A” → “A3E” → “J3EU” …….

MW

Press the assigned programmable button to activate the “Memory Write” mode.

N/A

This is the No Action command.

NB

Press the assigned programmable button to toggle the Noise Blanker “on” and “off”. The Noise Blanker reduces the noise caused by automotive ignition system.

P.BACK

Press the assigned programmable button to play back the receiver audio for the most-recent 20 seconds of reception before you press this button.

PRI

Press the assigned programmable button to activate the Priority Scan.

RCV MSG

Press the assigned programmable button to recall the last-received Selcall or ALE Message.

RF PWR SEL

Press the assigned programmable button to select the transmit power output level (“Low”, “Medium”, and “High”). The “**L**” icon will appear at the left of the display while operating on the “Low Power” setting, and the “**M**” icon will appear at the left of the display while operating on “Medium Power” setting.

PROGRAMMABLE FUNCTION BUTTON

SCAN

Press the assigned programmable button to activate the upward scan. When the scanner is activated, press the [▼]/[▲] button to change the direction of the scanner to downward or upward, respectively. In the memory mode, the **VX-1400** scan only the memory channel which the “U” icon appears.

SCAN SET

Press the assigned programmable button to toggle the current memory channel shall be “addition” or “deletion” from scan list. When the current memory channel is in the scan list, the “U” icon will appear in the LCD.

SELCALL

Press the assigned programmable button to toggle the SELCALL feature “on” and “off.”

SQL

Press the assigned programmable button to enable silencing the receiver noise when no signals are being received (Adjusting the Squelch threshold level). To silencing the receiver noise, press this button briefly, then press the [▼]/[▲] button to the point where the background noise is just silenced; finally press this button again.

STEP

Press the assigned programmable button to enable changing the frequency digit of the synthesizer step. Press this button briefly to enable changing the frequency digit of the synthesizer step, select the frequency digit which enable selecting the operating frequency by the [◀]/[▶] button, then press the [▼]/[▲] button to the desired value; finally press this button again to terminate the frequency entry.

TAG

Press the assigned programmable button to select the memory channel display format (“Memory Channel with Frequency”, “Alpha/numeric Tag”, and “Memory Channel with Frequency and Alpha/numeric Tag alternately”).

TELCALL

Press the assigned programmable button to transmit a Telcall while operating in the Selcall.

TUNE

Press the assigned programmable button to activate the antenna tuning process.

TUNE ALL

Press the assigned programmable button to activate the antenna tuning process to the all memory channels in the current memory bank.

VOICE ENHANCER

Press the assigned programmable button to toggle the Voice Enhancer feature “on” and “off”.

PROGRAMMABLE FUNCTION BUTTON

VOX

Press the assigned programmable button to toggle the VOX feature “on” and “off”.

The VOX feature provides automatic transmit/receive switching based on voice input to the microphone. With the VOX system enabled, user or dispatcher do not need to press the PTT switch in order to transmit.

The “**VOX**” icon will appear on the display when the VOX feature is activated.

Important Note: The VOX feature does not work with this combination when using the optional **MD-12A&J** Desktop Microphone.

AUX MOMENTALLY

Press the assigned programmable button to turn the accessory port of the optional **CT-139** Accessory Cable “high”.

AUX TOGGLE

Press the assigned programmable button to toggle the accessory port of the optional **CT-139** Accessory Cable “on” and “off”.

ALARM

Press the assigned programmable button to activate the alarm generator. Pressing both this button and the **[2182]** button transmits the International Marine Distress Signal.

Important Note: This function is assigned to only **[S1]** button.

2182

Press the assigned programmable button to instantly set the transceiver to 2182 kHz in the H3E mode. Pressing both this button and the **[ALARM]** button transmits the International Marine Distress Signal.

Important Note: This function is assigned to only **[S2]** button.

INSTALLATION OF THE OPTION

ALE-2 AUTOMATIC LINK ESTABLISHMENT UNIT

- ❑ Make sure that the transceiver is off. Remove the DC Power Cable, Microphone, and Antenna from the transceiver.
- ❑ Referring to illustration at the right, remove the eight screws affixing the Top Cover, and remove the Top Cover.
- ❑ Referring to illustration below, mount the ALE-2 Unit to the transceiver by the supplied two screws, then connect the supplied connection cable between the ALE-2 Unit and the J4006 on the Main Unit of the transceiver.
- ❑ Replace the Top Cover with its eight screws while being careful that any wires are not pinched.
- ❑ Reconnect the DC Power Cable, Microphone, and Antenna to the transceiver. This completes installation of the ALE-2 Automatic Link Establishment Unit.

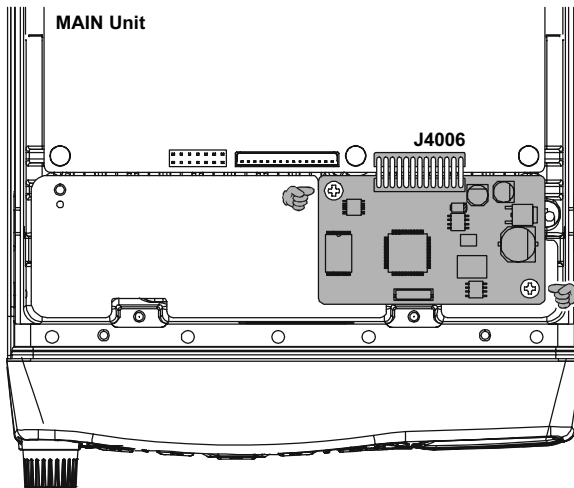
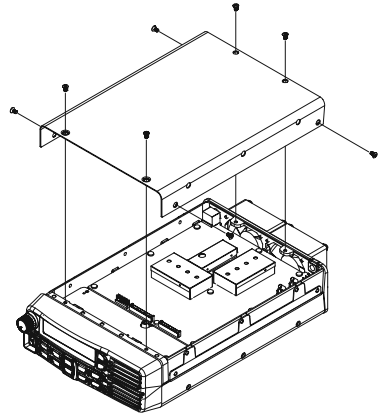

INSTALLATION OF THE OPTION

CT-139 ACCESSORY CABLE

The CT-139 allows connecting the external accessories such as CW Keyer, Data Transmission/Reception Modem, and External Channel Control Input etc.

- ❑ Ensure that the transceiver is off. Remove the DC Power Cable, Microphone, and Antenna from the transceiver.
- ❑ Referring to illustration at the right, remove the eight screws affixing the Top Cover, and remove the Top Cover and then remove the Rubber Gasket from the transceiver.
- ❑ Referring to illustration below, mount the CT-139 Accessory Cable to the transceiver, then connect the 12-pin connector of the CT-139 to the J4013 on the Main Unit and connect the 13-pin connector of the CT-139 to the J4012 on the Main Unit of the transceiver. Connect the Ground Cable of the CT-139 to the transceiver's chassis with the screw fixing the Main Unit while being careful not to break any electrical parts on the Main Unit.
- ❑ Fix the wire of the CT-139 so that the wire is not pinched between a part on the Main unit and the top case.
- ❑ Replace the Top Cover with its eight screws while being careful so that any wires are not pinched.
- ❑ Reconnect the DC Power Cable, Microphone, and Antenna to the transceiver. This completes installation of the CT-139 Accessory Cable.

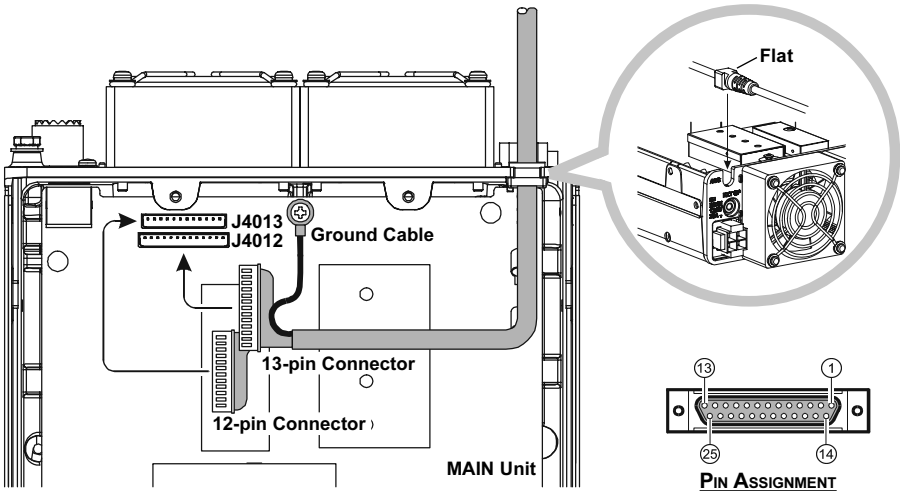
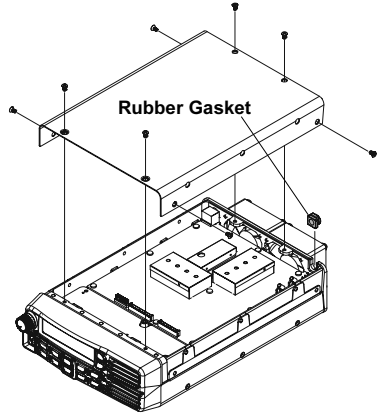

INSTALLATION OF THE OPTION

CT-139 ACCESSORY CABLE

PIN ASSIGNMENT

PIN #	FUNCTION	DESCRIPTION
1	AUX I/O-1	This pin feature can be programmed via the CE111 programmer. The accessible voltage is CMOS Logic Level (H = 5 V).
2	EXT ALC	This pin accepts ALC (Automatic Level Control) voltage from a linear amplifier, to prevent over-excitation by the transceiver.
3	TX GND	This pin is closed to ground while the transceiver's transmitter is engaged. The capable of switching voltage is 60 V DC, 1 A. Do not connect any equipment when the FC-30/-40 antenna tuner is connected to the transceiver.
4	TX INH	When this pin accepts 5 V, the transceiver stops the TX output while maintaining the transmission status. Do not connect any equipment when the FC-30/-40 antenna tuner is connected to the transceiver.
5	KEY	This pin accepts a CW key or keyer. Key up voltage is +5 V, and key down current is 1 mA.
6	FSK	This pin accepts a TX/RX switching line of the FSK/RTTY modem. Key up voltage is +5 V, and key down current is 1 mA.
7	GND	This pin is connected to the transceiver's chassis.
8	Reserved	This pin is for future expansion of the transceiver's capability. Do not connect any equipment to this pin.
9	Reserved	This pin is for future expansion of the transceiver's capability. Do not connect any equipment to this pin.
10	Reserved	This pin is for future expansion of the transceiver's capability. Do not connect any equipment to this pin.
11	DATA PTT	This pin accepts a keying line of the FSK/RTTY modem. Key up voltage is +5 V, and key down current is 1 mA.
12	TX REQ	When this pin is connected to ground, the transceiver into the transmit mode, and sends out a steady CW carrier, for linear amplifier adjustment.
13	DATA IN	This pin accepts the AFSK input from the AFSK modem. The optimum input level is 60 mVp-p @1 kΩ.
14	13.8V DC	This pin provides 13.8V DC at up to 100 mA, to power an external device.
15	IGNITION	The transceiver may be automatically be switched to on when the vehicle's ignition key turned on. Maximum voltage is 13.8 V.
16	N.C.	No Connection
17	DATA OUT	This pin outputs the receiver audio (100 mVp-p @1 kΩ) for use with the AFSK modem.
18	N.C.	No Connection
19	AUX I/O-2	This pin feature can be programmed via the CE111 programmer. The accessible voltage is CMOS Logic Level (H = 5 V).
20	AUX I/O-3	This pin feature can be programmed via the CE111 programmer. The accessible voltage is CMOS Logic Level (H = 5 V).
21	CAT/GPS	This pin accepts the NMEA data from the GPS receiver (or CAT data for programming the transceiver). The accessible voltage is RS-232 Level.
22	CAT/GPS	This pin outputs the NMEA data for the GPS receiver (or CAT data for programming the transceiver). The accessible voltage is RS-232 Level.
23	SQL OUT	This pin is closed to ground while the transceiver's squelch is closed.
24	AUX I/O-4	This pin feature can be programmed via the CE111 programmer. The accessible voltage is CMOS Logic Level (H = 5 V).
25	GND	This pin is connected to the transceiver's chassis.

ACCESSORIES & OPTIONS

SUPPLIED ACCESSORIES

- DC Power Cord T9025225
- Spare Fuse (25 A Blade Type) Q0000074
- Operation Manual
- Warranty Card

AVAILABLE OPTIONS

FP-1030A	AC Power Supply
MD-12A8J	Desktop Microphone* ¹
MH-31A8J	Hand Microphone (Dynamic)* ²
MH-67A8J	Hand Microphone
MH-77A8J	Hand Microphone (Water Resistant w/Keypad)
MH-77B8J	Hand Microphone (Water Resistant)
FC-30	Antenna Tuner (Coaxial Lines; 1.8 - 30 MHz)
FC-40	Antenna Tuner (Wire/Whip Antennas)
ALE-2	Automatic Link Establishment Unit
MLS-100	External Speaker
MLS-200	External Speaker
YA-30	Broadband HF Antenna (Dipole Type)
YA-31	Broadband HF Antenna (Dipole or Wire (end fed) Type)
YA-007FG	HF Multi-Band Mobile Antenna (requires FC-40; 7 - 30 MHz)
RMK-1400	Remote Mounting Kit
CT-93	Control Cable (33 ft, 10 m)
CT-81	Control Cable (20 ft, 6 m)
CT-82	Control Cable (8 ft, 2.5 m)
CT-83	Control Cable (2 ft, 0.6 m)
CT-139	Accessory Cable
MMB-92	Mobile Bracket
CE111	PC Programming Software
FIF-10A	USB Programming Interface (requires CT-104A)
CT-104A	PC Programming Cable
VPL-1	PC Programming Cable

*1: The VOX and Emergency feature of the transceiver does not work with **MD-12A8J**.

*2: The [UP]/[DWN] key does not work in this transceiver.



Copyright 2010
VERTEX STANDARD CO., LTD.
All rights reserved.

No portion of this manual
may be reproduced
without the permission of
VERTEX STANDARD CO., LTD.

Printed in Japan

10020-CE

