

YAESU
The radio

C4FM/FM 144/430MHz
DUAL BAND DIGITAL TRANSCEIVER

FT5DR
FT5DE

Operating Manual



Contents

Introduction	2	Repeater Operation	29
Quick Guide	3	Communicating Via the Repeater	29
Controls & Connections	4	Using the Memory	30
Transceiver	4	Registering to Memory Channels.....	30
Operation Keys	5	Recalling a Memory Channel	31
Changing the Transceiver settings.....	5	Recall only memories in the same fre-	
Touch Screen Display.....	6	quency band (Band) using the memory	
Safety Precautions (Be Sure to Read) ...	12	auto grouping (MAG) function	31
Supplied Accessories and Options	15	Clearing Memories	32
Supplied Accessories	15	Restored erased memory.....	32
Available Options.....	15	Using Memory Tag	32
Preparation	16	Recalling the Home Channels.....	33
Installing the Antenna.....	16	Changing the Home Channel	
Installing the Battery Pack.....	16	Frequency.....	33
Attaching the Quick Release Holster	16	Memory Channel List	33
Attaching the Belt Clip	16	Split Memory.....	33
Charging the Battery Pack	17	Using Memory Bank	33
Charging the Battery Pack		Memory Only Mode	33
using the Battery Charger	17	PMG (Primary Memory Group	
Charging the Battery Pack		Activity Monitor)	34
using the Rapid Charger	17	Register the frequency with PMG	34
External Power Supply	18	Touch the bar graph	
Connecting an External		to switch the frequency.....	35
Power Supply for Use in a Vehicle ...	18	Unregister the channel (frequency)	
Connecting to an External		registered in PMG...	35
Power Supply Using a Power Cable ...	18	Disable the PMG function	35
Using a microSD Memory Card	18	CAM (Channel Activity Monitor)	
Usable microSD Memory Cards	18	function	36
Mounting and Dismounting		Register memory channel	
microSD Memory Card.....	18	to CAM group.....	36
Formatting a microSD Memory Card	19	Using the CAM function.....	38
Operation	20	Touch the bar graph	
Turning the Transceiver ON	20	to switch the frequency.....	38
Adjusting the Volume Level	20	Change the displayed CAM group	38
Adjusting the squelch setting	21	Delete a registered memory channel	
Toggling the Operating Band.....	21	from CAM group ...	39
Selecting a Frequency Band	22	Delete all the contents	
Tuning to a Frequency	22	in the CAM group at once.....	40
Changing the Frequency Step.....	23	Changing the name (tag)	
Selecting the Communication Mode	23	of CAM group.....	40
Transmission.....	24	Disable the CAM function.....	41
Changing the Transmit Power Level	25	Band Scope.....	42
Locking Keys and DIAL knob	25	Scanning Function	43
Using the convenient		VFO Scan	43
Digital C4FM feature	26	Memory Channel Scanning.....	43
About the Digital Group ID (DG-ID) feature ...	26	Setting the Receive Operation When	
Communicating with the DG-ID feature ...	26	Scanning Stops	44
		Weather Alert Scan	44

Skip Memory Channels, and Specified Memory Channels	45
Programmable Memory scan (PMS).....	45
Dual Receive (D.RCV) feature	45
Convenient Functions	46
Bluetooth® Operation	46
VOX Operation	50
Convenient Preset Receiver Memory Channels.....	52
Using the Voice Recording	56
Taking Pictures (Snapshot Function).....	58
GPS Function	59
WIRES-X function	60
APRS (Automatic Packet Reporting System) function ..	60
Tone squelch feature	61
Digital Code squelch (DCS) feature	61
New PAGER (EPCS) feature.....	61
Digital Personal ID (DP-ID) feature	61
Using Setup Menu	62
Setup Menu Operation	62
Tables of Setup Menu Operations	63
Restoring to Defaults (Reset).....	69
All Reset.....	69
Setup Menu Reset.....	69
Text input screen.....	70
Specifications	72
YAESU LIMITED WARRANTY	74

Introduction

Features of the Yaesu FT5DR/DE Transceiver.

- Digital communication using Yaesu (C4FM (Quaternary FSK) system).
- Equipped with AMS (Automatic Mode Select) Function.
The AMS (Automatic Mode Select) feature automatically selects the analog FM and C4FM digital modes, according to the signal of the other station.
- The DG-ID (Digital Group ID) feature, and the Group Monitor (GM) feature enable automatically locating, and communicating with other stations within contact range, that have the matching DG-ID number, (Group ID number from 00 to 99).
- Full color 320x240 dot LCD, high resolution TFT touch panel display.
The communication status and settings of the FT5DR/DE are displayed in a straightforward manner, achieving excellent operability.
- Equipped with Bluetooth® function as standard.
Supports hands-free communication using the optional Bluetooth® headset SSM-BT20 or a commercially available product.
- WIRES-X connection support.
- Supports WIRES-X portable digital node function.
- Equipped with GM function.
- Digital Personal ID (DP-ID) feature.
- Simultaneous reception of two separate frequencies, on different bands, or within the same band (V+V/U+U).
- Wide-band reception (520kHz to 999.995MHz) (USA Cellular Blocked)).
- Waterproof design equivalent to IPX7, which protects the transceiver from rain and splashes.
- Built-in GPS unit permitting display of the current location and heading information.
- Large-capacity 1256 memory channels.
- The Memory Auto Grouping (MAG) function allows automatic grouping and recalling only memory channels in the same frequency band.
- Register frequently used frequencies into the PMG (Primary Memory Group Activity Monitor), and then pressing the **[PMG●]** key will display the registered frequency status (signal strength) in a bar graph (up to 5 channels). You can instantly move to that channel by simply touching the bar graph (TOUCH & GO Operation).
- Display memory tags comprised of up to 16 alpha/numeric characters.
- Convenient reception of preset receiver memory channels.
- A wide variety of scan features.
- Ready for APRS® communication with world standard 1200 / 9600bps AX25 modem (B-band only).
- High-resolution band scope that displays 79 channels.
- Smart Navigation function.
- Snapshot function (optional camera/microphone MH-85A11U is required).
- A variety of individual Selective Calling functions (Tone Squelch (CTCSS) and DCS etc.).
- Compatible with microSD memory cards.

Thank you for purchasing the FT5DR/DE Transceiver. We urge you to read this manual in its entirety, and also the Advance Manual (available for download on the Yaesu website), to gain a full understanding of the amazing capability of the exciting new FT5DR/DE Transceiver.

WIRES-X, GM function and APRS instruction manuals are not included in the product package. They are available and may be downloaded from the Yaesu.com website.

① Turning the Power ON

Install the charged battery pack and then press and hold the Power switch.

② Inputting the Call sign

When turning the power ON for the first time after purchasing, input the call sign of your own station.

Input call sign may be changed from Setup Menu [CALLSIGN] (page 68).

1. When turning the power ON for the first time after purchasing, the call sign input screen will be displayed.

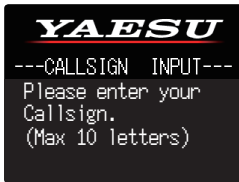

2. Press the [F MENU] key.



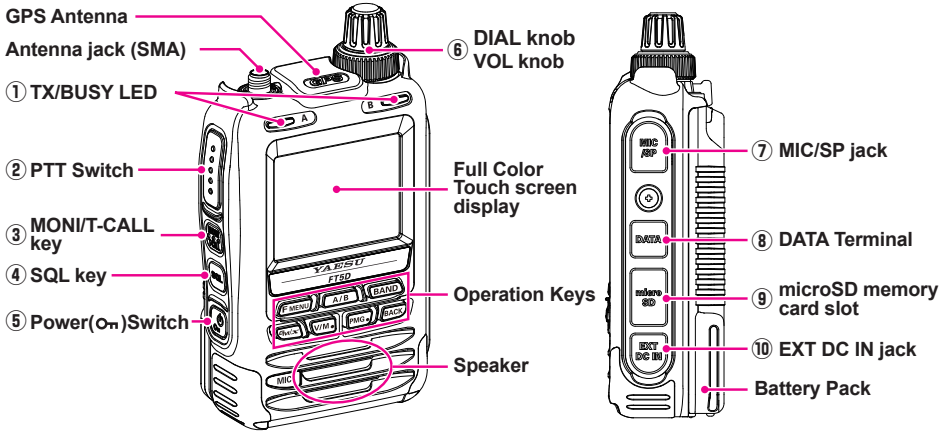

Controls & Connections

Transceiver



- ① **TX/BUSY LED**
Lights blue (C4FM digital) or green (Analog FM) during receive and lights red during transmit. Blinks while receiving a signal that does not match the DG-ID or similar tones.
- ② **PTT Switch**
Press and hold the **PTT** switch to transmit, and release it to receive.
- ③ **MONI/T-CALL key**
Press to return to the previous screen.
USA/Asian version
Press the **MONI/T-CALL** key to open the squelch.
European version
Press the **MONI/T-CALL** key to activate the T-CALL (1750 Hz).
- ④ **SQL key**
Press the **SQL** switch, then rotate the **VOL** knob to adjust the squelch level.
- ⑤ **Power (Lock) Switch**
 - When the power is OFF, press and hold this switch to turn the Power ON.
 - When the power is ON, press and hold the switch again to turn the Power OFF.
 - When the power is ON, press this button briefly to engage, or release the key lock.
- ⑥ **DIAL knob**
Rotate the **DIAL** Knob to change the frequency or select a memory channel.
VOL knob
Rotate the **VOL** Knob to adjust the audio volume level.

- ⑦ **MIC/SP jack***
Connect the optional speaker microphone or earpiece microphone to this jack. When an external microphone or cable is connected, the dust and splash protection does not function.
 Do not connect any microphone which is not specified by Yaesu.
- ⑧ **DATA Terminal***
 - Connect the optional camera-equipped microphone (MH-85A11U) to this terminal.
 - To use the clone function, connect to another FT5DR/DE with an optional clone cable (CT-168).
 - When updating the firmware, connect to a PC using a USB cable.
* For instructions to update the firmware, access the Yaesu Website.
 - An external GPS may be connected to this terminal.
- ⑨ **microSD memory card slot***
- ⑩ **EXT DC IN jack***
 - When charging the battery pack, connect the battery charger (SAD-25) to this jack.
 - Connect an external power supply adapter with a cigarette lighter plug (SDD-13) or an external power cable (E-DC-6) to this jack.
 Do not connect any battery charger which is not specified by Yaesu.

* When the included antenna and battery pack are installed and the MIC/SP jack, DATA terminal, microSD card slot and EXT DC IN jack are securely covered with rubber caps, the FT5DR/DE meets the waterproofing performance conforming to IPX7.

Operation Keys

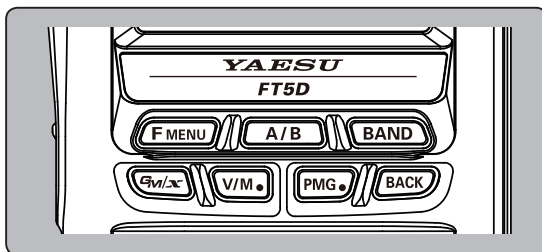

	Press	Press and Hold
F MENU key	Pressing each time switches between function screen and normal screen.	Press and hold for over one second to enter Setup Menu.
A/B key	Pressing each time switches between A-band and B-band.	Press and hold for over one second to switch between the Dual Band Receive mode and the Mono Band Receive mode.
BAND key	Pressing each time increases the frequency band.	-
GM/X key	Press to turn the GM function ON/OFF.	In normal mode, press and hold for over one second to start WIRES-X. When WIRES-X is activated, press and hold for over one second to return to the normal mode.
V/M key	Pressing each time switches between VFO mode and memory mode.	Press and hold for over one second to write to memory.
PMG key	Pressing each time switches between PMG (Primary Memory Group Activity Monitor) mode and memory or VFO mode.	Press and hold for over one second to writing to PMG memory.
BACK key	Return to the previous screen.	-

Changing the Transceiver settings

1. Press and hold the [**F MENU**] key.
The SETUP MENU screen will be displayed.
2. Touch the desired item in Setup Menu.
The Sub-menu screen will be displayed.
May also be operated by rotating the **DIAL** knob to select the desired item in Setup Menu, and then press the [**F MENU**] key.
3. Press the **PTT** switch to save the settings and return to normal operation.
Press the [**BACK**] key to save the settings and return to the previous screen.

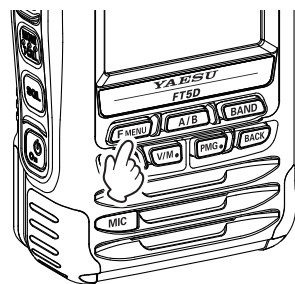

Touch Screen Display

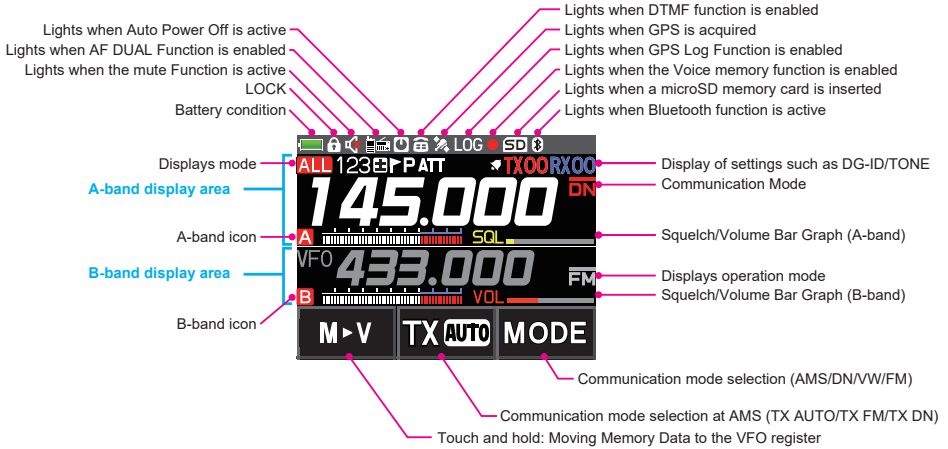

Status Bar



The battery condition is displayed in 8 steps.

- : Full battery power
- : Battery is depleted. Charge battery.
- : (When blinking) Charge battery immediately.
- : Charging (displayed when the power is ON).



Appears when the lock function is enabled.



Appears when the Mute function for B-band is enabled.



Appears when the AF DUAL function is enabled.



Appears when the APO (Automatic Power-Off) function is enabled.



Appears when the DTMF Autodialer function is activated.



Appears when the Built-in GPS function is activated.

Appears: Satellites are acquired.

Blinks: Satellites cannot be acquired.



Appears when the Voice recording function is activated (About 3 seconds after the squelch closes, the recording pauses and a "||" appears.).



Appears when the GPS Log function is enabled.



Appears when a microSD card is inserted.



Appears when the Bluetooth[®] function is activated.

Appears: Bluetooth[®] device is connected.

Blinks: Bluetooth[®] device not connected.

A-band / B-band display area

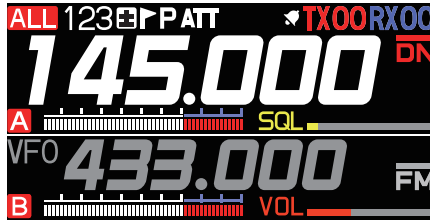

A-band / B-band display modes

VFO : VFO mode

PMG : PMG mode (Recalls only the frequencies registered in PMG)

ALL 123 : Memory mode (The numeric is the memory channel number)

Press the BAND key while in memory mode, the MAG function can automatically recall memory channels in groups for each of the following bands: (For details, refer to "Using the Memory" on page 30.)

ALL / AIR / VHF / UHF / AM / FM / SW / OTHER

HOM : Home Channel

VDR : VFO Dual Receive (VFO ↔ Priority Memory Channel)

MDR : Memory Channel Dual Receive (Memory Channel ↔ Priority Memory Channel)

HDR : HOME Channel Dual Receive (HOME Channel ↔ Priority Memory Channel)

[] : Repeater minus (-) shift

[+] : Repeater plus (+) shift

[] : Split operation



[] : Specified Memory Channel (Specify that only designated memory channels are scanned during memory scanning.)



[X] : Skip Memory Channel (Permits designating unwanted channels to be skipped during scanning.)



[P] : Priority Memory Channel (The transceiver checks for signals on the frequency registered to the selected Priority Memory Channel, once every 5 seconds.)



ATT : ATT (attenuator) function (When the desired signal is extremely strong, activate the attenuator to reduce the incoming signal from the antenna.)



[] : Bell function is activated.



TX00RX00

TX/RX DG-ID is displayed

TXnn (The transmit DG-ID number), RXnn (The receive DG-ID number)

Squelch type is displayed (For additional details, refer to the Advanced Manual.)

TN : Tone Encoder (tone frequency is displayed)

TSQ : Tone Squelch (tone frequency is displayed)

DCS : DCS (Digital Code Squelch) (DCS code is displayed)

RTN : Reverse Tone (tone frequency is displayed)

PR : Signal Squelch

PAG : Pager (EPCS)

TN

The following can be set when the squelch expansion (see page 64) is on.

DC : Send the DCS code only during transmission.

T-D : Send the CTCSS tone signal during transmit, and wait for the DCS code in receive mode. (tone frequency is displayed)

D-T : Send the DCS code during transmit, and wait for the CTCSS tone signal in receive mode. (tone frequency is displayed)

Displays the operating mode (Digital mode is indicated by a red icon)

FM : FM (Analog) mode

DN : Normal digital mode (digital mode using C4FM modulation)

VW : Wide digital mode (digital mode using C4FM modulation)

DW : Data FR mode (data communication mode using C4FM modulation)



FM : AMS (Automatic Mode Select) FM (Analog) mode

DN : AMS (Automatic Mode Select) DN mode

VW : AMS (Automatic Mode Select) VW mode

DW : AMS (Automatic Mode Select) DW mode

When AMS (Automatic Mode Select) function is activated, indicator is shown with a bar appearing above the mode. The transceiver automatically switches to the DW mode during image transmission.



A : A-band icon

B : B-band icon



: S meter (Displays received signal strength in 10 levels)



: PO meter (Displays transmit output in 4 levels when transmitting)



: Volume level



: SQL level

Touch keys display area



Touch and hold: Moving Memory Data to the VFO register.

Each touch steps the transmit communication mode as follows:

→ TX (AUTO) → TX (FM) → TX (DN) → TX (AUTO) → ...



TX (AUTO): Automatically selects the transmit mode to correspond to the received signal.

TX (FM): Always transmits in the analog FM mode.

TX (DN): Always transmits in the digital (DN) mode.

Each touch steps the communication mode as follows:

→ (**FM** / **DN** / **VW**)^{*1} → **DN** → **VW**^{*2} → **FM** → (**FM** / **DN** / **VW**)^{*1} → ...

The current communication mode is displayed on the upper right of the frequency.

FM / **DN** / **VW**^{*1}:

AMS function operation (A bar is displayed at the top of the communication mode icon, and the AMS function automatically displays the selected communication mode.)



DN : V/D Mode (Voice/Data simultaneous transmission mode)

VW^{*2}: Wide digital mode (high-quality digital communication)

FM : FM (Analog) mode

*1 The AMS (Automatic Mode Select) function displays one of the **FM** / **DN** / **VW** icons for the automatically selected communication mode.

*2 When the Setup Menu item [TX/RX] → [2 DIGITAL] → [4 DIGITAL VW] is set to "ON" (factory default is "OFF"), the Voice FR (VW) may be selected.

● Dual Band Screen

A-band and B-band are displayed in a top-down fashion.
Both bands are received simultaneously.

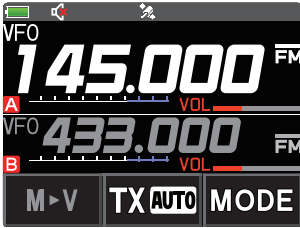

- Touch and hold the frequency of the operation band (white display) to display the numeric keypad screen for frequency input.
- Touch the sub-band (gray display) frequency to change the operation band.
- When both the operation band and the sub-band are receiving signals at the same time, the audio on the sub-band receiver is automatically muted. Setup Menu: [TX/RX] → [3 AUDIO] → [2 MUTE]: Allows setting the muting level.



Press and hold the [A/B] key.

● Mono Band Screen

A-band or B-band is displayed.
Receives only the displayed band.

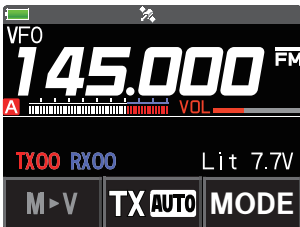

- Touch and hold the frequency to display the numeric keypad screen for frequency input.
- The memory tag and battery voltage etc. are displayed on the lower segment.

● Function Menu Screen (Press the [F MENU] key)

- Press the [F MENU] key to displays the function menu screen.
- Press the [BACK] key to return to the previous screen.
- There are two function menus. Touch [FWD →] or [BACK ←] at the bottom right of the display to switch the screens.
- Depending on the communication mode and settings, some functions may not operate when the Menu item is touched.

Function Menu Screen 1

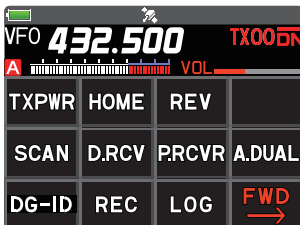

Function Menu Screen 2



● PMG (Primary Memory Group Activity Monitor) Screen (Press the [PMG●] key)

Up to 5 frequencies registered in PMG are displayed, and the signal strength received by each channel is displayed as a bar graph.



- Touch the bar graph to instantly switch the receiver to that frequency.
- Information on the selected channel is displayed at the top of the screen, and you can transmit immediately by pressing PTT.

● CAM (Channel Activity Monitor) Screen (Press the [F MENU] key → Touch [CAM])

Frequencies that are often used with friends can be registered to the CAM group memory channels, and then displayed on the CAM screen. The signal status and strength of each channel in the selected group are shown in a bar graph.

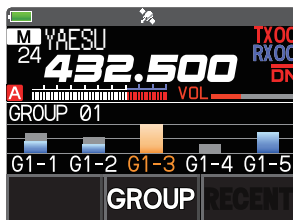

- Touch the bar graph to instantly switch the receiver to that frequency.
- CAM Group: Up to 10 groups, with up to 5 memory channels each, can be registered in each group.

● Band Scope Screen (Press the [F MENU] key → Touch [SCOPE])

In VFO mode, the Band Scope searches the channels above and below the center receive frequency at high speed. The signal strengths are displayed on a graph, so the presence or absence of a signal on any channel is easily noted.

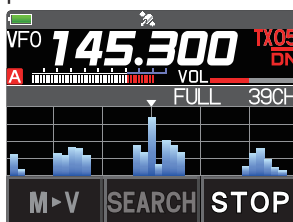

- The frequency may be changed by turning the DIAL knob.
- Touch [SEARCH] or [STOP] to begin or stop the search.
- The number of channels to search in Band Scope may be set to 19, 39 or 79. (See "Change the number of channels displayed" page 42).
- To end the Band Scope function, press the [BACK] key.

● GM (Group Monitor) Screen (Press the [GM/X] key)

Automatically listens for stations operating with GM function on the same frequency, that are within the communication range, and displays the call sign, direction, distance, within / outside. For details, refer to the separate GM Instruction Manual which is available on the Yaesu website.

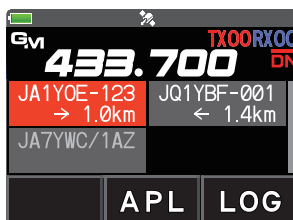

- The call signs of the stations that can communicate is displayed in white characters.
- The call signs of stations outside the sphere of communications are displayed in gray characters.
- Touch [APL], to display the positions of multiple member stations on the compass screen, centered on your own station.
- Touch [LOG] to view previously sent or received messages and photos.
- To end the GM function, press the [GM] key.

● **AF DUAL Screen (Press the [F MENU] key → Touch [A.DUAL])**

While receiving and listening to a radio broadcast, the A-band and B-band may also be monitored simultaneously for activity.

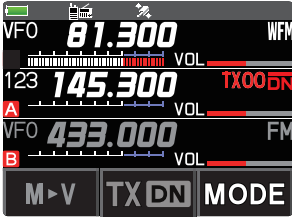

- When a signal is received on A-band or B-band, the broadcast audio is muted and the A or B band audio is heard.
- To end the AF DUAL function, press the [BACK] key.

● **BACKTRACK Screen (Press the [F MENU] key → Touch [DISP])**

The backtrack screen, or the GPS information screen, whichever was displayed last, will be displayed.

- Real-time navigation function

Touch [] at the top left of the screen to display the position and direction of the partner station in real time during communication in C4FM digital V/D mode. (The signal of the partner station must contain location information.)

- BACKTRACK function

May register the departure point etc. up to 3 places (“★”, “L1”, “L2”) in advance and display the distance from the current location to the registered point in real time.

● **GPS Information Screen (Press the [F MENU] key → Touch [DISP])**

The backtrack screen, or the GPS information screen, whichever was displayed last, will be displayed. The GPS satellites status and numbers are shown.

The following information is displayed.

- Direction and elevation of satellites, and their signal strengths
- Current time and date
- Current latitude and longitude
- Moving Speed
- Altitude of current location

Backtrack Screen

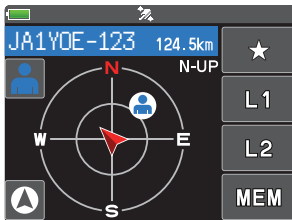

GPS Information Screen

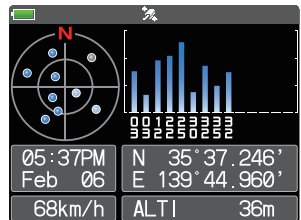

Touch the screen (other than the Touch keys).

● **SETUP MENU Screen (Press and hold the [F MENU] key)**

Setup Menu allows selecting various functions from the displayed list and setting the parameters of each function according individual preferences.



- Press the PTT switch or press the [BACK] key several times to exit the Setup Menu.

Safety Precautions (Be Sure to Read)

Be sure to read these important precautions, and use this product safely.

Yaesu is not liable for any failures or problems caused by the use or misuse of this product by the purchaser or any third party. Also, Yaesu is not liable for damages caused through the use of this product by the purchaser or any third party, except in cases where ordered to pay damages under the laws.



Types and meanings of the marks



 **DANGER** This mark indicates an eminently hazardous situation, which, if not avoided, could result in death or serious injury.

 **WARNING** This mark indicates a potentially hazardous situation, which, if not avoided, could result in death or serious injury.

 **CAUTION** This mark indicates a potentially hazardous situation, which, if not avoided, may result in minor or moderate injury or only property damage.

Types and meanings of symbols

 These symbols signify prohibited actions, which must not be done to use this product safely. For example:  indicates that the product should not be disassembled.

 These symbols signify required actions, which must be done to use this product safely. For example:  indicates that the power plug should be disconnected.

DANGER

 **Do not use this product in an area where RF transmitters are prohibited, e.g., inside of a hospital, airplane, or train.**
This product can affect electronic or medical devices.

 **Do not transmit with this device while carrying or using a medical appliance such as a cardiac pacemaker. When transmitting, use an external antenna and keep as far as possible away from the external antenna.**
The radio wave emitted by the transmitter can cause the medical device to malfunction and result in injury or death.



 **Do not transmit with this device in a crowded place for the safety of persons using a medical device such as a cardiac pacemaker.**
The radio wave emitted from this product can cause the medical device to malfunction and result in injury or death.

 **Do not use this product or the battery charger anywhere inflammable gas is produced.**
A fire or explosion can occur.

 **If thunder and lightning develop nearby when an external antenna is used, immediately turn this transceiver OFF, and disconnect the external antenna from it.**
A fire, electrical shock, or damage may result.

 **Do not use this product while riding a bicycle or driving a car. Accidents can result.**
Be sure to stop the bicycle or car at a safe place before using this product.

 **Do not touch any material leaking from the LCD display or the battery pack with bare hands.**
The chemical may adhere to your skin or enter your eye, and cause chemical burns. In such a case, consult the doctor immediately.

 **Do not solder or short-circuit the terminals of the battery pack.**
A fire, leak, overheating, explosion, or ignition may result.
 **Do not carry the battery pack together with a necklace, hairpin, or small metal objects. A short circuit can result.**

WARNING

 **Do not disassemble or make any alteration to this product.**
An injury, electric shock, or failure may result.

 **Do not handle the battery pack or charger with wet hands. Do not insert or remove the power plug with wet hands.**
An injury, leak, fire, or failure may result.

 **Do not power this transceiver with a voltage other than the specified power supply voltage.**
A fire, electric shock, or damage may result.

 **Keep the terminals of the battery pack clean.**
If terminal contacts are dirty or corroded, a fire, leak, overheating, explosion, or ignition can result.

If smoke or a strange odor is emitted from the main body, battery pack, or battery charger, immediately turn the transceiver off; remove the battery pack, and remove the power plug from the outlet.



A fire, chemical leak, overheating, component damage, ignition, or failure may result. Contact the dealer from which you purchased this product or Yaesu.

Do not bend, twist, pull, heat or modify the power cord and connection cables in an unreasonable manner.



This may cut or damage the cables and result in fire, electric shock and equipment failure.

Do not pull the cable when plugging and unplugging the power cord and connection cables.



Always hold the plug or connector when unplugging; if not, a fire, electric shock and equipment failure may result.

Do not use the device when the power cord and connection cables are damaged, or when the DC power connector cannot be plugged in tightly.



Contact Yaesu or the retail store where this transceiver was purchased for assistance, as this may result in fire, electric shock and equipment failure.

Do not install the transceiver or the wire cables near the automobile air bags.



In case of an accident, the transceiver may interfere with air bag deployment and result in extreme injury. The wire cables may also cause the air bag to malfunction.

Do not make very long transmissions.



The main body of the transceiver may overheat, resulting in component failure or operator burns.

Do not place the transceiver in wet or damp areas (e.g. near a humidifier).



This may result in fire, electric shock and equipment failure.



Do not use DC power cords other than the one enclosed or specified.

This may result in fire, electric shock and equipment malfunctions.



When connecting a DC power cord, be certain the positive and negative polarities are correct.

Reverse connection will result in equipment damage.



When transmitting, keep the transceiver at least 5.0 mm (3/16 inch) away from your body.

Use only the supplied antenna. Do not use modified or damaged antennas.



Disconnect the power cord and connection cables before installing separately sold accessory items.

This may result in fire, electric shock and equipment failure.



Follow the instructions provided when installing items sold separately.

This may result in fire, electric shock and equipment failure.



Use only the provided or specified screws.

Using screws of a different size, may result in fire, electric shock and component damage.



Do not place the transceiver in a confined space, such as a bookshelf which is not ventilated well.

This may result in overheating and fire, electric shock and equipment failure.



Do not operate the transceiver on a carpet or a blanket.

This may result in overheating and fire, electric shock and equipment failure.



If a foreign substance is spilled into the transceiver, turn it OFF immediately and remove the power plug from the outlet.

If used as it is, a fire, electrical shock, or damage may result.



CAUTION



Do not place the transceiver on an unsteady or sloping surface, or in a location with extreme vibration.

The transceiver may fall or drop, resulting in fire, injury and equipment damage.



Do not place this transceiver in a humid or dusty place.

A fire or failure may result.



Do not use the transceiver near the radio relay equipment.

Transmissions may affect radio communication.



Do not wipe the case using thinner and benzene etc.

Use only a soft, dry cloth to wipe stains from the case.



Do not throw the transceiver, or subject it to strong impact forces.

Physical abuse may result in component damage and equipment failure.



If the transceiver will not be used for an extended period, turn it OFF and remove the battery pack for safety.



Keep magnetic cards and videotapes away from the transceiver.

The data recorded on cash cards or videotapes may be erased.









Do not place this transceiver in direct sunlight or near a heater.





The case may be deformed or discolored.



Do not operate the transceiver near the TV or radio.

Radio disturbance can occur in the transceiver, the TV, or the radio.

-  **Be sure to check with the manufacturer of any hybrid or fuel-saving automobile regarding use of the transceiver in that car.**
Noise generated by an onboard electrical device (inverter, etc.) can disrupt the normal operation of the transceiver.
-  **Do not transmit near the television and radio.**
Transmissions may cause electromagnetic interference.
-  **While transmitting, keep the antenna as far from you as possible.**
Long-time exposure to electromagnetic waves may have a negative impact on your health.
-  **Do not dangle or throw the transceiver by holding its antenna.**
This may injure others and may also result in damage and failure of the transceiver.
-  **Do not use the transceiver in a crowded place.**
The antenna may strike others and result in an injury.
-  **Keep this product out of the reach of children.**
Injury to the child, or damage to the transceiver may result.

-  **Do not use any products other than the specified options and accessories.**
Failure or miss operation may result.
-  **Install the hand strap and belt clip securely.**
Improper installation may cause the FT5DR/FT5DE to fall or drop, resulting in an injury or damage.
-  **This product has a waterproof structure and conforms to “IPX7” when the included antenna and battery pack are installed and rubber caps are securely attached to the MIC/SP jack, EXT DC IN jack, and DATA terminal. If this transceiver gets wet, dry it with a soft cloth, do not leave it exposed to the moisture.**
Exposure to excessive moisture may degrade the transceiver performance, shorten its life, or cause a failure or electrical shock.
-  **Before discarding a depleted battery pack, affix tape or insulating covering to its terminals.**
-  **Do not use at extremely low atmospheric pressure.**

About Waterproofing Feature Conforming to IPX7

When the included antenna and battery pack are installed and the MIC/SP jack, EXT DC IN jack, DATA terminal, and microSD slot are securely covered with rubber caps, this product is moisture and splash resistant. To ensure continued waterproofing protection, be sure to check the following points before use.

- Check for damages, deterioration, and dirt.
Antenna rubber, key switch rubber, MIC/SP jack, EXT DC IN jack, DATA terminal, microSD slot rubber cap, and battery pack joint.
- Cleaning
When this product is contaminated with seawater, sand, or dirt, rinse with fresh water, and then wipe with a dry cloth immediately.
- Recommended maintenance interval
To ensure continued water resistance and optimal performance, it is recommended that maintenance be performed annually, or when any damage or deterioration is found. Note that the maintenance service is subject to fees.
- Do not immerse this product in the following liquids:
Sea, pool, hot spring, water containing soap, detergent, or bath additive, alcohol, or chemicals.
- Do not leave this product for an extended time in the following places:
Bathroom, kitchen, or humid place
- Other precautions
Since this product is not totally waterproof, it cannot be immersed in water.

Supplied Accessories and Options

Supplied Accessories

- Rechargeable Li-Ion Battery Pack (7.2V, 2,200mAh) **SBR-14LI**
- Battery Charger **SAD-25**
- Antenna
- Belt Clip
- Quick Release Holster **SHB-26BK**
- USB Cable
- Operating Manual (This Manual)
- SBR-14LI Manual
- Battery Pack protective cap



If any item is missing, contact the dealer from which you purchased the transceiver.

Available Options

- Speaker Microphone with Snapshot camera **MH-85A11U**
- Speaker / Microphone **SSM-17A**
- Earpiece Microphone **SSM-57A**
- VOX Headset **SSM-63A**
- Bluetooth® Headset **SSM-BT20**
- Microphone Adapter **CT-44**
- DC Cable with and Cigarette-Lighter Plug **SDD-13**
- DC Cable **E-DC-6**
- Quick Release Holster **SHB-26BK**
- Soft Case **SHC-40**
- 3x "AA" Cell Battery Case **FBA-39**
- Li-Ion Battery Packs (7.2V, 2,200mAh) **SBR-14LI**
- Li-Ion Battery Packs (7.4V, 1,100mAh) **FNB-101LI**
- Battery Charger **SAD-25**
- Rapid Charger **SBH-52 or CD-41**
- WIRES-X Connection Cable Kit
- Cloning Cable **CT-168**
- PC Connection Cable **CT-169**
- Data Cable **CT-170**
- Data Cable (2.5) **CT-176**
- Belt Clip **SHB-13**
- BNC-to-SMA Adapter (BNCJ-SMAP) **CN-3**

Preparation

Installing the Antenna

Turn the antenna clockwise until it is secured.



- Do not hold or twist the upper part of the antenna when installing or removing it. To do so may break the conductors inside the antenna.
- Do not key the transmit without installing the antenna. The transmitter components may be damaged.

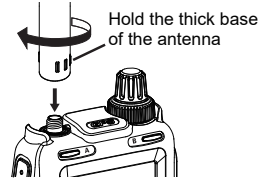

Installing the Battery Pack

1. Insert the bottom tabs of the battery pack in the slots on the back side lower part of the transceiver.
2. Push the battery in until the battery latches click securely.



Charge the battery pack before using the transceiver for the first time after purchase, or when it has not been used for a long period time.



Risk of explosion if battery is replaced by an incorrect type. Dispose of used batteries according to the instructions

Battery Latches

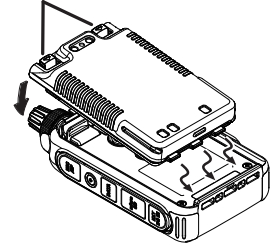

● Removing the Battery Pack

While pressing down the latches, remove the battery pack.

Attaching the Quick Release Holster

Attach the quick release holster using the supplied screws (two).

Supplied screws (black)
for the Quick release Holster

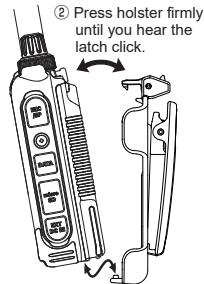
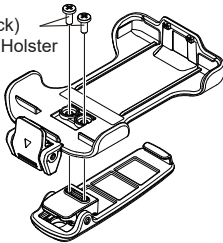

① Insert the bottom tabs of the Quick Release Holster in the slots on the bottom of the FT5DR/DE

Attaching the Belt Clip

Attach the belt clip using the supplied screws (two).

Supplied screws (silver)
for the Belt Clip

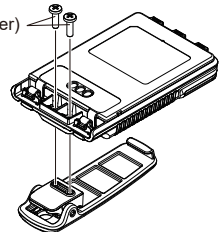

Be sure to use the supplied screws when attaching the belt clip. If any other screws are used, the belt clip cannot be secured firmly to the battery pack and the transceiver may drop off together with the battery pack; the transceiver and battery pack may fall off, breakage and other damage.

Charging the Battery Pack

Charging the Battery Pack using the Battery Charger

Using the supplied battery charger, it takes about 9 hours* to charge the SBR-14LI battery pack fully.

*Depending on the battery status, the charging time might be increased

1. Referring to the figure at the right, connect the battery charger plugs.

When the battery is being charged, the TX/BUSY Indicator of the A-band lights red, and “Now Charging” is displayed. The charge level is indicated by a bar graph.

2. When charging is completed, the display will change to indicate “CHGFUL” and the TX/BUSY Indicator will light green.

While the transceiver power is ON, “” will appear on the display.

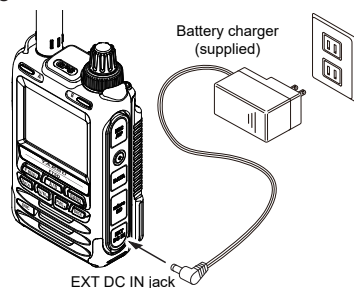

In the USA Version, the TX/BUSY LED is not lit when charging or when charging is complete. When the charge is complete, the transceiver turns OFF after 3 minutes.



- If “CHGERR” appears on the LCD during the charging and the battery pack is not charged after a lapse of 10 or more hours, stop charging the battery pack immediately. The battery pack is presumed to be at the end of its service life, or defective. In this case, replace the battery pack with a new one.
- Charge the battery pack within the temperature range from +41°F to +95°F (+5°C to +35°C).

Charging the Battery Pack using the Rapid Charger

The optional Rapid Charger requires about 5 hours to charge the SBR-14LI battery pack.

1. Insert the DC plug from the Battery Charger into the DC jack on the Rapid Charger rear panel, then plug the Battery Charger into the AC line outlet.
2. Place the transceiver with battery pack attached or the battery pack alone into the Rapid Charger, charging will start and the red LED (CHARGING) of the Rapid Charger will light up.
3. When charging is complete, the red “CHARGING” indicator turns OFF and then the green “FULL” indicator will light.



The LED of the Rapid Charger may blink red before charging is complete, but this is not a malfunction.

● Approximate Operating Time and Remaining Charge Level Indication

Approximate operating time for the transceiver with the fully charged battery pack or new AA alkaline batteries is as follows:

	Band in Use Digital: OFF	Battery pack SBR-14LI	Battery pack FNB-101LI	Battery case FBA-39
Amateur Band	144 MHz Band	Approx. 9.5 hours	Approx. 4.5 hours	Approx. 12 hours
	430 MHz Band	Approx. 8 hours	Approx. 4 hours	Approx. 11 hours

The battery charge level calculations are based on an operating cycle of: Transmitting 6 seconds (5 W): Receiving 6 seconds (VOL Level 16): Stand By 48 seconds (RX SAVE 1:5). The actual times the transceiver will operate as indicated in the above table, varies depending on use, conditions, ambient temperature, etc.

External Power Supply

Connecting an External Power Supply for Use in a Vehicle

The optional DC Cable with Cigarette-Lighter plug (SDD-13) allows power to be supplied from a motor vehicle type cigarette lighter socket.

Connecting to an External Power Supply Using a Power Cable

The optional DC cable (E-DC-6) allows the transceiver to be connected to an external DC power supply.

Using a microSD Memory Card

Using a microSD memory card with the transceiver allows the following functions.

- Backing up the transceiver data and information
- Saving memory information
- Voice recording/playback
- Saving GPS log data
- Saving image data captured with the optional camera-equipped microphone (MH-85A11U)
- Saving messages downloaded with the GM function or WIRES-X function

Usable microSD Memory Cards

This transceiver only supports the following capacity of microSD and microSDHD memory cards.

• 2GB · 4GB · 8GB · 16GB · 32GB



- microSD memory cards formatted on other devices may not properly save information when used with this transceiver. Format microSD memory cards again with this transceiver when reusing memory cards formatted with another device.
- Do not remove the microSD memory card or turn the transceiver OFF, while saving data to a microSD memory card is in progress.

Mounting and Dismounting microSD Memory Card

1. Press and hold the Power (Lock) switch to turn the transceiver OFF.
2. Insert the microSD memory card into the card slot until a clicking sound is heard (as shown in the figure at the right).
3. Press and hold the Power (Lock) switch to turn the transceiver ON.

When the memory card is properly detected, "SD" lights on the display.

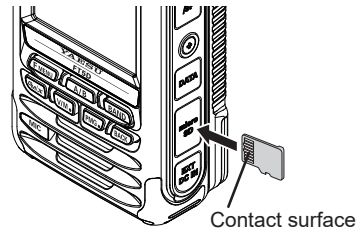

● Removing the microSD memory card

To remove the microSD memory card (inserted in step 2 above), push the memory card in until a clicking sound is heard, then remove the memory card.

Formatting a microSD Memory Card

Format a new microSD memory card following the steps below before use.



- Formatting a microSD memory card erases all data saved on it. If you are going to format the microSD memory card you are using, be sure to check the data saved on it before formatting.
 - The microSD memory cards used in other devices may not be recognized by the FT5DR/DE, or it may take an abnormally long time to read or write. So normally, they may not be useable. Reading and writing of the microSD cards may be improved by using the SD memory card formatter provided by the SD Association. The SD memory card formatter can be downloaded from this URL (<https://www.sdcard.org/downloads/formatter/>).
-

1. Press and hold the **[F MENU]** key.
The “SETUP MENU” screen appears.
2. Touch **[SD CARD]**.
3. Touch **[4 FORMAT]**.
“FORMAT?” appears on the LCD.
4. Touch **[OK]** twice.
Initialization starts and “Waiting” appears.
 - To cancel formatting, select **[CANCEL]**.
5. When formatting is completed, a beep sounds and “COMPLETED” appears on the LCD.

Operation

Turning the Transceiver ON

Press and hold the Power (Lock) switch to turn the transceiver ON.

● Turning the transceiver OFF

Press and hold the Power (Lock) switch again to turn the transceiver OFF.

● Inputting the call sign

The first time the transceiver is turned ON after it is purchased; input your own call sign.

1. Press the **[F MENU]** key to proceed to the call sign input screen.
 - When the transceiver is turned ON the second time, and subsequently, the opening screen appears followed by the frequency screen.
 - Input call sign may be changed from Setup Menu **[CALLSIGN]** (page 68).
2. Input the call sign (toggle the alphabet input screen, and the number input screen when necessary).
3. Save the entered call sign:
4. Press the **PTT** switch or press and hold the **[F MENU]** key.



- Up to 10 characters (letters, numbers, and symbols) can be entered.
- Characters that may be inputted for the call sign are the numbers 0-9, letters A-Z (upper case), the hyphen and the slash.

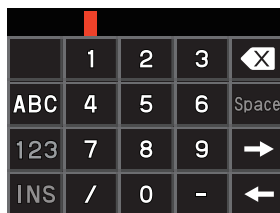
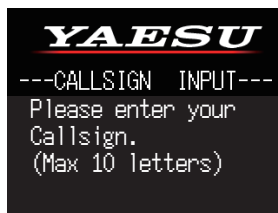
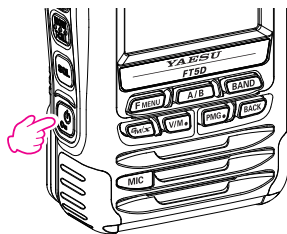

Adjusting the Volume Level

1. Rotate the VOL knob to adjust the volume to a comfortable level.
 - The transceiver volume levels for the A-band and B-band are adjusted separately.
 - The transceiver volume levels for the AM broadcast band and the FM broadcast band are adjusted separately.

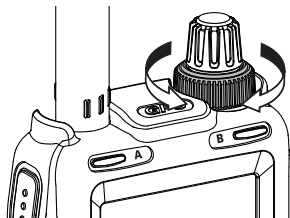

The fidelity (audio pitch) of the received audio in C4FM digital mode can be emphasized in the high range or the low range. Use Set Mode **[TX/RX] → [DIGITAL] → [5 AUDIO PITCH]** (see page 63)

Adjusting the squelch setting

The squelch level may be adjusted to mute the background noise when no signal is present.

1. Press the SQL key and then rotate the VOL knob to adjust to a level at which the background noise is muted.

SQL  appears on the display.

- The transceiver squelch levels for the A-band and B-band are adjusted separately.
 - The transceiver squelch levels for the AM broadcast band and the FM broadcast band are adjusted separately
2. After the adjustment, press the SQL key again, or wait for about 3 seconds to save the setting.



- The default setting is “1” (setting “2” is for FM broadcast band).
- When the squelch level is increased, the noise is more likely to be silenced, but it may become more difficult to receive weak signals.

Toggle the Operating Band

Normally, both operating bands are displayed on the top half and bottom half of the transceiver touch screen. This is Dual band.

With one of the bands selected, change the frequency and radio operating mode.

- The selected band (displayed in white letters) is called Operating band.
- The other band (displayed in gray letters) is called Sub-band.
- Each time pressing the [A/B] key toggles the operating band.
- The desired operating band may also be selected by touching the frequency display.

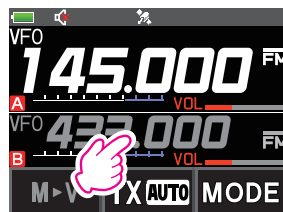
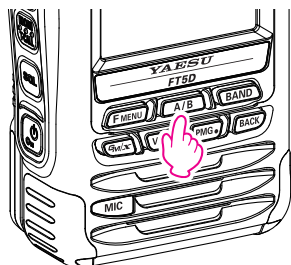

In dual receive mode, when receiving a signal in the operation band, the received audio in the sub-band is automatically muted. For additional details, refer to the Advanced Manual which may be downloaded from the Yaesu website.

● Switching the Mono-band Screen

Pressing and holding the [A/B] key will switch between Mono-Band and Dual-Band displays. In Mono-Band mode, only the operating band is shown.

- Each time pressing the [A/B] key toggles the operating band.

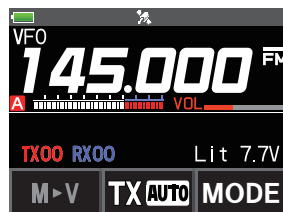

To change the font color of the frequency display on the operation band to Blue or Red, use Set Mode: [DISPLAY] → [7 DISPLAY COLOR] (see page 63)

Selecting a Frequency Band

Press the **[BAND]** key to select the desired frequency band.

1. Press the **[F MENU]** key to display the function menu screen.
2. Press the **[BAND]** key to switch the frequency bands in reverse order.
3. Press the **[BACK]** key to return to the previous screen.

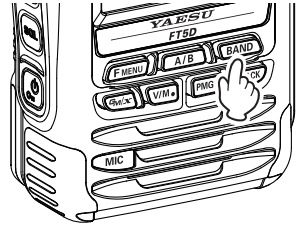

i Unwanted frequency bands can be set in the setup menu so they are not displayed in the A-band or the B-band. Use Set Mode **[CONFIG] → [22 BAND SELECT]** (see page 66).

The frequency bands that can be selected for each of the A and B bands are as follows:

● Frequency bands on A-band

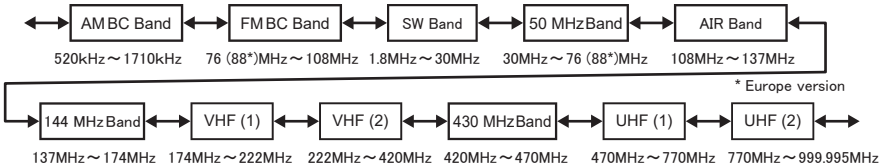

● Frequency bands on B-band

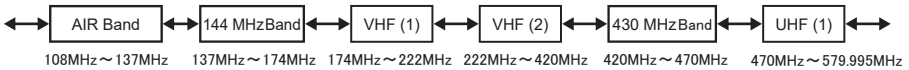

Tuning to a Frequency

● DIAL knob

1. Press the **[F MENU]** key to display the function menu screen.
2. Rotating the **DIAL** knob, the frequency will change in 1 MHz steps.
3. Press the **[BACK]** key to return to the previous screen.

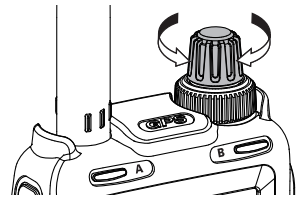

● The numeric keys

1. Touch and hold the frequency displayed on the LCD. The numeric keypad appears.
2. Enter the frequency using the numeric keys.

Example: To input 145.520 MHz

[1] → [4] → [5] → [5] → [2]

Example: To input 430.000 MHz

[4] → [3] → [ENT]

i When entering a frequency using the numeric keys, it may be canceled by pressing the **PTT** switch or any key.

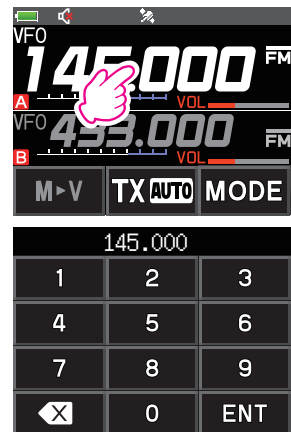

Changing the Frequency Step

The **DIAL** knob rotation frequency step may be changed. Normally, the factory default setting will provide a good frequency step.

1. Press and hold the [**F MENU**] key, then touch [**CONFIG**].
2. Touch [**18 STEP**] then rotate the **DIAL** knob to change the frequency step.
3. Press the **PTT** switch to save the setting and return to normal operation.



- In the default setting, of the frequency step is set to “AUTO”, which automatically provides a suitable frequency step according to the frequency band.
- The frequency steps that can be set differ depending on the frequency band.

Selecting the Communication Mode

● Using AMS

The FT5DR/DE transceiver is equipped with the AMS (Automatic Mode Select) function which automatically selects the communication mode corresponding to the received signal.

To utilize the AMS function, touch [**MODE**] repeatedly to display “**FM**”*, “**DN**”* or “**VW**”* on the display. After receiving the signal, “**FM**” of “**FM**” will change to indicate the mode of the received signal.

*The display differs depending on the received signal.

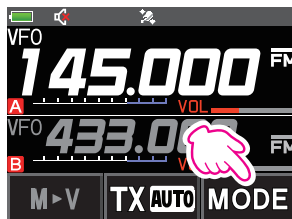

The bar at the top of the mode display indicates that the AMS feature is on.

● Setting the transmit mode when using the AMS function

The AMS function will automatically set the receiver to the mode of the received signal, but the transmission mode may be fixed regardless of the received mode.

1. Touch [**TX AUTO**]* to tune to the desired transmit mode as follows.

*The display differs depending on the transmit mode.

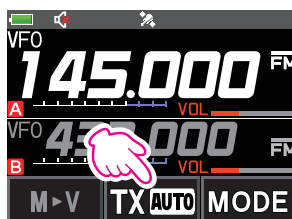

Transmit Mode	Receive and Transmit
TX AUTO (default)	Receive: Automatically selects the communication mode of transmission according to the signal being received. Transmit: Transmits automatically in the communication mode selected by the AMS function.
TX FM	Receive: Automatically selects the communication mode of transmission according to the signal being received. Transmit: Always transmits in the analog FM mode.
TX DN (TX DIGITAL)	Receive: Automatically selects the communication mode of transmission according to the signal being received. Transmit: Always transmits in the DN mode.

Fixing the Communication Mode

To fix the transmission mode for operation, touch [MODE] to switch the communication mode.

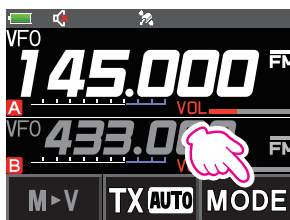

Communication Mode	Icon	Description of Modes
V/D Mode (Voice/Data simultaneous transmission mode)	DN	This is the standard digital mode. Calls are less prone to interruptions caused by detection and correction of the received digital voice signal.
Voice FR Mode*1 (Voice Full Rate Mode)	VW *1	High speed data communication using entire 12.5 kHz band. Enables high-quality voice communication.
FM Mode	FM	Analog communication using FM mode.
AM Mode (receive only)*2	AM	The AM mode for receive only.
Data FR Mode (High speed data Communication Mode)	DW	High speed data communication mode using the entire 12.5 kHz bandwidth for data communication. Automatically switches to this mode during image transmission.

*1 When the Setup Menu [TX/RX] → [2 DIGITAL] → [4 DIGITAL VW] is set to “ON” (factory default is “OFF”), the Voice FR mode (VW) may be selected.

*2 When the Setup Menu [TX/RX] → [1 MODE] → [3 RX MODE] is set to “AUTO” (factory default setting), AM mode is automatically selected within the AIR band (108 - 136.995 MHz).

Transmission

1. While pressing and holding the **PTT** switch, speak into the microphone.
The TX/BUSY indicator will glow red during transmission.

 If the PTT switch is pressed when a frequency other than the amateur ham radio band is selected, an alarm tone (beep) will be emitted and “TX INHIBIT” appears on the LCD, disabling transmission.

2. Release the **PTT** switch to return to receive mode.
When receiving a signal, the TX/BUSY Indicator lights according to the receive mode.

Receive Band	TX/BUSY LED
C4FM receiving	Blue
Analog FM receiving	Green

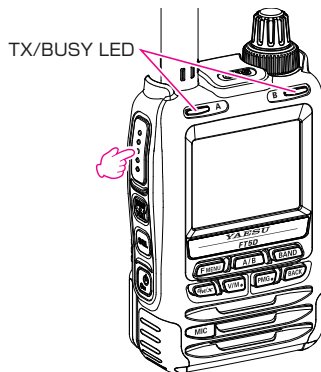

The TX / BUSY LED blinks while receiving a signal that does not match the DG-ID or similar tones, and when the sub-band audio is muted with the sub-band mute feature.

 If transmission is continued for a long period, the transceiver overheats and the high temperature protection function is activated. As a result, the transmitting power level is automatically set to Low Power. If transmission continues while the high temperature protection function is active, the transceiver will be forcibly returned to the receive mode.

Changing the Transmit Power Level

1. Press the **[F MENU]** key, then touch **[TXPWR]**.
2. Rotate the **DIAL** knob to select one of the following transmit power levels:

TX PO Level	PO Meter
HIGH (5 W)*	
LOW3 (2.5 W)	
LOW2 (1 W)	
LOW1 (0.1 W)	

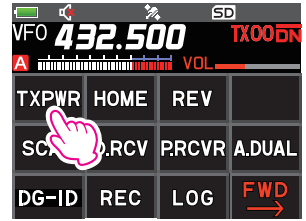

*The default setting. When the optional alkaline battery case (FBA-39) is used, only LOW2 (about 0.9W) and LOW1 (about 0.3W) can be selected.

3. Press the **PTT** switch to save the setting and return to the normal operation.



The transmit power level may be set separately for each frequency band.

Locking Keys and DIAL knob

1. Press the Power (Lock) switch, “**LOCK**” is displayed on the display for one second, the “” icon appears on the LCD, and then the keys and **DIAL** knob are locked.

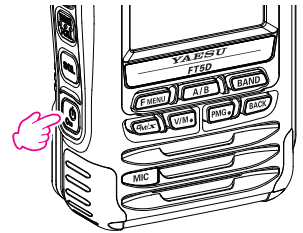

- The keys, the **DIAL** knob, and the **PTT** switch may be selected to be locked using Setup Menu **[CONFIG] → [9 LOCK]**. The default setting is the “**KEY&DIAL**” (the keys and the **DIAL** knob are locked).
- The **[MONI/T-CALL]** key, **[SQL]** key and the **VOL** knob cannot be locked.

2. Press the **POWER** (Lock) switch again, “**UNLOCK**” will be displayed on the Display and keys and the **DIAL** knob are unlocked.

Using the convenient Digital C4FM feature

About the Digital Group ID (DG-ID) feature

1. Digital Group ID (DG-ID) function allows communications with only the specific group members using the two-digit ID numbers. The desired DG-ID number from 00 to 99 is set in advance by all the group members. This ID number may be set separately for transmit and receive, when the same ID number is set for both transmit and receive, only group members with the same ID number will be heard. This feature may be used to communicate only with group members that have the same DG-ID number. The GM function may also be utilized to automatically monitor whether or not group member stations with the same DG-ID number are operating within communication range.

The DG-ID number 00 detects signals with all ID numbers. Normally setting the ID number to "00" for both transmit and receive will permit reception of the signals from all other stations using the digital C4FM mode, regardless of the transmit DG-ID number settings of the other stations.

Also note that when the receive DG-ID number of your transceiver is set to a DG-ID number other than "00", received signals that do not have the same DG-ID number may not be heard.

2. When accessing the C4FM digital repeater controlled by the DG-ID number, set the transmit DG-ID number of the FT5DR/DE to that of the repeater input. Even in that case, if the receive DG-ID number of the FT5DR/DE is set to "00", all the downlink signals from the repeater may be received.

Communicating with the DG-ID feature



- Digital C4FM mode transceivers compatible with the DG-ID function are required in order to utilize this function.
- If the firmware is not compatible with the DG-ID function, update the latest firmware to use the DG-ID function. The latest firmware is available on the YAESU website.

Setting the transmit and receive DG-ID number to "00" for communicating with all other stations using C4FM digital mode

1. Press the **[F MENU]** key, and touch **[DG-ID]**.
If **[DG-ID]** is not displayed, touch **[BACK ←]** to display **[DG-ID]** and then touch it.
2. The DG-ID number setting screen will be displayed.
If the transmit DG-ID (DG-ID TX) number is not set to "00", press the **[F MENU]** key then rotate the **DIAL** knob to set "00", and then press the **[F MENU]** key.
3. Rotate the **DIAL** knob to select the receive DG-ID (DG-ID RX).
4. If the receive DG-ID number is not set "00", press the **[F MENU]** key then rotate the **DIAL** knob to set "00", and then press the **[F MENU]** key.

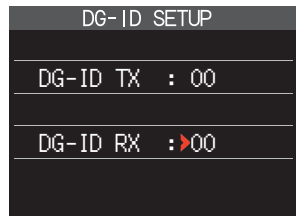
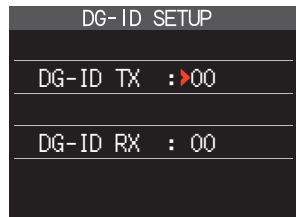

5. Press the **[BACK]** key or the **PTT** switch to save the setting and return to the normal operation.
The setting is complete.

6. To check whether or not other stations are operating within communications range, press the **[GM/X]** key to turn the GM (Group Monitor) function ON.
 - The other stations also need to turn the GM (Group Monitor) function ON.
 - Refer to the separate Operating Manual GM Edition for details on how to use the GM function (download the manual from our YAESU website).
7. Press the **[GM/X]** key to turn the GM (Group Monitor) function OFF and return to the normal operation.

 - While setting the DG-ID number, pressing and holding the **[GM/X]** key will set the transmit and the receive DG-ID numbers to "00".



- If the receive DG-ID is set to a number other than "00", only signals with that DG-ID will be received. Normally, set the receive DG-ID number to "00" except when communication is desired only with group members.
 - The transmit and receive DG-ID default number is set to "00".
-

Communicating only with the specific members by setting the DG-ID number except for "00"

Example: Set the DG-ID number of to "50"

1. Press the **[F MENU]** key, and touch **[DG-ID]**.
 If **[DG-ID]** is not displayed, touch **[BACK ←]** to display **[DG-ID]** and then touch it.
 The DG-ID number setting screen will be displayed.
2. Press the **[F MENU]** key, then rotate the **DIAL** knob to set the transmit DG-ID (DG-ID TX) to "50".
3. Press the **[F MENU]** key again, then rotate the **DIAL** knob to select the receive DG-ID (DG-ID RX).
4. Press the **[F MENU]** key, then rotate the **DIAL** knob to set the receive DG-ID (DG-ID RX) to "50".

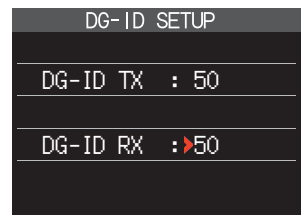
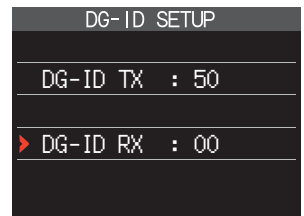
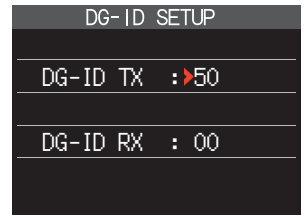
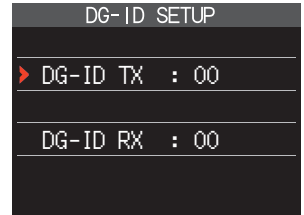

- Press the **[BACK]** key or the **PTT** switch to save the setting and return to the normal operation.
- Press the **[GM/X]** key to turn the GM (Group Monitor) function ON and check whether or not other stations that are operating on frequency, with the GM (Group Monitor) function ON, and have the same GD-ID number setting, are in the communication range.
 - The other stations also need to turn the GM (Group Monitor) function ON.

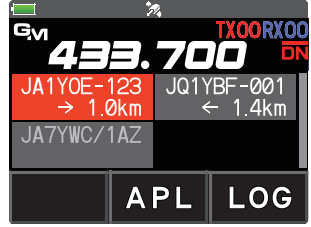

- Press the **[GM/X]** key to turn the GM (Group Monitor) function OFF and return to the normal operation.

- While setting the DG-ID number, pressing and holding the **[GM/X]** key will set the transmit and the receive DG-ID numbers to "00".
- If the receive DG-ID is set to a number other than "00", only signals with that DG-ID will be received. Normally, set the receive DG-ID number to "00" except when communication is desired only with group members.

For example, if the transmit and receive DG-ID numbers of group members are all set to "50", communications from other DG-ID numbers is not received and only the group members setting the same DG-ID numbers may communicate. Also, the other stations setting the receive DG-ID to any number except for "00" may not receive the signals of your stations.

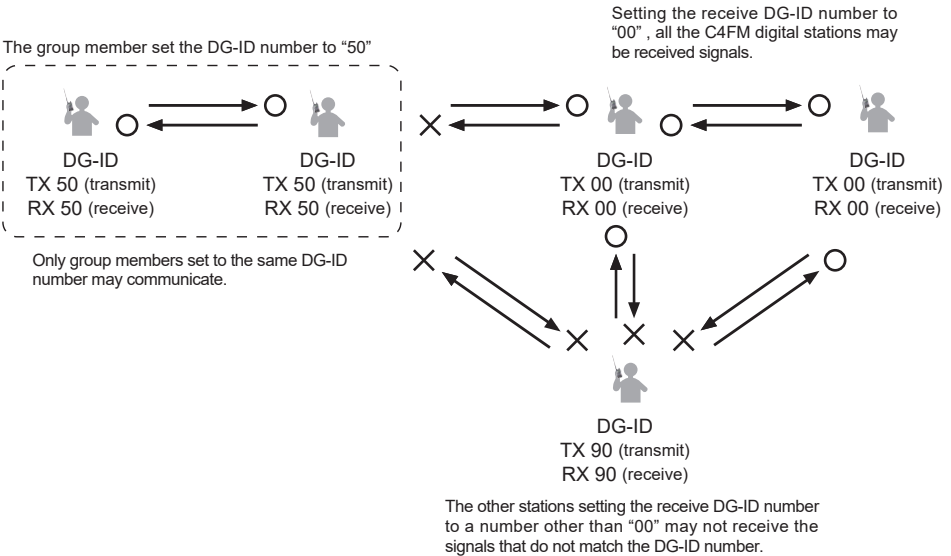

Communicating Via the Repeater

The transceiver includes an ARS (Automatic Repeater Shift) function which sets the repeater operation automatically when the receiver is tuned to the repeater frequency.

1. Set the downlink (output) frequency from the repeater.
2. “**□**” or “**+**” and “**TN**” icons may automatically appear above the frequency.
3. Speak into the microphone while pressing and holding the **PTT** switch.

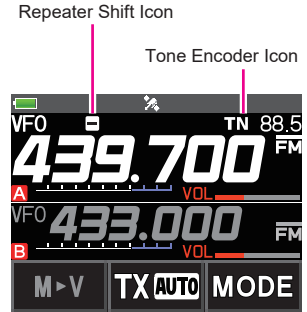

● The reverse state

The “reverse” state temporarily reverses the transmit and receive frequencies. This allows checking to find if direct communication with the other station is possible.

1. Press the **[F MENU]** key, then touch **[REV]**.
If **[REV]** is not displayed, touch **[BACK ←]** to display **[REV]** and then touch it.
 - The transmit and receive frequencies are temporarily reversed (“reverse” state).
 - In the “reverse” state, the “**□**” or “**+**” blinks on the display.
2. Press the **[F MENU]** key, then touch **[REV]** to exit from the “reverse” state.



- The ARS function may be set to OFF in the Setup Menu **[CONFIG] → [14 RPT ARS]**.
- The repeater settings may be changed from the Setup Menu.
Setup Menu **[CONFIG] → [15 RPT SHIFT]**: Allows setting the repeater shift direction.
Setup Menu **[CONFIG] → [16 RPT SHIFT FREQ]**: Allows changing the repeater shift offset.
Setup Menu **[SIGNALING] → [12 TONE SQL FREQ]**: Allows setting the tone encoder frequency.



● Tone Calling (1750 Hz)

If the transceiver is an FT5DE (European version), press and hold in the MONI/T-CALL switch (just below the PTT switch) to generate a 1750 Hz burst tone to access the European repeater. The transmitter will automatically be activated, and a 1750 Hz audio tone will be superimposed on the carrier. Once access to the repeater has been gained, you may release the switch, and use the switch for activating the transmitter thereafter. If you need to access the repeaters which require a 1750 Hz burst tone for access by the FT5DR (USA/Asian versions), you can set the switch to serve as a “Tone Call” switch instead. To change the configuration of this switch, use Set Mode **[CONFIG] → [10 MONI/T-CALL]**.

Using the Memory

The FT5DR/DE transceiver incorporates a large number of memory channels that can register the operating frequency, communication mode, and other operational information.

- 900 Memory Channels
- 99 Skip Search Memory Channels
- 11 Home Channels
- 50 pairs PMS Memory Channels
- Preset Receiver Memory Channels include the International VHF marine radio (57 channels) and Worldwide Wide Broadcasts (89 channels)

With the memory auto grouping (MAG) function, memory channels only in the same frequency band may be automatically recalled as a group.

The operating frequency and other operational information can be registered to each regular memory channel, home channel, or PMS memory channel:

- Operating frequency
- Operation Mode
- Frequency Step
- Transmitter output
- Memory tag
- Repeater Shift
- TX/RX DG-ID
- Tone information
- DCS information
- ATT
- Specified Memory Channel
- FM mode bandwidth
- S meter squelch
- Memory channel skip information

Memory channels can be sorted and registered into memory banks according to the intended use. The transceiver allows using 24 types of memory banks. A maximum of 100 memory channels can be registered in each memory bank.

Note

Back up the stored contents to a microSD memory card. For details on saving a backup onto a microSD memory card, refer to the Advanced Manual which may be downloaded from the Yaesu website.

Registering to Memory Channels

1. Set the frequency and the communication mode to be registered to a memory channel.
2. Press and hold **[V/M●]** key.
The memory channel number blinks.
The memory channel number next to the previously recalled memory channel is automatically selected.
3. Rotate the **DIAL** knob to select the desired channel number.
 - The channel number of a memory channel that has already been written or deleted blinks in red.
 - Touch **[▶▶]**, and rotate the **DIAL** knob to fast-forward 10 channels at a time. Touch **[▶▶]** again, to cancel fast-forward.
4. Press the **[V/M●]**.
 - If you attempt to register a frequency to a memory channel that already contains frequency data, "OVERWRITE?" will appear on the LCD. Touch **[OK]** twice to overwrite the memory channel.
 - The memory tag input screen will be displayed on the LCD.
5. Input the memory tag.
If not entering a name tag → proceed to step 6.

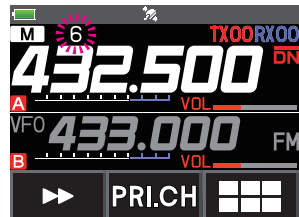
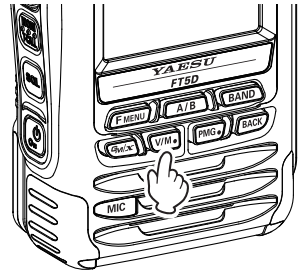

- Use the numeric keys to input the characters.
 - Touch  to move the cursor to right in the text input area.
 - See “Text input screen” on page 70 to input a memory tag.
6. Press the **PTT** or **[V/M●]** key, to save the data to memory and return to normal operations.

Recalling a Memory Channel

1. Press the **[V/M●]** key.
The memory channel most recently used appears on the display.
2. Rotate the **DIAL** knob to select the desired memory channel.
 - Press the **[F MENU]** key, and rotate the **DIAL** knob to fast-forward 10 channels at a time. Press the **[F MENU]** again, to cancel fast-forward.
 - Touch and hold **[M>V]** to transfer the memory contents to the operating band VFO.
3. Press the **[V/M●]** key to exit the memory mode, and return to the VFO operation.











- When a tagged Memory channel is recalled, both memory tag and frequency will be displayed. (Memory tag is displayed only on the operating band.)
- Touch the frequency display of the operating band to switch between memory tag display and normal frequency display.
- On the B-band, the: “AM broadcast band”; “FM broadcast band”; “Shortwave broadcast band”; “50 MHz band” and “UHF(2)” cannot be called.

Recall only memories in the same frequency band (Band) using the memory auto grouping (MAG) function

With the memory auto grouping (MAG) function, only memory channels in the same frequency band (Band) can be called.

In the memory mode, each time the **[BAND]** key is pressed, only memory channels of the specified frequency band are automatically recalled as a group, as shown below:

Group Name	Selectable Memory Channels
ALL 	All memory channels*.
AIR 	AIR band memory channels only.
144MHz 	144 MHz band memory channels only.
430MHz 	430 MHz band memory channels only.
AM 	AM broadcast band* memory channels only.
FM 	FM broadcast band* memory channels only.
SW 	Shortwave broadcast band* memory channels only.
OTHER 	50 MHz band*, VHF(1), VHF(2), UHF(1) and UHF(2)* memory channels only.

*On the B-band, the: “AM broadcast band”; “FM broadcast band”; “Shortwave broadcast band”; “50 MHz band” and “UHF(2)” cannot be called.

The  icon is light, and the other icons blink when they are active.

Clearing Memories

1. Press and hold the [V/M●] key.
2. Rotate the **DIAL** knob to select the memory channel from which the data is to be cleared.
3. Touch [], then touch [M.DEL].
Confirmation screen “DELETE?” is displayed.
4. Touch [OK] twice to clear the memory channel.

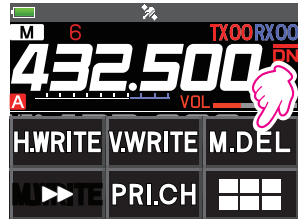

Data on Memory Channel One, Priority Channel, and the Home Channel may not be cleared.

Restored erased memory

1. Press and hold the [V/M●] key.
2. Rotate the **DIAL** knob to restore the channel.
3. Touch [].
4. Touch [M.REV] to restore the memory channel.

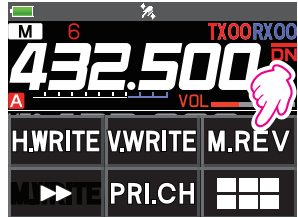

Using Memory Tag

Memory name tags, such as a call sign or broadcast station name may be assigned to the memory channels and home channels. Input a memory tag using up to 16 characters. Alphabetic characters (upper and lowercase), Numbers and Symbols may be entered to the memory name tag.

1. Press the [V/M●] key to enter Memory mode.
2. Rotate the **DIAL** knob to Recall the memory channel to assign the name.
To assign a name to a home channel, recall the desired home channel.
3. Press and hold the [FMENU] key, and then touch [MEMORY].
4. Touch [3 MEMORY NAME].
 - Use the numeric keys to input the characters.
 - Touch  to move the cursor to the right in the text input area.
 - See “Text input screen” on page 70 to input a memory tag.

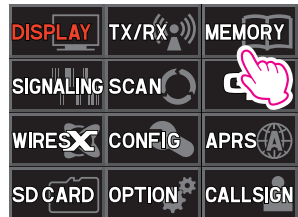

- When a memory tagged Memory channel is recalled, both the memory tag and the frequency will be displayed. (The Memory tag is only displayed on the operating band.)
- Touch the frequency display of the operating band to switch between memory tag display and normal frequency display of all memory channels.

Recalling the Home Channels

1. Press the [F MENU] key, and then touch [HOME].
If [HOME] is not displayed, touch [BACK ←] to display [HOME] and then touch it.
 - “HOM” and the home channel frequency of the currently selected band appears on the LCD.
 - Each time the [BAND] key is pressed, operation switches to the home channel of another frequency band.
2. Press the [V/M●] key, or press the [F MENU] key, and then touch [HOME] to return to the previous frequency.

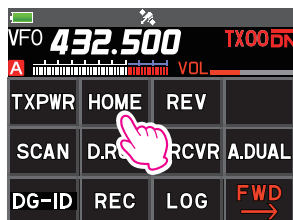

- While recalling the home channel, rotate the **DIAL** knob to transfer the home channel frequency to the VFO operating band.
- The home channel frequency can be set not to be transferred in the Setup Menu [CONFIG] → [8 HOME VFO] (page 65).



Changing the Home Channel Frequency

1. Set the frequency and the operating mode you want to store as a home channel.
2. Press and hold the [V/M●] key.
3. Touch [H.WRITE], and then touch [H.WRITE].
Confirmation screen “OVERWRITE?” is displayed.
4. Touch [OK] twice.
The memory tag input screen will be displayed on the LCD.
5. Input the memory tag.
If not entering a name tag → proceed to step 6.
 - See “Text input screen” on page 70 to input a memory tag.
6. Press the [V/M●] key, or press the PTT switch, to changed home channel frequency and return to normal operations.



For additional details on the following functions, refer to the Advanced Manual which may be downloaded from the Yaesu website.

Memory Channel List

All memory channels can be displayed and recalled from the list.

Split Memory

Two different frequencies, one for receive and another for transmit, can be registered to a memory channel.

Using Memory Bank

The transceiver allows using up to 24 memory banks to allow sorting and registering the channels in convenient groups.

Memory Only Mode

The transceiver may be placed into a Memory Channel Only mode, (which restricts the FT5DR/DE to operate only on the memory channels).

PMG (Primary Memory Group Activity Monitor)

If an often-used frequency is registered with your friends in a PMG (Primary Memory Group), it can be recalled that frequency immediately by pressing the **[PMG●]** key. The PMG function displays the registered frequency signal status (received signal strength) in a bar graph (activity monitor). You can instantly move to that channel simply by touching the bar graph (TOUCH & GO Operation).

The activity monitor can display up to 5 channels, but it is very convenient to register about 2 or 3 frequently used frequencies.

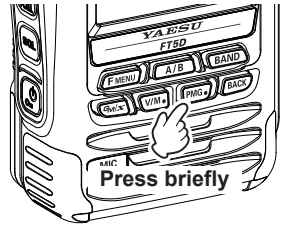

Example: When 3 frequencies are registered



When frequencies other than 108MHz to 580MHz (i.e.: shortwave broadcasting; AM/FM radio; 50MHz band; etc.) are registered to PMG, a gray bar graph is displayed. Touch the bar graph to switch to the receive frequencies and hear the signals.

① Register the frequency with PMG

You can register up to 5 current frequency channels to PMG by simply pressing and holding the **[PMG●]** key.

1. Set the frequency and the communication mode, or the memory channel you want to register in PMG.
2. Press and hold the **[PMG●]** key to register the current channel to PMG and display the activity monitor screen.
3. To continue registering additional frequencies, press the **[PMG●]** key or **[BACK]** key to return to the original screen, and then repeat steps 1 and 2 above.

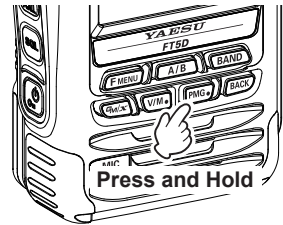

- If the memory channel is already registered, an error alarm will sound, and the channel will not register to PMG.
- Up to 5 channels can be registered in PMG. If you want to register a new frequency, cancel one of the registered frequencies and then register a new frequency.



When 1 frequency is registered

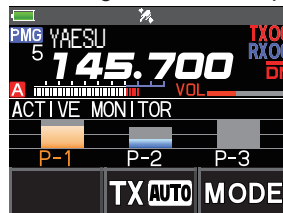

When 3 frequencies are registered

② Touch the bar graph to switch the frequency

1. Touch the bar graph on the screen.
 - The touched bar graph is displayed in orange and the receive is set to that frequency.
 - The receive frequency may also be changed by turning the **DIAL** knob.

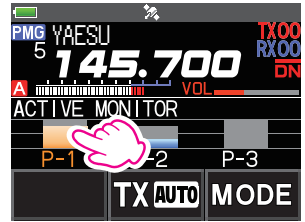

③ Unregister the channel (frequency) registered in PMG

1. Select the channel (frequency) to be unregistered by touching the bar graph or turning the **DIAL** knob.

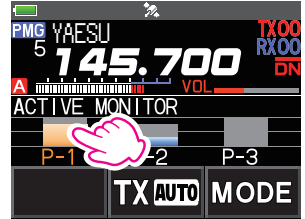

2. Press and hold the **[PMG●]** key to cancel the registration.
When the number of registered channels reaches zero, PMG will be canceled and the display will return to the original screen.

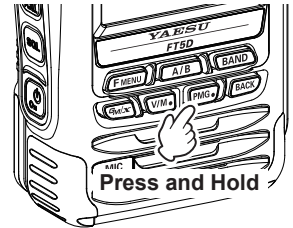

④ Disable the PMG function

Press the **[PMG●]** key or press the **[BACK]** key.
The display will return to the screen before starting PMG.

CAM (Channel Activity Monitor) function

Up to 10 groups with 5 channels each, of frequently used memory channels* may be registered, and then while receiving the current frequency, the status (signal strength) of the selected group of memory channels may be displayed. It is easy to identify on which channel the communication was made. When a memory channel on the graph is touched, it will become the center operating frequency, so communication with friends may begin immediately (TOUCH & GO Operation).

Memory channel tag
Memory channel number currently selected

CAM Group tag display
Touch the bar graph, it will be the transmit/receive frequency.

Currently selected memory channel (displayed in orange)

Display in gray even if the received signal is lost

CAM memory channel tag display

Gray bar graph is displayed for frequencies outside the frequency range (108 to 580 MHz) that can be displayed as a bar graph.

CAM Group selection

i When frequencies other than 108MHz to 580MHz (i.e.: shortwave broadcasting; AM/FM radio; 50MHz band; etc.) are registered to CAM, a gray bar graph is displayed. Touch the bar graph to switch to the receive frequencies and hear the signals.

① Register memory channel to CAM group

1. Press the **[F MENU]**, and then touch **[CAM]**.
 - If **[CAM]** is not displayed, touch **[FWD →]** to display **[CAM]** and then touch it.
 - The CAM screen is displayed.

i The CAM function only uses memory channels, while the PMG function can register both VFO frequencies and memory channels.

2. Touch **[GROUP]**, and then turn the **DIAL** knob to select the group (GROUP 01 to 10) to be registered.

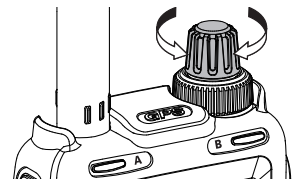
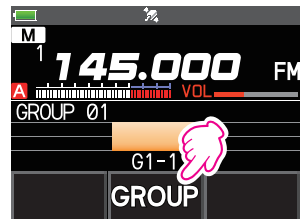
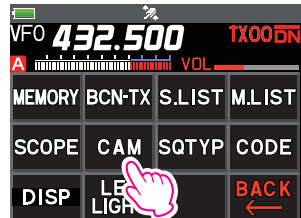

3. Touch **[EDIT]**.

- A list of memory channels registered to the CAM group is displayed.
- Press the **[V/M●]** key to switch between the memory tag screen and the frequency screen.



When the memory channel is displayed as a tag (name), press and hold the **[V/M●]** key to switch to the frequency display. Press and hold the **[V/M●]** key again to switch to the tag (name) display.

4. Rotate the **DIAL** knob to select the CAM memory channel to register.
5. Touch **[ADD]**.

CLUB CH LIST		
1	GROUP 01	
2	GROUP 02	
3	GROUP 03	
4	GROUP 04	
NAME	EDIT	CLEAR

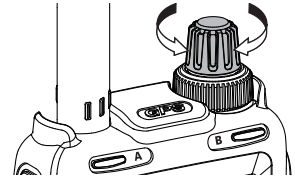

GROUP 01		
G1-1	1	145.00.00
G1-2	5	439.700.00
G1-3	6	432.500.00
G1-4	-----	----
	DEL	ADD

6. Rotate the **DIAL** knob to select the memory channel to register, and touch **[ENT]**.

- Repeat step 4 to 6 register multiple memory channels.
- Up to 5 channels can be registered in one group.
- The same memory channel cannot be registered twice in one group.
- Touch **[▶▶]**, and rotate the **DIAL** knob to fast-forward 10 channels at a time. Touch **[▶▶]** again, to cancel fast-forward.

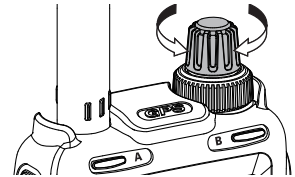

MEMORY CH LIST		
1	145.000.000	
2	439.700.000	
▶	3 145.620.000	
X	4 432.500.000	
▶▶	ENT	

7. Press the **[BACK]** key to return to the CAM screen.

② Using the CAM function

1. Press the [F MENU], and then touch [CAM].
 - If [CAM] is not displayed, touch [FWD →] to display [CAM] and then touch it.
 - The CAM screen is displayed, and the signal strength of the channel that received the signal is displayed as a bar graph.

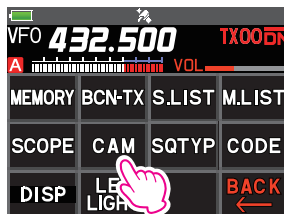
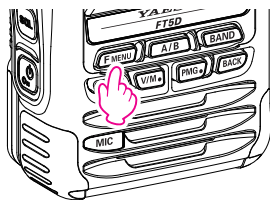

③ Touch the bar graph to switch the frequency

1. Touch the bar graph on the screen.
 - The touched bar graph is displayed in orange and switched to the memory channel frequency and received.
 - Press the PTT switch to transmit as it is, so you can start communicating with the other station immediately.

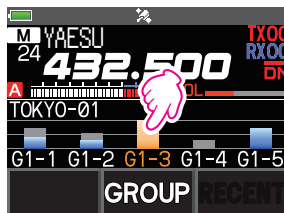

④ Change the displayed CAM group

1. Touch [GROUP] on the CAM screen.
2. Touch the group to select the CAM group (GROUP 01 to 05) to be displayed.

The same operation as above is possible by rotating the DIAL knob to select the CAM group, then press the [BACK] key.

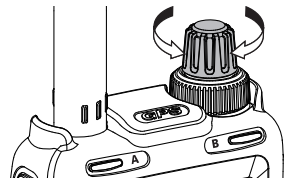

⑤ Delete a registered memory channel from CAM group

1. Touch [**GROUP**] on the CAM screen.

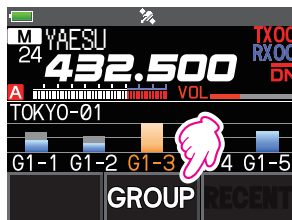

2. Rotate the **DIAL** knob to select the CAM group (GROUP 01 to 10) in which the memory channel to be deleted is registered.

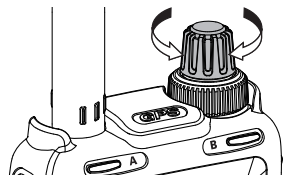

3. Touch [**EDIT**].

- The memory channels registered in the group are displayed in a list.



When the memory channel is displayed as a tag (name), press and hold the [**V/M●**] key to switch to the frequency display. Press and hold the [**V/M●**] key again to switch to the tag (name) display.



4. Rotate the **DIAL** knob to select the registered memory channel to be deleted.

5. Touch [**DEL**].

Confirmation screen "**DELETE?**" is displayed.

6. Touch [**OK**] twice.

- The memory channel is deleted from the CAM group and the list display returns.
- To cancel the deleting, touch [**CANCEL**].

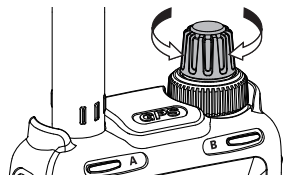

⑥ Delete all the contents in the CAM group at once

1. Touch [**GROUP**] on the CAM screen.

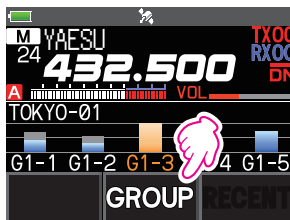

2. Rotate the **DIAL** knob to select the CAM group to be deleted.

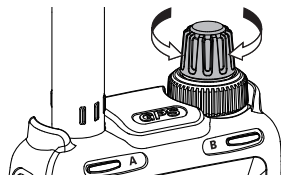

3. Touch [**CLEAR**].

Confirmation screen "**DELETE?**" is displayed.

4. Touch [**OK**] twice.

- All memory channels registered in the selected CAM group will be unregistered.
- The CAM group is deleted and the channel list is displayed again.
- To cancel the deleting, touch [**CANCEL**].



⑦ Changing the name (tag) of CAM group

Change the name of CAM group from the default setting.

1. Touch [**GROUP**] on the CAM screen



2. Rotate the **DIAL** knob to select the desired group to change the tag.

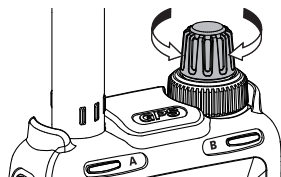

3. Touch **[NAME]**.
4. Enter up to 16 characters for the CAM group tag.
 - Touch [← / →] to move the cursor to left/right in the text input area.
 - Touch [**INS**] to insert a space at the cursor position.
 - Touch [**X**] to erase the character at the cursor position.
 - Touch [**Space**] to enter a space at the cursor position.
5. Press the **[F MENU]** key to return to the previous screen. Press the **[BACK]** key to return to the CAM screen without changing the tag.



⑧ Disable the CAM function

Press the **[BACK]** key or press the **[F MENU]**, and then touch **[CAM]**.

Band Scope

The Spectrum Analyzer presents a view of operating activity on channels above and below the current main band operating frequency as the center.

1. Press the **[F MENU]** key, and then touch **[SCOPE]**.
If **[SCOPE]** is not displayed, touch **[FWD →]** to display **[SCOPE]** and then touch it.
2. With the current frequency in the center, the signal strengths of 39 channels bandwidth are shown on a graph.
3. Touch **[STOP]**.
The band scope scanning stops.
 - To resume band scope scanning, touch **[SEARCH]**.
4. To turn the Band Scope OFF, press the **[BACK]** key.

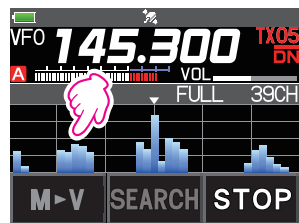
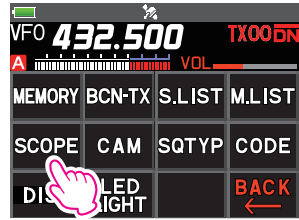

- The band scope channel interval is the same as the VFO frequency step.
- In the frequency range of 108 MHz to 580 MHz, "FULL" is displayed and scanning continues continuously. The received audio can be heard during the scan.
- In frequency ranges other than 108 MHz to 580 MHz, "1Time" is displayed, and scanning is stopped after one scan. Received audio is not heard during scanning. If **[SEARCH]** is touched or the **DIAL** knob is turned to change the frequency, one scan will be performed automatically.



Change frequency

- When a signal on the scope screen is touched, the frequency in the vicinity becomes the receive frequency, and is set to the center frequency of the scope.
- The receive frequency may also be changed by turning the **DIAL** knob.

Change the number of channels displayed

The number of channels to be displayed may be set to 19CH, 39CH or 79CH, by touching the channel display area at the top right of the scope screen.

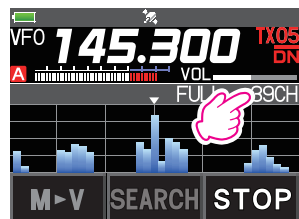

Scanning Function

The FT5DR/DE supports the following four scanning functions:

- VFO Scan
- Memory Channel Scan
- Programmable Memory Scan (PMS)
- Memory Bank Scan



For additional details on the Programmable Memory Scan (PMS) and Memory Bank Scan, refer to the Advanced Manual which may be downloaded from the Yaesu website.

VFO Scan

VFO scan function scans the frequencies, and detects signals.

1. Pres the **[V/M●]** key to enter the VFO mode.
2. Press the **[F MENU]** key, and then touch **[SCAN]**.
If **[SCAN]** is not displayed, touch **[BACK ←]** to display **[SCAN]** and then touch it.
 - When the scan is active, “VFO SCAN” appears on the display.
 - If the scanner halts on an incoming signal, the back light will turn ON and the decimal point between the “MHz” and “kHz” digits of the frequency display will blink. Scanning will resume in about 5 seconds.
 - Change the behavior when the scan is paused with “Setting the Receive Operation When Scanning Stops” on the next page.
3. Press the **PTT** switch or touch **[STOP]** to cancel the scanning.



- If the scan has paused on a signal, rotating the **DIAL** knob will cause scanning to resume instantly.
- If the **DIAL** knob is rotated while scanning is in progress, the scanning will continue up or down in frequency according to the direction of the **DIAL** Knob rotation.

Memory Channel Scanning

The receiver may be set to scan memory channels:

1. Recall a memory channel to begin memory scanning.
 2. Press the **[F MENU]** key, and then touch **[SCAN]**.
If **[SCAN]** is not displayed, touch **[BACK ←]** to display **[SCAN]** and then touch it.
 - When the memory scan is active, “MEM SCAN” appears on the display.
 - If the scanner halts on an incoming signal, the back light will turn ON and the decimal point between the “MHz” and “kHz” digits of the frequency display will blink. Scanning will resume in about 5 seconds.
 - Change the behavior when the scan is paused with “Setting the Receive Operation When Scanning Stops” on the next page.
 3. Press the **PTT** switch or touch **[STOP]** to cancel the scanning.
- If the scan has paused on a signal, rotating the **DIAL** knob will cause scanning to resume instantly.
 - If the **DIAL** knob is rotated while scanning is in progress, the scanning will continue up or down in frequency according to the direction of the **DIAL** Knob rotation.

Setting the Receive Operation When Scanning Stops

1. Press and hold the [**F MENU**] key, and then touch [**SCAN**].
2. Touch [**4 SCAN RESUME**], and then press the [**F MENU**] key.
3. Rotate the **DIAL** knob to select the operation performed after the scan stops:
 - **2.0 sec - 10.0 sec**
The signal is received for a specified period of time, and then scanning resumes. The scan resume time may be set from 2 to 10 seconds at 0.5 second intervals.
 - **BUSY**
The signal is received until the signal fades out. Two seconds after the signal fades out, scanning resumes.
 - **HOLD**
Scanning stops and tuning remains on the current receive frequency (Scanning does not resume).
4. Press the **PTT** switch to save the new setting and exit to normal operation.



The above setting is common for all scanning operation.

Weather Alert Scan

This feature checks the Weather Broadcast Memory Channels for signals that contain the presence of the NOAA Alert Tone while using VFO scan or Memory channel scan. When the Weather Alert Scan feature is engaged, the FT5DR/DE will check the Weather Broadcast Channels for activity every five seconds while scanning. If you watch the display carefully, you can observe the scanner periodically shift to the Weather Broadcast channel and quickly scan the Weather channels in search of the Alert Tone. If no Alert Tone is received, regular scanning will resume for another five seconds.

1. Press and hold the [**F MENU**] key, and then touch [**SIGNALING**].
2. Rotate the **DIAL** knob to select Setup Menu [**14 WX ALERT**].
3. Press the [**F MENU**] key, and then rotate the **DIAL** knob to select "ON".
4. Press the **PTT** switch to save the setting and return to normal operation.
5. Press the [**F MENU**] key, and then touch [**SCAN**].
 - If [**SCAN**] is not displayed, touch [**BACK ←**] to display [**SCAN**] and then touch it.
 - Scanning starts searching upwards in frequency.
 - The display will remain on the VFO frequency, but every five seconds the transceiver will scan the Weather Broadcast Channels for activity.
6. While scanning the Weather channels, press the **PTT** switch and then press the **PTT** switch again.
 - Scanning starts within the Weather Broadcast Channels.
 - While scanning the Weather channels, press the **PTT** switch and then rotate the **DIAL** knob to select the desired Weather Broadcast Channel.
7. Press the **PTT** switch return to normal operation.



For additional details on the Programmable Memory Scan (PMS) and Memory Bank Scan, refer to the Advanced Manual which may be downloaded from the Yaesu website.

Skip Memory Channels, and Specified Memory Channels

Two types of memory channels may be designated, “skip memory channels” and “specified memory channels” for effective memory channel scanning.

Skip memory channels: Permits designating undesired channels to be skipped during scanning. Alternatively, only designated memory channels may be set to be scanned during memory scanning.

Programmable Memory scan (PMS)

This function scans only the range of frequencies between the lower and upper limits registered in a pair of PMS Programmable Memory channels. 50 sets of PMS memory channels (L1/U1 to L50/U50) are available.

Dual Receive (D.RCV) feature

The transceiver checks for signals on the frequency registered to the selected memory channel (Priority Memory Channel) once approximately every 5 seconds.

Convenient Functions

Bluetooth® Operation

The FT5DR/DE has built-in Bluetooth® functionality, so hands-free operation is possible using the optional Bluetooth® headset (SSM-BT20) or a commercially available Bluetooth® headset.



The operation of all commercially available Bluetooth® headsets cannot be guaranteed.

When connecting to a Bluetooth® Headset for the first time -Pairing-

When using the Bluetooth® Headset for the first time, the Bluetooth® Headset and the FT5DR/DE must be paired.

This step is necessary only once at the beginning.

1. To start the Bluetooth® headset in pairing mode.

SSM-BT20: Press and hold the Multi-Function Button, until the SSM-BT20 LED blinks red /blue alternately.

Press and hold the Multi Function Button for 3 seconds to turn ON.

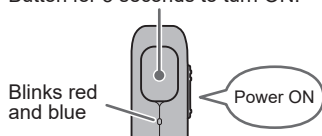

2. Press and hold the [F MENU] key, and then touch [OPTION].

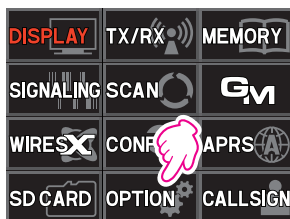

3. Touch [2 Bluetooth].

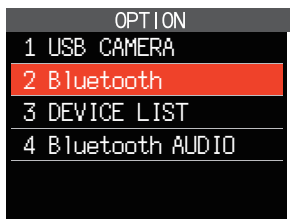

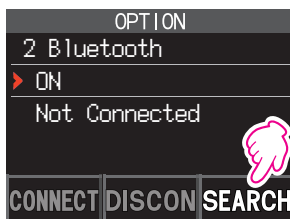

4. Touch [SEARCH].

- “Searching” is displayed and the model name of the found Bluetooth® device is displayed in the list.
- To stop the search in progress, touch [STOP].

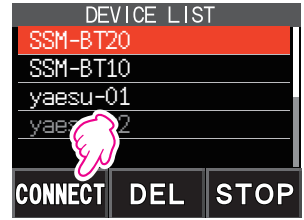

5. Rotate the **DIAL** knob to select the desired Bluetooth® device.
6. Touch [**CONNECT**].



7. When pairing is complete and connected, the Bluetooth® headset model name is displayed.
SSM-BT20: LED blinks blue.
8. Press the **PTT** switch to return to the normal operation.
While connected to a Bluetooth® headset, the “

Disable the Bluetooth function

To cancel Bluetooth® operation, just repeat the above procedures, selecting “OFF” in step 4 above.

Subsequent Bluetooth® headset connection when the power is turned ON

- When the power is turned OFF while the Bluetooth® headset is connected, the next time the power is turned ON, the same Bluetooth® headset is searched for and automatically connected when found.
- If the Bluetooth® headset cannot be found, the “

47

Hands-free operation with a Bluetooth® headset (VOX function)

When FT5DR/DE's VOX (automatic voice transmission) function is turned on, you can use the Bluetooth® headset to perform hands-free operation that transmits automatically just by talking.

Turn on the VOX function according to "VOX Operation" (page 50).



The VOX function settings are the same for the Bluetooth® headset and the microphone of the transceiver. If you do not use the Bluetooth® headset and do not use the VOX function with the transceiver microphone, set it to OFF.

Send by pressing the button on the Bluetooth® headset (when the VOX function is OFF)

When the VOX function is OFF, pressing the "Call button*" on the Bluetooth® headset once will keep the FT5DR/DE in transmit and you can make a call using the Bluetooth® headset.

If you press the "Call button"* again, FT5DR/DE will return to the reception state.

*The button name may differ depending on your Bluetooth® headset.

Press briefly to transmit



SSM-BT20: When the Multi-Function Key is pressed, a beep will sound and the FT5DR/DE will continue to transmit.

Press the Multi-Function Key again, a beep will sound and the FT5DR/DE will be in receive mode.



Press the **PTT** switch on the FT5DR/DE to speak into the microphone of the Bluetooth® headset regardless of whether the VOX function is ON or OFF.

Connect with another Bluetooth® Headset

1. Press and hold the [**F MENU**] key, and then touch [**OPTION**].
2. Touch [**2 Bluetooth**].
3. If already connected to a Bluetooth® headset, touch [**DISCON**] to disconnect.
4. Touch [**SEARCH**].
 - Search Bluetooth® devices to display them in the device list in the following order:
 - (1) Already registered, searched and found Bluetooth® devices: white letters
 - (2) Searched and found new Bluetooth® devices: white letters
 - (3) Already registered but not found by search Bluetooth® devices: gray letters
 - To stop the search in the progress, touch [**STOP**].
5. Rotate the **DIAL** knob to select the desired Bluetooth® device.
6. Touch [**CONNECT**].

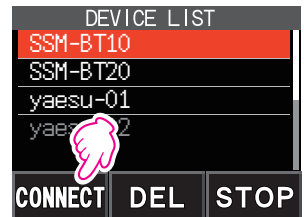
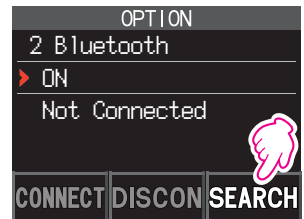
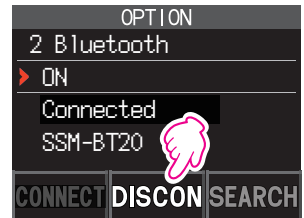
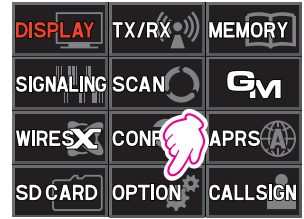

Remove a registered (paired) Bluetooth® device from the list

Select the Bluetooth® device to be deleted in step 6 above, and touch [**DEL**].

Display device list

If [**3 DEVICE LIST**] is touched in step 2 above, Bluetooth® devices that have already been registered are displayed in the device list without performing a search. Connect by turning the **DIAL** knob and selecting the Bluetooth® headset to connect and then touch [**CONNECT**].

VOX Operation

The VOX system provides automatic transmit/receive switching based on voice input to the microphone or Bluetooth® Headset. With the VOX system enabled, you do not need to press the **PTT** switch in order to transmit, and it is not necessary to use a VOX headset in order to utilize VOX operation.

Setting VOX function

1. Press and hold the [**F MENU**] key, and then touch [**TX/RX**].

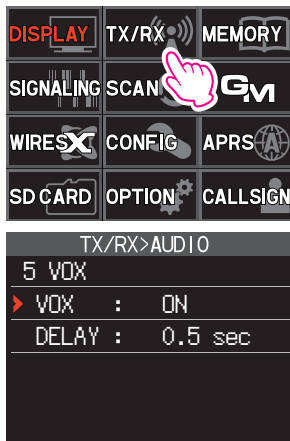

2. Touch [**3 AUDIO**], and then touch [**5 VOX**].
3. Press the [**F MENU**] key, and then rotate the **DIAL** knob to select "**LOW**" or "**HIGH**".

OFF: VOX function OFF

LOW: VOX function ON (VOX Gain Level "**LOW**")

HIGH: VOX function ON (VOX Gain Level "**HIGH**")

Whether set to "**LOW**" or "**HIGH**", the audio from the Bluetooth® headset is automatically transmitted while the Bluetooth® headset is connected. When the Bluetooth® function is OFF, the audio from the FT5DR/DE microphone is automatically transmitted.



- Even if the VOX function is enabled, it will not be in the transmission state while receiving a signal.
- If the VOX function is ON and the Bluetooth® function is OFF, the PTT switch will be disabled.
- Please turn OFF the Bluetooth® function when using the VOX function with the FT5DR/DE microphone.

4. Press the **PTT** switch to return to normal operation.

● Disable the VOX function

To cancel VOX and return to **PTT** operation, just repeat the above procedures, selecting "**OFF**" in step 3 above.

Set the VOX (automatic voice transmission) delay time

During transmission with VOX (automatic voice transmission) function, set the time to stop speaking and return to reception.

1. Press and hold the [**F MENU**] key, and then touch [**TX/RX**].
2. Touch [**3 AUDIO**], and then touch [**5 VOX**].
3. Rotate the **DIAL** knob to select [**DELAY**].

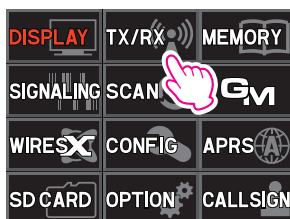

4. Press the **[F MENU]** key, and then rotate the **DIAL** knob to select to select the delay time (the transmit-receive delay after the cessation of speech).
0.5sec / 1.0sec / 1.5sec / 2.0sec / 2.5sec / 3.0sec
Factory default value: "0.5sec".

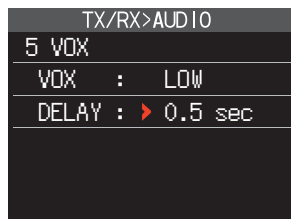

5. Press the **PTT** switch to return to the normal operation.

Convenient Preset Receiver Memory Channels

Weather Broadcast (10 channels), International VHF Marine Radio (57 channels) and Shortwave Broadcasts Stations (89 channels) are recorded in the preset receiver memory channels.

● **Weather Broadcast preset receiver memory channels [WX CH] are listed on:** see below

The frequencies (10 channel) used for the VHF Weather Broadcast Station are registered to dedicated preset receiver memory channels.

● **International VHF Marine Radio preset receiver memory channels [INTVHF] are listed on:** page 53

The frequencies (57 channel) used for the international VHF (marine) radio are registered to dedicated preset receiver memory channels.

● **International World Wide Broadcast preset receiver memory channels [SW] are listed on:** page 54

Listen in to major broadcasts from around the world (89 channels in total).

Preset VHF Weather Broadcast Receiver Memory Channels

The frequencies (10 channels) used for the VHF Weather Broadcast Stations are registered in dedicated preset receiver memory channels.

1. Press the **[A/B]** key to set the A-band as the operating band.
2. Press the **[F MENU]** key, and then touch **[P.RCVR]**.
If **[P.RCVR]** is not displayed, touch **[BACK ←]** to display **[P.RCVR]** and touch it.
3. Press the **[BAND]** key to select **[WX CH]**.
4. Rotate the **DIAL** knob to select the desired channel.
 - For the available Weather Broadcast channels, see the following table.
 - To stop receiving the WX Channel Frequency, press the **[BACK]** key or the **[F MENU]** key, and then touch **[P.RCVR]**.

WX Channel Frequency List

Memory channel No.	Frequency (MHz)	Memory channel No.	Frequency (MHz)
1	162.550	6	162.500
2	162.400	7	162.525
3	162.475	8	161.650
4	162.425	9	161.775
5	162.450	10	163.275

In the event of extreme weather disturbances, such as storms and hurricanes, the NOAA (National Oceanic and Atmospheric Administration) sends a weather alert accompanied by a 1050 Hz tone and subsequent weather report on one of the NOAA weather channels. You may enable the Weather Alert tone via Setup Menu option **[SIGNALING] → [14 WX ALERT]**, if desired (see page 64).

Preset International VHF (Marine) Radio Receiver Memory Channels

The frequencies (57 channels) used for the international VHF Marine Radio are registered in dedicated preset receiver memory channels.

1. Press the **[A/B]** key to set the A-band as the operating band.
 2. Press the **[F NEMU]** key, and then touch **[P.RCVR]**.
If **[P.RCVR]** is not displayed, touch **[BACK ←]** to display **[P.RCVR]** and then touch it.
 3. Press the **[BAND]** key to select **[INTVHF]**.
 4. Rotate the **DIAL** knob to select the desired channel.
 - For the available international VHF channels, see the following table.
 - To stop reception of the international Marine Radio channels, press the **[BACK]** key or press the **[F NEMU]** key, and then touch **[P.RCVR]**.
-
- The preset receiver memory channels cannot be rewritten with another frequency or data.
 - To scan the preset receiver memory channels, press the **[F MENU]** key, and then touch **[SCAN]**.
-
- If the scan has paused on a signal, rotating the **DIAL** knob will cause scanning to resume instantly.
 - If the **DIAL** knob is rotated while scanning is in progress, the scanning will continue up or down in frequency according to the direction of the **DIAL** Knob rotation.
 - To set the transceiver operation when scanning stops, see "Setting the Receive Operation When Scanning Stops" on page 44.
-

International VHF Marine radio frequencies registered in the preset receiver memory channels

Memory channel No.	Frequency (MHz)		Memory channel No.	Frequency (MHz)		Memory channel No.	Frequency (MHz)	
1	156.050	160.650*	20	157.000	161.600*	70	156.525	
2	156.100	160.700*	21	157.050	161.650*	71	156.575	
3	156.150	160.750*	22	157.100	161.700*	72	156.625	
4	156.200	160.800*	23	157.150	161.750*	73	156.675	
5	156.250	160.850*	24	157.200	161.800*	74	156.725	
6	156.300		25	157.250	161.850*	75	156.775	
7	156.350	160.950*	26	157.300	161.900*	76	156.825	
8	156.400		27	157.350	161.950*	77	156.875	
9	156.450		28	157.400	162.000*	78	156.925	161.525*
10	156.500		60	156.025	160.625*	79	156.975	161.575*
11	156.550		61	156.075	160.675*	80	157.025	161.625*
12	156.600		62	156.125	160.725*	81	157.075	161.675*
13	156.650		63	156.175	160.775*	82	157.125	161.725*
14	156.700		64	156.225	160.825*	83	157.175	161.775*
15	156.750		65	156.275	160.875*	84	157.225	161.825*
16	156.800		66	156.325	160.925*	85	157.275	161.875*
17	156.850		67	156.375		86	157.325	161.925*
18	156.900	161.500*	68	156.425		87	157.375	
19	156.950	161.550*	69	156.475		88	157.425	

* Indicates the frequency of the VHF marine base station. For example: if the preset receiver memory channel 1 is selected, the base station frequency 160.650 MHz appears and lights up. Press the **[F MENU]** key, and then touch **[REV]** displays the Ship Station frequency 156.050 MHz appears and blinks. The frequency lower than the base station frequency by 4.6 MHz is the Ship Station frequency and duplex operation may commence. To return to the base station frequency, press the **[F MENU]** key, and then touch **[REV]**.

Preset Worldwide Shortwave Broadcast Receiver Memory Channels

The frequencies (89 channels) used for international worldwide broadcasting are registered to dedicated preset receiver memory channels.

1. Press the **[A/B]** key to set the A-band as the operating band.
2. Press the **[F MENU]** key, and then touch **[P.RCVR]**.
If **[P.RCVR]** is not displayed, touch **[BACK ←]** to display **[P.RCVR]** and then touch it.
3. Press the **[BAND]** key to select **[SW]**.
4. Rotate the **DIAL** knob to select the desired channel.
 - For the available international VHF channels, see the following table.
 - To stop receiving the Worldwide Shortwave Broadcast, press the **[BACK]** key, or press the **[F MENU]** key, and then touch **[P.RCVR]**.
 - Depending on time zone or signal strength, broadcasts may not be received.
 - There are broadcast stations other than those listed below that can also be received. In addition, the broadcast station frequency may be changed, it may be off air or have become discontinued. For current details, please refer to a commercial-available frequency list.

Worldwide Shortwave Broadcasts

CH Number	Frequency (MHz)	Name	Broadcast Station Name	CH Number	Frequency (MHz)	Name	Broadcast Station Name
1	6.030	VOA	USA	29	9.660	VATICAN	Vatican
2	6.160	VOA	USA	30	11.625	VATICAN	Vatican
3	9.760	VOA	USA	31	11.830	VATICAN	Vatican
4	11.965	VOA	USA	32	15.235	VATICAN	Vatican
5	9.555	CANADA	Canada	33	5.955	NEDERLAND	Netherlands
6	9.660	CANADA	Canada	34	6.020	NEDERLAND	Netherlands
7	11.715	CANADA	Canada	35	9.895	NEDERLAND	Netherlands
8	11.955	CANADA	Canada	36	11.655	NEDERLAND	Netherlands
9	6.195	BBC	UK	37	5.985	CZECH LIBERTY	Czech Republic
10	9.410	BBC	UK	38	6.105	CZECH LIBERTY	Czech Republic
11	12.095	BBC	UK	39	9.455	CZECH PRAGUE	Czech Republic
12	15.310	BBC	UK	40	11.860	CZECH LIBERTY	Czech Republic
13	6.090	FRANCE	France	41	9.780	PORTUGAL	Portugal
14	9.790	FRANCE	France	42	11.630	PORTUGAL	Portugal
15	11.670	FRANCE	France	43	15.550	PORTUGAL	Portugal
16	15.195	FRANCE	France	44	21.655	PORTUGAL	Portugal
17	6.000	DEUTSCHE WELLE	Germany	45	9.650	SPAIN	Spain
18	6.075	DEUTSCHE WELLE	Germany	46	11.880	SPAIN	Spain
19	9.650	DEUTSCHE WELLE	Germany	47	11.910	SPAIN	Spain
20	9.735	DEUTSCHE WELLE	Germany	48	15.290	SPAIN	Spain
21	5.990	ITALY	Italy	49	6.055	NIKKEI	Japan (Nikkei)
22	9.575	ITALY	Italy	50	7.315	NORWAY	Norway
23	9.675	ITALY	Italy	51	9.590	NORWAY	Norway
24	17.780	ITALY	Italy	52	9.925	NORWAY	Norway
25	7.170	TURKEY	Turkey	53	9.985	NORWAY	Norway
26	7.270	TURKEY	Turkey	54	6.065	SWEDEN	Sweden
27	9.560	TURKEY	Turkey	55	9.490	SWEDEN	Sweden
28	11.690	TURKEY	Turkey	56	15.240	SWEDEN	Sweden

CH Number	Frequency (MHz)	Name	Broadcast Station Name
57	17.505	SWEDEN	Sweden
58	6.120	FINLAND	Finland
59	9.560	FINLAND	Finland
60	11.755	FINLAND	Finland
61	15.400	FINLAND	Finland
62	5.920	RUSSIA	Russia
63	5.940	RUSSIA	Russia
64	7.200	RUSSIA	Russia
65	12.030	RUSSIA	Russia
66	7.465	ISRAEL	Israel
67	11.585	ISRAEL	Israel
68	15.615	ISRAEL	Israel
69	17.535	ISRAEL	Israel
70	6.045	INDIA	India
71	9.595	INDIA	India
72	11.620	INDIA	India
73	15.020	INDIA	India
74	7.190	CHINA	China
75	7.405	CHINA	China
76	9.785	CHINA	China
77	11.685	CHINA	China
78	6.135	KOREA	South Korea
79	7.275	KOREA	South Korea
80	9.570	KOREA	South Korea
81	13.670	KOREA	South Korea
82	6.165	JAPAN	Japan
83	7.200	JAPAN	Japan
84	9.750	JAPAN	Japan
85	11.860	JAPAN	Japan
86	5.995	AUSTRALIA	Australia
87	9.580	AUSTRALIA	Australia
88	9.660	AUSTRALIA	Australia
89	12.080	AUSTRALIA	Australia

Receive Mode: AM

Using the Voice Recording

With the voice recording function, the received audio of the other station, and/or the transmit audio of the FT5DR/DE is recorded on the microSD memory card. The recorded file can be played back with FT5DR/DE or the microSD memory card can be taken out and used on a PC.

Once recording is started, recording continues until recording is stopped, or the capacity of the microSD card is full.

About the file

- The audio file is saved in the “VOICE” folder on the microSD card.
 - The file format is a Wave sound format file (extension: wav).
 - The file name is “YYMMDDmmhhss.wav” (YY: year, MM: month, DD: day, hh: hour, mm: minute, ss: second) depending on the date and time when the recording started.
- When using the microSD memory card for the first time, please refer to “Formatting a microSD Memory Card” on page 19 for formatting.
- Since the date and time information is used for file names and file timestamps, when using the voice recording function, it is recommended to set the date and time of the transceiver in advance by referring to “19 DATE & TIME ADJ” on page 65 It is recommended.

Recording the receive audio

1. Press the **[F MENU]** key, and then touch **[REC]**.
If **[REC]** is not displayed, touch **[BACK ←]** to display **[REC]** and then touch it.
 - The display will indicate “RECSTART” and recording will begin.
 - During recording, “●” icon is displayed at the top of the screen.
 - With the factory default settings, the “A-band” received audio is recorded.
 - Recording will be paused about 3 seconds after the squelch of the band that is recording is closed. Recording will resume when a signal is received.
 - The band or bands to be recorded, and whether or not to include the transmit audio in the recording may be selected in the Setup Menu.

Recording is stopped when the transceiver is turned OFF.

2. Press the **[F MENU]** key, and then touch **[REC STOP]**.
The recording will be stop.

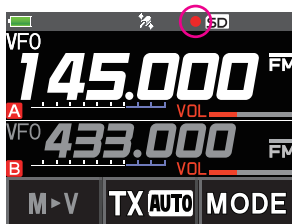
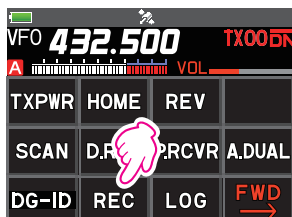

Setting the Recording function

The band or bands to be recorded, and whether or not to include the transmit audio in the recording may be selected:

1. Press and hold the [**F MENU**] key, and then touch [**TX/RX**].
2. Touch [**3 AUDIO**], and then touch [**6 RECORDING**].
3. Press the [**F MENU**] key, and then rotate the **DIAL** knob to select the band to record.
A: Record the A-band received audio
B: Record the B-band received audio
A+B: Record both A-band and B-band received audio
4. Press the [**BACK**] key, and then rotate the **DIAL** knob to select "**MIC**".
5. Press the [**F MENU**] key, and then rotate the **DIAL** knob to select "ON" or "OFF".
ON: Record both transmit and receive audio
OFF: Record only the receive audio
6. Press the **PTT** switch to return to the normal operation.

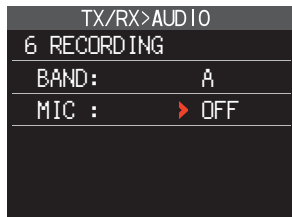
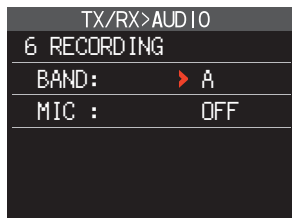
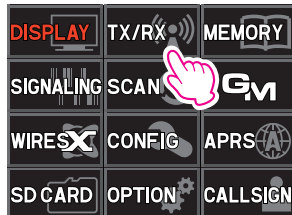

Playback the recorded audio

1. Press the [**F MENU**] key, and then touch [**LOG**].
If [**LOG**] is not displayed, touch [**BACK ←**] to display [**LOG**] and then touch it.
2. Touch [**VOICE**].
 - The recorded file will be displayed in a list.
 - Touch [**▲/▼**] to display 20 files at a time.
 - Touch [**TOP**] to display the latest file.
3. Touch the file to playback.
 - Playback will begin (The receiver audio will not be heard during playback).
 - Play back while recording is not possible.
 - Touch the bar graph to play from that point.
 - Touch [**||**] to pause playback.
 - Touch [**◀◀/▶▶**] to rewind or fast forward 5 seconds at a time.

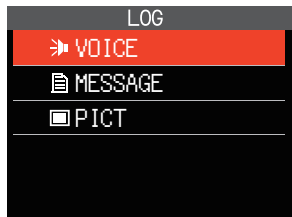

● Delete files

1. Rotate the **DIAL** knob in step 2 to select the file to be deleted, and then touch [**DEL**].
Confirmation screen "**DELETE?**" is displayed.
2. Touch [**OK**].

Taking Pictures (Snapshot Function)

Pictures can be taken by connecting the optional camera-equipped speaker microphone (MH-85A11U).

Captured image data can be saved onto a microSD memory card inserted in the transceiver.

The saved data can be displayed on the screen and transmitted to other transceivers* as well.

In addition, the most recently captured image data can be transmitted to other transceivers* by pressing (Send Image Button) on the camera-mounted speaker microphone.

* Refer to the Yaesu website or catalog for the compatible transceiver models.

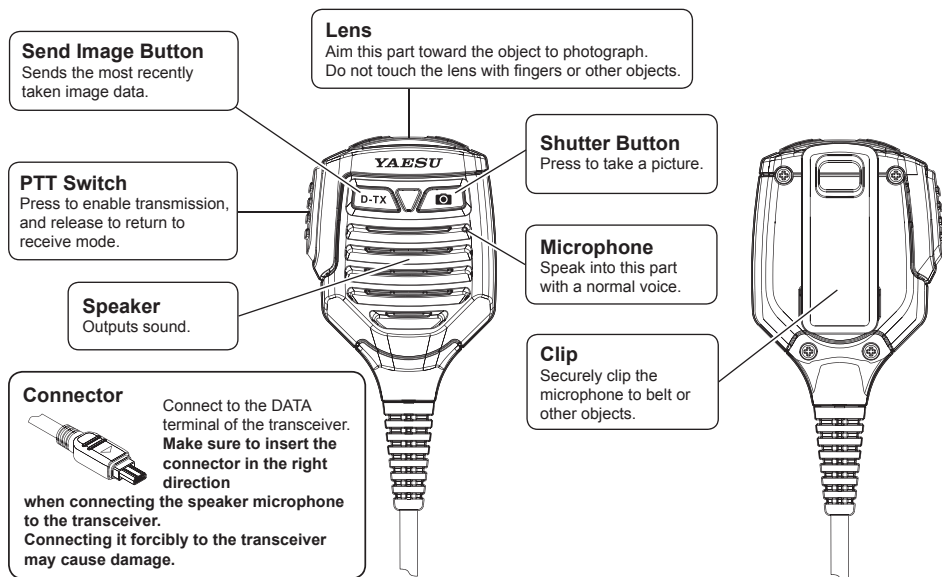

- Make sure to keep at least 50 cm distance between the lens and the object. If the object is too close, the picture will be out of focus, resulting in a blurred picture.
- You can set the size (resolution) and image quality (compression ratio) of the image to be shot by the following operations.

Press and hold the [F MENU] key → [OPTION] → [1 USB CAMERA].

- If your station and the remote station are both in digital mode, you can transfer the image data most recently taken by pressing [D-TX] key on the MH-85A11U.
- Set the digital mode in advance to transfer images to other radios.
- Do not directly photograph objects with strong light, such as the sun or other bright objects. Doing so can cause malfunction.
- If the lens or the microphone gets dirty, use a dry, soft cloth to wipe off the contaminants.

Taking pictures

1. Connect the camera-equipped speaker microphone (MH-85A11U) to the DATA terminal of the FT5DR/DE.



- When connecting or disconnecting the MH-85A11U, turn off the FT5DR/DE.
 - When receiving an AM radio broadcast signal with the camera microphone connected, noise may occur, but this is not a malfunction.
-

2. Point the camera lens at the object to be photographed and press the shutter button  on the microphone.
 - The captured image appears on the LCD.
 - Touch the image, to temporarily turn OFF the display of buttons and view the entire photo. Touch the image again to display the buttons.
3. To save the image onto the microSD memory card, touch **[SAVE]**. Press the **[BACK]** key or touch **[DEL]** to return the display to the previous operating screen without saving the image.
4. To transmit the saved image to other transceivers, press the **[D-TX]** key on the MH-85A11U or touch **[SEND]**.
5. Press the **[BACK]** key or touch **[OK]** to return to the normal operation.

Viewing the Saved Image

1. Press the **[F MENU]** key, and then touch **[LOG]**.
If **[LOG]** is not displayed, touch **[BACK ←]** to display **[LOG]** and then touch it.
2. Touch **[PICT]**.
Displays the saved image data list.
3. Touch the image to be displayed.
 - Displays the selected image.
 - To transmit the image to other transceivers, touch **[SEND]** or **[FWD]**. When the transfer is complete, the screen in step 3 will return.
4. Press the **[BACK]** key several times to return to the previous operating screen.

GPS Function

FT5DR/DE is equipped with GPS (Global Positioning System) reception function. When receiving signals from GPS satellites, the current position (latitude, longitude, altitude) can be calculated and displayed within the tolerance of several meters. In addition, GPS can receive the exact time from a satellite-mounted atomic clock.



- When the GPS function is active, the power consumption increases by about 15 mA.
 - To turn the GPS function ON/OFF:
Press and hold the **[F MENU]** key → **[APRS]** → **[20 GPS POWER]**
-

WIRES-X function

WIRES (Wide-coverage Internet Repeater Enhancement System) is an Internet communication system which expands the range of amateur radio communication.

By connecting with a local WIRES-X Node station, the FT5DR/DE can communicate and exchange data via the internet with WIRES-X nodes worldwide.

Use the News Station function to write (upload) and read (download) digital data (text, images and audio).

When connected to a WIRES-X node station or room, the node name, room name, call sign of the other station, distance, and direction, are all displayed on this screen.

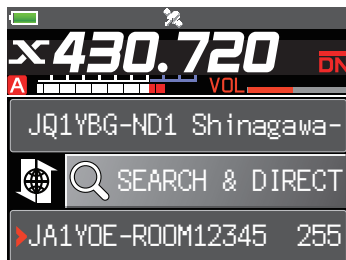

Example of display when connected to a room



For details, refer to the separate WIRES-X Instruction Manual which is available on the Yaesu website.

APRS (Automatic Packet Reporting System) function

The FT5DR/DE uses a GPS receiver to acquire and display its position location information.

The APRS feature uses the location information to transmit the position information, data and messages, using the format developed by Bob Bruninga WB4APR.

Upon receiving an APRS report from a remote station, the direction and distance to the remote station from your station, the speed of the remote station, and other data sent by the remote station may be displayed on the LCD of your transceiver.



Example of display when an APRS signal is received

Setting several station parameters, such as the call sign and symbol is required before using the APRS function (initial settings).



For details, refer to the APRS Function Instruction Manual which is available on the Yaesu website.



For additional details on the following Functions, refer to the Advanced Manual which may be downloaded from the Yaesu website.

Tone squelch feature

The tone squelch opens the speaker audio only when a signal containing the specified CTCSS tone is received. By matching the tone frequency with the partner station in advance, a quiet standby is possible.

Digital Code squelch (DCS) feature

DCS (Digital Coded Squelch) function that allows audio to be heard only when signals containing the same DCS code are received.

New PAGER (EPCS) feature

This new feature allows calling specified stations only, by using a pager code that combines two CTCSS tones. Even when the person who is called is not near the transceiver, the information is displayed on the LCD to indicate that a call was received. When the call is received, the bell sounds.

Digital Personal ID (DP-ID) feature

Digital Personal ID (DP-ID) feature opens the speaker audio only when a signal set to the same DP-ID in the Digital Mode is received.

Using Setup Menu

The Setup Menu permits configuring the various functions according to individual operating needs and preferences.

Setup Menu Operation

1. Press and hold the [**F MENU**] key.
The Setup Menu screen will be displayed.

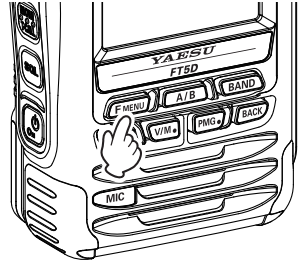

2. Touch the desired item in Setup Menu.
The Sub-menu screen will be displayed.
 - You can also turn the **DIAL** knob to indicate a menu item, and then press the [**F MENU**] key to select it.

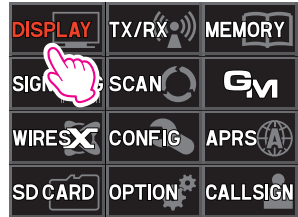

3. Touch the desired Setup Menu Sub-menu.
 - Turn the **DIAL** knob to display a sub-menu that is not displayed, then touch it.
 - You can also turn the **DIAL** knob to indicate a menu item, and then press the [**F MENU**] key to select it.

[When there is no deeper level of menu items]
Go step 4.

[When there is deeper level of menu items]

 - Touch the desired item.
 - Turn the **DIAL** knob to indicate a desired item, and then press the [**F MENU**] key to select it.
4. Rotate the **DIAL** knob to select the desired item to set.
5. Press the **PTT** switch to save the settings and return to normal operation.
On some setting screens, pressing **PTT** switch does not exit from Menu Mode. In this case, press the [**BACK**] key, then press the **PTT** switch to return to the frequency display screen.

Tables of Setup Menu Operations

Setup Menu no. / Item	Description	Selectable options (Options in bold are the default settings)
DISPLAY		
1 TARGET LOCATION	Set what to display using the smart navigation function.	COMPASS / NUMERIC
2 COMPASS	Set the compass display of the smart navigation function.	HEADING UP / NORTH UP
3 BAND SCOPE	Set the number of search channels for the band scope function.	19ch / 39ch / 79ch
4 LAMP	Set the duration time of the back light and keys to be lit.	KEY: OFF / 2 sec to 180 sec / CONTINUOUS KEY: 30 sec SAVE: ON / OFF
5 LANGUAGE	Switch between Japanese/English for the menus and Setup Menu, etc.	ENGLISH / JAPANESE
6 LCD BRIGHTNESS	Set the brightness level of the LCD back light and numeric keypad light.	LEVEL1 to LEVEL6
7 DISPLAY COLOR	Set the font color of the operation band frequency.	WHITE / BLUE / RED
8 OPENING MESSAGE	Set the opening message type.	OFF / DC / MESSAGE
9 SENSOR INFO	Display the voltage.	VOLT
10 SOFTWARE VERSION	Display the software version.	Main / Sub / DSP
TX/RX		
1 MODE		
1 ANTENNA ATT	Switch the attenuator between ON/OFF.	ON / OFF
2 FM DEVIATION	Set the FM transmission modulation level.	WIDE / NARROW
3 RX MODE	Select the receive mode.	AUTO / FM / AM
2 DIGITAL		
1 DIGITAL POPUP	Set the POP UP time.	OFF / BAND2s / BAND4s / BAND6s / BAND8s / BAND10s / BAND20s / BAND30s / BAND60s / BNDCNT
2 LOCATION SERVICE	Set whether or not to display your current location in digital mode.	ON / OFF
3 STANDBY BEEP	Switch the standby beep function between ON/OFF.	ON / OFF
4 DIGITAL VW	Turn the VW mode selection ON or OFF.	OFF / ON
5 AUDIO PITCH	Audio quality setting of received audio in digital mode.	FLAT / HIGH BOOST / LOW BOOST
3 AUDIO		
1 MIC GAIN	Adjust the microphone gain level.	LEVEL1 to LEVEL9 LEVEL5
2 MUTE	Set the muting level on the non operating band side when a signal is received on the operating band side.	OFF / MUTE 30% / MUTE 50% / MUTE 100%
3 RX AF DUAL	Set the resumption time of radio reception in the AF Dual mode.	Transmit and receive 1 second to 10 seconds, Fixed, or transmission 1 second to 10 seconds. Transmit and receive 2 seconds
4 SP SELECT	Speaker operation switching settings when connecting to an external SP/ MIC	AUTO / FIX
5 VOX	VOX function setting.	VOX: OFF / LOW / HIGH DELAY: 0.5s / 1.0s / 1.5s / 2.0s / 2.5s / 3.0s
6 RECORDING	Voice recode function setting.	BAND: A / B / A+B MIC: ON / OFF

Setup Menu no. / Item	Description	Selectable options (Options in bold are the default settings)
MEMORY		
1 BANK LINK	Set the memory bank link.	BANK1 to BANK24 BANK LINK ON / OFF
2 BANK NAME	Assign a name to each memory bank.	BANK1 to BANK24
3 MEMORY NAME	Input the memory channel tag.	Up to 16 letters
4 MEMORY PROTECT	Set whether to allow or prohibit memory channel registration.	ON / OFF
5 MEMORY SKIP	Set for skip memory / specify memory.	OFF / SKIP / SELECT
6 MEMORY WRITE	Set the automatic channel number increment when registering to a memory channel.	NEXT / LOWER
SIGNALING		
1 BELL	Set the bell function settings.	SELECT: OFF / BELL RINGER: 1Time to 20Time / CONTI
2 DCS CODE	Set the DCS code.	DCS 023 to DCS 754
3 DCS INVERSION	Select a combination of DCS inversion codes in terms of communication direction.	RX (Receive): NORMAL (Homeomorphic) / INVERT (Inversion) / BOTH (Both Phase) TX (Transmission): NORMAL (Homeomorphic) / INVERT (Inversion)
4 DTMF MODE	Set the transmission of DTMF code registered to a DTMF memory channel, DTMF code transmission delay time, and DTMF code transmission speed.	MODE: MANUAL / AUTO DELAY: 50ms / 250ms / 450ms / 750ms / 1000ms SPEED: 50ms / 100ms
5 DTMF MEMORY	Set the DTMF auto dialer channel and code (16 characters).	CH1 to CH10
6 PAGER	Turn the pager answerback Function ON/OFF, and specify a personal code (transmit/receive).	ANS-BACK: ON / OFF CODE-RX: 01 to 50 for each, 05 47 CODE-TX: 01 to 50 for each, 05 47
7 PR FREQUENCY	Set a non-communication squelch.	300Hz to 3000Hz 1600Hz
8 SQL LEVEL	Select a squelch level.	LEVEL0 to LEVEL15 LEVEL1
9 SQL S-METER	Select an S-Meter squelch level.	OFF / LEVEL1 to LEVEL10
10 SQL EXPATIATION	Set a squelch type separately for Receive and transmit.	ON / OFF
11 SQL TYPE	Select a squelch type.	OFF / TONE / TONE SQL / DCS / REV TONE / PR FREQ / PAGER / (D CD) / (TONE-DCS) / (D CD-TONE SQL) * The options in the parentheses are available when the SQL expansion is ON.
12 TONE SQL FREQ	Set a tone frequency.	67.0Hz to 254.1Hz 100.0Hz
13 TONE SEARCH	Set the audio output during tone search. Turn the muting function on/off and select a tone search speed.	MUTE: ON / OFF SPEED: FAST / SLOW
14 WX ALERT	Enables/Disables the Weather Alert Feature.	ON / OFF
SCAN		
1 DW TIME	Set the priority memory channel monitoring interval.	0.1sec to 10sec 5.0sec
2 SCAN LAMP	Set whether or not to light up the scan lamp when scanning stops.	ON / OFF
3 SCAN RE-START	Set the scanning restart time.	0.1sec to 10sec 2.0sec
4 SCAN RESUME	Configure the scan stop mode settings.	SCAN: BUSY / HOLD / 2.0sec to 10sec 5.0sec DW: BUSY / HOLD / 2.0sec to 10.0sec
5 SCAN WIDTH	Set the scan mode operation.	VFO: ALL / BAND MEMORY: ALL CH / BAND BANK LINK: ON / OFF

Setup Menu no. / Item	Description	Selectable options (Options in bold are the default settings)
6 PRIORITY REVERT	Turn the "Priority Channel Revert" feature ON or OFF during Dual Receive.	ON / OFF
GM		
* For details of the functions, refer to the GM Function Instruction Manual.		
1 DP-ID LIST	Displays the DP-ID list screen.	-
2 RADIO ID CHECK	Display the transceiver specific number (ID). (Uneditable)	-
WIRES-X		
* For details of the functions, refer to the WIRES-X Instruction Manual.		
1 RPT/WIRES FREQ	Set the frequency to be used for Repeater/WIRES.	MANUAL / PRESET
2 SEARCH SETUP	Set the WIRES ROOM selection method.	HISTORY / ACTIVITY
3 EDIT CATEGORY TAG	Edit category tags.	C1 to C5
4 REMOVE ROOM/NODE	Delete registered Category ROOMs.	C1 to C5
5 DG-ID	Set the DG-ID number for WIRES-X.	01 to 99 / AUTO
CONFIG		
1 APO	Set the length of time until the transceiver turns off automatically.	OFF / 0.5HOUR to 12HOUR
2 BCLO	Turn on/off the busy channel lockout function.	ON / OFF
3 BEEP	Set the beep emitting function, and set whether or not to emit the beep sound when a band edge/CH1 is encountered.	SELECT: KEY&SCAN / KEY / OFF EDGE: ON / OFF
4 BEEP LEVEL	Beep volume setting.	LOW / HIGH
5 BUSY LED	Turn on/off the BUSY indicator.	A BAND: ON / OFF B BAND: ON / OFF RADIO: ON / OFF
6 CLOCK TYPE	Set the clock shift function.	A / B
7 GPS LOG	Set the GPS log recording time interval.	OFF / 1sec / 2sec / 5sec / 10sec / 30sec / 60sec
8 HOME VFO	Enable/disable VFO transmission in Home Channel.	ENABLE / DISABLE
9 LOCK	Configure the lock mode setting.	KEY&DIAL / PTT / KEY&PTT / DIAL&PTT / ALL / KEY / DIAL
10 MONI/T-CALL	Select the function of the MONI/T-CALL switch.	MONI / T-CALL (Depends on the transceiver version)
11 TIMER	Switch the timer between ON and OFF.	POWER ON: 00:00 ~ 23:59 POWER OFF: 00:00 ~ 23:59
12 PASSWORD	Input the password.	OFF / ON : - - -
13 PTT DELAY	Set the PTT delay time.	OFF / 20ms / 50ms / 100ms / 200ms
14 RPT ARS	Turn the ARS function on/off.	ON / OFF
15 RPT SHIFT	Set the repeater shift direction.	SIMPLEX / -RPT / +RPT
16 RPT SHIFT FREQ	Set the repeater shift width.	0.000MHz to 150.000MHz
17 SAVE RX	Set the receive save time.	OFF / 0.05sec (1:1) to 20.0sec (1:400)
18 STEP	Set the channel step.	AUTO / 5.0 kHz / 6.25 kHz / (8.33 kHz) / (9.0 kHz) / 10.0 kHz / 12.5 kHz / 15.0 kHz / 20.0 kHz / 25.0 kHz / 50.0 kHz / 100.0 kHz
19 DATE & TIME ADJ	Set the built-in clock.	-
20 TOT	Set the timeout timer.	OFF / 30 sec to 10 min 00 sec 3 min 00 sec
21 VFO MODE	Select the frequency selection range in the VFO mode.	ALL / BAND

Setup Menu no. / Item	Description	Selectable options (Options in bold are the default settings)
22 BAND SELECT	Set the frequency bands that can be selected for A-band and B-band ("OTHER" includes 50MHz band*, VHF (1), VHF (2), UHF (1), UHF (2)*) * A band only	AIR: ON / OFF VHF: ON / OFF UHF: ON / OFF OTHER: ON / OFF SW*: ON / OFF AM*: ON / OFF FM*: ON / OFF *A-band only.
23 DIAL KNOB CHANGE	Select a vibrator mode and set up the vibrator function.	-
APRS		
* For details of the functions, refer to the APRS Instruction Manual.		
1 APRS AF DUAL	Turn ON/OFF the muting function when both the APRS function and AF dual function are active.	ON / OFF
2 APRS DESTINATION	Display the model code.	APY05D (Uneditable)
3 APRS FILTER	Select the filter function.	Mic-E: ON / OFF POSITION: ON / OFF WEATHER: ON / OFF OBJECT: ON / OFF ITEM: ON / OFF STATUS: ON / OFF OTHER: ON / OFF ALTNET: ON / OFF
4 APRS MODEM	Set the APRS baud rate.	OFF / 1200bps / 9600bps
5 APRS MSG FLASH	Set the strobe to flash when there is an incoming message.	MSG: OFF / 2sec to 60sec / CONTINUOUS / EVERY 2s to EVERY 10m 4sec GRP: OFF / 2sec to 60sec / CONTINUOUS 4sec BLN: OFF / 2sec to 60sec / CONTINUOUS 4sec
6 APRS MSG GROUP	Group filtering for received messages.	G1: ALLxxxxxx G2: CQxxxxxxx G3: QSTxxxxxx G4: YAESUxxxx G5: ----- B1: BLNxxxxxx B2: BLNx B3: BLNx
7 APRS MSG TEXT	Input the fixed text message.	1 to 8
8 APRS MUTE	Set the B-band AF muting function on/off when APRS is active.	ON / OFF
9 APRS POPUP	Set the beacon type, message type and time for pop-up display.	The setting values of Mic-E, POSITION, WEATHER, OBJECT, ITEM, STATUS, OTHER, MY PACKET, MSG, GRP and BLN are as follows. OFF / ALL2s to ALL60s / ALLCNT / BND2s to BND60s / BNDCNT ALL10s The setting values of MY MSG, DUP.BCN, DUP.MSG, ACK.REJ and OTHER MSG are as follows.: OFF / BND2s to BND60s BND10s

Setup Menu no. / Item	Description	Selectable options (Options in bold are the default settings)
10 APRS RINGER	Set the bell ring on/off when a beacon or message is received.	Mic-E: ON / OFF POSITION: ON / OFF WEATHER: ON / OFF OBJECT: ON / OFF ITEM: ON / OFF STATUS: ON / OFF OTHER: ON / OFF MY PACKET: ON / OFF MSG: ON / OFF GRP: ON / OFF BLN: ON / OFF MY MSG: ON / OFF DUP.BCN: ON / OFF DUP.MSG: ON / OFF ACK.REJ: ON / OFF OTHER MSG: ON / OFF TX BCN: ON / OFF TX MSG: ON / OFF
11 APRS UNIT	Select the units for APRS display.	POSITION: MM.MM' / MM'SS" DISTANCE: km / mile SPEED: km/h / knot / mph ALTITUDE: m / ft TEMP: °C / °F RAIN: mm / inch WIND: m/s / mph (Depends on the transceiver version)
12 APRS TX DELAY	Set the data sending delay time.	100ms to 1000ms 300ms
13 BEACON INFO	Set the transmission beacon information.	AMBIGUITY: OFF / 1dig / 2dig / 3dig / 4dig SPD/CSE: ON / OFF ALTITUDE: ON / OFF
14 BEACON INTERVAL	Set a beacon automatic sending interval.	30sec / 1min / 2min / 3min / 5min / 10min / 15min / 20min / 30min / 60min
15 BEACON STATUS TEXT	Input setting for status text.	S.TXT: ON / OFF TX RATE: 1/1 to 1/8 TEXT: Text1 to Text5
16 BEACON TX	Select automatic or manual sending of beacon.	AUTO / MANUAL / (SMART)
17 COM PORT SETTING	Set the COM port.	STATUS: ON / OFF SPEED: 4800 / 9600 / 19200 / 38400 INPUT: OFF / GPS OUTPUT: OFF / GPS / WAY.P WAYPOINT: NMEA9 / NMEA6 / NMEA7 / NMEA8 Mic-E: ON / OFF POSIT: ON / OFF WEATHER: ON / OFF OBJECT: ON / OFF ITEM: ON / OFF
18 DIGI PATH	Set the digital repeater route.	P1 OFF P2(1) 1 WIDE1 - 1 P3(2) 1 WIDE1 - 1 / 2 WIDE2 - 1 P4(2) 1..... / 2..... P5(2) 1..... / 2..... P6(2) 1..... / 2..... P7(2) 1..... / 2..... P8(8) 1..... to 8.....
19 GPS SETUP	Select a datum used for the GPS function.	DATUM: WGS-84 / Tokyo (Mean) PINNING: ON / OFF DGPS: ON / OFF
20 GPS POWER	Turn the GPS function ON/OFF.	GPS ON / GPS OFF

Setup Menu no. / Item	Description	Selectable options (Options in bold are the default settings)
21 GPS TIME SET	Turn on/off the GPS time and date automatic acquisition function.	AUTO / MANUAL
22 GPS UNIT	Select the units for GPS display.	POSITION: .MMM' / 'SS" SPEED: km/h / knot / mph ALTITUDE: m / ft (Depends on the transceiver version)
23 CALLSIGN (APRS)	Specify the call sign of your station.	- - - - -
24 MY POSITION	Set your location.	GPS / Manual / P1 to P10
25 MY SYMBOL	Set your station symbol.	48 icons including 1 (/[Human/Person]) / 2(/b Bicycle) / 3(/> Car) / 4(YY Yaesu Radios)
26 POSITION COMMENT	Set up the position comment function.	Off Duty / En Route / In Service / Returning / Committed / Special / Priority / Custom 0 to 6 / EMERGENCY!
27 SmartBeaconing	Set the smart beaconing function.	STATUS: OFF / TYPE1 / TYPE2 / TYPE3 * For details on the following setting items for each type, refer to the APRS Instruction Manual. LOW SPD, HIGH SPD, SLOW RATE, FAST RATE, TURN ANGL, TURN SLOP, TURN TIME
28 TIME ZONE	Set the time zone.	UTC -13:00 to UTC 0:00 to UTC +13:00 UTC 0:00
SD CARD		
1 BACKUP	Save the data stored on the transceiver onto a microSD memory card or load the data from a microSD card.	Write to SD / Read from SD
2 MEMORY CH	Save or load the memory channel information onto or from a microSD memory card.	Write to SD / Read from SD
3 MEMORY INFO	Displays the total capacity and free space of the SD Memory Card.	-
4 FORMAT	Initialize microSD memory cards.	-
OPTION		
1 USB CAMERA	Set the USB camera resolution and Speaker.	SIZE: 320x240 / 160x120 QUALITY: LOW / NORMAL / HIGH SP SEL: CAMERA / INT SP
2 Bluetooth	Sets the Bluetooth function.	OFF / ON CONNECT/DISCON
3 DEVICE LIST	Bluetooth device list.	-
4 Bluetooth Audio	Set whether received audio is heard from both the Bluetooth® headset and the transceiver speaker, or only from the connected Bluetooth® device.	AUTO / FIX
CALLSIGN		
CALLSIGN	Set the call sign.	xxxxxxxxxx

Restoring to Defaults (Reset)

Caution

When the All Reset function is performed, all data registered in the memory will be deleted. Be sure to note the settings on paper or back up the data on a microSD memory card.

All Reset

To restore all transceiver settings and memory content to the factory defaults.

1. Turn the transceiver **OFF**.
2. Press and hold the [**F MENU**] key, the [**A/B**] key and the [**BAND**] key and turn the transceiver **ON** simultaneously.

The beep sounds and the confirmation screen is displayed.

3. Touch [**OK**].
 - The beep will sound, and the transceiver will reset all factory defaults.
 - After resetting all defaults, the call sign input message appears on the LCD. Set the call sign.
 - To cancel the resetting, touch [**CANCEL**].

Setup Menu Reset

All the Setup Menu only, settings can be restored to the default settings.

1. Turn the transceiver **OFF**.
2. Press and hold the [**F MENU**] key and the [**A/B**] key and turn the transceiver **ON** simultaneously.

The beep sounds and the confirmation screen is displayed.

3. Touch [**OK**].
 - The beep will sound, and the transceiver will reset all Setup Menu settings are reset to defaults.
 - To cancel the resetting, touch [**CANCEL**].
 - To reset all the following items, perform All Reset (see above).

[DISPLAY]

8 OPENING MESSAGE

[SIGNALING]

1 BELL

2 DCS CODE

3 DCS INVERSION

5 DTMF MEMORY

6 PAGER

7 PR FREQUENCY

9 SQL S-METER

11 SQL TYPE

12 TONE SQL FREQ

[WIRES-X]

1 RPT/WIRES FREQ

2 SEARCH SETUP

3 EDIT CATEGORY TAG

[CALLSIGN]

CALLSIGN

[TX/RX]

1-1 ANTENNA ATT

1-2 FM DEVIATION

1-3 RX MODE

2-4 DIGITAL VW

[SCAN]

5 SCAN WIDTH

[CONFIG]

6 CLOCK TYPE

12 PASSWORD

15 RPT SHIFT

16 RPT SHIFT FREQ

18 STEP

[OPTION]

2 Bluetooth

3 DEVICE LIST

4 Bluetooth AUDIO

[MEMORY]

1 BANK LINK

2 BANK NAME

3 MEMORY NAME

5 MEMORY SKIP

[GM]

1 DP-ID LIST

[APRS]

6 APRS MSG GROUP

7 APRS MSG TEXT

13 BEACON INFO

15 BEACON STATUS TEXT

17 COM PORT SETTING

18 DIGI PATH

19 GPS SETUP

23 CALLSIGN (APRS)

24 MY POSITION

25 MY SYMBOL

Text input screen

When the radio is first turned on after restoring defaults, the keyboard screen is displayed to enter your own station call sign.

● Character input method

1. Touch a character on the screen to enter it.
2. Touch [→] to move the cursor to right in the text input area.
3. Repeat step 1 and 2 to enter additional characters.
4. When input is complete, press the **PTT** switch to save the characters and return to normal operation.

	@#/&_	abc	def	✕
A	ghi	jkl	mno	Space
123	pqrs	tuv	wxyz	→
INS	a/A	'"()	..?!	←

- Touch [← / →] to move the cursor to left/right in the text input area.
- Touch [INS] to insert a space at the cursor position.
- Touch [✕] to erase the character at the cursor position.
- Touch [Space] to enter a space at the cursor position.

● Alphabet Input

Touch [ABC] to display the alphabet input screen.

Each time [A] / [ABC] is touched, the screen changes as follows:

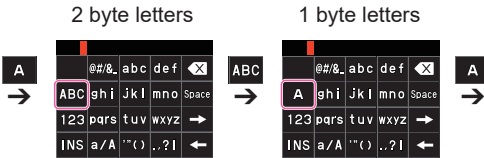

● Number Input

Touch [123] to display the numeric keypad input screen.

Each time [1], [# \$ %], [#], and [123] is touched, the screen changes as follows:

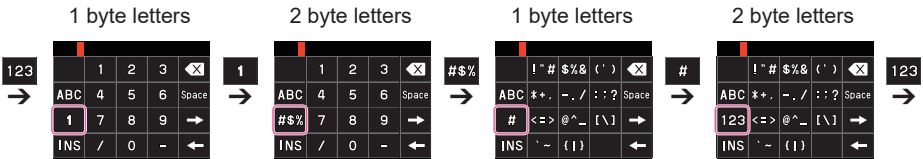

Specifications

● General

Frequency Range	: TX 144 - 148 MHz or 144 - 146 MHz 430 - 450 MHz or 430 - 440 MHz : RX: A- Band 520 kHz - 999.995 MHz (USA Cellular Blocked) B- Band 108 MHz - 579.995 MHz
Channel Steps	: 5/6.25/8.33/9/10/12.5/15/20/25/50/100 kHz (8.33 kHz: only for Air Band, 9 kHz: only for AM Radio)
Mode of Emission	: F1D, F2D, F3E, F7W
Frequency Stability	: ±2.5ppm (-4°F to +140°F [-20°C to +60°C])
Antenna Impedance	: 50Ω
Supply Voltage	: Nominal 7.2 V DC, Negative Ground (SBR-14LI) Nominal 7.4 V DC, Negative Ground (FNB-101LI) Nominal 10.5 - 16 V DC, Negative Ground (EXT DC JACK) Operating 5.5 - 8.4 V DC, Negative Ground (Battery Connect) 4 - 16 V DC, Negative Ground (EXT DC JACK) 10.5 - 16 V DC, Negative Ground (EXT DC JACK, Charging) 3.6 - 4.5 V DC, Negative Ground (FBA-39)
Current Consumption (Approx.)	: 180 mA (Mono Band Receive) 220 mA (Dual Band Receive) 110 mA (Mono Band Receive, Standby) 145 mA (Dual Band Receive, Standby) 74 mA (Mono Band Receive, Standby, Saver On "Save Ratio 1:10") 74 mA (Dual Band Receive, Standby, Saver On "Save Ratio 1:10") +15 mA (GPS On) + 3mA (Digital) 125mA (AM / FM Radio) 600μA (Auto Power Off) 1.6 A (5 W TX, 144 MHz 7.4 V DC) 1.9 A (5 W TX, 430 MHz 7.4 V DC)
Operating Temperature Range	: -4°F to +140°F (-20°C to +60°C)
Case Size (W x H x D)	: 2.44" x 3.94" x 1.34" (62 x 100 x 34 mm) (with SBR-14LI, w/o knob, antenna & Belt clip)
Weight (Approx.)	: 9.95 oz (282 g) (with SBR-14LI & Antenna)
● Transmitter	
Output Power	: 5 W (@ 13.8 V or SBR-14LI) (MID3: 2.5 W / LOW2: 1.0 W / LOW1: 0.3W) 0.9 W (FBA-39) (LOW1: 0.3 W)
Modulation Type	: F1D, F2D, F3E: Variable Reactance Modulation F7W: 4 FSK (C4FM)
Spurious Emission	: At least 60 dB below (@TX Power HI, LOW3) At least 50 dB below (@TX Power LOW2, LOW1)

● Receiver

Circuit Type	: Double-conversion super heterodyne (NFM / AM) Direct-conversion (AM / FM Radio)
Intermediate Frequency	: 1st: A- Band 58.05 MHz 1st: B- Band 57.15 MHz 2nd: A- Band, B- Band 450 kHz
Sensitivity	: 0.52 - 30 MHz (AM)* 3 μ V typ @10 dB SN 30 - 54 MHz (NFM)* 0.35 μ V typ @12 dB SINAD 54 - 76 MHz (NFM)* 1 μ V typ @12 dB SINAD 76 - 108 MHz (WFM)* 1.5 μ V typ @12 dB SINAD 108 - 137 MHz (AM) 1.5 μ V typ @10 dB SN 137 - 140 MHz (NFM) 0.2 μ V @12 dB SINAD 140 - 150 MHz (NFM) 0.16 μ V @12 dB SINAD 150 - 174 MHz (NFM) 0.2 μ V @12 dB SINAD 174 - 222 MHz (NFM) 1 μ V @12 dB SINAD 222 - 225 MHz (NFM) 0.5 μ V @12 dB SINAD 300 - 350 MHz (NFM) 0.5 μ V @12 dB SINAD 350 - 400 MHz (NFM) 0.2 μ V @12 dB SINAD 400 - 470 MHz (NFM) 0.18 μ V @12 dB SINAD 470 - 580 MHz (NFM) 1.5 μ V @12 dB SINAD 580 - 800 MHz (NFM)* 3 μ V @12 dB SINAD 800 - 999 MHz (NFM)* 1.5 μ V @12 dB SINAD Digital Mode 0.19 μ V typ @BER1% * A- Band only Cellular Blocked (USA only)
Selectivity (-6 dB/-60 dB)	: NFM, AM 12 kHz/35 kHz
AF Output	: 1000 mW (8 Ω for THD 10 % 7.4 V DC) internal speaker 500 mW (8 Ω for THD 10 % 7.4 V DC) External speaker

● Bluetooth

Version	: Version 4.2
Class	: Class 2
Output Power	: 2 dBm typ

Specifications are subject to change without notice, and are guaranteed within the 144/430 MHz amateur bands only.

The Bluetooth[®] word mark and logos are registered trademarks owned by Bluetooth SIG, Inc. and any use of such marks by YAESU MUSEN CO., LTD. is under license. Other trademarks and trade names are those of their respective owners.

YAESU LIMITED WARRANTY

Limited Warranty is valid only in the country/region where this product was originally purchased.

On-line Warranty Registration:

Thank you for buying YAESU products! We are confident your new radio will serve your needs for many years! Please register your product at www.yaesu.com - Owner's Corner

Warranty Terms:

Subject to the Limitations of the Warranty and the Warranty Procedures described below, YAESU MUSEN hereby warrants this product to be free of defects in materials and workmanship in normal use during the "Warranty Period." (the "Limited Warranty").

Limitations of Warranty:

- A. YAESU MUSEN is not liable for any express warranties except the Limited Warranty described above.
- B. The Limited Warranty is extended only to the original end-use purchaser or the person receiving this product as a gift, and shall not be extended to any other person or transferee.
- C. Unless a different warranty period is stated with this YAESU product, the Warranty Period is three years from the date of retail purchase by the original end-use purchaser.
- D. The Limited Warranty is valid only in the country/region where this product was originally purchased.
- E. During the Warranty Period, YAESU MUSEN will, at its sole option, repair or replace (using new or refurbished replacement parts) any defective parts within a reasonable period of time and free of charge.
- F. The Limited Warranty does not cover shipping cost (including transportation and insurance) from you to us, or any import fees, duties or taxes.
- G. The Limited Warranty does not cover any impairment caused by tampering, misuse, failure to follow instructions supplied with the product, unauthorized modifications, or damage to this product for any reasons, such as: accident; excess moisture; lightning; power surges; connection to improper voltage supply; damage caused by inadequate packing or shipping procedures; loss of, damage to or corruption of stored data; product modification to enable operation in another country/purpose other than the country/purpose for which it was designed, manufactured, approved and/or authorized; or the repair of products damaged by these modifications.
- H. The Limited Warranty applies only to the product as it existed at the time of the original purchase, by the original retail purchaser, and shall not preclude YAESU MUSEN from later making any changes in design, adding to, or otherwise improving subsequent versions of this product, or impose upon YAESU MUSEN any obligation to modify or alter this product to conform to such changes, or improvements.
- I. YAESU MUSEN assumes no responsibility for any consequential damages caused by, or arising out of, any such defect in materials or workmanship.
- J. TO THE FULLEST EXTENT PERMITTED BY LAW, YAESU MUSEN SHALL NOT BE RESPONSIBLE FOR ANY IMPLIED WARRANTY WITH RESPECT TO THIS PRODUCT.
- K. If the original retail purchaser timely complies with the Warranty Procedures described below, and YAESU MUSEN elects to send the purchaser a replacement product rather than repair the "original product", then the Limited Warranty shall apply to the replacement product only for the remainder of the original product Warranty Period.
- L. Warranty statutes vary from state to state, or country to country, so some of the above limitations may not apply to your location.

Warranty Procedures:

1. To find the Authorized YAESU Service Center in your country/region, visit www.yaesu.com. Contact the YAESU Service Center for specific return and shipping instructions, or contact an authorized YAESU dealer/distributor from whom the product was originally purchased.
2. Include proof of original purchase from an authorized YAESU dealer/distributor, and ship the product, freight prepaid, to the address provided by the YAESU Service Center in your country/region.

3. Upon receipt of this product, returned in accordance with the procedures described above, by the YAESU Authorized Service Center, all reasonable efforts will be expended by YAESU MUSEN to cause this product to conform to its original specifications. YAESU MUSEN will return the repaired product (or a replacement product) free of charge to the original purchaser. The decision to repair or replace this product is the sole discretion of YAESU MUSEN.

Other conditions:

YAESU MUSEN'S MAXIMUM LIABILITY SHALL NOT EXCEED THE ACTUAL PURCHASE PRICE PAID FOR THE PRODUCT. IN NO EVENT SHALL YAESU MUSEN BE LIABLE FOR LOSS OF, DAMAGE TO OR CORRUPTION OF STORED DATA, OR FOR SPECIAL, INCIDENTAL, CONSEQUENTIAL, OR INDIRECT DAMAGES, HOW EVER CAUSED; INCLUDING WITHOUT LIMITATION TO THE REPLACEMENT OF EQUIPMENT AND PROPERTY, AND ANY COSTS OF RECOVERING, PROGRAMMING OR REPRODUCING ANY PROGRAM OR DATA STORED IN OR USED WITH THE YAESU PRODUCT.

Some Countries in Europe and some States of the USA do not allow the exclusion or limitation of incidental or consequential damages, or a limitation on how long an implied warranty lasts, so the above limitation or exclusions may not apply. This warranty provides specific rights, there may be other rights available which may vary between countries in Europe or from state to state within the USA.

This Limited Warranty is void if the label bearing the serial number has been removed or defaced.

Changes or modifications to this device that are not expressly approved by YAESU MUSEN could void the user's authorization to operate this device.

This device complies with part 15 of the FCC Rules. Operation is subject to the following two conditions: (1) This device may not cause harmful interference, and (2) this device must accept any interference including received, interference that may cause undesired operation.

The scanning receiver in this equipment is incapable of tuning, or readily being altered, by the User to operate within the frequency bands allocated to the Domestic public Cellular Telecommunications Service in Part 22.

The YAESU MUSEN is not responsible for any changes or modifications not expressly approved by the party responsible for compliance. Such modifications could void the user's authority to operate the equipment.

This device complies with ISED's applicable license-exempt RSS standard(s). Operation is subject to the following two conditions: (1) this device may not cause interference, and (2) this device must accept any interference, including interference that may cause undesired operation of the device.

Le présent appareil est conforme aux CNR d'Industrie Canada applicables aux appareils radio exempts de licence. L'exploitation est autorisée aux deux conditions suivantes : (1) l'appareil ne doit pas produire de brouillage, et (2) l'utilisateur de l'appareil doit accepter tout brouillage radioélectrique subi, même si le brouillage est susceptible d'en compromettre le fonctionnement.

DECLARATION BY MANUFACTURER

The Scanner receiver is not a digital scanner and is incapable of being converted or modified to a digital scanner receiver by any user.

WARNING: MODIFICATION OF THIS DEVICE TO RECEIVE CELLULAR RADIOTELEPHONE SERVICE SIGNALS IS PROHIBITED UNDER FCC RULES AND FEDERAL LAW.

CAN ICES-3 (B) / NMB-3 (B)

This equipment has been tested and found to comply with the limits for a Class B digital device, pursuant to part 15 of the FCC Rules. These limits are designed to provide reasonable protection against harmful interference in a residential installation. This equipment generates, uses, and can radiate radio frequency energy; and, if not installed and used in accordance with the instructions, may cause harmful interference to radio communications. However, there is no guarantee that interference will not occur in a particular installation.

If this equipment does cause harmful interference to radio or television reception, which can be determined by turning the equipment off and on, the user is encouraged to try to correct the interference by one or more of the following measures:

- Reorient or relocate the receiving antenna.
- Increase the separation between the equipment and receiver.
- Connect the equipment into an outlet on a circuit different from that to which the receiver is connected.
- Consult the dealer or an experienced radio/TV technician for help.

This equipment complies with FCC/IC radiation exposure limits and meets the FCC radio frequency (RF) Exposure Guidelines and RSS-102 of the IC radio frequency (RF) Exposure rules. This equipment has very low levels of RF energy that is deemed to comply without testing of specific absorption rate (SAR).

This transmitter must not be co-located or operated in conjunction with any other antenna or transmitter.

YAESU

Declaration of Conformity

Type of Equipment: 144/430MHz Digital/Analog Transceiver
Brand Name: YAESU
Model Number: FT5DR
Manufacturer: YAESU MUSEN CO., LTD.
Address of Manufacturer: Omori Bell port D building 3F, 6-26-3 Minamioi,
Shinagawa-ku, Tokyo 140-0013 JAPAN

This device complies with part 15 of the FCC Rules. Operation is subject to the following two conditions; (1) this device may not cause harmful interference, and (2) this device must accept any interference received, including interference that may cause undesired operation.

The technical documentation as required by the Conformity Assessment procedures is kept at the following address:

Company: Yaesu U.S.A.

Address: 6125 Phyllis Drive, Cypress, CA 90630, U.S.A.

Telephone: (714) 827-7600

EU Declaration of Conformity

We, Yaesu Musen Co. Ltd of Tokyo, Japan, hereby declare that this radio equipment FT5DE is in full compliance with EU Radio Equipment Directive 2014/53/EU. The full text of the Declaration of Conformity for this product is available to view at <http://www.yaesu.com/jp/red>

ATTENTION – Condition of use

This transceiver operates on frequencies that are regulated. Use of the Transmitter in the EU countries shown in the accompanying table is not permitted without authorization. Users should consult their local spectrum management authority for licensing conditions applicable to this equipment.

					
AT	BE	BG	CY	CZ	DE
DK	ES	EE	FI	FR	EL
HR	HU	IE	IT	LT	LU
LV	MT	NL	PL	PT	RO
SK	SI	SE	CH	IS	LI
NO	–	–	–	–	–

Disposal of Electronic and Electrical Equipment

Products with the symbol (crossed-out wheeled bin) cannot be disposed as household waste.

Electronic and Electrical Equipment should be recycled at a facility capable of handling these items and their waste by-products.

Please contact a local equipment supplier representative or service center for information about the waste collection system in your country.



UKCA Declaration of Conformity

We, Yaesu Musen Co. Ltd of Tokyo, Japan declare our sole responsibility that this equipment complies with essential requirements of the Radio Equipment Regulations 2017, Electrical Equipment (Safety Regulations 2016), Electromagnetic Compliance Regulations 2016 and Restrictions of the use of Certain Hazardous Substances in Electrical and Electronic Equipment Regulations 2012 as appropriate.

YAESU

The radio

Copyright 2024
YAESU MUSEN CO., LTD.
All rights reserved.

No portion of this manual may be
reproduced without the permission of
YAESU MUSEN CO., LTD.

YAESU MUSEN CO., LTD.

Omori Bellport Building D-3F
6-26-3 Minami-Oi, Shinagawa-ku, Tokyo, 140-0013, Japan

YAESU USA

6125 Phyllis Drive, Cypress, CA 90630, U.S.A.

YAESU UK

Unit 4, Concorde Park, Concorde Way, Segensworth North,
Fareham, Hampshire PO15 5FG, United Kingdom

2403u-JS
Printed in Japan

