

The radio... **YAESU**

In Homage to the Founder of Yaesu – Sako Hasegawa JA1MP

FTDX101MP 200W

HF/50MHz TRANSCEIVER

The Ultimate

FTDX101D 100W

HF/50MHz TRANSCEIVER



Ours is an age of “easy” communications via the Internet. Push a button,
and your message is sent without hearing a sound.

Which is precisely why, today, the allure of HF DX communication is stronger than ever.

HF DX involves communication with imagination...

The dream of faraway place and the wonder at how your signal will get to the far side of the world.
The noise, the polar flutter, the echo of the Long Path...and the sudden joy at hearing your callsign
being sent in response to your call.

This is the essence of DX, and only a person who has experienced the thrill can know the thrill.

Drama, emotion, and excitement...

These are the essential elements of the lure of HF DX.

A fundamental human need to know what’s out there.

The magnificence of Nature brings unforeseen ionospheric encounters,
and you prepare yourself for these special moments.
You improve your technical skills, optimize your antennas,
and tweak your rig for the best possible performance.

It’s been said that the destination is not as important as the journey.
Surely this expression was written with Ham Radio in mind...

HF Excitement

Allure of HF DX...

Inherent Passion and Inspiration

*Named after the well-known FT-101,
a corner stone in the history of HF Transceivers,
creating the future of HF communications*

*Birth of the **FTdx101***



True Performance

Hybrid SDRs (Narrow Band SDR & Direct Sampling SDR)

2kHz RMDR 123dB+
 2kHz BDR 150dB+
 2kHz 3rd IMDR 110dB+

400MHz HRDDS (High Resolution Direct Digital Synthesizer)

2kHz Phase Noise -150dBc/Hz

VC-TUNE (Variable Capacitor Tune) signal peaking

3DSS (3-Dimensional Spectrum Stream) visual display

The Ultimate FT DX 101D



HF/50MHz TRANSCEIVER
FTDX101D 100W

• VC-Tune unit (MAIN band) included (For VC-Tune SUB band unit installation, please contact YAESU)
 Supplied Accessories: Hand Microphone SSM-75G, DC Power cable

HF/50MHz TRANSCEIVER
FTDX101MP 200W

• External Power Supply with $\phi 3.94"$ (100mm) Front Speaker, FPS-101 included
 • VC-Tune unit $\times 2$ (MAIN and SUB bands) included / 300Hz CW Filter (MAIN band) included
 Supplied Accessories: Hand Microphone SSM-75G, External Power Supply with Speaker FPS-101

In Homage to the Founder of Yaesu – Mr. Sako Hasegawa JA1MP

FT DX 101MP



In memory of
 Sako Hasegawa, JA1MP
 Founder of Yaesu Musen
 and esteemed friend and colleague of
 the global amateur radio community.

JA1MP commemorative tree at ARRL headquarters

We believe that hearing a weak signal close in to a strong interfering signal environment has been in the past and is today the most important performance requirement of HF DX communications equipment, and is the ultimate mission that Yaesu has been challenging for over 60 years

Hybrid SDR Configuration

In addition to the Narrow band SDR receiver providing excellent fundamental Performance, the Hybrid SDR Configuration also provides a Digital Processing Real-Time Spectrum Scope with Direct Sampling SDR



* Photo: including optional roofing filters

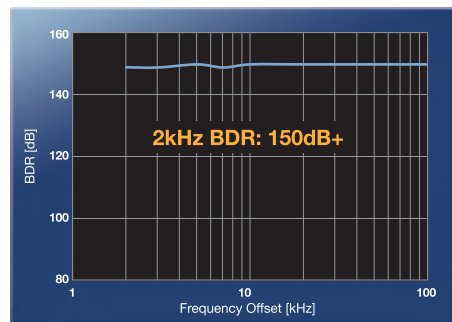

14MHz Band Blocking Dynamic Range (BDR)

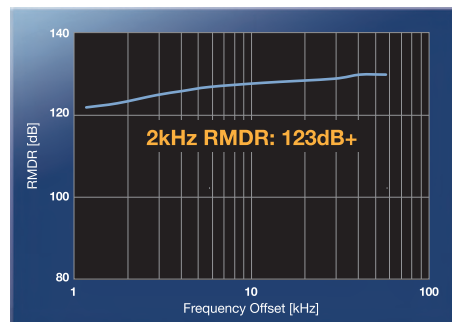

14MHz Band Reciprocal Mixing Dynamic Range (RMDR)

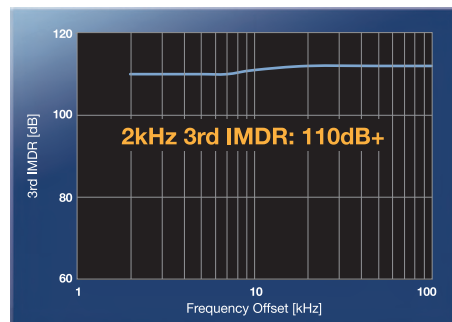

3rd IM Dynamic Range (IMDR)

Narrow band SDR with Crystal Roofing Filters Enable Phenomenal Multi-signal receiving Characteristics

The Down Conversion type receiver configuration is similar to the FT dx 5000. With a low noise figure dual gate MOS FET, D-quad DBM (Double Balanced Mixer) with excellent intermodulation characteristics. Narrow band SDR configuration with the first IF at 9MHz makes it possible to have excellent narrow bandwidth crystal roofing filters that have the desired sharp cliff edge shape factor. These high quality roofing filters enable the amazing multi-signal receiving performance demanded when faced with the most challenging on-the-air interference situations! In addition to the down-conversion configuration,

FT dx 101 has adopted YAESU's legendary powerful RF Front-End, outstanding low-noise Local Oscillator, roofing filter with sharp shape factor and the latest circuit configuration where we have carefully selected all other circuit elements. As a result, the dynamic performance figures are outstanding like the close-in BDR (Blocking Dynamic Range) in the 14MHz band reaches 150dB or more, the RMDR (Reciprocal Mixing Dynamic Range) reaches 123dB or more, and the 3rd IMDR (third-order Intermodulation Dynamic Range) reaches 110dB or more.

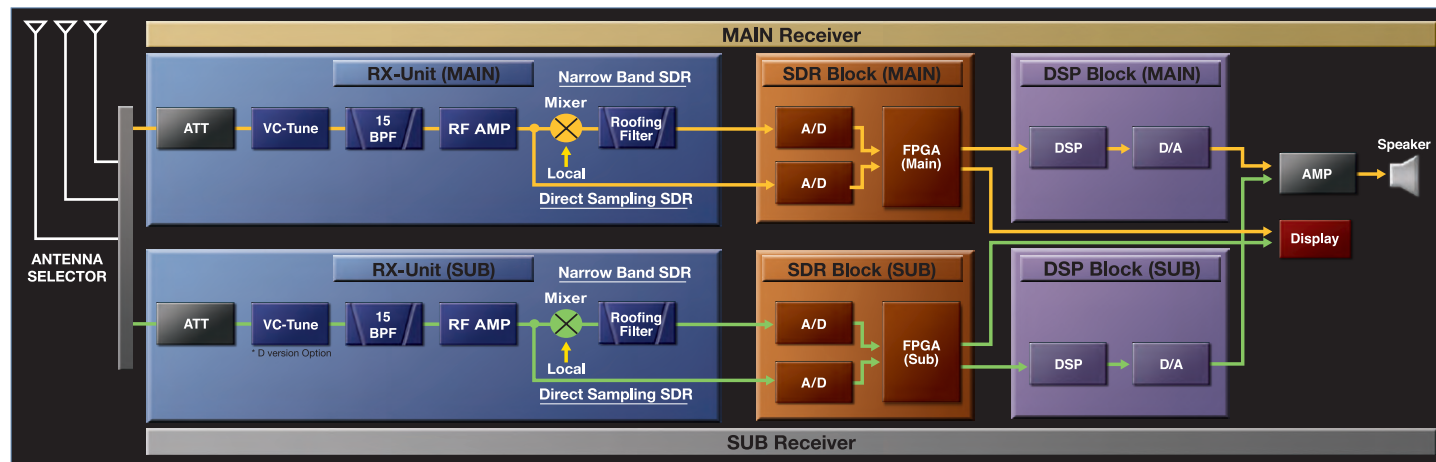
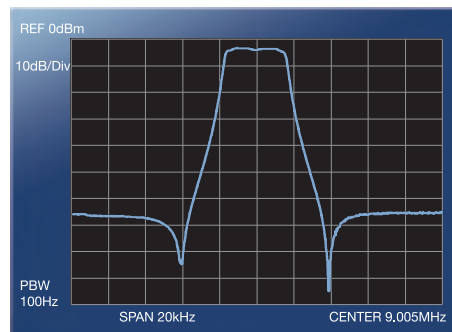
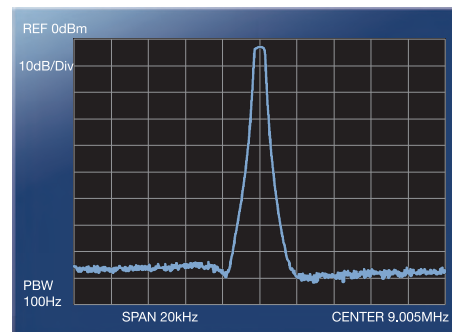
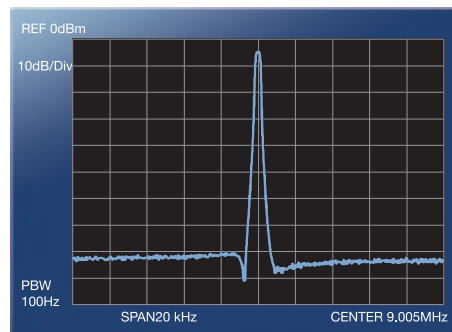

Completely Independent Dual Hybrid SDR

Narrow band SDR & Direct Sampling SDR

Emphasizes Excellent Receiver Performance and Hybrid SDR Functionality Digital Processing Generated Real-Time Spectrum Scope

The Narrow band SDR receiver removes strong out of band signals by using a superheterodyne method, with narrow band roofing filters which significantly attenuates unwanted out of band frequency components, and the wanted signals within the passband are converted to digital by a high resolution 18-bit A/D converter and sent to an FPGA (Field Programmable Gate Array) for signal processing. The FT dx 101 series uses a hybrid SDR configuration that integrates a direct sampling SDR receiver in order to view the entire band status in real time, with the excellent dynamic receiver performance achieved by the narrow band SDR receiver circuit. By using this hybrid SDR design, the overall performance of the entire FT dx 101 receiver system is improved. The Direct Sampling SDR driving the real time Spectrum display with its large dynamic range enables the weakest signal to be observed on the display when it appears and the Narrow Band SDR enables that signal to be selected, filtered and then decoded. If there is powerful AM station near your location or in challenging operating situations where there are a lot of strong signals in the band from Contests, DX-pedition activities, those signals outside the passband can be attenuated by the very effective roofing filter in the front stage of the A/D converter. This reduces the signal load on the A/D converter which is a bottleneck of the entire receiving circuit. Therefore, interference is reduced making it is possible to continue to operate even under such difficult conditions.



FPGA



18-bit A/D Converter

Truly Quiet and Clear Reception

Ultra Low-Noise Local Oscillator System; 400MHz HRDDS (High Resolution Direct Digital Synthesizer)

The C / N ratio (carrier-to-noise ratio) of the local oscillator signal injected into the 1st mixer is an important factor in improving the close-in multi-signal receiver characteristics. The local circuit of the FT dx 101 series uses the 400MHz HRDDS (High Resolution Direct Digital Synthesizer) method as used in the FT dx 5000. This circuit configuration is different from a general PLL that generates a local signal, and by creating a local signal by directly dividing from a high frequency of 400MHz, the theoretical PLL lockup time becomes zero, and C/N deterioration by the lockup time does not occur. The significantly improvement of the C/N characteristic by directly dividing the frequency contributes dramatically to reduce the noise in the entire receiver stage, and so improves the BDR (Blocking Dynamic Range) close-in performance. In the FT dx 101 series, the 400MHz HRDDS latest design characteristics and the careful selection of the components used in the design results in the phase noise characteristic of the local signal achieves an excellent value of -150dBc/Hz or less at 2kHz separation.



400MHz HRDDS Unit

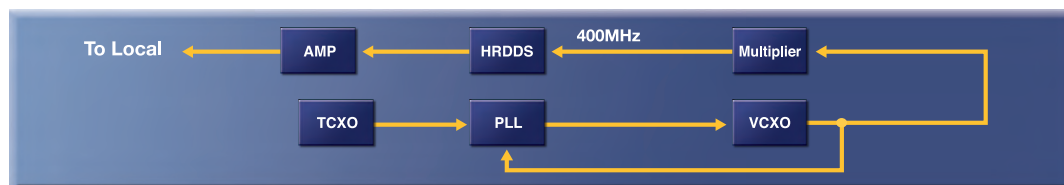
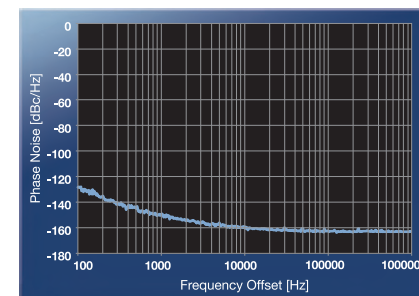

Local Circuit Block Diagram

High Stability TCXO Reference Oscillator

The 400MHz HRDDS reference oscillator circuit adopts high precision TCXO with a frequency stability of ± 0.1 ppm in the temperature range of 14°F to 140°F (-10°C to +60°C), ensuring stable operation. This highly stable high frequency accuracy contributes greatly when operating under harsh conditions such as DX-pedition, and in busy digital data communications signal sub bands such as FT8 and JT65 mode operation.



±0.1 ppm High Precision TCXO

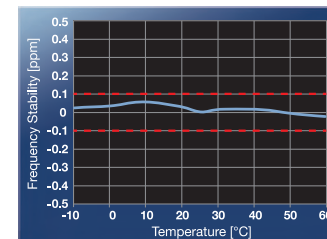

Unparalleled -70dB Maximum Attenuation VC-Tune

Newly developed VC-Tune RF Preselector with high precision stepping motor drive provides outstanding attenuation characteristics

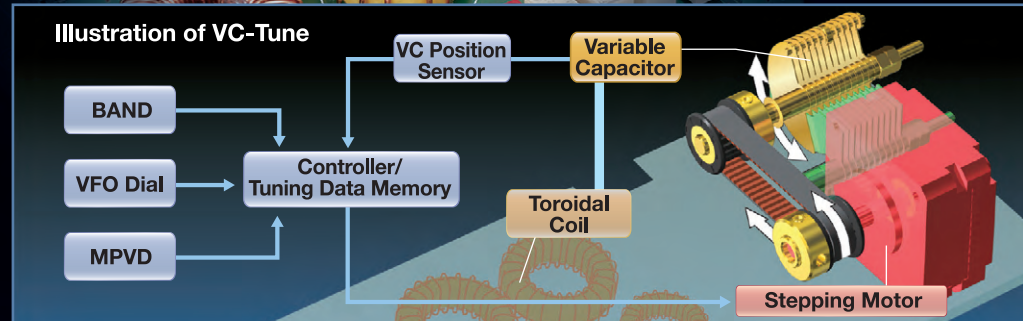

Automatic RF Preselector VC-Tune with a High Precision Stepping Motor

In the FT DX 101 series, a next-generation RF preselector VC-Tune further improves the high performance High Q RF μ (mu)-Tuning system adopted in FT DX 9000, using a remarkable miniaturization design while producing an unparalleled attenuation characteristic of maximum out of band attenuation of -70dB. The Newly developed VC-Tune circuit drives a variable capacitor (VC) with a high precision stepping motor and has achieved a remarkable miniaturization over our earlier μ -tuning system. VC-Tune does not cause any clicks or bangs in the receiver as it operates because it tunes using a variable capacitor driven by a high-precision stepping motor as it follows the receiver frequency, compared to the conventional preset type of switching coils and capacitors by relays which can cause clicks and bangs in the receiver audio. Even when there are multiple strong signals in the band, pressing the "VC TUNE" -key

and turning the MPVD (Multi-Purpose VFO Outer Dial) ring on the VFO dial to drive variable capacitor, you can easily fine-tune to the optimum tuning point that attenuates the strong interfering signal in the band. VC-Tune automatically stores the last tuning point for each band so setting once is all that is needed when that frequency is again selected. The VC-Tune will automatically select the last settings.

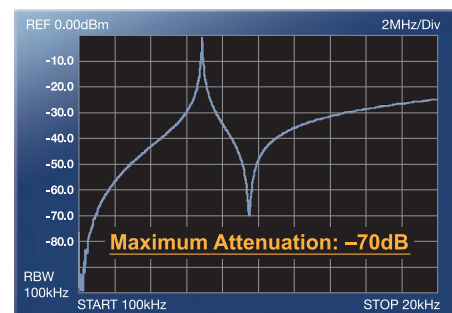
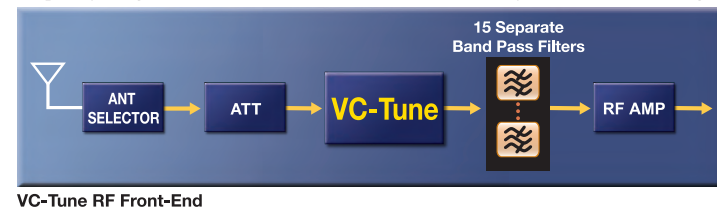

VC-Tune (7MHz, Span 20MHz)

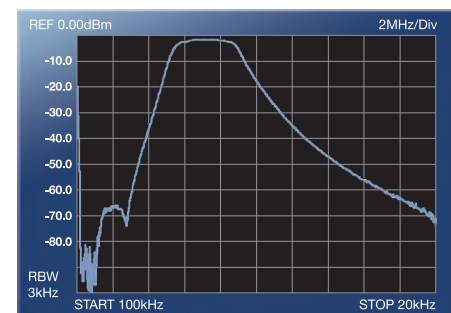

Band Pass Filter (7MHz, Span 20MHz)

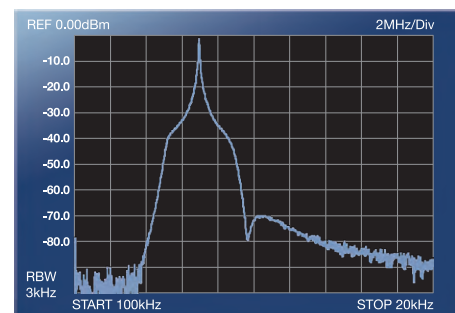

VC-Tune + Band Pass Filter (7MHz, Span 20MHz)

15 Separate (HAM 10+GEN 5) Powerful Band Pass Filters

There are 15 band pass filters (BPF) between the VC-Tune and the RF amplifier stages. These are divided into 10 Band Pass Filters dedicated for the amateur bands and 5 dedicated for GEN (General coverage receive). Band Pass filters are automatically selected according to the frequency band, to eliminate the out-of-band unwanted signals and send the desired signal to the RF amplifier.

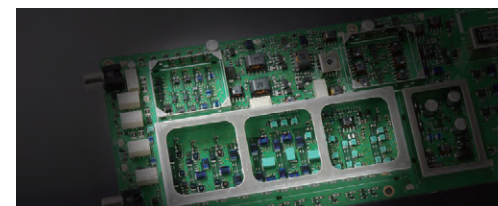

15 Separate Band Pass Filters

Effective QRM rejection with the IF DSP

The 32-bit high speed floating decimal point DSP, TMS320C6746 (maximum 2949 MIPS/ 2220 MFLOPS) made by Texas Instruments, is used for the IF section of the FT DX 101. The signal processor operates at 368.64MHz clock frequency

Yaesu's Renowned Interference Reduction Systems SHIFT / WIDTH / NOTCH / CONTOUR / APF (Audio Peak Filter) / DNR (Digital Noise Reduction) / NB (Noise Blanker) controls are all available on the front panel independently for both the MAIN and SUB band

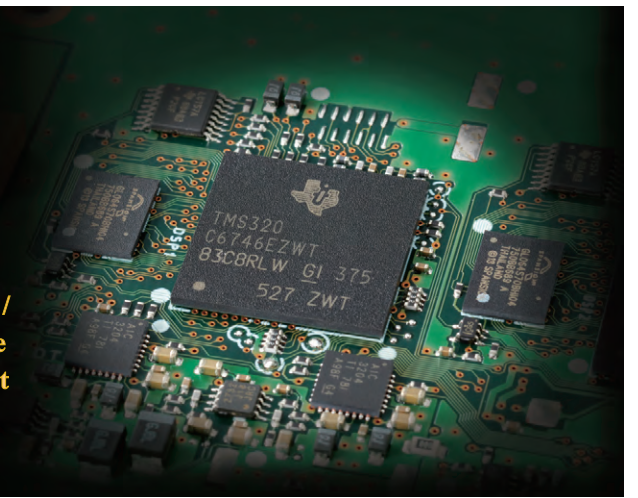

IF SHIFT / IF WIDTH

IF SHIFT: While keeping the bandwidth, the passband relative position can be moved, so that harmful signals are rejected from the low or high side of passband.
IF WIDTH: By adjusting the bandwidth, Interfering signals can be removed from both sides of the passband, without changing the passband position. You can also improve your reception by choosing to narrow the bandwidth of the IF WIDTH function and then varying the passband with the IF SHIFT. The IF SHIFT function allows setting the passband over a range of ± 1.2 kHz in 20Hz steps.

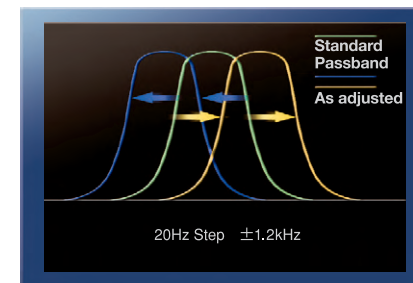

IF SHIFT Conceptual Illustration

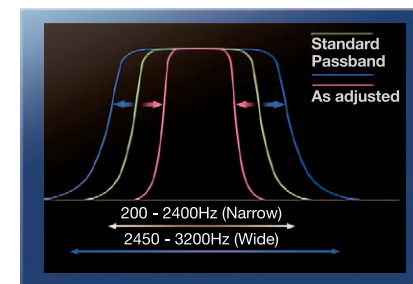

IF WIDTH Conceptual Illustration

IF NOTCH / DNF (AUTO NOTCH)

The IF NOTCH features a very high "Q", and produces a deep notching characteristic, that effectively removes a strong beat signal. The DNF (Digital Notch Filter) automatically follows the interfering heterodyne signals, even if there are more than one, and even if the beat frequency changes with time. This is effective in removing jamming signals. You can choose between NOTCH and DNF depending on the interference condition.

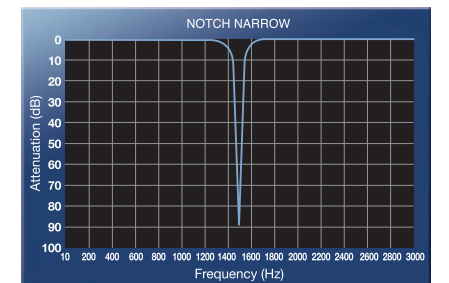
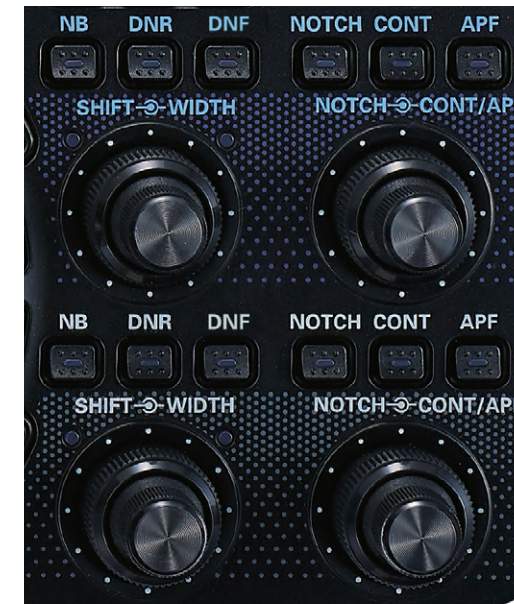

IF NOTCH

APF (Audio Peak Filter)

In the CW mode, the included APF (Audio Peak Filter) function has an audio peak at the signal frequency; this improves the S/N and increases the readability of the CW signal. The APF peak frequency can be finely aligned.

DNR (Digital Noise Reduction)

The digital noise reduction circuit provides 15 separate parameters. The noise reduction constants may be set to the optimal working point by varying the 15 step parameters according to the actual noise within the HF band. The desired signal components are peaked and the random noise components are effectively cancelled.

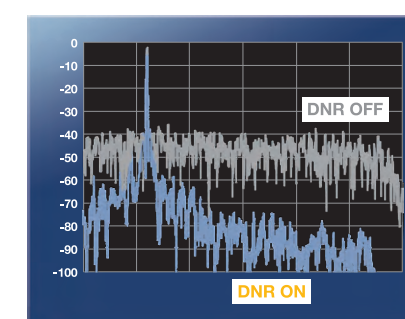

DNR (Digital Noise Reduction)

CONTOUR

The CONTOUR function varies the outline of the IF DSP filter passband characteristics, and the in-band signal characteristics can be partially altered. Unlike the IF SHIFT or IF WIDTH controls which operate on the whole passband, the CONTOUR control can be made to change a specific part in the passband, it can be viewed as similar to the tone control for audio frequencies where Treble or Base frequencies can be boosted or cut, but operates at RF frequencies within the IF passband.

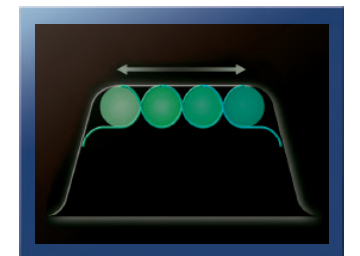

CONTOUR Conceptual Illustration

Signal Purity

High-Quality transmission with outstanding phase noise characteristics



Transmit Final Stage produces the Highest Signal Purity

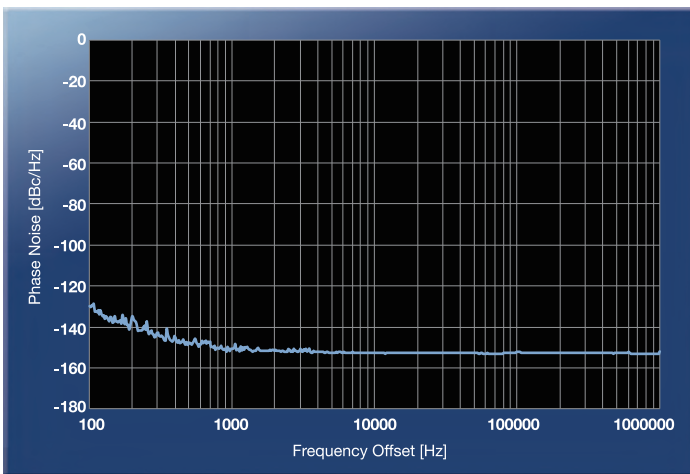

TX Phase Noise (14MHz band, Mode: CW)

The excellent C/N characteristics provided by the 400MHz HRDDS (High Resolution Direct Digital Synthesizer) used in the local oscillator circuit also contributes significantly to the transmitter section. In a generic circuit, noise or distortion may occur depending on the circuit configuration and the components, up to the final stage that is producing the transmit signal, even if the local signal is of high quality. In the FT DX 101, a thorough examination of each element up to the final TX stage was made. The clock-distributor that divides and distributes the local signal from the 400MHz HRDDS circuit to each block, as well as the FPGA, D/A converter, the final power amplifier etc., and carefully selecting the latest circuit configurations to improve the C/N characteristics of the entire transmitter block. The transmit signal of the FT DX 101 is directly generated from a 16-bit D/A converter without passing through a mixer circuit, therefore distortion and noise are significantly suppressed. As a result, high-quality local signal characteristics are maintained without degradation to the final stage, and the transmission phase noise characteristics achieve -150dBc/Hz at 2kHz separation. FT DX 101 transceiver user will appreciate the finest performance with a high-purity transmission signal.

High-Power & Super-stable Final Amplifier

FT DX 101(MP version: 200W) power amplifier utilizes push-pull VRF150 MOS FET devices ($V_{DS}=170\text{V}$, $V_{GS}=\pm 40\text{V}$, $P_D=300\text{W}$), operating at 50V, with excellent linearity, low distortion and high withstand voltage, and by optimizing the bias circuit for the optimal operating points, a high-quality and stable output with low-distortion is realized. FT DX 101 (D version: 100W) power amplifier utilizes push-pull construction with RD100HHF1 MOS FET, and provides stabilized RF power performance.

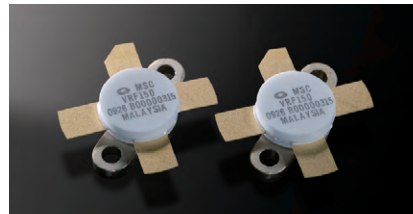

200W Final AMP VRF150 MOS FET

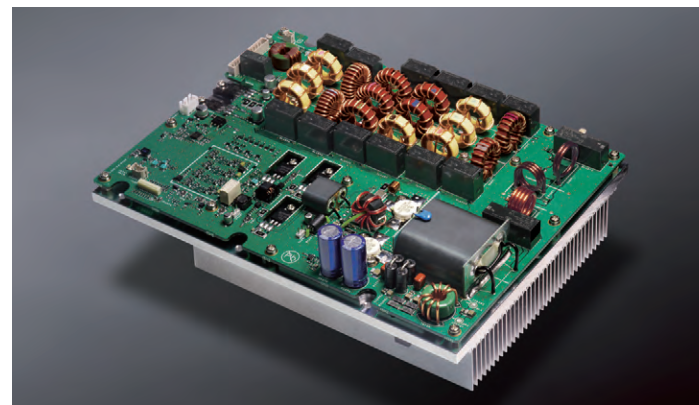

200W PA Unit

A large Aluminum Heat Sink with Low-Noise Cooling Fan

In order to ensure stable transmissions and high output power, the dedicated heat sink of the 200W (MP version) uses an aluminum material with high heat dissipation efficiency to effectively diffuse the heat. The use of a large aluminum die-cast chassis ensures a stable high-power output even in continuous transmission modes and operation under harsh environments. In addition, a 92mm large axial flow cooling fan for the final amplifier is placed at the rear. In long-term operation, the temperature rise inside the cabinet is detected, and the fan starts and the rotation speed automatically adjusted depending on the temperature. The cooling fan uses a large bearing motor with low-noise and rotates at low speed, thereby minimizing the acoustic noise of the fans during night operation. The temperature of the final Power Amplifier can be constantly monitored on the screen of the display.

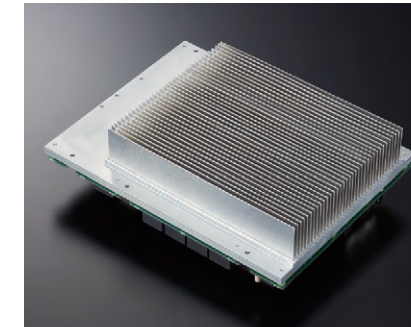

Large Heat Sink (MP version)

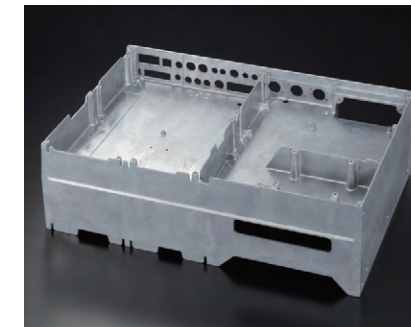

Huge Aluminum Die-cast Chassis

RF & AF Transmit Monitor

By displaying the RF spectrum of the transmit signal after passing through the final amplifier, on the scope screen, it is possible to visually confirm the quality of transmit signal actually emitted. In the MULTI screen display, along with the RF spectrum of the audio transmit signal, the AF-FFT display and the oscilloscope can be simultaneously displayed on one screen. The audio filter characteristics during transmission, and the effect of adjusting the speech processor, and parametric equalizer can be observed. In addition, you can also monitor your own voice, and the CW side-tone during keying operation.

Transmit Status Monitor with Analog Meter Display

Touch the meter display to select the menu meter display to be active while transmitting.

- PO: TX Power Output
- TEMP: Temperature of the FET amplifier section
- SWR, etc.

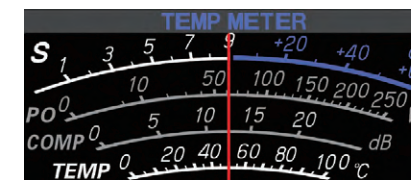

Analog Meter Display

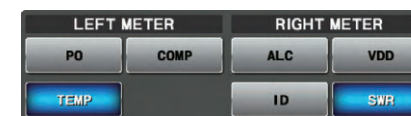

Meter Display Select Menu

High Speed Automatic Antenna Tuner

The FT DX 101 internal antenna tuner uses LC relay switching controlled by a microprocessor. It has a large capacity 100 channel memory, and the tuning data is automatically memorized in the channel memory. The optimized antenna tuning data is immediately recalled to reduce tuning time when changing frequency, and the best matching point is realized.

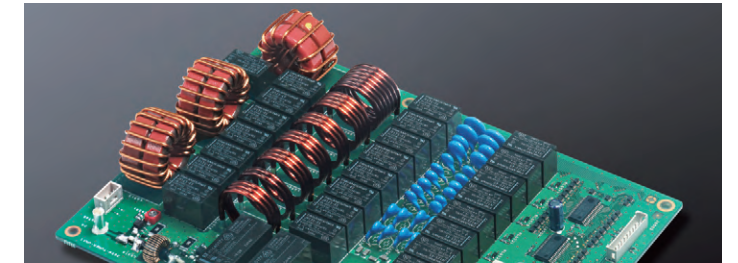

High Speed Automatic Antenna Tuner (MP version)

Microphone Amplifier with Three-Stage Parametric Equalizer (SSB/AM mode)

The modulation circuit of the FT DX 101 utilizes a three-stage parametric equalizer that makes possible versatile digital variations of the TX audio quality, by tuning the TX band audio spectrum. The parametric equalizer can alter the Low, Mid and High audio frequencies separately. This three-stage parametric equalizer can generate high quality TX audio sound, because it can be finely tuned without sacrificing the audio integrity.

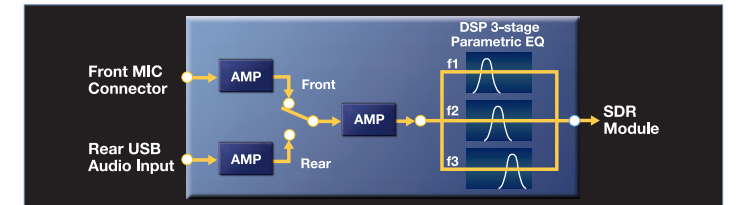

Microphone Circuit Block Diagram

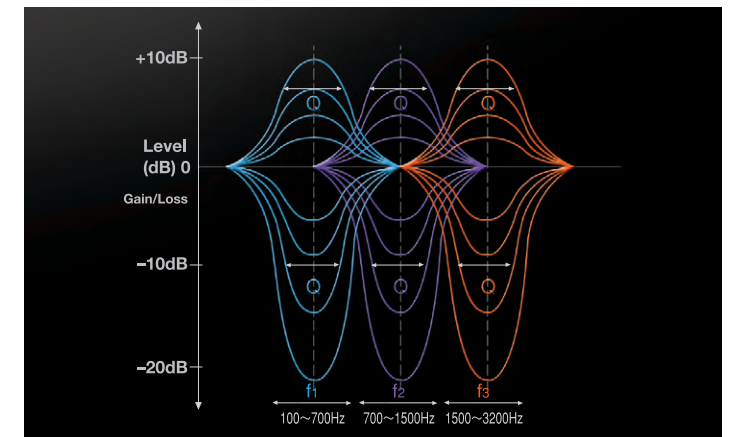

3-stage Parametric Equalizer Conceptual Illustration

Yaesu Renowned Speech Processor

The SSB Speech Processor uses IF digital signal processing to increase the intelligibility of the transmitted signal during weak signal crowded conditions. The DSP increases the average power of the important speech spectrum components, and reduces the TX power of the less significant components. The compression level may be adjusted with the dial on the front panel to adapt the transmitted SSB signal to best suite the situation, propagation conditions and pile-up. The setting can be selected from COMP (SSB mode) which adjusts the compression level, or AMC (Auto Mic Gain Control) function (SSB, PSK/DATA, AM mode) which adjusts the level automatically when the voice input is excessive.

New Generation Scope Display 3DSS

Intuitively grasp changes in the strength of the signals
Newly developed 3DSS (3-Dimensional Spectrum Stream) system
in addition to a conventional Waterfall display

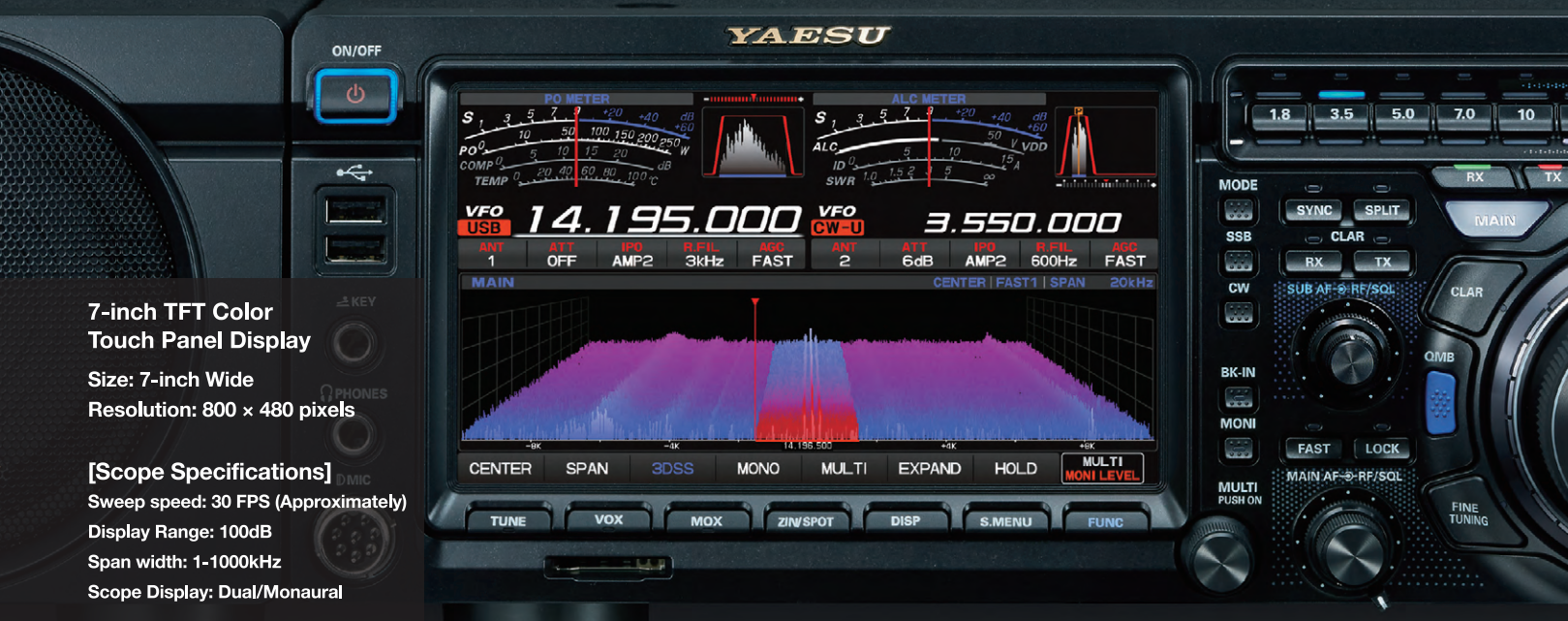

7-inch TFT Color
Touch Panel Display
Size: 7-inch Wide
Resolution: 800 × 480 pixels

[Scope Specifications]
Sweep speed: 30 FPS (Approximately)
Display Range: 100dB
Span width: 1-1000kHz
Scope Display: Dual/Monaural

The 3DSS display is a remarkable completely new system that displays the constantly changing band conditions in three dimensions (3-D) with the frequency as the horizontal axis (X axis), the signal strength as the vertical axis (Y axis), and the time as the Z axis. The operator can intuitively view the constant changes in a signal's strength as the signal flows to the back of the screen giving a sensation of traveling in Time and space.

The 3DSS exhibits a colorful easily viewed presentation that contains the outputs from both the Narrow band SDR and the Direct sampling SDR within one common screen. The operator can effectively see the close-in QRM situation from the Narrow band SDR output while at the same time easily observe activity across the whole band from the Direct sampling SDR output.

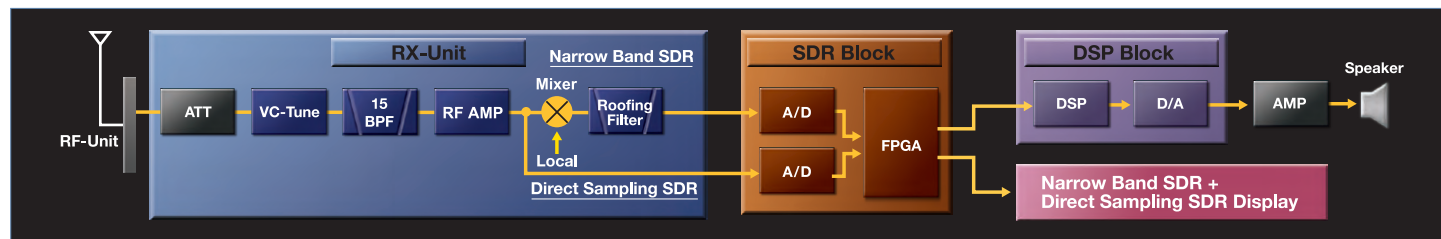

Hybrid SDR Configuration



3DSS (3-Dimensional Spectrum Stream)



3DSS Color Select Screen



(Example)
Extended Image for Narrow Band SDR Output Area

Versatile Display Configurations Designed for the Situation

FT dx 101 provides a variety of display configurations depending on the priorities and the situation. As a single band display, Monaural (MONO) shows only the information of the MAIN or the SUB receiving frequency band. The Dual (DUAL) presents both the MAIN and the SUB band status in dual reception. The Dual display of the scope screen divides the information of the MAIN band and the SUB band vertically or horizontally. The "EXPAND" screen mode that expands the image of the scope. The status of the filters can also be expanded to make fine adjustments easily.



MONO Display

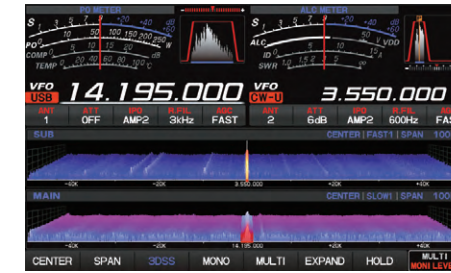

DUAL/Vertical Display

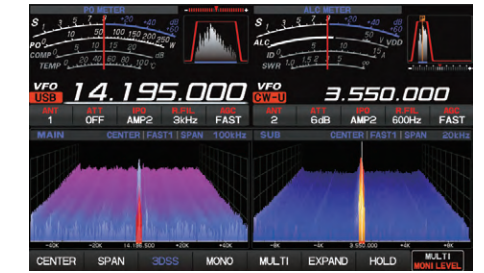

DUAL/Horizontal Display

MULTI Display

The MULTI Display mode allows the oscilloscope and the AF-FFT audio scope to be shown on the screen, in addition to the RF Spectrum Scope display. In MULTI display, while monitoring the receive band, a simultaneously view the contact station's transmit signal audio characteristics can be viewed with the AF-FFT function. At the same time the IF filter and interference reduction functions can be checked for their influence on the receive signal visually on the MULTI display, even in Contest, etc. The display can easily check the transmitter audio characteristics, it is very effective to monitor adjustment of the parametric equalizer.



MULTI Display

Filter Function Display & Expand Feature

In the upper part of the display, separate Analog-meter and Filter function displays for both the MAIN and SUB bands are available at all times. The filter function displays show in-band information from the DSP as well as the operation status of the interference reduction function. You can check the operating status of WIDTH, SHIFT, NOTCH, and CONTOUR at a glance, as well as check the status of the spectrum within the passband.

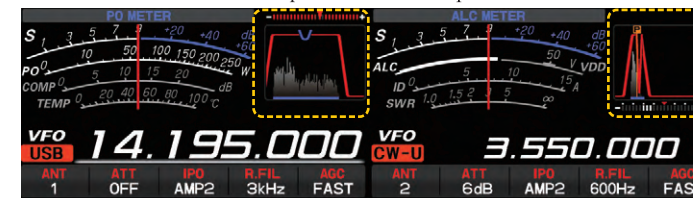

When the "DISP" key is pressed, the scope display is switched to the enlarged image of the filter section, and the interference reduction functions can be adjusted while viewing their effect on the scope display in the band.



Expanded Filter Function Display

Rx Operation Status Display

The receiver status display, shows the current receiver status and settings of the MAIN and SUB bands at a glance. The settings of connected antenna terminals, attenuators, and roofing filters, are displayed at the center of the screen to support efficient operating.



Versatile Scope Operating Modes

Center Mode (CENTER)

The receive frequency is always at the center on the screen and displays the spectrum within the range set by "SPAN". The CENTER mode is a convenient view to monitor the spectrum around the operating frequency.



CENTER Mode

FIX Mode (FIX)

The FIX mode is convenient when operating within a fixed band. The display is fixed between the frequencies set in "SPAN" according to the band plan etc. By pressing and holding the "FIX" key, the start frequency of the scope may be input. Enter the band to be monitored with the SPAN setting. In FIX mode and CURSOR modes, when there are many signals in the band, marker trajectories are clearly visible on the 3DSS display, enabling efficient signal tracking.



FIX Mode (Direct Frequency Input)



FIX Mode

Cursor Mode (CURSOR)

Monitors the spectrum within the range set with "SPAN". When the frequency (marker) exceeds the upper limit or the lower limit of the range, the screen is automatically scrolled and the spectrum outside the setting range can be observed.



CURSOR Mode

ABI (Active Band Indicator) & MPVD (Multi-Purpose VFO Outer Dial)

Deliver Superior Operability and Visibility
Instant Access to Numerous Functions

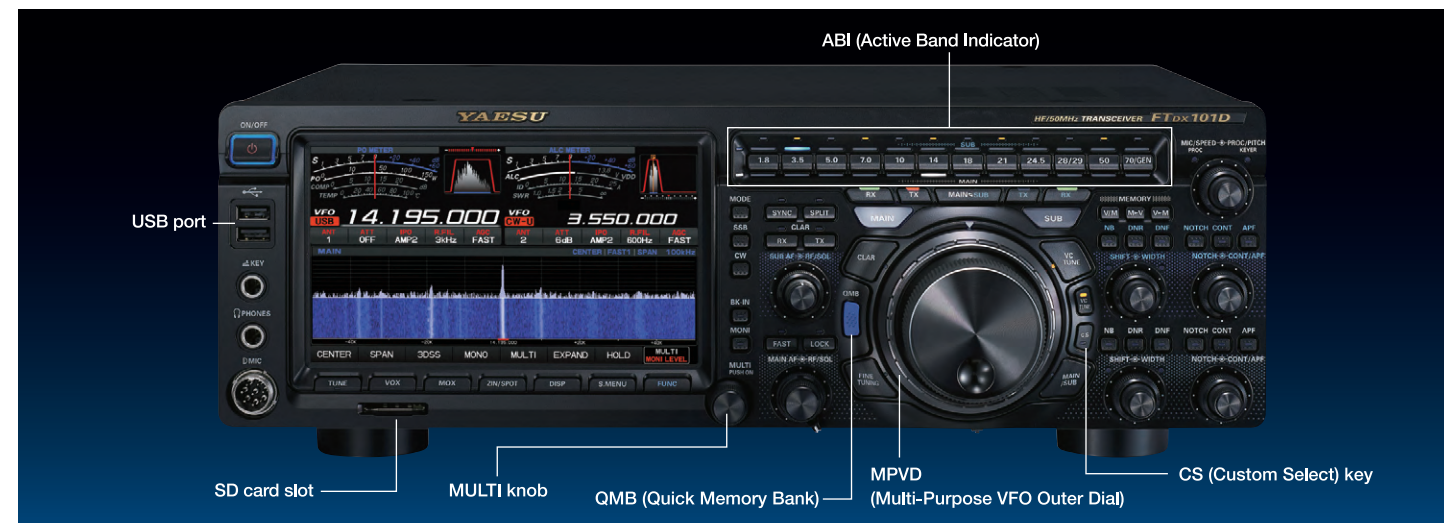

Front Panel Design Emphasizes Solid Superior Response and Operability

Important primary operation functions, such as the Main VFO dial, VC-TUNE and WIDTH/SHIFT are arranged near the center of the panel for easy access. Band select keys are placed in a row on the ABI (active band indicator) above the VFO dial, for operating efficiency and comfort. On the large 7-inch Touch Panel Display, the panel layout emphasizes quick visibility and operability as a First Priority.

ABI (Active Band Indicator)

ABI indicators are arranged as the band select keys in a horizontal row above the VFO dial. When the MAIN Band is selected, the LED indicates in white, and when the SUB Band is selected, the LED indicates in blue. When transmit is keyed, the LED turns red and you can instantly confirm which VFO is transmitting. In addition, since the orange LED lights up when you press and hold the band key, you can use it to display a band that has an antenna connected or to display a band operated in DX-pedition mode as a memo. Below the band key is a key for selection between transmission and reception of the MAIN and the SUB band, and below that, there is a switching key for using the VFO knob on the MAIN or SUB tuning. Even when the operating on the MAIN and SUB bands at the same time, the band control can be performed smoothly, and erroneous operation in tuning is reduced.



MPVD (Multi-Purpose VFO Outer Dial)

The MPVD is a large high-grade aluminum multifunctional ring around the outside of the VFO dial. The ring allows control of SUB VFO frequency dial, VC-TUNE, Clarifier and C/S (custom select function). The MPVD is a handy dial that allows you to adjust important functions in ever-changing HF communications without taking your hand off the VFO. The ring has the traditional Yaesu outstanding smooth and solid feeling when used.



CS (custom select) key

The CS (custom select) key can call an often needed function with a single touch by assigning it in advance from the user menu. Functions assigned as CS can use the MPVD dial to make configuration changes and adjustments.



- Available selection items:
- Transmit Power Output setting
 - Monitor level setting
 - Noise Blanker level setting
 - Anti VOX setting
 - Memory channel selection
 - Roofing filter pass bandwidth selection
 - DNR level setting
 - VOX gain setting
 - VOX delay setting
 - Frequency change at pre-setting step
 - Memory group selection

LED indicators and Adjustment Knobs are Arranged Independently for the MAIN and SUB band

Multicolored LED indicators and adjustment knobs show clearly whether they apply to the Main band (White) or Sub band (Blue) controls by color, thus enabling easy identification by band and function when adjusting for band conditions.



MULTI knob

MULTI knob can easily select items in the setting menu, or change setting values, etc. The MULTI-turn knob can be pressed to quickly select an item and then adjust the setting values or levels with the one knob. A function or setting menu that is used frequently may be assigned, so it can be accessed quickly and the setting made by simply turning the knob.



QMB (Quick Memory Bank) Function

QMB key is located to the left of the VFO dial, it can be used to store the dedicated memory channel (QMB: Quick Memory Bank) with one touch, and also the memory can easily be recalled. The Quick Memory Bank stores the frequency and mode, and also the transmit/receive settings, filters and other settings, so operating may begin quickly on the band, in the best condition, without re-setting. Memory settings can be easily checked by listing the memory contents on the display. (Up to 10 channels of memory available)



Band Stack Function

The FT dx 101 employs a triple band-stack function that stores up to three favorite frequencies and modes for each band. The function is very effective when operating on the same band but changing the frequency or mode, such as DX-pedition or contest.

Instant Frequency Setting by Scope Screen

In addition to the frequency changes performed by the VFO dial, the FT dx 101 supports ten key inputs using touch panel operation in the frequency display section, and also the frequency can be moved by touching the peak of the desired signal on the scope screen display, the frequency is instantly moved to the desired signal.



Receiver Status Display with One Touch Switching

The status of important receiver operations, such as antenna selection, attenuator and roofing filters are shown on the display, where they can always be confirmed. To change a setting, touch it, and then select the appropriate type or value on the display.

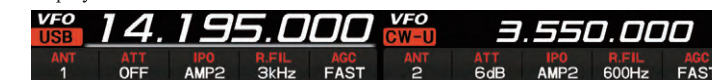

Remote Keypad FH-2 provides Convenient Message Memory Control

The optional remote control keypad (FH-2) supports the message memory function that records and transmits short voice messages. It also supports the contest memory keyer used for CW operation to transmit short messages automatically in contests etc.



Equipped with USB Ports

Two USB ports (A type) on the front panel are available to use for operating the transceiver and inputting text with a connected mouse and keyboard.



SD Memory Card Slot

Use a commercially available SD Memory Card to save the transceiver settings, the memory contents, and screen capture image. The CD Card is also used to update the firmware.



Supports Enjoyable CW Operation

CW zero-in Display

The TX CW side tone pitch frequency can be adjusted using the PITCH knob anywhere between 300Hz and 1050Hz. This pitch tone frequency is used as the reference in transmission, and so ensures that there is no difference between the TX and RX pitch. In addition, the FT DX 101 has the CW tuning bar-display. By using this function, when the pitch of the receiving CW signal becomes close to the programmed pitch, the pitch mark on the bar-display moves closer to the center from right or left side of the display depending on whether the received pitch is higher or lower than the programmed pitch, and when the pitch mark is on the center, you can visually confirm the signal is zero beat with the programmed pitch.

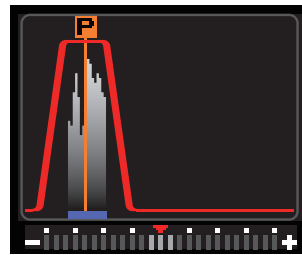

CW zero-in (Bar display)

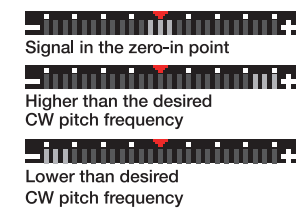

Signal in the zero-in point

Higher than the desired CW pitch frequency

Lower than desired CW pitch frequency

CW Auto zero-in

CW Auto Zero-in measures the frequency of the received CW signal and tunes the beat frequency Oscillator to match the programmed pitch frequency automatically (auto-zero-in). Even for the experienced operator, it is sometimes difficult to zero beat just by listening, but this function enables zero-beat automatically with one-touch, and so the operator can start the QSO very quickly.

CW Reverse

During CW operation, if there is interference in the received signal, CW reverse function provides a means of removing the temporary interference by inverting the side band.

Other CW Features

- Two Key jacks on the front and rear panels
- Built-in Electronic Keyer (keyer mode selection: A / B / Y / ACS)
- Bug keying emulation
- Keyer Weight control
- Keyer paddle Dot-Dash reversal
- Contest number auto count up

CW Decode

The FT DX 101 CW Decode function can decode the Morse code and show the characters and text on the display.

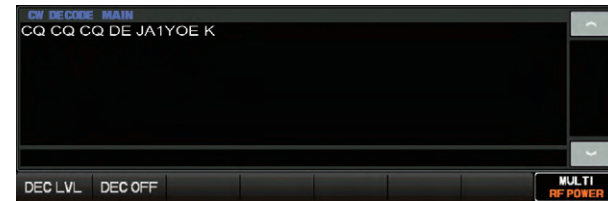

CW Decode display

APF (Audio Peak Filter) Function

The audio peak filter automatically adjusts the center frequency to the pitch frequency when there is interference or noise during CW operation. Thereby improving the S/N of the CW signal and reducing the effects of noise and interfering signals, making it easier to hear the desired signal. The APF function can be operated separately for the MAIN band and the SUB band.

CW Keying Signal form Shaping by FPGA

The rise/fall time of the TX signal (transmit signal waveform) during CW keying can be adjusted in 4 steps. In each setting, signal shaping by FPGA digital processing can produce a transmit signal with an ideal shape.

Contest Memory Keyer

The memory keyer has a "MESSAGE memory" that saves the CW code as directly input by the paddle, and a "TEXT memory" that saves text that is input with the display keyboard. The memory has 5 channels (up to 50 characters) that can store the CW code. The stored contents can be converted to the CW code and sent out. The contest memory keyer can perform various operations from the display panel, or from the optional remote-control keypad FH-2.

- Beacon function to transmit stored CW code continuously at fixed intervals
- CW full break-in
- CW semi break-in
- CW delay time selection (30 msec to 3000 msec)
- CW keying speed control (4 wpm to 60 wpm)
- CW direct keying function in SSB mode
- CW SPOT

RTTY (FSK)/PSK Encode/Decode Function

The FT DX 101 has a built-in encoder and decoder of FSK and PSK (BPSK / QPSK) digital messaging communication modes and so can operate in RTTY and PSK31.

RTTY Encode/Decode function

The RTTY decoding and encoding functions can be easily tuned to the received signal using the marker on the filter function that is displayed together with the decoding screen. Mark frequency, SHIFT width and the baudot code can be changed in the setting menu. Also, by connecting the FT DX 101 to a PC with a commercially available USB cable (A-B), permits RTTY operation using commercially available data communication software.

RTTY/PSK Text Memory

RTTY text memory and PSK text memory (each with a maximum of 50 characters × 5 channels) can store sentences that are frequently used in RTTY and PSK transmission. The pre-stored messages can easily be transmitted using the touch panel operations. It is also possible to connect an optional FH-2 (remote control keypad) to record and transmit text memory.



Other Practical Features

Optimal RF Gain selection by IPO (Intercept Point Optimization)

Depending on the connected antenna and the received signal condition, the gain of the RF amplifier section can be selected from three operating states to input a signal of the optimum level to the mixer. In particular, IPO is effective in severe reception conditions encountered on the low frequency bands. AMP1 (gain approx. 10dB) provides a balance of sensitivity and characteristics by connecting one stage of RF amplification. AMP2 (gain approx. 20dB) utilizes two stages of RF amplifier with emphasis on sensitivity.

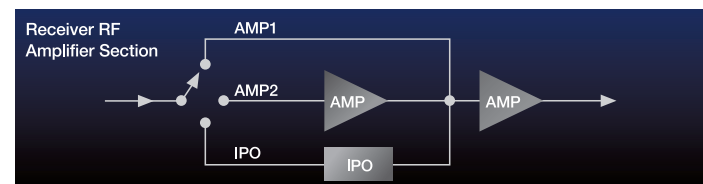

AGC (Automatic Gain Control) Function

AGC automatically adjusts the overall gain of the receiver according to the strength of the received signal. This prevents the receiver from saturating and causing distortion. In AUTO mode, the time constant is automatically switched according to the operating mode. However, when there is noise or fading, the time constant of the AGC circuit can be switched according to the situation to receive in an optimal state. The AGC setting is stored for each band stack.

Quick and Sync Functions make SPLIT Operation Effortless

The quick-split function enables using different frequencies set to the MAIN band and SUB band, this supports smooth and comfortable operation during DX-peditions.

Quick Split Function

Set the receive frequency in the MAIN band then press and hold the "SPLIT" key. The transmit frequency is set 5kHz (initial setting) higher than the receive frequency, and the split operation can be performed quickly. (Set or change the offset frequency in the setting menu.)

Quick Split Input

When quick split input is selected in the setting menu, you can hold down the "SPLIT" key and specify the offset frequency with the touch panel operation on the screen.

Sync Function

By pressing the SYNC key, you can change the MAIN and SUB band frequencies simultaneously. Also, by pressing and holding the sync (SYNC) key, the frequency of the MAIN band and the frequency of the SUB band can be made the same with one touch.

92mm Exceptional Sound Quality Built-in Speaker

The large-diameter 92mm built-in speaker faithfully reproduces the received signal with high sound quality design. The pleasant audio will reduce operating fatigue, even in extended operations or contests etc.

Hand Microphone with Keys SSM-75G (Supplied Accessory)

The hand microphone (SSM-75G) can perform band selection with one touch. It provides the microphone, a transmit PTT key, and seven function keys.

- Frequency UP/DOWN
- SUB band selection
- SUB band TX selection
- MAIN band selection
- MAIN band TX selection
- MUTE

Compatible Long Wire Auto Antenna Tuner (FC-40)

A tuner terminal on the rear panel supports the FC-40 auto antenna tuner that can match a wire 20m or more in length to amateur bands 1.8MHz to 30MHz, 50MHz to 54MHz. Matching frequencies are stored in 200 matching memories making tune-up much quicker when returning to a previously used operating frequency. (Support for up to 100W input)

Extensive External input/output connections

Equipped with 3 Antenna Terminals to Accommodate Various Antenna Arrangements

Three antenna connectors are provided on the Rear panel. The antenna configuration can be switched with one touch to change the operating antenna connection, such as when using a receive-only antenna or a transmit/receive antenna in a contest etc. The ANT1 & ANT2 terminals can be used for transmission and the ANT3 terminal can be set to receive only to connect an antenna. The setting information of the antenna terminals is automatically stored for each band, and the antenna is switched to the optimum antenna by changing the band. The antenna selection display is easy-to-understand and reduces the possibility of erroneous operation.



Output Terminal (RX-OUT, IF-OUT) for External Device Connection

MAIN and SUB Bands are independently equipped with RX-OUT and IF-OUT terminals for external device connection. The RX-OUT signal is after the RF amplifier, and IF-OUT outputs the 9MHz IF signal. Output signals can be used in various applications such as receiving the same band with an external receiver and connecting to various external SDR devices.

Reception

- 30kHz to 75MHz general coverage reception function (Performance is not guaranteed for frequencies other than in the amateur bands)
- FM/AM wide/narrow mode
- Data communication such as RTTY/PSK, External connection terminal
- ATT (Attenuator)
- NB (Noise Blanker)
- Scan function: VFO scan, memory scan, PMS (Programmable memory scan)

Transmission

- VOX (Automatic voice transmission)
- VOX gain adjustment / Anti VOX gain adjustment
- MOX (Transmission hold)
- TOT (Timeout timer)
- TX Monitor
- CTCSS encoding (50 codes in FM mode)
- Voice Memory (voice recording for transmission: up to 20 seconds × 5 channels)

Operability

- Adjustment of VFO dial torque
- Frequency shift by touch panel operation
- Numeric keypad frequency input
- Main dial lock
- Screen capture
- Band stack function (Stores the settings without switching the operating band (3 memories per band))
- Keyboard LANGUAGE (input language) selection

Display

- Receiver operation status display
- Scope display sweep speed variable
- Function menu display
- Frequency display font setting (Bold or Fine print)
- Various meter display selections (PO / COMP / TEMP / ALC / VDD / ID / SWR)
- Screen saver
- EXPAND display function to extend the scope display image vertically
- Spectrum resolution selection for scope display

External Display

An external display terminal (DVI-D) on the rear panel provides a digital video output for connection to a large screen monitor.

ACC Terminal

An optional LAN unit can be connected to the ACC (Accessory) terminal to perform remote operation via a LAN or the Internet.

External Speaker Terminal (A / B)

Two external speaker terminals are provided, and by connecting external speakers to terminals A and B, you can control the audio output destination between the external speakers and the built-in speakers.

Linear Amplifier Connection Terminal

A dedicated terminal for connection to a 1kW linear amplifier (VL-1000), and can be connected to the VL-1000 via the CT-178 (sold separately) for coordinated operation by sharing band data.

PC Remote Control Software

Expand Operating to Remote Locations

Dual Band-Scope available even from a distance
Remote Operation utilizing advantages of the Hybrid SDR

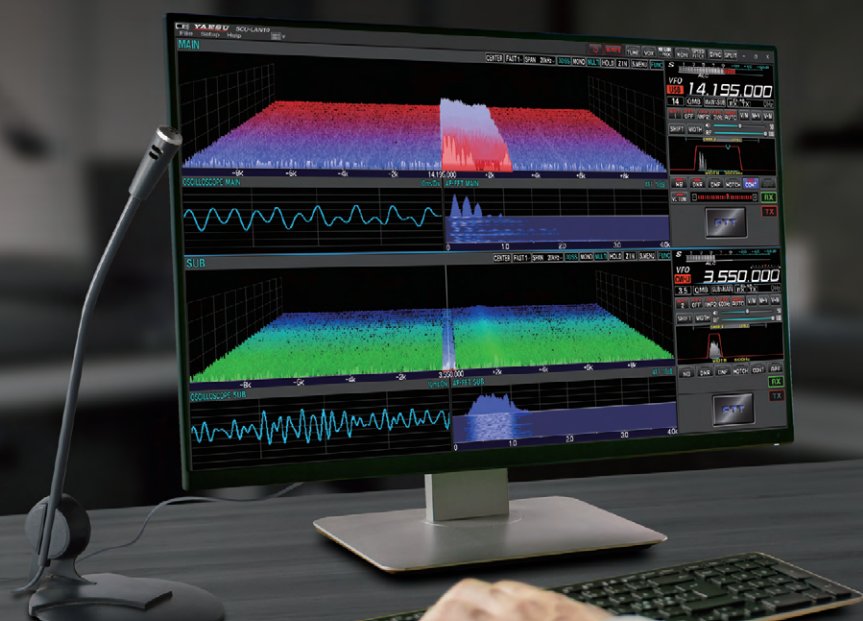

Remote Operation with a LAN or Internet Connection

PC control software is available that permits remote operation of the transceiver from a remote location via the LAN or the Internet. (Requires optional external LAN unit) In remote operation, as well as the transceiver basic operations, the compatible DUAL-BAND scope and versatile displays enable sophisticated operation. Also, there are various enjoyable uses such as monitoring the band conditions on a large display at a location away from the "ham shack", by connecting to a home LAN network.



By communicating the transmit/receive voice, RF scope, AF scope and control commands to the transceiver; the band status monitor scope display, the various filter settings, interference reduction functions etc., can be easily set from the PC. It is possible to operate communications comfortably from any remote location.

Flexible Operating Panel Layout may be Customized by User

Using the PC mouse, the layout of the operating panel on the PC screen can be enlarged or reduced according to preference. The layout on the screen can also be arranged on the right or left side of the scope display. The upper and lower positions of the MAIN Band and SUB Band can be alternated. When used as a band monitor, the display scope may be expanded to full-screen without the operating panels. Create the best panel display arrangement depending on the situation, from monitoring the band activity at a little distance while in the shack, to displaying the frequency spectrums on a large screen at a remote location.

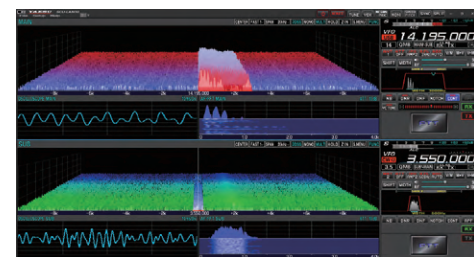

MULTI Display (DUAL)

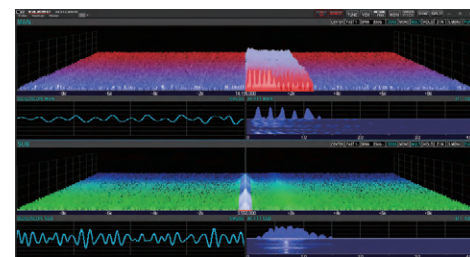

MULTI Display (DUAL), Scope Full-screen

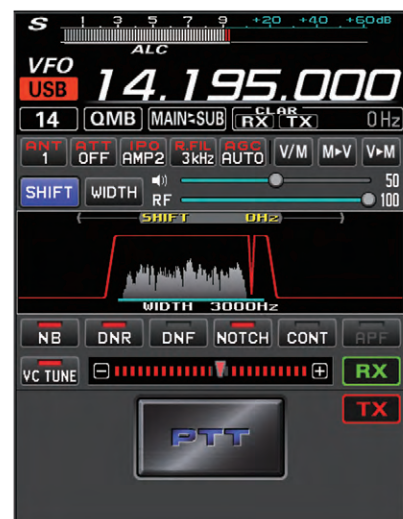

Operating Panel on PC screen

DUAL Band Scope Display & MULTI Display

The scope function provides a MONO display in which only the active band is enlarged and presented on the full PC screen. Alternately, in the DUAL display, the MAIN and SUB band scope screens are displayed simultaneously. The new 3DSS spectrum scope function is supported, and utilizes all the operating advantages of the hybrid SDR. The narrow receive band of SDR is displayed in detail, while also monitoring the signals of the entire band in direct sampling SDR, even from a remote location. The conventional waterfall display, and the various color selections of the scope screen are available as the users prefer. In MULTI mode, an oscilloscope and AF-FFT are displayed on the Band scope, and you can select MONO display or DUAL display. With the MULTI on DUAL display, the best tuning can be achieved while also checking the entire band condition of the MAIN and SUB bands. The status of the transmit and receive audio of both bands, may also be displayed.

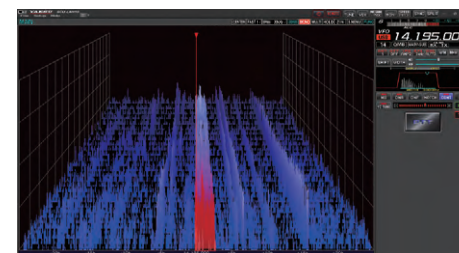

Scope Display (3DSS/MONO)

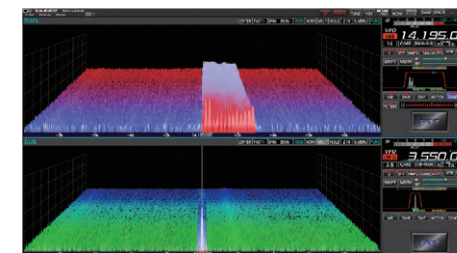

Scope Display (3DSS/DUAL)

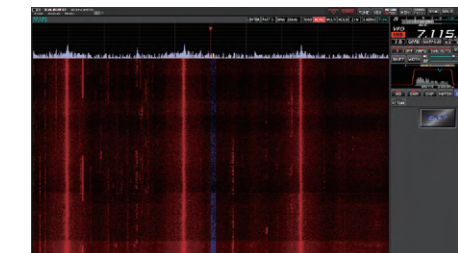

Water Fall Display (MONO)

Valuable Features in Remote Operation

- MAIN/SUB transmit/receive operation
- Roofing Filters & Interference Reduction functions
- Dual scope function
- Spectrum Scope (3DSS, Waterfall Display)
- MULTI Screen Display (Spectrum Scope/Oscilloscope/AF-FFT)
- Memory Channel Function
- Shortcuts Operation with keys on the PC keyboard
- Others

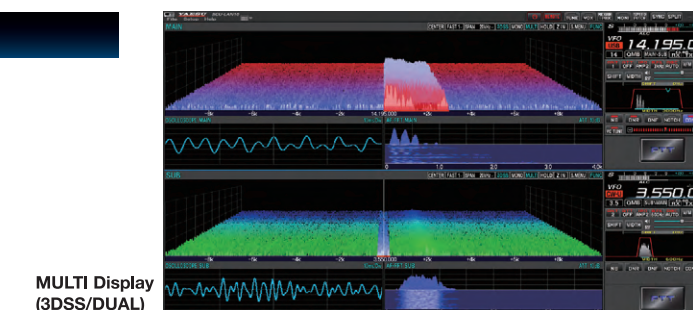

MULTI Display (3DSS/DUAL)

Network Remote Control System LAN Unit

This external LAN Unit is an interface unit for transceiver remote operation via LAN or Internet, from a Personal computer with PC control software installed. The transceiver transmit/receive voice, RF scope, AF scope, and CAT commands can be conveyed, and permit comfortable remote communication, effortless tuning and setting of various filters, scope functions, interference reduction functions etc. from a PC via the network.

Network Remote Control System LAN Unit SCU-LAN10



Supplied Accessories:
Connection Cable (13pin DIN plug) and USB (A-B) Cable

LAN Unit Specifications

General	
Supply Voltage	DC13.8V
Dimensions	W4.4" x H1.3" x D5.3" (111 x 31.5 x 135mm)
Weight	14.8oz (420g)
Operating Temperature Range	+32°F to +122°F (0 to +50°C)
LAN port	100BASE-TX/1000BASE-T

PC Control Software Operating Requirement

OS	Windows® 8.1 (32-bit/64-bit) (Except for Windows® RT) Windows® 10 (32-bit/64-bit)
CPU	CPU clock 3.2GHz or more, quad core or above
HDD	10 GB or more of available space
RAM	Windows® 8.1 (32-bit) 4GB or more Windows® 8.1 (64-bit) 4GB or more Windows® 10 (32-bit) 4GB or more Windows® 10 (64-bit) 4GB or more
Display Resolution	Display Resolution: 1366x768 or more 16-bit high color or more (32-bit true color is recommended)
Others	<ul style="list-style-type: none"> • LAN port • Audio interfaces • Speaker or Headphone • Microphone • Microsoft .NET Framework 4 or higher is installed (Enabled)

Rear Panel

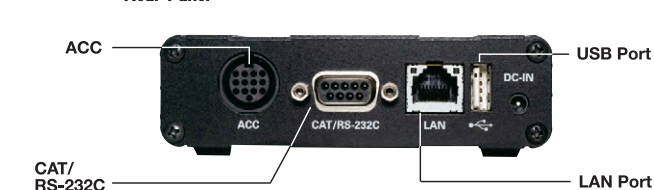

REAR PANEL	
ACC	DIN 13-pin
CAT/RS-232C	CAT/RS232C D-SUB 9-pin
LAN	RJ-45
USB	USB-A Type
DC-IN	DC10.5V max.800mA

LAN/Internet Connection	<ul style="list-style-type: none"> • LAN • Internet Connection (Download speed: at least 2 Mbps, Upload speed: at least 1.2 Mbps are recommended at the PC Side) • Communication is possible with the 4 ports among UDP (User Datagram Protocol) ports. * Address conversion function (NAPT, IP masquerade) is required when using Router. • Fixed global IP address or fixed domain name (for remote control using Internet line) When using the Internet, a fixed global IP address or fixed domain name is required for the network where the remote controlled radio is installed.
Ethernet Cable	Commercially available Straight Ethernet Cable (Category 5e or higher)

* Specifications and appearance of the PC remote control software and LAN unit are subject to change without notice or obligation.

* Advertisement image may be different from the actual unit.

FRONT PANEL / REAR PANEL

Front panel



- 1 USB Jacks**
USB (A type) keyboard and mouse connection terminals
- 2 KEY**
CW Key Jack
Manipulator and key connection terminal for electronic keyer (φ 6.3mm)
- 3 PHONES**
Headphone jack : stereo (φ 6.3mm)
* When headphones are connected, output from built-in speaker is muted
- 4 MIC**
Microphone Connector (8-pin)
- 5 SD card slot**
Use a commercially available SD card to save transceiver settings and memory contents. The SD card is also used to update the firmware

Rear panel

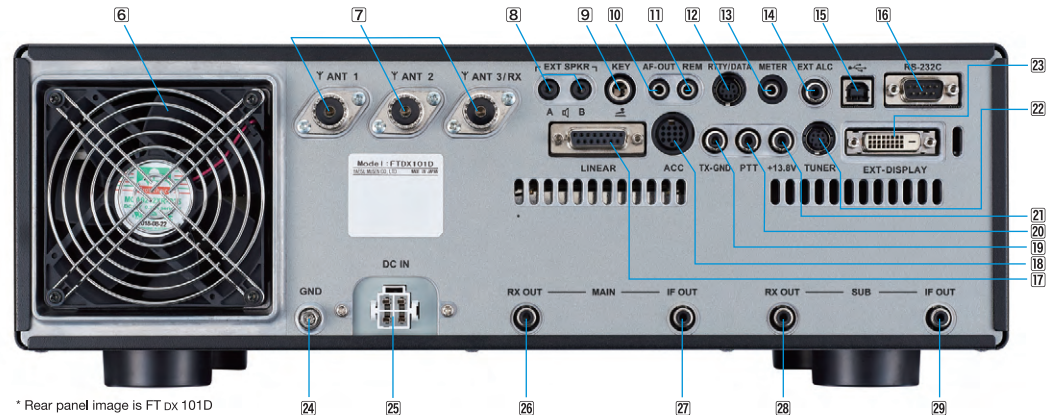

* Rear panel image is FT dx 101D

- 6 Cooling FAN**
- 7 ANT 1/2/3**
Three antenna terminals (M type)
* ANT3 can be set as receive only
- 8 EXT SPKR**
External speaker terminal
Mono jack (φ 3.5mm) to connect external speakers (4Ω to 8Ω)
- 9 KEY**
CW Key Jack
CW key & Electronic keyer connection terminal (φ 6.3mm)
- 10 AF-OUT**
Receive audio output terminal
Approximately 300mVp-p
- 11 REM**
Remote Control Keypad FH-2 connection terminal
- 12 RTTY / DATA**
Terminal unit for RTTY, TNC connection terminal for packet communication
- 13 METER**
Analog meter connection terminal
- 14 EXT ALC**
External ALC terminal
- 15 USB terminal**
USB connection terminal (Type B)
- 16 RS-232C**
RS-232C straight cable connection terminal (Remote control from Personal Computer)
- 17 LINEAR**
Terminal for linear amplifier connection
- 18 ACC**
External device connection terminal
- 19 TX-GND**
Transmit ground terminal for peripheral device control
- 20 PTT**
External PTT terminal
(5V open, 3mA closed-circuit)
- 21 +13.8V**
DC13.8V output for external devices (DC13.8V, 200mA MAX)
- 22 TUNER**
External antenna tuner connection terminal
- 23 EXT-DISPLAY**
External display connection terminal (DVI-D)
- 24 GND**
Earth ground terminal
- 25 DC IN**
DC13.8V power supply connection terminal (FT dx 101D)
External power supply (supplied) connection terminal (FT dx 101MP)
* Photo is FT dx 101D
- 26 RX OUT (MAIN)**
MAIN band RF output terminal for external receiver
- 27 IF OUT (MAIN)**
MAIN band IF signal output (9.005MHz)
- 28 RX OUT (SUB)**
SUB band RF signal output terminal for external receiver
- 29 IF OUT (SUB)**
SUB band IF signal output (8.900MHz)

OPTIONS

- VCT-101**
VC-Tune unit
FT DX 101D (for SUB Band)
* VC-Tune unit option
Please contact Yaesu about installation.

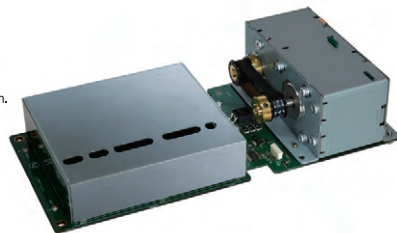

- CW / SSB Narrow Filters**
(CW Narrow Filter)
XF-128CN (MAIN)
9.005MHz / CW 300Hz
- (SSB Narrow Filter)**
XF-128SN (MAIN)
9.005MHz / SSB 1.2kHz
- XF-129CN (SUB)**
8.900MHz / CW 300Hz
- XF-129SN (SUB)**
8.900MHz / SSB 1.2kHz



* CW / SSB Narrow Filters option
Please contact Yaesu about installation.

MAIN ACCESSORIES

- SP-101**
High-Quality External Speaker
- Speaker diameter: φ 100mm
 - Maximum input: 7W
 - Impedance: 8Ω
 - Dimensions (W x H x D): (approx.) 6.30" x 5.12" x 12.68" (160 x 130 x 322mm)
 - Weight (approx.): 4.41lbs (2kg)



- M-1**
Reference microphone
- Dual microphone configuration
 - TBC (Treble Boost Cowling) produces a unique tonal texture
 - Long stroke Smooth Operating PTT key
 - High visibility ON AIR LED
 - Nine-band graphic equalizer for each microphone element
 - Large display (featuring anti-reflective AR coating)
 - Built-in record and playback feature



- M-100**
Dual element microphone
- Dual microphone configuration
 - TBC (Treble Boost Cowling) produces a unique tonal texture
 - Long stroke Smooth Operating PTT key
 - High visibility ON AIR LED
 - Built-in one-click Low-Cut and High-Cut filters



ACCESSORIES



- SCU-LAN10**
Network Remote Control System LAN unit (External type)



- FH-2**
Remote Control Keypad



- M-70**
Desktop microphone
- Long stroke Smooth Operating PTT key
 - Built-in Low-Cut and High-Cut filters



- SSM-75G**
Hand microphone (Supplied accessory)



- YH-77STA**
Lightweight Stereo Headphone



- FC-40**
Long wire compatible External auto antenna tuner (Support for up to 100W input)

FT DX 101 Series Standard Equipment

	FTDX101MP	FTDX101D
Transmitter Power Output	200W	100W
Supply Voltage	AC100V/AC200V External Power Supply with Speaker FPS-101 Included Built into External Power Supply FPS-101 (Supplied)	DC13.8V DC Power Cable Included Option (SP-101)
External Speaker	Equipped	Equipped
VC-Tune Unit (MAIN)	Equipped	Option (VCT-101D)
VC-Tune Unit (SUB)	Equipped	Equipped (MAIN and SUB)
CW Filter (600Hz)	Equipped (MAIN and SUB)	Option
CW Filter (300Hz)	Equipped (MAIN: 9.005MHz) Option (SUB: 8.900MHz)	Equipped (MAIN and SUB)
SSB Filter (3kHz)	Equipped (MAIN and SUB)	Equipped (MAIN and SUB)
SSB Filter (1.2kHz)	Option (MAIN: 9.005MHz, SUB: 8.900MHz)	Option (MAIN: 9.005MHz, SUB: 8.900MHz)
AM Filter (12kHz)	Equipped (MAIN and SUB)	Equipped (MAIN and SUB)

SPECIFICATIONS

General	
Tx Frequency Ranges	1.8MHz band - 50MHz band (Amateur bands only) 70MHz - 70.5MHz (UK Amateur bands only)
Rx Frequency Range	30kHz - 75MHz (operating) 1.8MHz - 29.699999MHz (Specified performance, Amateur bands only) 50MHz - 53.999999MHz (Specified performance, Amateur bands only) 70MHz - 70.499999MHz (Specified performance, UK Amateur bands only)
Emission Modes	A1A (CW), A3E (AM), J3E (LSB/USB), F3E (FM), F1B (RTTY), G1B (PSK)
Frequency Steps	1/5/10Hz (SSB, CW), 10/100Hz (AM, FM)
Antenna Impedance	50Ω, unbalanced (Antenna Tuner OFF) 16.7 - 150Ω, unbalanced (Tuner ON, 1.8MHz - 29.7MHz Amateur bands) 25 - 100Ω, unbalanced (Tuner ON, 50MHz Amateur band)
Operating Temperature Range	+32°F to +122°F (0°C to +50°C)
Frequency Stability	±0.1ppm (after 1 minute @ +14°F to +140°F [-10°C to +60°C])
Supply Voltage	AC100V/200V (FTDX101MP) DC13.8V ±10% (FTDX101D)
Power Consumption (Approx.)	Rx (no signal) 100VA (FTDX101MP), 3.5A (FTDX101D) Rx (signal present) 120VA (FTDX101MP), 4.0A (FTDX101D) Tx 720VA (FTDX101MP:200W) Tx 23A (FTDX101D: 100W)
Dimensions (WxHxD)	16.6" x 5.1" x 12.7" (420 x 130 x 322mm)
Weight (Approx.)	31.5 lbs (14.3kg): FTDX101MP, 26.5 lbs (12kg): FTDX101D

Transmitter	
Power Output	FTDX101MP: 200W (CW, LSB, USB, FM, RTTY, PKT), 50W (AM) FTDX101D: 100W (CW, LSB, USB, FM, RTTY, PKT), 25W (AM)
Modulation Types	J3E (SSB): Balanced A3E (AM): Low-Level (Early Stage) F3E (FM): Variable Reactance
Maximum FM Deviation	±5.0kHz / ±2.5kHz (Narrow)
Harmonic Radiation	Better than -50dB (1.8MHz - 29.7MHz Amateur bands) Better than -66dB (50MHz Amateur band: 200W) Better than -63dB (50MHz Amateur band: 100W)
SSB Carrier Suppression	At least 60dB below peak output
Undesired Sideband Suppression	At least 60dB below peak output

Receiver	
Bandwidth	3kHz (LSB/USB), 500Hz (CW) 6kHz (AM), 16kHz (FM)
Audio Response (SSB)	Not more than -8dB from 300 to 2700Hz
Microphone Impedance	600Ω (200 to 10kΩ)

Receiver			
Circuit Type	Double Superheterodyne		
Intermediate Frequencies	1st IF 9.005MHz (MAIN), 8.900MHz (SUB) 2nd IF 24kHz (MAIN/SUB)		
Sensitivity (TYP)	SSB/CW (BW: 2.4kHz/10dB S+N/N) 1.8MHz - 30MHz 0.16μV (AMP2 "ON") 50MHz - 54MHz 0.125μV (AMP2 "ON") 70MHz - 70.5MHz 0.16μV (AMP2 "ON") AM (BW: 6kHz/10dB S+N/N, 30% modulation @400Hz) 0.5MHz - 1.8MHz 6.3μV 1.8MHz - 30MHz 2μV (AMP2 "ON") 50MHz - 54MHz 1μV (AMP2 "ON") 70MHz - 70.5MHz 2μV (AMP2 "ON") FM (BW: 12kHz, 12dB SINAD) 28MHz - 30MHz 0.25μV (AMP2 "ON") 50MHz - 54MHz 0.2μV (AMP2 "ON") 70MHz - 70.5MHz 0.25μV (AMP2 "ON")		
Selectivity (WIDTH: Center)	Mode	-6dB	-60dB
	CW (BW=0.5kHz)	0.5kHz or better	0.75kHz or less
	SSB (BW=2.4kHz)	2.4kHz or better	3.6kHz or less
	AM (BW=6kHz)	6kHz or better	15kHz or less
	FM (BW=12kHz)	12kHz or better	25kHz or less
IF Rejection	60dB or better (1.8MHz - 28MHz Amateur bands, VC-tune "ON") 60dB or better (50MHz Amateur bands)		
Image Rejection	70dB or better (1.8MHz - 28MHz Amateur bands) 60dB or better (50MHz - 54MHz Amateur bands)		
Maximum Audio Output	2.5W into 4Ω with 10% THD		
Audio Output Impedance	4 to 16Ω (4Ω: nominal)		
Conducted Radiation	Less than 4nW		

* Specifications are subject to change, in the interest of technical improvement, without notice or obligation, and are guaranteed only within the amateur bands.

About this brochure: We have made this brochure as comprehensive and factual as possible. We reserve the right, however, to make changes at any time in equipment, optional accessories, specifications, model numbers, and availability. Precise frequency range may be different in some countries. Some accessories shown herein may not be available in some countries. Some information may have been updated since the time of printing; please check with your Authorized Yaesu Dealer for complete details.

YAESU
The radio

— **YAESU MUSEN CO., LTD.** <http://www.yaesu.com/jp> —

Tennozu Parkside Building
2-5-8 Higashi-Shinagawa, Shinagawa-ku, Tokyo 140-0002, Japan

— **YAESU USA** <http://www.yaesu.com> —

US Headquarters 6125 Phyllis Drive, Cypress, CA 90630, U.S.A.

— **YAESU UK** <http://www.yaesu.co.uk> —

Unit 12, Sun Valley Business Park, Winnall Close
Winchester, Hampshire, SO23 0LB, U.K.

