

YAESU

The radio

FT2DR/DE

Operating Manual

144/430 MHz
DIGITAL/ANALOG
TRANSCIVER

C4FM/FM



Before Using the Transceiver

Preparation

Basic Operation

Repeater Operation

Using the Memory

Scanning Function

Digital Group Monitor Function

Using the APRS Functions

Using the WIRES-X Functions

Using the GPS Function

Convenient Functions

Communicating with a
Specific Remote Station

Customize Menu Settings for
Individual Use (Set Mode)

Functions to Use a Necessary

Appendix

Before Using the Transceiver

Table of Contents

Before Using the Transceiver	2	Miscellaneous Settings.....	43
Introduction.....	6	Setting Clock Time.....	43
Features of the FT2DR/DE.....	6	Muting Audio.....	44
Using the Touch Screen.....	7	Changing the Transmission Power Level.....	46
How to Read This Manual.....	7	Adjusting the Squelch Level.....	47
Checking the Supplied Items.....	8	Setting the Frequency Step.....	47
Safety Precautions (Be Sure to Read).....	9	Changing the Mode.....	48
Names and Functions of Controls.....	14	Locking Keys and Switches.....	49
Transceiver.....	14	Attenuator (ATT) Function.....	50
Touch Screen Display.....	15	Restoring to Defaults (All Reset).....	51
Entering Letters.....	19	Repeater Operation	52
Preparation	20	Repeater Operation.....	52
Attaching the Supplied Accessories.....	20	Communicating Via the Repeater.....	52
Installing the Antenna.....	20	Repeater Shift.....	53
Attaching the Accessory Protective Cap/Belt Clip.....	20	Automatic Repeater Shift (ARS).....	53
Attaching the Protective Cap.....	20	Tone Calling (1750 Hz).....	53
Attaching the Belt Clip.....	20	Using the Memory	54
Attaching a Hand Strap.....	21	A Wide Variety of Memory Functions.....	54
Preparing the Battery Pack/External Power Supply.....	22	Registering to Memory Channel.....	55
Installing/Removing the Battery Pack.....	22	Split Memory.....	56
Installing the Battery Pack.....	22	Recalling a Memory Channel.....	57
Removing the Battery Pack.....	22	Recalling the Home Channels.....	57
Charging the Battery Pack.....	22	Returning to the Previous Frequency.....	58
How to Use the Battery Case (FBA-39).....	25	Changing the Home Channel Frequency.....	58
Connecting an External Power Supply for Use in Vehicle.....	26	Clearing Memories.....	59
Connecting to an External Power Supply Using a Power Cable.....	27	Restoring the Cleared Memories.....	59
Using a microSD Memory Card.....	29	Using Memory Tag.....	59
Usable microSD Memory Cards.....	29	Assigning a Name to a Memory Channel.....	60
Cautions when Using a microSD Memory Card.....	29	Displaying the Memory Tag.....	61
Mounting and Dismounting microSD Memory Card.....	29	Using Memory Bank.....	62
Formatting a microSD Memory Card.....	31	Registering to Memory Banks.....	62
Basic Operation	32	Recalling Memory Bank.....	63
Performing Communication.....	32	Canceling Memory Channel Registration in Memory Bank.....	63
Turning on the Transceiver.....	32	Assigning Name to Memory Bank.....	64
Adjusting the Volume Level.....	34	Convenient Preset Receiver Memory Channels.....	65
Toggling the Operating Band.....	34	Registering Preset Receiver Memory Channels into Memory Banks.....	66
Selecting a Frequency Band.....	37	Recalling Preset Receiver Memory Channel to Listen to the Weather Broadcast.....	66
Tuning to a Frequency.....	38	Recalling Preset Receiver Memory Channel to Listen to the International VHF (Marine) Radio.....	67
Selecting the Communication Mode.....	39	Recalling Preset Receiver Memory Channels to Listen to World Wide Broadcasts.....	68
Transmitting/Receiving Signals.....	40	Worldwide short wave broadcast.....	69
Listening to the Radio.....	42	Scanning Function	71
Listening to the AM/FM Radio.....	42	VFO Scan.....	71
		Canceling Scanning.....	72

Skipping Frequencies You Do Not Want to Scan (Skip Search Memory)	72	Using the Back Track Function	94
Specifying the Frequencies You Do Not Want to Scan	73	Description of the BACK TRACK Function Screen.....	95
Deleting the Frequency Registered to the Skip Search Memory Channel	73	Convenient Functions.....	96
Setting the Receive Operation When Scanning Stops	74	Dual Receive (DW) Function.....	96
Memory Channel Scanning	76	VFO Dual Receive	
Specifying Skip/Selected Memory Channels	77	VFO mode → Priority memory channel	97
Scanning Only the Specified Memory Channels	78	Memory Channel Dual Receive	
Scanning the Memory Bank.....	79	Memory channel → Priority memory channel.....	98
Memory Bank Link Scanning	79	Home Channel Dual Receive	
Programmable Memory Channel Scan (PMS)	81	Home channel → Priority memory channel....	98
Registering to the Programmable Memory Channels	81	AF-DUAL Receive Function (Receiving Signals on Other Frequency Channels While Listening to Broadcast Radio).....	100
Performing Programmable Memory Channel Scan	81	Listening to a Radio Broadcast Using the AF-DUAL Receive Function.....	100
Digital Group Monitor Function		Setting the Resumption Time of Radio Reception.....	101
Using the Digital GM Function	83	Using the DTMF Function.....	103
What is the GM function?	83	Setting the DTMF Memory.....	103
Standard Operation of the GM Function.....	83	Transmitting the Registered DTMF Code	104
Displaying All Stations (up to 24 Stations) Operating with the GM Function	83	Manually Transmitting the DTMF Code	105
Registering IDs of Friends in a Group and Displaying Only Registered GM Users	84	Spectrum Analyzer with Signal Strength Graph	
Deactivating the GM Function.....	84	Band Scope Function	106
Using the APRS / WIRES-X Functions	85	Taking Picture Using the Optional Camera-Mounted Speaker Microphone Snapshot Function	107
The APRS (Automatic Packet Reporting System) Function.....	85	Viewing the Saved Image	108
What is the WIRES-X Function?	85	Transmitting the Saved Image to Other Transceivers	108
Using the GPS Function	86	Communicating with a Specific Remote Station	109
The GPS Function.....	86	Using the Tone Squelch Function.....	109
Activating the GPS Function.....	86	Selecting the Squelch Type	109
Method of Positioning by GPS.....	88	Setting the Tone Frequency	110
Displaying Position Information of Remote Stations in Digital Mode	88	Searching for the CTCSS Tone transmitted by the Remote Station	111
Saving GPS Information (GPS Log Function).....	89	Setting the DCS Code.....	112
Checking Tracks on Your PC	90	Searching for the DCS Code Used by the Remote Station	112
GPS Screen Information and Operation.....	91	Notification of a Call from a Remote Station by Vibration	113
Displaying the GPS Information.....	91	Selecting the Vibrator Operation Mode	114
Smart Navigation Function	93	Notification of a Call from a Remote Station by the Bell Function	114
Real-Time Navigation Function.....	93	Changing the Number of Times the Bell Rings	115
Backtrack Function	93	Calling Only a Specific Station	
Registering Your Current Position (Departure Point) (up to 3 Positions can Be Registered)	93	New Pager Function	116
		Flow of Operation to Use the Pager Function.....	116

Table of Contents

Setting the Code for Your Station	116	Set Mode: SIGNALING Menu Operations	138
Activating the New Pager Function.....	117	Notification of a Call from a Remote Station	
Calling a Specific Station	117	by the Bell	138
Being Called by the Remote Station		Selecting a DCS Code.....	138
(Standby Operation).....	118	Transmitting and Receiving a DCS Code with an	
Customize Menu Settings for Individual Use		Inverted Phase DCS INVERSION Function.....	138
(Set Mode)	119	Setting the Transmission Method of the DTMF	
Using Set Mode.....	119	Code	138
Set Mode Operation.....	119	Setting the DTMF Code	139
Resetting the All Set Mode Settings.....	120	Calling Only a Specific Station (New Pager	
Tables of Set Mode Operations	121	Function).....	139
Set Mode: DISPLAY Menu Operations.....	128	Enabling No-communication Squelch Function	
Setting What to Display Using the Smart		PR FREQUENCY Function.....	139
Navigation Function	128	Adjusting the Squelch Level SQL LEVEL	
Setting the Compass Display.....	128	Function	139
Setting the Search Channels for the BAND		Setting the Squelch to Activate at a Specified	
SCOPE Function.....	128	Signal Strength S-Meter Squelch Function.....	140
Changing the Lighting Condition.....	129	Setting the Squelch Type for Transmit and	
Selecting the Display Language	129	Receive SQL EXPANSION Function	141
Adjusting the LCD Contrast Level.....	129	Setting the Type of Squelch.....	141
Adjusting the LCD Backlight and Key Button		Selecting a CTCSS Tone Frequency	141
Light Brightness Level.....	130	Setting the Sound and Speed During Tone	
Changing the Opening Message Displayed		Search Tone Search Function.....	141
Immediately after Power-on	130	Set Mode: SCAN Menu Operations.....	142
Displaying the Battery Voltage.....	130	Setting the Surveillance Interval Time for Priority	
Changing the Display Pattern of the S-Meter	131	Channels DW INTERVAL TIME Function	142
Displaying the Software Version	131	Setting the Illumination On/Off When Scanning	
Set Mode: TX/RX Menu Operations.....	132	Stops LAMP Function	142
Reducing Receiver Sensitivity		Setting the Time to Resume Scanning SCAN	
Attenuator (ATT) Function.....	132	RE-START Function.....	142
Setting the Transmit Modulation Level.....	132	Selecting a Receive Operation When Scanning	
Switching the Receive Mode.....	133	Stops.....	143
Setting the Squelch Type for the Digital Mode... 133		Setting the Scanning Range	143
Setting the Pop-up Time of the Remote Station		Set Mode: GM Menu Operations.....	144
Information	133	Set Mode: WIRES-X Menu Operations	144
Displaying Your Location in Digital Mode.....	134	Set Mode: CONFIG Menu Operations.....	145
Setting the Standby Beep	134	Turn Power Off Automatically	
Adjusting the Microphone Sensitivity		Auto Power-Off Function.....	145
Microphone Gain.....	134	Preventing Accidental Transmission Busy	
Muting Audio	135	Channel Lockout (BCLO) Function.....	145
Simultaneous Radio Broadcast Reception	135	Setting the Key Operation Confirmation	
Set Mode: MEMORY Menu Operations	136	Sound.....	146
Setting Memory Bank Link.....	136	Turning off the BUSY Indicator	146
Assigning Name to Memory Bank.....	136	Setting the Clock Shift for the Micro Computer	
Assigning Name to Memory Channel	136	Clock Type Function	147
Prohibiting Registration to a Memory Channel		Setting a Time Interval for Saving GPS Position	
Memory Channel Protect Function	137	Information	147
Setting Memory Skip Function	137	Permitting/Prohibiting Transfer of Home Channel	
Setting the Memory Channels Used for		Frequency to VFO.....	147
Registration.....	137	Using the LED Light.....	148
		Setting the LOCK Function	148

Setting the Operation of the  Key	148
Turning on/off the Transceiver at the Specified Time Timer Function	149
Password Function	149
Setting the PTT Delay Time PTT DELAY Function	150
Setting the ARS Function RPT ARS Function....	150
Setting the Repeater Shift Direction RPT SHIFT Function	150
Setting the frequency offset for Repeater Shift RPT SHIFT FREQ Function.....	151
Disabling Receiver While No Signal Is Received Receiver Battery Save Function	151
Changing the Frequency Step Manually.....	151
Setting Clock Time.....	151
Limit the time of a continuous transmission (TOT Function).....	152
Setting the Frequency Selection Range for Operation in VFO Mode VFO MODE Function	152
Notifying a Call From a Remote Station by Vibration.....	152
Swapping the Dial Knob Functions.....	152
Set Mode: APRS Menu Operations.....	153
Set Mode: SD CARD Menu Operations	154
Saving/Loading Data to/from microSD Memory Card	154
Saving/Loading Memory Channel Information to/ from microSD Memory Card	155
Saving/Loading GROUP ID Information to/from a microSD Memory Card	155
Formatting a microSD Memory Card	156
Set Mode: OPTION Menu Operations.....	157
Setting the Optional Microphone With Camera for Use	157
Set Mode: CALLSIGN Menu Operations.....	158
Functions to Use as Necessary	159
Using the Transceiver for Packet Communication.....	159
Clone Operation	160
Connecting an External Device	161
Connecting to a PC.....	161
Connecting to an External Device.....	162
Connection Cables.....	162
Data Cable (CT-170)	162
Data Output Cable (CT-176)	162
Appendix	163
Optional Parts.....	163
If you suspect malfunction Check the following items before requesting a repair.....	164
The transceiver does not turn on.	164
There is no sound.	164
There is no transmission of radio waves.....	164
The keys or DIAL does not respond.....	164
Index.....	166
Specifications	168

Features of the FT2DR/DE

- Digital communication (C4FM (Quaternary FSK), FDMA system)..... 39
- Equipped with AMS (Automatic Mode Select) Function..... 39
Automatically selects between 4 modes of transmission according to the signal being received.
- External power supply connection 15
- Simultaneous reception on two different bands, or within the same band (V+V/U+U) 34, 36
- Independent switching keys for A-band and B-band and TX/BUSY display 36
- Wide-band reception over the range of 500 kHz to 999.900 MHz 36
- Waterproof design equivalent to IPX5, which protects the transceiver from rain and splashes..... 13
- Large 160×160 dot LCD screen and touch panel 15
- WIRES-X connection support See WIRES-X instruction manual*
- Equipped with GM function See GM function instruction manual*
- Large-capacity 1266ch with 24 memory banks (maximum of 100 channels can be saved on each bank)..... 54
- Display memory tags comprised of up to 16 one-byte characters 59
- Convenient reception of preset receiver memory channels..... 65
By selecting preset frequencies, you can receive shortwave broadcast, and international VHF radio stations with ease.
- A wide variety of scan functions 71
- Built-in GPS unit allowing display of your current location and heading information 86
- Ready for APRS® communication using the world standard 1200 / 9600bps AX25 modem (B-band only) See APRS instruction manual*
- High-resolution band scope function to display ± 35 channels 106
- Equipped with the smart navigation function 93
- A variety of individual selective calling functions; such as tone squelch (CTCSS) and DCS functions 109
- Vibrator to alert you of signal reception, in addition to the audible bell..... 113
- New pager function for calling only specific stations..... 116
- LED Backlight for easy viewing of the LCD outdoors 147
- Battery save function to extend battery operating time 46
- Data terminal for communication with external equipment and firmware updates... 162
- Compatible with microSD memory cards 29
- Snapshot function (an optional camera microphone MH-85A11U is required) 107

* WIRES-X, GM function and APRS instruction manuals are not included in the product package.

They are available and may be downloaded from the Yaesu.com website.

Using the Touch Screen

• Caution when Using the Touch Screen

Observe the following precautions when using the touch screen. Failing to do so may result in malfunction or damage.

- Operate the touch screen with your fingers. Do not operate with any pointed objects including your fingernail or pen.
- Do not apply any excessive force to the touch screen.
- Do not scrub or scratch on the touch screen when cleaning it.

• Restrictions on touch operations

- The touch screen does not respond to any of the flicking and pinching-in/out operations.
- Due to the characteristics of the LCD, when the ambient temperature is low, the touch screen may respond slowly.

• Touch Screen Upkeep

- After turning off the transceiver, wipe the touch screen with a soft dry cloth.
- Do not use water, chemical agents or mild detergents.

How to Read This Manual

Common explanatory expressions used in this manual are as follows:

Press  Indicates to simply press a key or switch.

Press and hold  for over one second..... Indicates to press a key or switch for over one second.

Touch **[F MW]** Indicates briefly touching the screen.

Touch **[F MW]** for over one second Indicates touching the screen for over one second.

The following notations are also used in this manual.

Caution



...Explains caution to observe during operation.

Tip

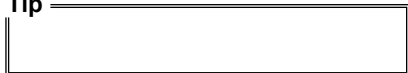

...Explains operating suggestions or useful tips.

Checking the Supplied Items

Transceiver

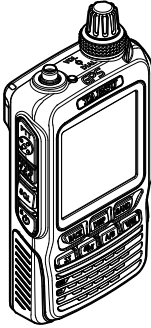

Antenna

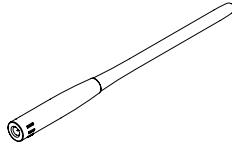

Long life
lithium-ion battery pack
(SBR-14LI: 7.2V,
2,200 mAh)

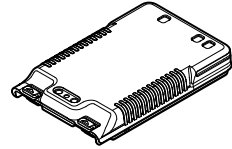

Belt clip

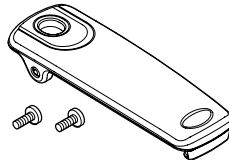

Battery charger
PA-48B/C/F/U* or SAD-14B

* "B" suffix is for use with 120 VAC (Type-A plug), "C" suffix is for use with 230-240 VAC (Type-C plug), "F" suffix is for use with 220 VAC, and "U" suffix is for use with 230 VAC (Type-BF plug).

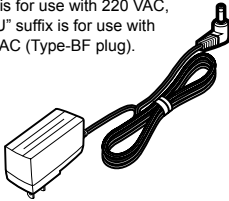

USB cable

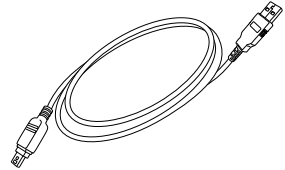

Battery pack
protective cap



- Quick Manual
- Operating Manual (this manual)
- Warranty Card

Cautions

- Ensure that the name of the dealer from which you purchased the transceiver and the date of purchase are indicated on the warranty card.
- If any item is missing, contact the dealer from which you purchased the transceiver.

Safety Precautions (Be Sure to Read)

Be sure to read the safety precautions to use this product safely.

Yaesu is not liable for failures and other problems caused due to misuse or use of this product by you or a third party. Also, Yaesu is not liable for damages caused through use of this product by you or a third party except in the case where ordered to pay for damages under the laws.

Types and Meanings of Symbols



DANGER

Indicates an imminently hazardous situation which, if not avoided, could result in death or serious injury.



WARNING

Indicates a potentially hazardous situation which, if not avoided, could result in death or serious injury.



CAUTION

Indicates a potentially hazardous situation which, if not avoided, may result in minor or moderate injury or only property damage.

Types and Meanings of Legends



Indicates a prohibited action, not to be done in order to use this product safely. For example,  indicates that the product should not be disassembled.



Indicates a required action, to be done in order to use this product safely. For example,  indicates that the power plug should be removed.



DANGER

 **Do not use this product in “an area where use of it is prohibited”, e.g., inside the hospital, airplane, or train.”**

This product can affect electronic or medical devices.

 **Do not use this product while riding a bicycle or driving a car. Accidents can result.**

Be sure to stop the bicycle or car at a safe place before using this product.

 **Those who are carrying a medical device such as a cardiac pacemaker should not perform transmission near the device. When transmitting, use an external antenna and keep as far as possible away from the external antenna.**

The radio wave emitted by the transmitter can cause the medical device to malfunction and result in an accident.



Do not use this product or the battery charger in a place where inflammable gas is generated.

A fire or explosion can occur.

Safety Precautions (Be Sure to Read)



Do not perform transmission in a crowded place for the safety of persons using a medical device such as a cardiac pacemaker.

The radio wave emitted from this product can cause the medical device to malfunction and result in an accident.



Do not touch any material leaking from the battery pack with bare hands.

The chemical that has stuck to your skin or entered your eye can cause chemical burns. In such a case, consult the doctor immediately.



Do not solder or short-circuit the terminal of the battery pack.

A fire, leak, overheating, explosion, or ignition can result.

Do not carry the battery pack together with a necklace, hair pin, or small metal objects. A short circuit can result.



If it starts thundering when the external antenna is used, immediately turn off this product and disconnect the external antenna from it.

A fire, electrical shock, or damage may result.



WARNING



Do not power this transceiver with a voltage other than the specified power supply voltage.

A fire, electric shock, or damage may result.



Do not use the battery pack for any model other than the specified transceiver.

A fire, leak, overheating, explosion, or ignition can result.



This product has a waterproof structure and conforms to "IPX5" when the included antenna and battery pack are installed and rubber caps are securely attached to the MIC/SP jack, EXTDC IN jack, DATA terminal, and micro SD slot. If this transceiver gets wet, wipe it with a dry cloth, etc. do not leave it exposed to the moisture.

Leaving this product in a wet condition can degrade its performance, shorten its life, or cause a failure or electrical shock.



Do not make very long transmissions.

The main body of the transceiver may overheat, resulting in a failure or burns.



Do not disassemble or make any alteration to this product.

An injury, electric shock, or failure can result.



Do not handle the battery pack or charger with wet hands. Do not insert or remove the power plug with wet hands.

An injury, leak, fire, or failure can result.



If smoke or strange odor is emitted from the main body, battery pack, or battery charger, immediately turn the transceiver off; remove the battery pack, and remove the power plug from the outlet.

A fire, leak, overheating, damage, ignition, or failure can result. Contact the dealer from which you purchased this product or Yaesu Amateur Customer Support.



Do not use the battery pack which is externally damaged or deformed.

A fire, leak, heating, explosion, or ignition can result.



Do not use any battery charger which is not specified by Yaesu.

A fire or failure can result.



When transmitting, keep the transceiver at least 5.0 mm (3/16 inch) away from your body.

Use only the supplied antenna. Do not use modified or damaged antennas.

Keep the terminals of the battery pack clean.



If terminal contacts are dirty or corroded, a fire, leak, overheating, explosion, or ignition can result.

If charging of the battery pack cannot be completed within the specified charging time, immediately remove the power plug of the battery charger from the outlet.



A fire, leak, overheating, explosion, or ignition can result.



CAUTION

Do not dangle or throw this product by holding its antenna.



This product can hit and injure someone. In addition, doing so can result in a transceiver failure or damage.

Do not use transceiver in a crowded place.



The antenna can hit someone, resulting in a injury.

Do not place this transceiver in a place subject to direct sunlight or near a heater.



The transceiver can deform or discolor.

Do not place this transceiver in a humid or dusty place.



A fire or failure can result.

During transmission, keep the antenna as far from you as possible.



Long-time exposure to electromagnetic waves can have a negative impact on your health.

Do not clean the case with thinner or benzene.



Use a soft, dry cloth to clean the case.

If the transceiver is not being used for an extended period, turn it off and remove the battery pack for safety.



Do not drop, strike, or throw the transceiver.



A failure or damage may result.

Keep magnetic cards and video tape away from the transceiver.



The data recorded on cash cards or video tape can be erased.

Do not use the earpiece microphone, earphones, or headphones at an extremely high volume level.



Hearing impairment can result.

Keep this product out of reach of children.



An injury, etc. can result.

Install the hand strap and belt clip securely.



If they are installed improperly, the FT-2DR/DE may fall or drop, resulting in an injury or damage.

Do not place a heavy object on the power cord of the battery charger.



The battery cord can be damaged, resulting in a fire or electric shock.

Do not use the included battery charger to charge any battery pack which is not specified for use with the charger.



A fire can result.

Do not operate the transmitter near the TV or radio.



Radio disturbance can occur in the transceiver, the TV, or the radio.

Do not use any products other than the specified options and accessories.



A failure can result.

When the battery charger is not in use, remove its power plug from the outlet



Safety Precautions (Be Sure to Read)

Charge the battery pack within the temperature range from +5 °C to +35 °C (+41 °F to +95 °F).



Charging the battery pack outside this temperature range can cause leak, overheating, decrease in performance, or reduction in service life can result.

When unplugging the power cord of the battery charger, be sure to hold the power plug.



Pulling the power cord can damage it and cause a fire or electronic shock.



Before discarding the worn battery pack, affix tape or the like to its terminals.

Before using this transceiver in a hybrid or fuel-saving car, be sure to check with the automobile manufacturer regarding use of the transceiver in that car.



Noise generated by an onboard electrical device (inverter, etc.) can disrupt the normal operation of the transceiver.

About Waterproofing Feature Conforming to IPX5

When the included antenna and battery pack are installed and the MIC/SP jack, EXT DC IN jack, DATA terminal, and micro SD slot are securely covered with rubber caps, this product is moisture and splash resistant. To ensure continued waterproofing protection, be sure to check the following points before use.

○ **Check for damages, deterioration, and dirt.**

Antenna rubber, key switch rubber, MIC/SP jack, EXT DC IN jack, DATA terminal, micro SD slot rubber cap, and battery pack joint.

○ **Cleaning**

When this product is contaminated with seawater, sand, or dirt, rinse with fresh water, and then wipe with a dry cloth immediately.

○ **Recommended maintenance interval**

To insure continued water resistance and optimal performance, it is recommended that maintenance be performed annually, or when any damage or deterioration is found. Note that the maintenance service is subject to fees.

○ **Do not immerse this product in the following liquids:**

Sea, pool, hot spring, water containing soap, detergent, or bath additive, alcohol, or chemicals

○ **Do not leave this product for an extended time in the following places:**

Bathroom, kitchen, or humid place

○ **Other precautions**

Since this product is not totally waterproof, it cannot be immersed in water.

Names and Functions of Controls

Transceiver

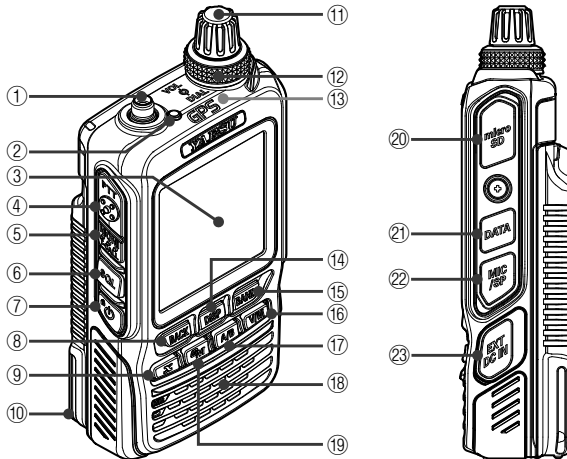

①	Antenna terminal (SMA)*
②	TX/BUSY LED Lights green (A-band) or blue (B-band) during receive and lights red during transmit.
③	Touch screen display Touch to set the frequency and various other settings.
④	[PTT] switch <ul style="list-style-type: none"> Press and hold to transmit, and release it to receive. Pressing [PTT] while in Set mode completes the Set mode function.
⑤	[MONI/T-CALL] switch USA/EXP version While is pressed: Squelch OFF European version While is pressed: T.CALL (1750 Hz)
⑥	[SQL] switch Press , rotate VOL: Squelch level adjustment
⑦	Power switch <ul style="list-style-type: none"> When the power is off, press and hold for over one second: Power on When the power is on, press and hold for over one second: Power off When the power is on, press : Engages and releases the key lock
⑧	[BACK] [BACK] key • Press to return to the previous screen.
⑨	[X] [X] key <ul style="list-style-type: none"> In normal mode, press to start WIRES-X. When WIRES-X is activated, press and hold for over one second to return to the normal mode.
⑩	Battery pack*

⑪	DIAL Rotate to change the frequency or select a memory channel.
⑫	VOL Adjusts volume. Turn clockwise to increase the audio level, and turn counterclockwise to decrease the audio level.
⑬	GPS antenna
⑭	[DISP] [DISP] key <ul style="list-style-type: none"> Pressing each time switches between the frequency display and the backtrack display. Press and hold for over one second to enter Set mode.
⑮	[BAND] [BAND] key • Pressing each time increases the frequency band.
⑯	[V/M] [V/M] key • Pressing each time switches between VFO mode and memory mode.
⑰	[A/B] [A/B] key (switching between operating bands) <ul style="list-style-type: none"> Pressing each time switches between A-band and B-band. Press and hold for over one second to switch between the Dual Band Receive mode and the Mono Band Receive mode.
⑱	Microphone
⑲	[GM] [GM] key Press to turn the GM function on/off.
⑳	microSD memory card slot* Open the cover and insert your microSD memory card.

- ⑪ **DATA terminal***
- To use the clone function, connect to another FT2DR/DE with an optional clone cable (CT-168).
 - When updating the firmware, connect to your PC using a USB cable.
 - * For instruction to update the firmware, access our website.
 - Connect the optional camera-equipped microphone (MH-85A11U) to this terminal.
 - Connect an external GPS to this terminal.
- ⑫ **MIC/SP jack***
- Connect a speaker microphone or earpiece microphone to this jack.
The waterproof protection cannot be attained when an external microphone is connected.
-  Do not connect any microphone which is not specified by Yaesu. A failure can result.







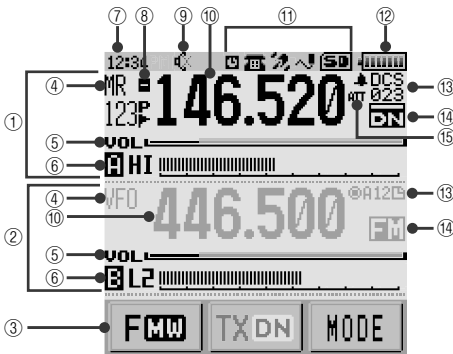

- ⑬ **EXT DC IN jack***
- When charging the battery pack, connect the battery charger (PA-48 or SAD-14B) to this jack.
 - In the USA/EXP market**, connect an external power supply adapter with a cigarette lighter plug (SDD-13) or an external power cable (E-DC-6) to this jack.
-  Do not connect any battery charger which is not specified by Yaesu. A failure can result.

*: When the included antenna and battery pack are installed and the MIC/SP jack, EXT DC IN jack, DATA terminal, and micro SD slot are securely covered with rubber caps, the FT2DR/DE meets the waterproofing performance conforming to IPX5 (See page 13).

Touch Screen Display



- ① This is the A-band display area.
- ② This is the B-band display area.
- ③ Displays touch keys.
- ④ Displays mode.
In VFO mode, "VFO" is displayed.
In Memory mode, "MR" and the channel number are displayed.
- ⑤ Display Bar indicates the volume level.
- ⑥ Displays the transmit output icon, the S meter and the PO meter levels.
S meter: Displays the received signal strength in 9 steps.
PO meter: Displays the transmit power level in 4 steps.
- H1: High power (5W)
 - L3: LOW 3 power (2.5W)
 - L2: LOW 2 power (1W)
 - L1: LOW 1 power (0.1W*1)

- ⑦ Displays the time.
- ⑧ Displays the frequency shift direction during repeater operation (see page 52).
-: Minus shift
+: Plus shift
S: Split operation
- ⑨  lights when the mute function is active (see page 44).
- ⑩ Displays the frequency.
- ⑪ Displays icon types.
 : Lights when Auto Power Off is active (see page 145).
 : Lights when DTMF function is enabled (see page 103).
 : Lights when GPS is acquired (see page 86).
 : Lights when GPS Log Function is enabled (see page 89).
 : Lights when a microSD memory card is inserted (see page 29).
- ⑫ The battery condition is displayed in 8 steps.
 : Full battery power
 : Battery is depleted. Charge battery.
 : (When blinking) Charge battery immediately.

*1: European version (VHF: 0.05W)

Names and Functions of Controls

- ⑬ Displays squelch type (see page 109)

TN: Lights when the tone encoder function is enabled.

TSQ: Lights when the tone squelch function is enabled.

DCS: Lights up when the DCS function is enabled.

RTN: Lights when the reverse tone function is enabled.

PR: Lights when the idle signal squelch function is enabled.

PAG: Lights when the pager is enabled.

DC: Lights when the transceiver is set to send the DCS code only during transmission.

T-D: Lights when the transceiver is set to send the CTCSS tone signal during transmit, and wait for the DCS code in receive mode.

D-T: Lights when the transceiver is set to send the DCS code during transmit, and wait for the CTCSS tone signal in receive mode.

Displays the APRS baud rate (B-band only)
(see APRS function Instruction manual).

- ⑭ Displays operation mode.

FM: FM (Analog) mode

: Auto mode (automatic switching among Analog AM, Analog FM, and Digital) *The display of the "FM" portion differs according to the selected mode.

DN: Wide digital mode (digital mode using C4FM modulation)

VW: Wide digital mode (high-quality digital communication)

- ⑮  appears when the bell function is active (see page 114).

• Dual Band Screen

A-band and B-band are displayed in a top-down fashion.

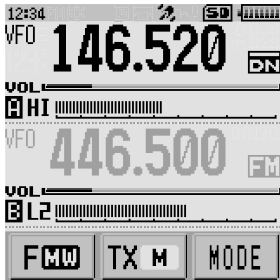

- Touching **[F MW]** displays the function menu screen.
- Touching **[TX M]** enables the communication mode to be fixed on the transmission side.
- Touching **[MODE]** each time switches the operation mode.

• Function Menu Screen

Touching **[F MW]** displays the function menu screen.



• Band Scope Screen

The band scope screen can be displayed by touching **[SCOPE]** from the function menu screen.

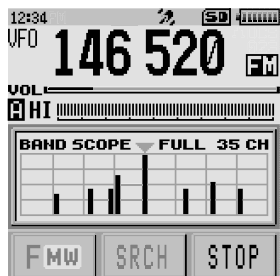

Reference You can change the number of band scope channels by pressing and holding the **[DISP]** key for over one second to enter Set mode, then select **[DISPLAY]** → **[3 BAND SCOPE]** to select the desired number of channels (17ch/35ch/71ch).

• BACKTRACK Screen

Pressing the **[DISP]** key displays the BACKTRACK screen.



- The compass setting is displayed to the upper left of the compass icon. “H-UP” indicates the vehicle direction of travel is shown at the top of the compass. “N-UP” is shown when the compass is set to always indicate North at the top. To change the compass setting, enter Set mode, then select **[DISPLAY]** → **[2 HEADING UP]**.
- Upon retrieval of the registered position information, the distance from the current position is displayed the upper right of the compass icon.
- Touching **[YR]** displays the position of the received station on the compass icon (only when the received signal carries the position information).
- Touching **[MY]** displays your station’s heading direction on the compass icon.
- Touching **[MEM]** switches to the registration mode to record.
- Touching **[★]** displays the position information registered with the “★” tag. Touching “★” while flashing, stores the position information displayed on the compass icon in the memory with a “★” tag.
- Touching **[L1]** displays the position information registered with the “L1” tag. Touching [L1] while flashing, the position information displayed on the compass icon is stored in the memory with an “L1” tag.
- Touching **[L2]** displays the position information registered with the “L2” tag. When touching **[L2]** while flashing, stores the position information displayed on the compass icon in the stored in the memory with an “L2” tag.

Entering Letters

The keyboard screen appears for inputting letters, numbers and symbols for your call sign or a memory channel tag.

• Number Input Screen



• Alphabet Input Screen



- Touch **[ABC]** to display the alphabet input screen.
- Touch **[A]** to display the alphabet (2 byte character) input screen.
- Touch the **[1]** key to display the numeric (2 byte character) keypad input screen.
- Touch the **[123]** key to display the numeric keypad input screen.
- Touch **[#%]** to display the symbol input screen.
- Touch **[#]** to display the symbol (2 byte character) input screen.
- Repeatedly touch the same key to advance in order through the characters assigned to the key. Lowercase letters are displayed, and then uppercase. For example, every time you touch **[abc]** key, it changes the characters as follows: a → b → c → A → B → C
- Touch **[←] [→]** to move the cursor to left/right in the text input area.

Attaching the Supplied Accessories

Installing the Antenna

- 1 Align the bottom side of the antenna with the antenna connector on the transceiver.

Caution Be sure to hold the thick base of the antenna when installing it

- 2 Turn the antenna clockwise until it is secured.

Cautions

- Do not hold or twist the upper part of the antenna when installing or removing it. To do so may break the conductors inside the antenna.
- Do not key the transmit without installing the antenna. The transmitter components may be damaged.
- When using an antenna other than the one supplied, or connecting to an external antenna, ensure that the SWR is adjusted to 1.5 or lower.

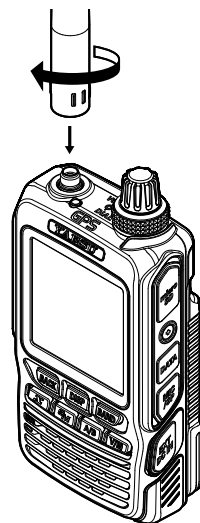

Attaching the Accessory Protective Cap/Belt Clip

Attaching the Protective Cap

If you do not use the belt clip, install the protective cap to cover the belt clip attaching screw holes on the battery pack.

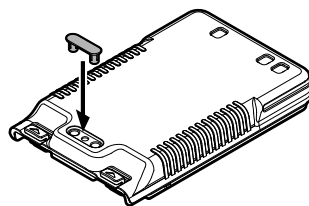

Attaching the Belt Clip

- 1 Turn the battery pack over.
- 2 Attach the belt clip to the battery pack using the supplied screws (two).

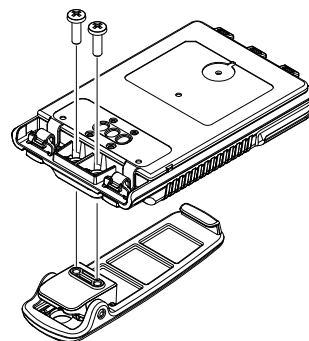

Cautions

- Be sure to use the supplied screws when attaching the belt clip. If any other screws are used, the belt clip cannot be secured firmly to the battery pack and the transceiver may drop off together with the battery pack; the transceiver and battery pack may fall off, causing injury, breakage and other damage.
- Be sure to attach the protective cap when the belt clip is not used.

Attaching a Hand Strap

If you attach a hand strap to the transceiver, insert its 1 mm diameter string through the strap hole of the transceiver and thread the strap through the loop to secure it to the transceiver.

* The hand strap is not supplied.

- 1 Remove the battery pack.
- 2 Attach the hand strap.

Caution

Use a hand strap which can withstand the weight of the transceiver. If you use a hand strap which is not strong enough, the hand strap can break and the transceiver may fall down, causing injury, breakage and other troubles.

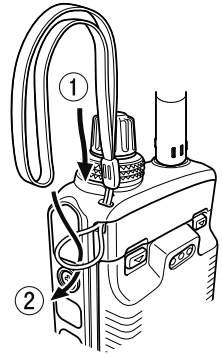

Preparing the Battery Pack/External Power Supply

Installing/Removing the Battery Pack

Installing the Battery Pack

- 1 Insert the bottom tabs of the battery pack in the slots on the back side lower part of the transceiver.
- 2 Push the battery in until the battery latches click securely.

Caution

Charge the battery pack before using the transceiver for the first time after purchase, or when it has not been used for a long period time.

Caution

Risk of explosion if battery is replaced by an incorrect typ. Dispose of used batteries according to the instructions.

Battery latches

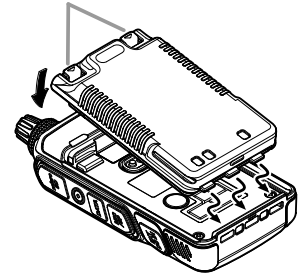

Removing the Battery Pack

- 1 While pressing down the latches, remove the battery pack.
Press the latches down in the direction of the arrows as shown in the illustration.

Caution

When releasing the battery latches, be careful not to hurt your fingers and nails.

Press down on the latches in the direction of the arrow.

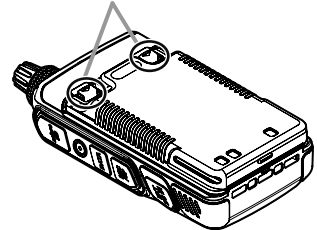

Charging the Battery Pack

Cautions

- The battery pack is rechargeable about 300 times. However, improper use such as overcharge or over-discharge can shorten its service life.
- The battery pack is a consumable item. Recharging the battery pack repeatedly will gradually reduce the charge capacity and duration of its use.
- If the transceiver is not used for a long period of time with the battery pack installed, deterioration of the battery pack can accelerate.
- If the transceiver is unused for a long period of time, be sure to store it with the battery pack removed. When the transceiver and battery are stored for an extended period, install the battery pack biannually and recharge the battery pack about 50% to prevent it from over-discharging.
- Storing the battery pack in a high-temperature environment can accelerate deterioration. Store the battery pack in a place where the ambient temperature is $-20\text{ }^{\circ}\text{C}$ to $+50\text{ }^{\circ}\text{C}$ ($-4\text{ }^{\circ}\text{F}$ to $+122\text{ }^{\circ}\text{F}$).
- Be careful not to drop or strongly impact the battery pack. It can break.

Tips

- The battery pack contains lithium-ion batteries that can be recharged for repeated use.
- The transceiver can be used with either of the following battery packs:
 - (1) Supplied battery pack: SBR-14LI (7.2 V, 2,200 mAh)
 - (2) Optional battery pack: FNB-101LI (7.4 V, 1,100 mAh)
- When the battery pack is recharged, its output voltage becomes higher (about 8 V) than the specified value (7.2 V). This is not a malfunction.

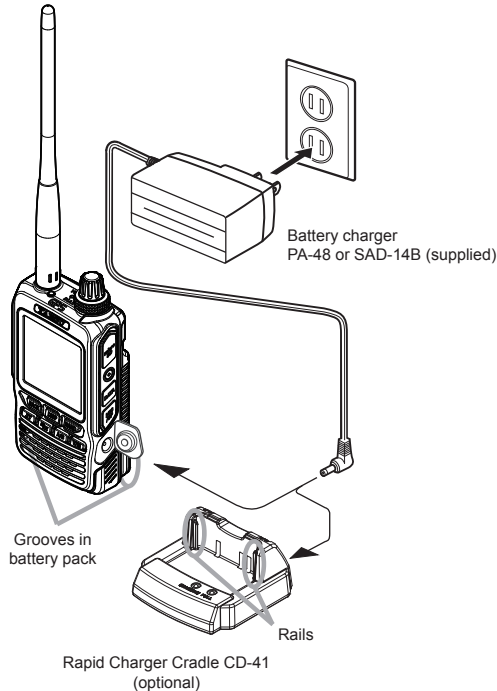

- 1 Install the battery pack.
- 2 Turn the transceiver off.
- 3 Insert the plug of the battery charger (PA-48 or SAD-14B) into the EXT DC IN jack of the transceiver.

Charging starts.

On the top part of the transceiver, the TX/BUSY LED lights red, and the display indicates "NOW CHARGING".

The charge level is indicated by a bar graph.

It takes about 9 hours to charge the SBR-14LI battery pack fully.

When charging is completed, the display will change to indicate "COMPLETE" and the lamp will light green.

Remark In the USA Version, the TX/BUSY LED is not lit when charging or when charging is complete. When the charge is complete, the transceiver turns off after 3 minutes.

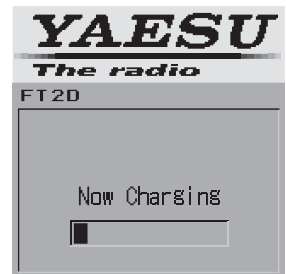

Preparing the Battery Pack/External Power Supply

Supplements

- It takes about 5 hours to charge the FNB-101LI (optional).
- The optional Rapid Charger Cradle (CD-41) requires about 5 hours to charge the supplied battery pack (about 2.5 hours to charge the optional battery pack FNB-101LI).

Place the battery pack on the CD-41 so that the rails of the CD-41 fit into the grooves on the battery pack.

When charging the battery pack using the CD-41, the LED on the CD-41 indicates the state of charging.

During charging: Glows red → Blinks fast → Blinks slowly

Completion of charging: Lights green

4 Remove the plug of the battery charger from the jack of the transceiver.

Cautions

- The supplied PA-48 or SAD-14B battery charger is not adequate to operate the transmit and receive while charging the battery pack.
- Charging may cause noise in a nearby TV or radio.
Charge the battery pack with the battery charger as far away as possible from a TV or radio.
- If “BATTERY NOT INSTALLED” appears on the LCD and the battery pack is not charged after a lapse of 11 or more hours, stop charging the battery pack immediately.
If the same message appears again, the battery pack is presumed to be at the end of its service life, or defective. In this case, replace the battery pack with a new one.
- While charging the battery pack, protect the transceiver from water.
- Charge the battery pack in a place where the ambient temperature is +5 °C to +35 °C (+41 °F to +95 °F).
- If the terminal or electrode of the battery case is dirty, this transceiver can malfunction due to poor contact, resulting in overheating or rupture. If the terminal or electrode gets dirty, clean it using a dry cloth or cotton swab.

Tips

- The battery charger may become hot during charging. This is not a malfunction.
- If  starts blinking, the battery pack charge is depleted. Charge it immediately.

Approximate Operating Time and Remaining Charge Level Indication

Approximate operating time for the transceiver with the fully charged battery pack or new AA alkaline batteries is as follows:

Band in Use Digital: OFF		Battery pack SBR-14LI	Battery pack FNB-101LI	Battery FBA-39
Amateur Band	144 MHz band	Approx. 12.0 hours	Approx. 6.0 hours	Approx. 14 hours
	430 MHz band	Approx. 11.0 hours	Approx. 5.5 hours	Approx. 13 hours
AM Broadcast Band		Approx. 25.0 hours	Approx. 13.0 hours	Approx. 16 hours
FM Broadcast Band		Approx. 25.0 hours	Approx. 13.0 hours	Approx. 16 hours
Band in Use Digital: ON		Battery pack SBR-14LI	Battery pack FNB-101LI	Battery FBA-39
Amateur Band	144 MHz band	Approx. 10 hours	Approx. 5.0 hours	Approx. 12.0 hours
	430 MHz band	Approx. 9 hours	Approx. 4.5 hours	Approx. 11.0 hours

Transmission 6 seconds: Reception 6 seconds (VOL Level 16): Stand By 48 seconds (SAVE1:5)

Remark Approximate hours are estimated assuming that the transceiver is operated under the following conditions. The operation time that this transceiver can be actually used varies depending on use conditions, ambient temperature, etc.

- When the GPS function is deactivated.
- LAMP MODE SAVE ON (always LAMP OFF)
- When the transceiver is repeatedly operated by high-power transmission for 6 seconds and reception for 6 seconds, and standby for 48 seconds with an amateur ham radio band selected.

How to Use the Battery Case (FBA-39)

The optional battery case (FBA-39) allows 3 AA Alkaline batteries to be used to power the FT2DR/DE transceiver.

Tip

When the battery case (FBA-39) is used, the power output level may be selected from:

Low Power (L1): 0.1 W

Low Power (L2): Approximately 0.8 W

Note that Low Power (L3) and High Power are not available.

1 Open the cover.

Lift up the lower right corner of the cover as indicated by the hand pointer in the illustration.

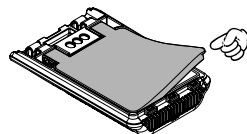

2 Place the alkaline batteries in the battery case.

Caution Use 3 alkaline batteries. Pay attention to polarities (+ and -) of the alkaline batteries.

3 Close the cover.

Push the four corners of the cover firmly to close it tightly.

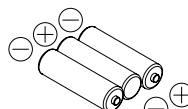

Tip

When the battery charge is low,  lights on the LCD. When the batteries are almost exhausted,  blinks on the LCD.

Cautions

- Lithium/Manganese batteries cannot be used with the FBA-39 battery case. Rechargeable AA batteries cannot be used, either.
- Do not mix new and old batteries. The service life of new batteries may decrease.
- If you do not use the transceiver for a long period, remove the batteries from the battery case.
- If the terminal or electrode of the battery case is dirty, the transceiver can malfunction due to poor contact, resulting in overheating or explosion. If the terminal or electrode gets dirty, clean it using a dry cloth or cotton swab.

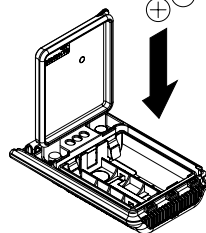

Connecting an External Power Supply for Use in Vehicle (USA/EXP version only)

The optional external power supply adapter with a cigarette lighter plug (SDD-13) allows the transceiver to be used in a vehicle.

- 1 Turn off the transceiver.
- 2 Insert the plug of the external power supply adapter with a cigarette lighter plug (SDD-13) in the EXT DC IN jack of the transceiver.
- 3 Insert the cigarette lighter plug of the external power supply adapter in the cigarette lighter socket of the vehicle.

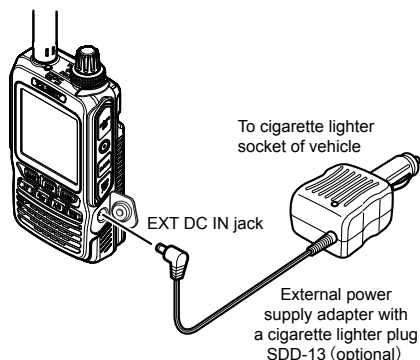

Cautions

- The SDD-13 is compatible with a 12 V DC cigarette lighter socket. Do not connect the SDD-13 to a 24 V DC cigarette lighter socket.
- Use the transceiver at the minimum required transmit power level to prevent overheating.
- Do not continue transmitting for a prolonged period of time. The transceiver may overheat, resulting in malfunction or burns.
- To operate the transceiver for 7 hours or longer, it is recommended that the battery pack be replaced with the optional battery case (FBA-39).
- Recharging the fully-charged battery pack repeatedly can shorten its service life. Be extremely careful not to continually recharge the battery when operating the transceiver using an external power supply.
- While charging the battery pack, protect the transceiver from water.
- Charge the battery pack in a place where the ambient temperature is +5 °C to +35 °C (+41 °F to +95 °F).
- If the terminal or electrode of the battery pack is dirty, the transceiver can malfunction due to poor contact, resulting in overheating or rupture. If the terminal or electrode gets dirty, clean it using a dry cloth or cotton swab.

Tips

- The SBR-14LI battery pack can be charged in approximately 9.0 hours using the external power supply (approximately 5 hours to charge the optional battery pack FNB-101LI). If the transceiver is turned on while the battery pack is charging, the charging time will increase slightly.
- Charging stops automatically when the battery pack has been fully charged.
- The external power supply can be used with the battery case installed.
- If the transceiver is connected to the external power supply with the transceiver turned off, "CONNECTED TO EXTERNAL POWER" appears on the LCD for about 20 seconds later "BATTERY NOT INSTALLED" appears.

Connecting to an External Power Supply Using a Power Cable (USA/EXP version only)

The optional power cable (E-DC-6) allows the transceiver to be connected to an external power supply.

- 1 Turn off the transceiver.
- 2 Connect the optional external power supply cable (E-DC-6) to an external power supply.

- Remarks**
- Connect the red/black wire or white/red wire to the positive (+) terminal of the external power supply and the black wire to the negative (-) terminal.
 - Set the voltage of the external power supply at 12 to 14 V.

- 3 Insert the plug of the external power supply into the EXT DC IN jack of the transceiver.

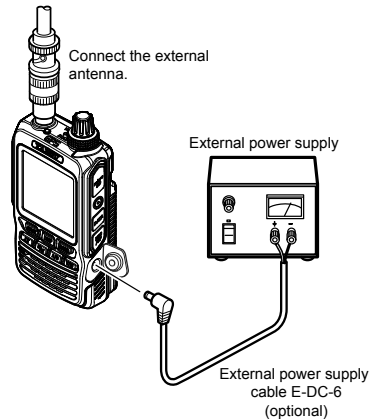

Cautions

- When using the transceiver with the external power supply cable (E-DC-6) connected to an external power supply, pay attention to the following:
 - The power supply voltage must be between 12 V and 14 V. If the voltage exceeds 16 V, malfunctions and damage to the electric circuits of the transceiver may result. Take extra care.
- Connect the red/black wire or white/black wire of the external power supply cable (E-DC-6) to the positive (+) terminal of the external power supply and the black wire to the negative (-) terminal.
- Use an external power supply having sufficient current capacity (3 A or more).
- If the transceiver is used with the supplied antenna connected, the transmit RF may interfere with the external power supply, resulting in malfunction or failure. When using an external power supply, remove the supplied antenna and connect an external antenna. Place the external power supply sufficiently away from the transceiver to avoid RF interference.
- Use the transceiver at the minimum required transmission power level to prevent overheating.
- Do not continue transmitting for a prolonged period. The transceiver may overheat, resulting in malfunction or a burn injury.
- To operate the transceiver for 7 hours or longer, it is recommended that the battery pack be replaced with the optional battery case (FBA-39).
- Recharging the fully-charged battery pack repeatedly can shorten its service life. Be extremely careful not to continually recharge the battery when operating the transceiver using an external power supply.
- While charging the battery pack, protect the transceiver from water.
- Charge the battery pack in a place where the ambient temperature is +5 °C to +35 °C (+41 °F to +95 °F).
- If the terminals or electrodes of the battery pack are dirty, the transceiver may malfunction due to poor contact, resulting in overheating or rupture. If the terminals or electrodes get dirty, clean them using a dry cloth or cotton swab.

Tips

- The SBR-14LI battery pack can be charged in approximately 9.0 hours using the external power supply (approximately 5 hours to charge the optional battery pack FNB-101LI). If the transceiver is turned on while the battery pack is charging, the charging time will increase slightly.
- If the transceiver is connected to the external power supply with the transceiver turned off, "CONNECTED TO EXTERNAL POWER" appears on the LCD for about 20 seconds, and then "BATTERY NOT INSTALLED" appears.

Using a microSD Memory Card

Using a microSD memory card with the transceiver allows the following functions.

- Backing up the transceiver data and information
- Saving memory information
- Saving data other than images
- Saving GPS log data
- Saving image data captured with the optional camera-equipped microphone (MH-85A11U)
- Saving messages downloaded with the GM function or WIRES-X function

Usable microSD Memory Cards

This transceiver only supports the following capacity of microSD and microSDHD memory cards.

- 2GB • 4GB • 8GB • 16GB • 32GB

Cautions when Using a microSD Memory Card

- Do not bend or place heavy objects on the microSD memory card.
- microSD memory cards formatted on other devices may not properly save information when used with this transceiver. Format microSD memory cards again with this transceiver when using memory cards formatted with another device.
- Do not remove the microSD memory card or turn the transceiver off, while saving data to a microSD memory card is in progress.
- Do not insert anything other than a microSD memory card into the microSD memory card slot of the transceiver.
- Do not attempt to forcefully remove a mounted microSD memory card.

Mounting and Dismounting microSD Memory Card

- 1 Press and hold  for over one second.
The transceiver will turn off.

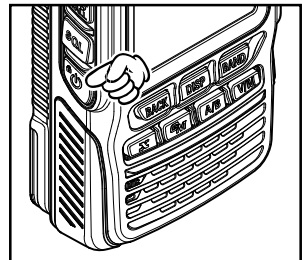

Using a microSD Memory Card

- 2 Open the microSD cover on the side of the transceiver.

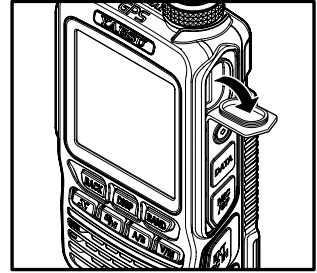

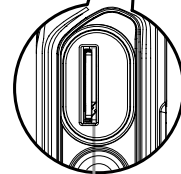
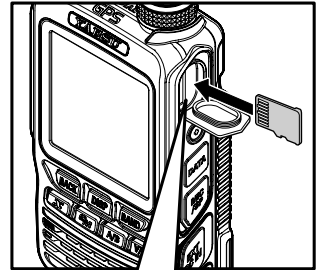

- 3 Insert the microSD memory card into the card slot until you hear a clicking sound (as shown in the figure at the right).

- Cautions**
- Ensure that the microSD memory card is facing the proper direction when inserting it.
 - Do not touch the terminal of the microSD memory card.



Do not push the microSD memory card into this space.

- 4 Close the microSD cover.
- 5 Press and hold  for over one second. The transceiver will turn on. When the microSD memory card is properly detected,  lights on the display.

Tip

Removing the microSD memory card

To remove the microSD memory card, as done in step 3 above, push the memory card in until you hear a clicking sound, then remove the memory card.

Caution

Do not turn off the transceiver while the data is being written to the microSD memory card. Doing so may corrupt the data.

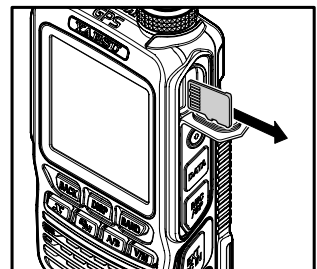
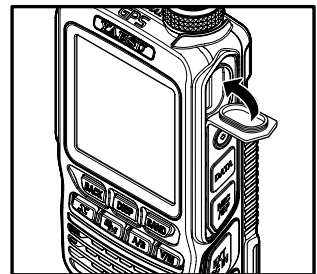

Formatting a microSD Memory Card

Format a new microSD memory card following the steps below before use.

Caution

Formatting a microSD memory card erases all data saved on it. If you are going to format the microSD memory card you are using, be sure to check the data saved on it before formatting.

- 1 Press and hold **[DISP]** key for over one second.
The “SETUP MENU” screen appears.

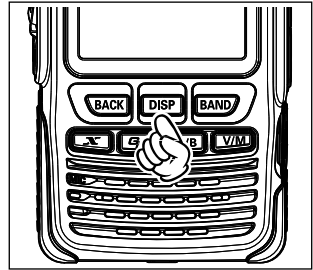

- 2 Touch **[SD CARD]**.



- 3 Touch **[4 FORMAT]**.
[FORMAT?] appears on the LCD.



- 4 Touch **[OK]**.

Tip To cancel formatting, select [Cancel].

Initialization starts and “Waiting” appears.

When formatting is completed, a beep sounds and [COMPLETED] appears on the LCD.

Tip You can also select each item by rotating the DIAL and pressing the **[DISP]** key.

Basic Operation

Performing Communication

To communicate using the transceiver in the analog communication mode, follow the procedure below:

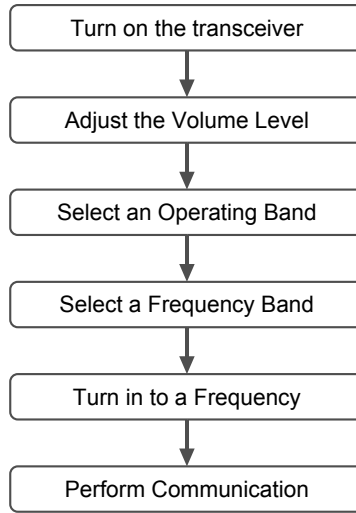

Turning on the Transceiver

- 1 Press and hold  for over one second.

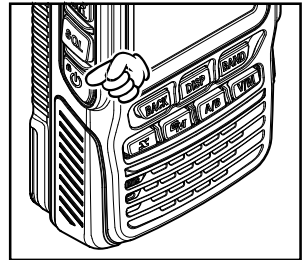

When the transceiver is turned on for the first time after purchase, the call sign input message appears on the LCD. Press the **[DISP]** key to proceed to the call sign input screen. When the transceiver is turned on the second time, and subsequently, the opening screen appears followed by the frequency screen.



- 2 Input the call sign (toggle the alphabet input screen, and the number input screen when necessary).

Supplement The alphabet input screen can be switched to the number input screen by touching [123].

The number input screen can be switched to the alphabet input screen by touching [ABC].



- 3 Press .

The call sign is set and the frequencies of both A-band and B-band are displayed simultaneously.

Supplement Factory settings are:

A-band (upper): 144.000 MHz

B-band (lower): 430.000 MHz

Tip You can change the information such as the power supply voltage and the opening message displayed at power-on. For example, press and hold [DISP] key for over one second to enter Set mode and then select [DISPLAY] → [8 OPENING MESSAGE] to change the setting.

In addition, you can also set the transceiver to display the receive frequency immediately without displaying the opening message (see page 130).

• **Turning off the Transceiver**

To turn the transceiver OFF, press and hold  for over one second.

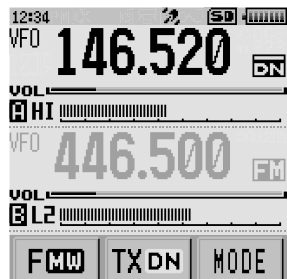
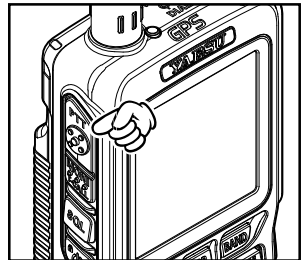

Adjusting the Volume Level

The transceiver volume levels for the A-band and B-band are adjusted separately.

- 1 Press **[A/B]** key to select the band for which the volume level is to be adjusted.

Pressing **[A/B]** key each time toggles between the A-band and B-band.

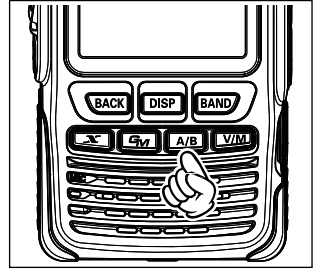

- 2 Rotate the VOL knob clockwise/counterclockwise to adjust the volume level.

The [VOL] gauge moves right/left.

Supplement If no sound is heard from the speaker, press **[X]** and then adjust the volume level while listening to white noise.

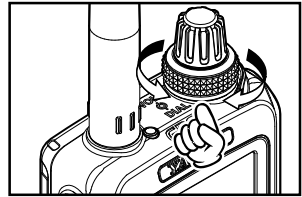

Toggling the Operating Band

Normally, both operating bands are displayed on the top half and bottom half of the transceiver touch screen. This is Dual band.

With one of the bands selected, change the frequency and radio operating mode. The selected band (displayed in black letters) is called Operating band. The other band (displayed in gray letters) is called Sub-band.

Each time pressing **[A/B]** key toggles the operating band.

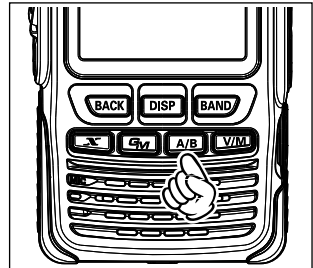

The desired operating band may also be selected by touching the frequency display.

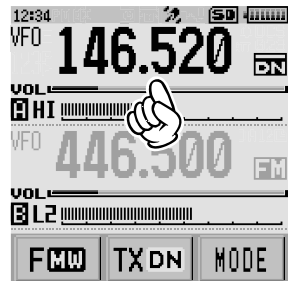

Pressing and holding **[A/B]** for over one second displays only the operating band, this is Mono-band.

For details on how to toggle the display by touching the LCD, see the following illustrations.

Tips

- On A-band, you can transmit and receive using the 144 MHz and 430 MHz Amateur radio bands.
- On B-band, you can transmit and receive using the 144 MHz and 430 MHz Amateur radio bands.
In addition, the frequencies on the chart below can be received on A-band and B-band.

Chart of A-band and B-band receive frequencies

A-band	B-band
522 kHz - 1710 kHz (AM BC Band)	— —
76 (88) MHz - 108 MHz (FM BC Band)	— —
1.8 MHz - 30 MHz (SW band)	— —
30 MHz - 76 (88) MHz (50 MHz band)	— —
108 MHz - 137 MHz (AIR band)	108 MHz - 137 MHz (AIR band)
137 MHz - 174 MHz (144 MHz band)	137 MHz - 174 MHz (144 MHz band)
174 MHz - 222 MHz	174 MHz - 222 MHz
222 MHz - 420 MHz (INFO band (1))	222 MHz - 420 MHz (INFO band (1))
420 MHz - 774(800)MHz (430 MHz band)	420 MHz - 470 MHz (430 MHz band)
470 MHz - 770 MHz	470 MHz - 580 MHz
803(800)MHz - 999MHz (INFO band (2)) Cellular Blocked USA Version	— —

() : EXP/European Version

- A-band and B-band can be received at the same time.
You can receive Amateur radio frequency while listening to the AIR band, or receive two Amateur radio frequencies on the same frequency band at the same time (V+V/U+U: Dual frequency receive on the same band).

Selecting a Frequency Band

The frequency band used for the A-band and B-band may be set separately. The frequency band can be selected by following the steps below.

- 1 Press **[A/B]** key to select A-band.

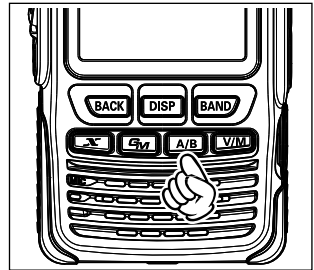

- 2 Press the **[BAND]** key to select the desired frequency.

Tip Touch **[F MW]**, then press the **[BAND]** key to switch the frequency bands in reverse order.

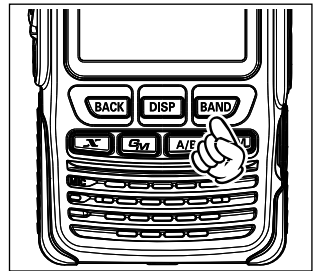

Available frequency bands differ depending on the band. The following frequency bands can be used for A-band and B-band.

• Frequency bands on A-band

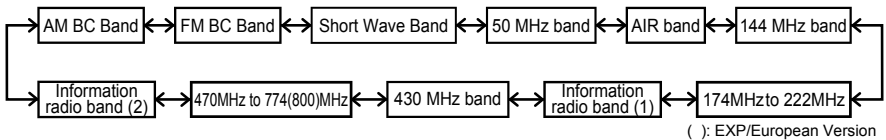

• Frequency bands on B-band

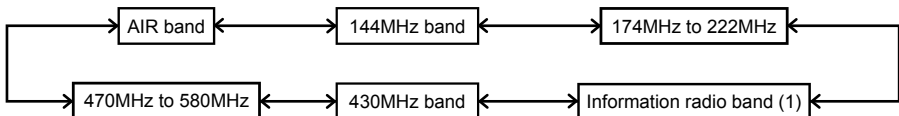

Tips

- The frequency settings from the factory are:
A-band: 144.000 MHz B-band: 430.000 MHz
- In the default, Auto mode is set so that the transceiver will be automatically set to the optimal receive mode for each frequency band.
To change the reception mode, press and hold **[DISP]** for over one second to switch to Set mode, then touch **[TX/RX]** → **[1 MODE]** → **[3 RX MODE]** (see page 48).
- For the relationship between frequency bands and receive frequencies, see the table on page 36.
- To recall the home channel of each frequency band touch **[F MW]** followed by **[HOME]** (see page 57).

Tuning to a Frequency

Tune to the desired frequency using either of the following methods:

• Rotate the DIAL to tune to the desired frequency

- 1 Press the **[V/M]** key to switch the transceiver to VFO mode.

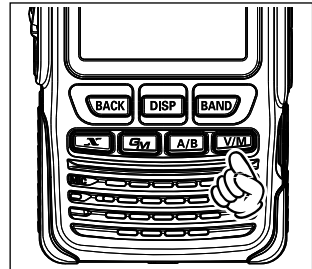

- 2 Rotate the DIAL to tune to the desired frequency.
Rotate clockwise: The frequency increases.
Rotate counterclockwise: The frequency decreases.

Tip By touching **[F MW]** and rotating the DIAL, the frequency will change in 1 MHz steps

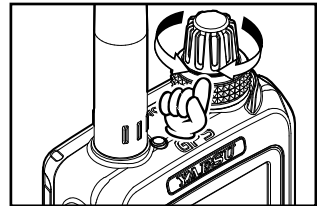

• Entering the frequency directly using the numeric keys

- 1 Press the **[V/M]** key to switch the transceiver to VFO mode.
- 2 Touch the frequency displayed on the LCD.
The numeric keypad appears.

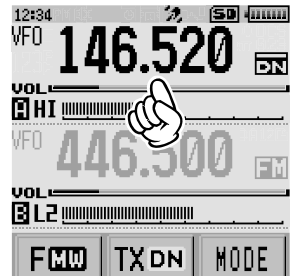

3 Enter the frequency using the numeric keys.

Example: To input 145.520 MHz

[1] → [4] → [5] → [5] → [2]

Example: To input 430.000 MHz

[4] → [3] → [ENT]



Tips

- In factory settings, Auto Step mode is set so that the transceiver is automatically switched to the optimal frequency steps for the receiver frequency.
The frequency may be changed in 1 MHz steps by touching [F MW] and rotating the DIAL (see page 47).
- If a wrong digit is entered when entering a frequency using the numeric keys, it may be canceled by pressing .
- In factory settings, turning the DIAL beyond the selected frequency band causes the transceiver to switch to the next frequency band.
To change the tuning so the frequency will move repeatedly through the selected band, press and hold [DISP] for over one second to switch to Set mode, then touch [CONFIG] → [21 VFO MODE] and select "BAND" to repeatedly show frequencies on the same frequency band.

Selecting the Communication Mode

• **Using AMS**

This transceiver is equipped with AMS (Automatic Mode Select) which automatically selects between 4 modes of transmission to correspond to the signal being received. Because the transmitter is automatically adjusted to that of the other station, C4FM digital signals and analog signals are both recognized automatically.

To utilize the AMS function, touch [MODE] to display "DN" on the LCD. After receiving the signal, "DN" of "DN" will be changed according to the received signal.

*The display differs depending on the received signal.

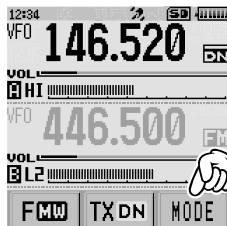

Example of when AMS is displayed

Performing Communication

• Fixing the Communication Mode

To fix the transmission mode for operation, touch **[MODE]** to switch the communication mode.

Touching **[MODE]** each time toggles the communication mode as follows.



 (AMS) → [DN (V/D mode)] → [VW (FR mode)] → [FM (analog)]

Operation mode	Icon	Description of Modes
AMS (Automatic Mode Select)		<p>The transmit mode is automatically selected from the 4 types, corresponding to the received signal. (The "DN" part of the icon differs depending on the type of the received signal.)</p> <p>By touching [TX DN], you can change the AMS function operation.</p> <p>TX M: Automatically selects one of the 4 communication modes according to the received signal. Briefly pressing PTT on the microphone switches between digital mode and analog mode.</p> <p>TX FM: Automatically selects one of the 4 communication modes according to the received signal. Always switches to FM mode for transmission.</p> <p>TX DN: Automatically selects one of the 4 communication modes according to the received signal. Always switches to DN mode for transmission.</p> <p>TX VW: Automatically selects one of the 4 communication modes according to the received signal. Always switches to VW mode for transmission.</p> <p>AUTO: Automatically selects one of the 4 communication modes according to the received signal.</p>
V/D Mode (Voice/Data simultaneous transmission mode)	DN	Calls are less prone to interruptions due to detection and correction of voice signals during digital voice signal transmission. This is the standard mode for C4FM FDMA Digital.
Voice FR Mode (Voice Full Rate Mode)	VW	High speed data communication using entire 12.5 kHz band. Enables high-quality voice communication.
Data FR Mode (High Speed Data Communication Mode)	DW	Digital voice data transmission using the entire 12.5 kHz band. The transceiver automatically switches to this mode during image transmission.
Analog FM Mode	FM	Analog communication using FM mode. Effective when the signal is weak and audio is susceptible to interruption in digital mode.

Caution

In V/D mode ("DN" on the LCD), position information is included in the radio wave during voice communication, however, position information is not included in the Voice FR mode ("VW" on the LCD).



Transmitting/Receiving Signals

- 1 While pressing and holding , speak into the microphone.
Keep your mouth about 5 cm away from the microphone when you speak.
 - 2 Release .
- The transceiver returns to receive mode.

Cautions

- Use the transceiver at the minimum required transmit power level. Doing so prevents the transceiver from overheating and saves battery power, increasing the operating time.
- Do not continue transmitting for a prolonged period. The transceiver can overheat, resulting in malfunction or a burn injury.
- If transmission is continued for a long period, the transceiver overheats and the high temperature protection function is activated. As a result, the transmitting power level is automatically set to Low Power. If you continue transmitting while the high temperature protection function is active, the transceiver will be forcibly returned to the receive mode.
- If you touch the transceiver immediately after the high temperature protection function has become active, you may be burned. Wait for the temperature inside the transceiver to cool sufficiently before resuming transmission.
- Do not start transmitting without attaching the antenna. The transmitter circuit can be damaged.

Tips

- In FM mode, you can transmit on the 144 MHz and 430 MHz ham radio bands.
- Even while receiving in AM mode, transmit will continue to be in NFM mode when pressing .
- The transmit power level may be changed by touching **[F MW]** followed by **[TXPWR]** ( see page 46).
Transmit power level settings are different when using the chargeable battery pack, or using the alkaline battery case.
For more details, see "Turning on the Transceiver" on page 32.
- If  is pressed when a frequency other than the amateur ham radio band is selected, an alarm tone (beep) will be emitted and "ERROR" appears on the LCD, disabling transmission.
- The transceiver may be set to inhibit transmit while receiving a signal. Press and hold **[DISP]** key for over one second to activate Set mode, then rotate the DIAL to the setting from **[CONFIG]** → **[2 BCLO]**, and then select **[ON]**.

Listening to the Radio

Listening to the AM/FM Radio

AM broadcasts (middle wave band) and FM broadcasts can be easily received using “Preset Memory Receiver” (see page 65), where many major broadcast stations are already saved to the transceiver memory. You can also tune in to the desired frequency by rotating the DIAL or directly inputting the frequency from the numeric keypad input screen.

- 1 Press the **A/B** key to set the A-band as the operating band.
- 2 Press the **BAND** key to select either the “AM broadcast” or “FM broadcast” band.
- 3 Rotate the DIAL or display the numeric keypad input screen to tune in to the desired frequency (see page 38).

Tips

- Broadcast stations can be saved to the memory channels (see page 54).
 - To scan a broadcast radio band, set A-band to the operating band and touch **[F MW]** followed by **[SCAN]**.
 - When a signal is detected while scanning, a beep will sound; the transceiver will receive the signal for 5 seconds then resume scanning.
 - The decimal point will flash when scanning stops.*
- *You can change the scan restart time interval.

Miscellaneous Settings

Setting Clock Time

This transceiver is equipped with an internal clock. The clock is used to display the time, and also to turn the transceiver on or off at a specified time (timer function). Set the clock before using the transceiver for the first time.

- 1 Press and hold the **[DISP]** key for over one second.
The transceiver enters Set mode.
- 2 Touch **[CONFIG]**.



- 3 Rotate the DIAL, then touch **[19 DATE & TIME ADJ.]**.
Cursors appear and blink at the last 2 digits of the year.



- 4 Rotate the DIAL to select the year, then press the **[DISP]** key.
The cursor jumps to the month.
- 5 Rotate the DIAL to select the month, then press the **[DISP]** key.
The cursor jumps to the day.
- 6 Rotate the DIAL to select the day, then press the **[DISP]** key.
The cursor jumps to the hour.
- 7 Rotate the DIAL to select the hour, then press the **[DISP]** key.

Remark The hour appears in the 24-hour clock format.
The cursor jumps to the minute.



Miscellaneous Settings

- 8 Rotate the DIAL to select the minute, then press the **[DISP]** key.

Tip If GPS information is received, the time will be set automatically.

- 9 To activate the time signal (alarm goes off every hour on the hour), touch **[SIGNAL ON]**.

The checkbox will be checked.

- 10 Touch **[OK]**.

The transceiver exits from Set mode.

Remark The current time appears on the LCD.

Tips

- At normal temperature, the time deviation is ± 30 seconds per month. It may vary depending on the environment conditions, such as the temperature .
- The transceiver is equipped with a rechargeable lithium battery dedicated for the clock. Normally, the transceiver is powered from the battery pack. When the battery pack is detached or runs out, the lithium battery starts operating automatically. The lithium battery can power the clock for approximately 2 months.
- When you use the transceiver for the first time or without the battery pack for a long period of time, the accuracy of the clock may be poor. In such case, reattach the battery pack and adjust the time.
- The calendar can display dates from January 1, 2000 A.D. up to December 31, 2099 A.D.
- Press and hold **[DISP]** for over one second to enter Set mode, then select **[APRS]** → **[21 GPS TIME SET]** followed by **[AUTO]** to display accurate time automatically.
- Using the timer function enables the transceiver to automatically turn off at a specified time (☞ see page 149). In addition, you can set the transceiver to turn on at a specified time (☞ see page 149).

Muting Audio

If the A-band and B-band are heard simultaneously during dual receive, and it is difficult to hear the voices, the audio of the non-operating band may be muted.

- 1 Press and hold the **[DISP]** key for over one second.

The transceiver enters Set mode.

- 2 Touch **[TX/RX]**.



- 3 Touch [3 AUDIO].

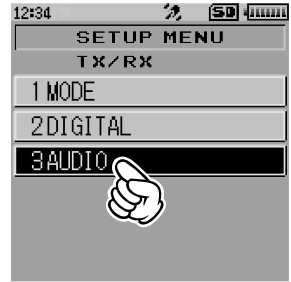

- 4 Touch [2 MUTE].
- 5 Rotate the DIAL to select the desired mute setting.
Select one of the following 4 options.
- OFF
 - MUTE 30%
 - MUTE 50%
 - MUTE 100%

The higher the value for MUTE, the more the non-operating band audio is reduced.
To deactivate the muting function, select OFF.

- 6 Press .

The transceiver exits from Set mode.

Remark When the muting function is activated,  appears on the LCD.

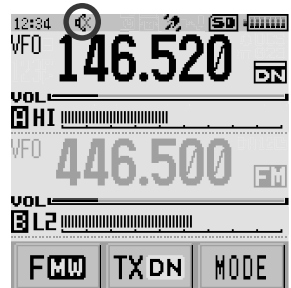

Tips

Even if the muting function is activated, the voice is not muted when no signal is received on the operating band.

Changing the Transmission Power Level

The maximum transmit power level of this transceiver is 5 W. When communicating with another station in the immediate area, or to reduce the battery power consumption, the transmit power level may be lowered. For power supply types and transmit power levels, see the table shown below.

Battery type	HIGH (High Power)	LOW3	LOW2	LOW1	
				USA/EXP	European
Battery pack	5W	2.5W	1W	0.1W	0.05W (VHF)
External power supply (DC13.8V)					0.1W (UHF)
Battery Case (alkaline battery)			Approx. 0.8W		0.05W (VHF)
					0.1W (UHF)

- 1 Touch [F MW].
- 2 Touch [TXPWR].

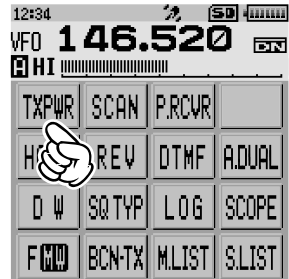

- 3 Rotate the DIAL to select one of the following transmission power levels.
"HIGH", "LOW3", "LOW2", "LOW1"
- 4 Press .
The transmit power level will be set.

Tips

- The transmitter power level may be set separately for the A-band and B-band.
- Use the transceiver at the minimum required transmit power level to reduce battery power consumption.
- By default, "HIGH (High power)" is selected.

Adjusting the Squelch Level

The raspy noise heard when no signal is being received may be muted (squelched). The squelch level can be adjusted separately for two broadcasts (FM and AM) received on the A-band and B-band.

When the squelch level is increased, the noise is more likely to be silenced, but it may become more difficult to receive weak signals. Adjust the squelch level as required.

1 Press **[A/B]** key to select the desired operating band.

2 Press **[M]**.

3 Rotate the DIAL to adjust the squelch level.

- Remarks**
- The squelch level can be adjusted within the range from 0 to 15.
 - Default: LEVEL 1.(FM radio broadcast band is LEVEL 2)

4 Press PTT.

The squelch level will be set.

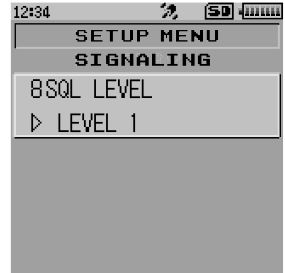

Tip

While **[M]** is held pressed, the squelch function will be open for both the A-band and B-band.

Setting the Frequency Step

You can set the frequency step to a fixed value. By default, "AUTO (Step)" is selected so that the optimum frequency step is automatically selected according to the receiver frequency.

1 Press and hold **[DISP]** key for over one second.

The transceiver enters Set mode.

2 Touch **[CONFIG]**.

3 Rotate the DIAL, then touch **[18 STEP]**.



Miscellaneous Settings

4 Rotate the DIAL to select the desired frequency step.

Remark Selectable frequency steps are as follows:

- AUTO
- 5.0KHz
- 6.25KHz
- (8.33KHz)
- 10.0KHz
- 12.5KHz
- 15.0KHz
- 20.0KHz
- 25.0KHz
- 50.0KHz
- 100.0KHz

It is recommended that AUTO be selected for normal operations.

Default: AUTO

5 Press .

The transceiver exits from Set mode.

Tips

- For the AIR band (108 MHz to 136.991 MHz), the frequency step “8.33 kHz” can also be selected.
- For bands covering 250 MHz to 300 MHz, and bands covering 580 MHz or higher, the frequency steps “5 kHz”, “6.25 kHz”, and “15 kHz” cannot be selected.

Changing the Mode

The operating mode of the selected band may be changed.

By default, “AUTO (Auto Mode)” is set so that the typical operating mode (radio wave type) is automatically selected according to the frequency band in use.

1 Press key for over one second.

The transceiver enters Set mode.

2 Touch [TX/RX].

3 Touch [1 MODE].

4 Touch [3 RX MODE].

The current setting will be displayed.

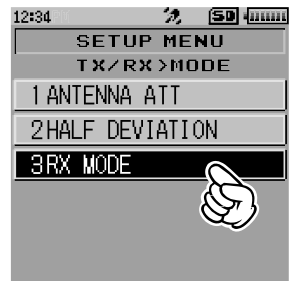

- 5 Rotate the DIAL to select the desired mode.
It is recommended that AUTO be selected for normal operation.

Display	Operation
AUTO	The optimal mode is automatically selected according to the frequency band.
NFM	Only the selected band is switched to the NFM (FM mode).
AM	Only the selected band is switched to the AM mode.



- 6 Press .
Set mode will be canceled.

Tip
Even if AM mode is selected on a ham radio band, 144 MHz band or 430 MHz band, transmission will continue to be in the FM mode.

Caution
The mode of the A-band AM/FM broadcast radio bands cannot be changed.

Locking Keys and Switches

To prevent accidental frequency change during operation, the keys, switches and DIAL (except , , , and) can be locked.

- 1 Press .
- [**LOCK**] is displayed for 1 second on the LCD.
When the lock function is activated, always appears on the LCD.

Remark To unlock a key or switch, press again.
[**UNLOCK**] is displayed on the LCD for 1 second.



Tip
To lock/unlock the operations of the DIAL and , press the [DISP] key for over one second to enter Set mode, then select [**CONFIG**] → [**9 LOCK**].

Attenuator (ATT) Function (except AM broadcasts and AM broadcasts)

If the remote station signal is too strong or there is a strong signal nearby disturbing you from hearing the remote station signal, switch the attenuator to ON. When there is no reception problem, there is no need to switch the attenuator ON.

1 Press and hold the **[DISP]** key for over one second.
The transceiver enters Set mode.

2 Touch **[TX/RX]**.

3 Touch **[1 MODE]**.

4 Touch **[1 ANTENNA ATT]**.
The current setting is displayed.



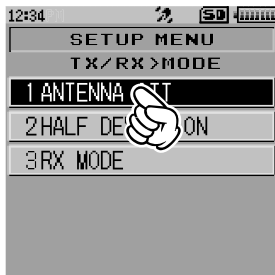

5 Rotate the DIAL to select **[ON]**.

6 Press **[F7]**.
The transceiver exits from Set mode.



Restoring to Defaults (All Reset)

To restore all transceiver settings and memory content to the defaults.

- 1 Press and hold  for over one second, then turn off the transceiver.
- 2 While pressing ,  and , press .
- 3 When the beep sounds, release the key.
“ALL RESET?” appears on the LCD.

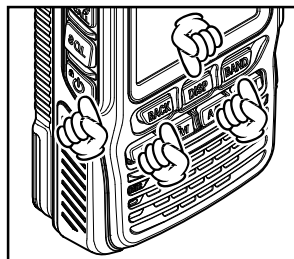



- 4 Touch **[OK]**.



A beep sounds and the call sign input message appears on the LCD.

Remark To cancel resetting, touch **[CANCEL]**.

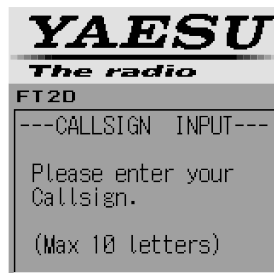

- 5 Press the  key.
The call sign input screen appears.
 - 6 Input your call sign.
Switch the display between the alphabet keys and number keys to input the call sign.
 - 7 Press .
- The call sign is set and the frequency screen appears.



Caution

When the All Reset function is performed, all data registered in the memory will be deleted. Be sure to note the settings on paper or back up the data on a microSD memory card. For details on how to save backup onto a microSD memory card, see “Set Mode: SD CARD Menu Operations” on page 154.

Tip

To restore only the Set Mode settings to default, while pressing  and , press  to turn on the transceiver.

Repeater Operation

Communicating Via the Repeater

The transceiver includes an ARS (Automatic Repeater Shift) function which enables repeater operation automatically when setting the receiver to the repeater frequency.

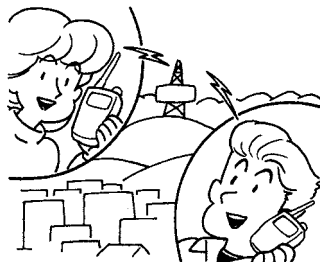

- 1 Set the receiver frequency to the repeater frequency.
“**[M]**” or “**[R]**” appears on the left side of the frequency whereas “**TN**” and the tone frequency appear on the right side of the frequency.
- 2 Begin transmitting by pressing and holding **[M]**. The transmitter will automatically be set to the programmed offset frequency and CTCSS tone.

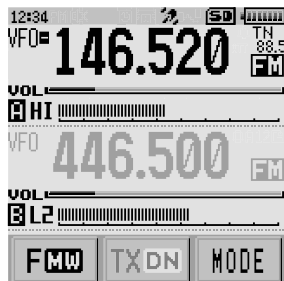

Tips

- Touching **[F MW]** followed by **[REV]** enters the “reverse” state where the transmission frequency and the receive frequency are temporarily reversed. This allows checking to find if direct communication with the remote station is possible.
- In the “reverse” state, “**[M]**” blinks on the LCD.
- Touching **[F MW]** followed by **[REV]** again exits from the “reverse” state.
- Press and hold **[DISP]** for over one second to enter Set mode, then configure the following repeater settings for more convenient use.

[CONFIG] → **[14 RPT ARS]**: Deactivates the ARS function.

[CONFIG] → **[15 RPT SHIFT]**: Allows setting the repeater shift direction.

[CONFIG] → **[16 RPT SHIFT FREQ]**: Allows changing the repeater shift offset

Repeater Shift



The FT2DR/DE has been configured, at the factory, for the repeater shifts customary in the country where it is sold. For the 144 MHz band, this usually will be 600 kHz, while the 430 MHz shift will be 1.6 MHz, 7.6 MHz, or 5 MHz (USA version).

Depending on the part of the band in which you are operating, the repeater shift may be either downward (-) or upward (+), and one of these icons will appear to the right of the display frequency on the LCD when repeater shifts have been enabled.





Automatic Repeater Shift (ARS)

The FT2DR/DE Automatic Repeater Shift feature causes the appropriate repeater shift to be automatically applied whenever it is tuned into the designated repeater sub-bands. If the ARS feature does not appear to be working, you may have accidentally disabled it.

To re-enable ARS:

- 1 Press and hold the  key for over one second.
The transceiver enters Set mode.
 - 2 Touch **[CONFIG]**.
 - 3 Rotate the DIAL, then touch **[14 RPT ARS]**.
 - 4 Rotate the DIAL to select **[ON]** (to enable Automatic Repeater Shift).
 - 5 Press .
- The transceiver exits from Set mode.

Tone Calling (1750 Hz)

If your transceiver is FT2DE (European version), press and hold in the press and hold the  switch (just below the  switch) to generate a 1750 Hz burst tone to access the European repeater. The transmitter will automatically be activated, and a 1750 Hz audio tone will be superimposed on the carrier. Once access to the repeater has been gained, you may release the  switch, and use the  switch for activating the transmitter thereafter. If you need to access the repeaters which requires a 1750 Hz burst tone for access by the FT2DR (USA/EXP versions), you can set the  switch to serve as a "Tone Call" switch instead. To change the configuration of this switch, use Set Mode **[CONFIG]** → **[10 MONI/T-CALL]**.

A Wide Variety of Memory Functions

The FT2DR/DE transceiver incorporates the following types of memory channels in addition to the regular memory channels (numbers 001 to 900).

- [Home channels] which can be recalled on each frequency band just by touching a key (☞ see page 57)
- Preset Receiver Memory Channels include the International VHF marine radio (57 channels) and Worldwide Wide Broadcasts (89 channels) (☞ see page 65)
- 99 (901 to 999) skip search memory channels that allow skipping unwanted frequencies during VFO scanning (☞ see page 72)
- 50 sets of memory channels (L1/U1 to L50/U50) for programmable memory channel scanning (PMS) (☞ see page 81)

The operating frequency and other operational information can be registered to each regular memory channel, home channel, or PMS memory channel:

- Operating frequency
- Memory tag
- Repeater information
- Tone information
- DCS information
- Memory channel skip information
- Transmitter output

(The analog/digital operating mode is not registered to the memory channel)

Memory channels can be sorted and registered into memory banks according to the intended use. The transceiver allows you to use 24 types of memory banks. A maximum of 100 memory channels can be registered in each memory bank. A name can be assigned to each memory bank with up to 16 characters. (☞ see page 64)

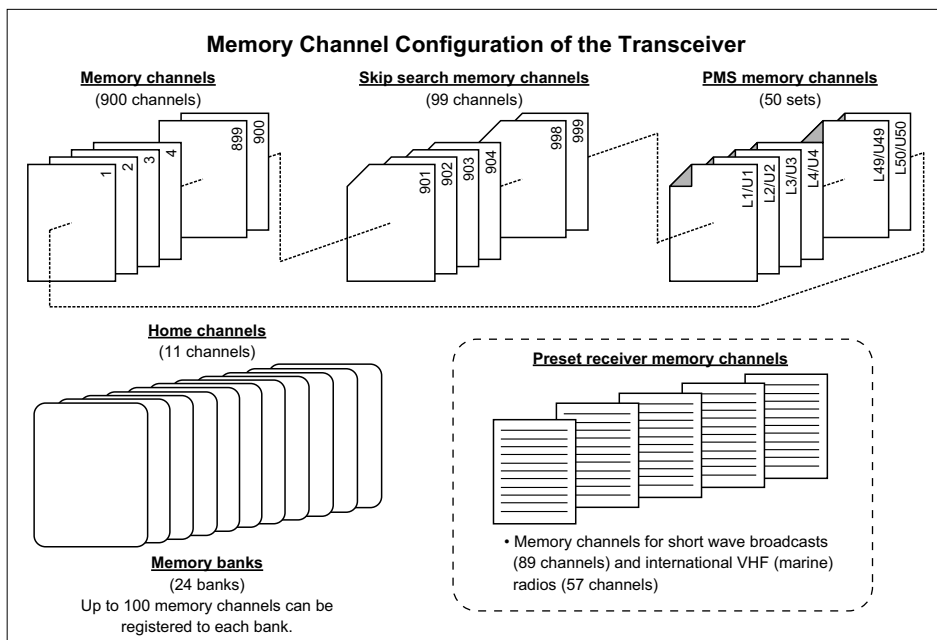

Registering to Memory Channel

Caution

The information registered to memory channels can be corrupted by incorrect operation, static electricity, or electrical noise. Also, it can be erased in the event of a failure or repair. Be sure to keep a record of the settings on paper or back up the data to the microSD memory card. For details on saving a backup onto a microSD memory card, see "Set Mode: SD CARD Menu Operations" on page 154.

The transceiver allows programming 900 memory channels (memory channel numbers 1 to 900).

- 1 Press the **[V/M]** key to enter VFO mode.

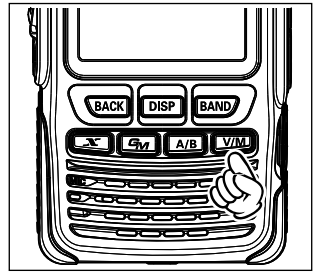

- 2 Rotate the DIAL to tune to the frequency to be registered to a memory channel.

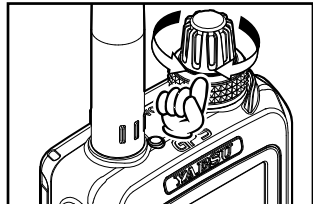

- 3 Touch **[F MW]** for over one second.
The transceiver will enter Memory Channel Registration mode, and the number of the next available memory channel will flash on the LCD.

Remarks

- To cancel the memory channel registration, press **[M]**.
- To specify some other memory channel to register the frequency, select the memory channel by rotating the DIAL.
If the specified memory channel is unregistered, the **[M]** icon will be shown, and the memory channel will flash.
If the specified memory channel is previously registered, the **[M]** lights up.

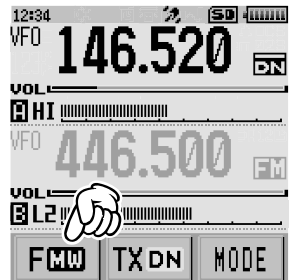

A Wide Variety of Memory Functions

4 Touch [M.WRITE].

The frequency registration will initiate.

If you attempt to register a frequency to a memory channel on which another frequency has already been registered, "OVERWRITE?" will appear on the LCD.

When [OK] is selected, touch [OK] to register the frequency to the memory channel.

Once the registration is completed, the VFO frequency will again appear on the display.

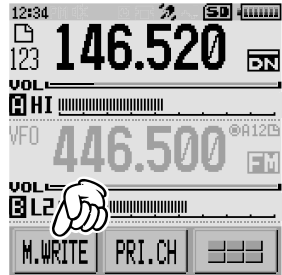

Tips

- By default, 144.000 MHz is registered to the memory channel 1. It can be changed to another frequency, but cannot be deleted.
The frequency which has been registered to a memory channel can be overwritten with a new frequency.
When registering a frequency to a memory channel, an unregistered memory channel automatically appears.
- To display the lowest unregistered memory number when registering a frequency to a memory channel, press and hold [DISP] key for over one second to enter Set mode, and then select [MEMORY] → [6 MEMORY WRITE].
- To inhibit registration to all memory channels, press and hold [DISP] key for over one second to enter Set mode, and then select [MEMORY] → [4 MEMORY PROTECT].

Split Memory

Two different frequencies, one for receive and another for transmit, can be registered to a memory channel.

1 Register a receive frequency to a memory channel.

Remark See "Registering to Memory Channel" above.

2 Set a transmit frequency in VFO mode.

3 Touch [F MW] for over one second.

4 Rotate the DIAL to select the channel that the receive frequency was registered to.

5 While pressing , touch [M.WRITE].

When the memory channel to which two different frequencies (one for receive and the other for transmit) is recalled,  appears on the LCD.



Recalling a Memory Channel

Recall a registered memory channel by following the steps below.

- 1 Press the **[V/M]** key to enter Memory mode.

The memory channel most recently used appears on the LCD.

- 2 Rotate the DIAL to select the desired memory channel.

Remark Touching **[F MW]** and rotating the DIAL allows skipping memory channels quickly in steps of 10 memory channels.

- 3 Press **[V/M]**.

Memory mode will be exited, and the frequency selected in VFO mode will be displayed.

Tips

- Unregistered memory channels are skipped.
- By default, memory channel number 1 is used as a dual receive priority memory channel, "P" appears on the upper right corner of the priority memory channel number (see page 96).
- The data registered to a memory channel can be transferred to the VFO operating band by following the procedure below.
Touch **[F MW]** for over one second. → Touch **[MEM]** → Touch **[V.WRITE]**. → "OVERWRITE?" appears. → Select **[OK]**, then touch **[OK]** to confirm.
- The transceiver may be placed into a Memory Channel Only mode, (which restricts the FT2DR/DE operation to memory channels only), by pressing **[V/M]**, while pressing **[M]** to turn the transceiver on.
To cancel the Memory Channel Only mode, press **[V/M]**, while pressing **[M]** again.

Recalling the Home Channels

- 1 Touch **[F MW]**.

The function menu appears on the LCD.

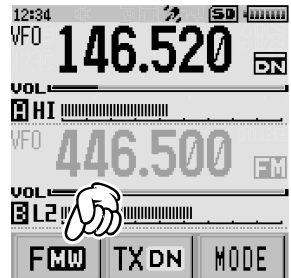

A Wide Variety of Memory Functions

2 Touch [HOME].



The home channel of the currently selected frequency band appears on the LCD.

- Tips**
- For details on the home channels displayed on the LCD, see the following table.
 - After selecting the desired frequency, rotating the DIAL returns the transceiver to VFO mode.

Frequency band	Frequency	Frequency band	Frequency
AM Band	540 kHz	174 to 222 MHz band	174.000 MHz
FM Band	76.000 (88.000) MHz	Information radio band (1)	222.000 MHz
SW band	1.800 MHz	430 MHz band	446.000 (430.000) MHz
50 MHz	50.000 MHz	470 to 770 MHz band	47.000 MHz
AIR band	108.000 MHz	Information radio band (2)	860.000 MHz
144 MHz band	146.520 (144.000) MHz		

Returning to the Previous Frequency

1 Touch [F MW].

The function menu appears on the LCD.

2 Touch [HOME].

The frequency band selected before recalling the home channel appears on the LCD.

Changing the Home Channel Frequency

Change the home channel frequencies from the default setting.

- 1 Press the **[V/M]** key to enter VFO mode.
- 2 Rotate the DIAL to tune in to the frequency you want to set as a home channel.
- 3 Touch **[F MW]** for over one second.
- 4 Touch **[]**.
- 5 Touch **[H.WRITE]**.
- 6 "OVERWRITE?" appears.
- 7 Select **[OK]**, then touch **[OK]** to confirm.

Overwriting completes and the home channel frequency is changed.

Clearing Memories

- 1 Press the **[V/M]** key to enter Memory mode.
- 2 Touch **[F MW]** for over one second.
- 3 Rotate the DIAL to select the memory channel from which the data is to be cleared.
- 4 Touch **[]**.
- 5 Touch **[M.DEL]**.
- 6 “DELETE?” appears.
- 7 Select **[OK]**, then touch **[OK]** to confirm.

Remark To cancel the memory clear operation, touch **[CANCEL]**.

The memory data is cleared.

Remark To clear data from other memory channels, repeat steps 2 to 7.



Caution

Data on memory channel 1 cannot be deleted.

Tip

Memories cannot be cleared from the specified priority memory channel. To clear a priority memory channel, cancel the priority setting of the memory channel.

Restoring the Cleared Memories

The cleared memory channels may be restored:

- 1 Press the **[V/M]** key to enter Memory mode.
The most recently used memory channel is displayed.
- 2 Touch **[F MW]** for over one second.
- 3 Rotate the DIAL to select the memory channel, to restore the memory data.
- 4 Touch **[]**.
- 5 Touch **[M.REV]**.
The cleared data is restored to the memory channel.

Using Memory Tag

Memory name tags, such as a call sign or broadcast station name may be assigned to the memory channels and home channels. Input a memory tag using up to 16 characters. Alphabetic characters (upper and lowercase), Numbers and Symbols may be entered to the memory name tag.

Assigning a Name to a Memory Channel

- 1 Press the **[V/M]** key to enter Memory mode.
- 2 Recall the memory channel to assign the name.

Tip

To assign a name to a home channel, recall the desired home channel.

- 3 Press and hold **[DISP]** for over one second.
The transceiver enters Set mode.
- 4 Touch **[MEMORY]**.



- 5 Touch **[3 MEMORY NAME]**.



- 6 See “Entering Letters” on page 19 to input a memory tag.



- 7 Press **[F1]**.
The memory tag is saved to the memory channel, and the transceiver exits from Set mode.

Displaying the Memory Tag

During mono band operation, the tag (name) of the memory channel or home channel can be displayed by following the procedure below.

- 1 Press the **V/M** key to enter Memory mode.
- 2 Press and hold the **A/B** key for over one second.

The mono-band-operation display appears, and the name tag appears under the frequency.

The name tag also appears under the frequency when the frequency is displayed in double-sized characters.

- Tips**
- Touch the Name, Date, or Volt display to display the memory tag name in double-sized characters.
 - Touch the display again to restore the font size to the original.



Using Memory Bank

The registered memory channels can be sorted according to the intended use. The transceiver allows using up to 24 memory banks. A maximum of 100 memory channels can be registered in each memory bank. One memory channel may also be registered in two or more memory banks. If the data on a memory channel is edited or updated, the data on the corresponding memory channel in the memory banks is automatically edited or updated.

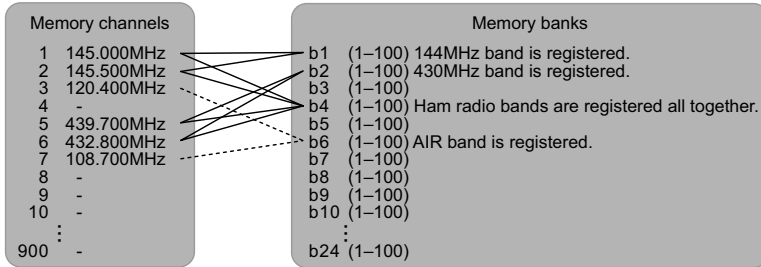



Registering to Memory Banks

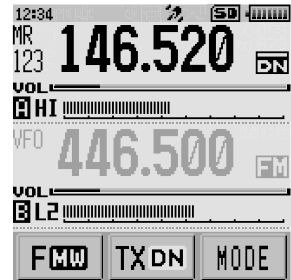

- 1 Press the **[V/M]** key, to enter Memory mode.
- 2 Rotate the DIAL to select the memory channel to register in the memory bank.
- 3 Touch **[F MW]** for over one second.
Memory Write mode is activated.
- 4 Rotate the DIAL to select the memory bank (B1 to B24) to register the memory channel.
- 5 Touch **[M.WRITE]**.
The memory channel is registered in the selected memory bank.



Tips

- To register the preset receiver memory channels in the memory bank, see “Registering Preset Receiver Memory Channels into Memory Banks” on page 66.
 - Rotating the DIAL selects the memory channels, skip search memory channels, and programmable memory channels on the LCD in the following sequence:
1 ↔ 2 ↔ 3 ↔ ...L50 ↔ U50 ↔ BANK 1 ↔ BANK 2 ↔ ...BANK 24 ↔ 1 ↔ 2...
- Memory bank channels are displayed when the DIAL is turned counterclockwise from channel [1], or when the DIAL is rotated clockwise from channel [U50].
- If the memory bank name was changed, the changed bank name appears.
 -  appears for a memory bank in which no memory channel is registered, and  appears for a memory bank in which at least one memory channel is registered.

Recalling Memory Bank

- 1 Press the  key, to enter Memory mode.
- 2 Touch **[F MW]**.
- 3 Touch **[BANK]**.
- 4 Press the  key.
- 5 Rotate the DIAL to select the desired memory bank.
- 6 Press the  key.
The memory bank to be used is determined.
- 7 Rotate the DIAL to select the desired memory channel in the memory bank.

- Remarks**
- To select other memory banks, repeat steps 4 to 6.
 - To return to the regular memory channel mode, touch **[F MW]** followed by **[MR]**.

Canceling Memory Channel Registration in Memory Bank

- 1 To cancel the registration, recall the memory bank where the desired memory channel is registered.
Remark For details on operations, see “Recalling Memory Bank”.
- 2 Rotate the DIAL to select the memory channel you want to cancel the registration.
- 3 Touch **[F MW]** for over one second.
- 4 Touch .
- 5 Touch **[M.DEL]**.

The registration is canceled, and the display returns to the memory bank display. If no other memory channels are registered in the memory bank, the memory bank having the lowest number is displayed.

Assigning Name to Memory Bank

A name can be assigned to a memory bank using up to 16 characters.

The following types of characters can be entered:

- Alphabetic characters (uppercase and lowercase characters)
- Numbers
- Symbols

- 1 Press and hold the **[DISP]** key for over one second.
The transceiver enters Set mode.
- 2 Touch **[MEMORY]**.
- 3 Rotate the DIAL, then touch **[2 BANK NAME]**.



- 4 Rotate the DIAL to select a memory bank.
Select the number of the memory bank to which you want to assign a name.
- 5 Press and hold the **[DISP]** key
- 6 Input a bank memory name (See “Entering Letters” on page 19).
- 7 Press **[END]**.
The memory bank name is saved, and the transceiver exits from Set mode.

Convenient Preset Receiver Memory Channels

Weather Broadcast (10 channels), International VHF Marine Radio (57 channels) and Shortwave Broadcasts Stations (89 channels) are recorded in the preset receiver memory channels.

- **Weather Broadcast preset receiver memory channels [WX CH] are listed on: Page 66**
The frequencies (10 channel) used for the VHF Weather Broadcast Station are registered to the dedicated preset receiver memory channels.
- **International VHF Marine Radio preset receiver memory channels [INTVHF] are listed on: Page 67**
The frequencies (57 channel) used for the international VHF (marine) radio are registered to the dedicated preset receiver memory channels.
- **International World Wide Broadcast preset receiver memory channels [SW] are listed on: Page 68**
Listen in to major broadcasts from around the world (89 channels in total).

Registering Preset Receiver Memory Channels into Memory Banks

Your favorite preset receiver memory channels may be registered into a memory bank.

- 1 Rotate the DIAL to select the preset receiver memory channel to register into the memory bank.
- 2 Touch **[F MW]** for over one second.
- 3 **Remark** To immediately cancel the registration, press .
- 3 Rotate the DIAL to select a memory bank to register your favorite preset receiver memory channel.
- 4 Touch **[M.WRITE]**.

The preset receiver memory channel is registered to the memory bank, and the frequency appears on the LCD.

Recalling Preset Receiver Memory Channel to Listen to the Weather Broadcast

The frequencies (10 channels) used for the VHF Weather Broadcast Station are registered in the dedicated preset receiver memory channels.

- 1 Press the **[A/B]** key to set the A-band as the operating band.
- 2 Touch **[F MW]**.
- 3 Touch **[P.RCVR]**.
Preset Receiver mode is activated.
- 4 Press the **[BAND]** key to select [WX CH].
- 5 Rotate the DIAL to select the desired channel.

- Remarks**
- For the available Weather Broadcast channels, see the following table.
 - To stop reception of the international VHF radio, touch **[F MW]** followed by **[P.RCVR]**.

WX Channel Frequency List

Memory channel No.	Frequency (MHz)	Memory channel No.	Frequency (MHz)
1	162.550	6	162.500
2	162.400	7	162.525
3	162.475	8	161.650
4	162.425	9	161.775
5	162.450	10	163.275

Recalling Preset Receiver Memory Channel to Listen to the International VHF (Marine) Radio

The frequencies (57 channels) used for the international VHF marine radio are registered in the dedicated preset receiver memory channels.

- 1 Press the **[A/B]** key to set the A-band as the operating band.
- 2 Touch **[F MW]**.
- 3 Touch **[P.RCVR]**.
Preset Receiver mode is activated.
- 4 Press the **[BAND]** key to select [INTVHF].
- 5 Rotate the DIAL to select the desired channel.

- Remarks**
- For the available international VHF channels, see the following table.
 - To stop reception of the international VHF radio, touch **[F MW]** followed by **[P.RCVR]**.

In the event of extreme weather disturbances, such as storms and hurricanes, the NOAA (National Oceanic and Atmospheric Administration) sends a weather alert accompanied by a 1050 Hz tone and subsequent weather report on one of the NOAA weather channels. You may enable the Weather Alert tone via Set Mode option [SIGNALING] → [14 WX ALERT], if desired (See page 124).

Tips

- The preset receiver memory channel cannot be rewritten with another frequency or data.
- To scan the preset receiver memory channels toward higher channel numbers, touch **[F MW]** followed by **[SCAN]**. To scan the preset receiver memory channels toward lower channel numbers, rotate the DIAL counterclockwise until it clicks once during scanning. When a signal is received during scanning, the scanning stops to receive the frequency for 5 seconds.
- To set the transceiver operation when scanning stops, see "Setting the Receiver Operation" "Setting the Receive Operation When Scanning Stops" on page 74.
- To register the International VHF Marine channels into a memory bank, follow the procedure in "Registering Preset Receiver Memory Channels into Memory Banks" on page 66.



Frequencies of International VHF Marine radio frequencies registered in the preset receiver memory channels

Memory channel No.	Frequency (MHz)		Memory channel No.	Frequency (MHz)	
1	156.050	160.650*	60	156.025	160.625*
2	156.100	160.700*	61	156.075	160.675*
3	156.150	160.750*	62	156.125	160.725*
4	156.200	160.800*	63	156.175	160.775*
5	156.250	160.850*	64	156.225	160.825*
6	156.300		65	156.275	160.875*
7	156.350	160.950*	66	156.325	160.925*
8	156.400		67	156.375	
9	156.450		68	156.425	
10	156.500		69	156.475	
11	156.550		70	156.525	
12	156.600		71	156.575	

Convenient Preset Receiver Memory Channels

Memory channel No.	Frequency (MHz)		Memory channel No.	Frequency (MHz)	
13	156.650		72	156.625	
14	156.700		73	156.675	
15	156.750		74	156.725	
16	156.800		75	156.775	
17	156.850		76	156.825	
18	156.900	161.500*	77	156.875	
19	156.950	161.550*	78	156.955	161.550*
20	157.000	161.600*	79	156.975	161.575*
21	157.050	161.650*	80	157.025	161.625*
22	157.100	161.700*	81	157.075	161.675*
23	157.150	161.750*	82	157.125	161.725*
24	157.200	161.800*	83	157.175	161.775*
25	157.250	161.850*	84	157.225	161.825*
26	157.300	161.900*	85	157.275	161.875*
27	157.350	161.950*	86	157.325	161.925*
28	157.400	162.000*	87	157.375	161.975*
			88	157.425	162.025*

Remark

* indicates the frequency of the VHF marine base station. For example: if the preset receiver memory channel 1 is selected, the base station frequency 160.650 MHz appears and  lights up. Touching **[F MW]** followed by **[REV]** displays the Ship Station frequency 160.650 MHz and  lights up. The frequency lower than the base station frequency by 4.6 MHz is the Ship Station frequency and duplex operation may commence. To return to the base station frequency, press **[F MW]** followed by **[REV]**.

Recalling Preset Receiver Memory Channels to Listen to World Wide Broadcasts

The frequencies (89 channels) used for international worldwide broadcasting are registered to the dedicated preset receiver memory channels.

- 1 Press the **[A/B]** key to set the A-band as the operating band.
- 2 Touch **[F MW]**.
- 3 Touch **[P.RCVR]**.
Preset Receiver mode is activated.
- 4 Press the **[BAND]** key to select [SW].
- 5 Rotate the DIAL to select the desired channel.

Remarks • For the available world broadcast station frequencies, see the following table.
• To stop reception of the world broadcast, touch **[F MW]** followed by **[P.RCVR]**.

- Depending on time zone or signal strength, broadcasts may not be received.
- There are broadcast stations other than those listed below that can also be received. In addition, the broadcast station frequency may be changed, it may be off-air or have become abolished. For current details, please refer to a commercially available frequency list.

Convenient Preset Receiver Memory Channels

Worldwide short wave broadcast

CH Number	Frequency (MHz)	Name	Broadcast Station Name	CH Number	Frequency (MHz)	Name	Broadcast Station Name
1	6.030	VOA	USA	43	15.550	PORTUGAL	Portugal
2	6.160	VOA	USA	44	21.655	PORTUGAL	Portugal
3	9.760	VOA	USA	45	9.650	SPAIN	Spain
4	11.965	VOA	USA	46	11.880	SPAIN	Spain
5	9.555	CANADA	Canada	47	11.910	SPAIN	Spain
6	9.660	CANADA	Canada	48	15.290	SPAIN	Spain
7	11.715	CANADA	Canada	49	6.055	NIKKEI	Japan (Nikkei)
8	11.955	CANADA	Canada	50	7.315	NORWAY	Norway
9	6.195	BBC	UK	51	9.590	NORWAY	Norway
10	9.410	BBC	UK	52	9.925	NORWAY	Norway
11	12.095	BBC	UK	53	9.985	NORWAY	Norway
12	15.310	BBC	UK	54	6.065	SWEDEN	Sweden
13	6.090	FRANCE	France	55	9.490	SWEDEN	Sweden
14	9.790	FRANCE	France	56	15.240	SWEDEN	Sweden
15	11.670	FRANCE	France	57	17.505	SWEDEN	Sweden
16	15.195	FRANCE	France	58	6.120	FINLAND	Finland
17	6.000	DW	Germany	59	9.560	FINLAND	Finland
18	6.075	DW	Germany	60	11.755	FINLAND	Finland
19	9.650	DW	Germany	61	15.400	FINLAND	Finland
20	9.735	DW	Germany	62	5.920	RUSSIA	Russia
21	5.990	ITALY	Italy	63	5.940	RUSSIA	Russia
22	9.575	ITALY	Italy	64	7.200	RUSSIA	Russia
23	9.675	ITALY	Italy	65	12.030	RUSSIA	Russia
24	17.780	ITALY	Italy	66	7.465	ISRAEL	Israel
25	7.170	TURKEY	Turkey	67	11.585	ISRAEL	Israel
26	7.270	TURKEY	Turkey	68	15.615	ISRAEL	Israel
27	9.560	TURKEY	Turkey	69	17.535	ISRAEL	Israel
28	11.690	TURKEY	Turkey	70	6.045	INDIA	India
29	9.660	VATICAN	Vatican	71	9.595	INDIA	India
30	11.625	VATICAN	Vatican	72	11.620	INDIA	India
31	11.830	VATICAN	Vatican	73	15.020	INDIA	India
32	15.235	VATICAN	Vatican	74	7.190	CHINA	China
33	5.955	NEDRLAND	Netherlands	75	7.405	CHINA	China
34	6.020	NEDRLAND	Netherlands	76	9.785	CHINA	China
35	9.895	NEDRLAND	Netherlands	77	11.685	CHINA	China
36	11.655	NEDRLAND	Netherlands	78	6.135	KOREA	South Korea
37	5.985	CZECH	Czech Republic	79	7.275	KOREA	South Korea
38	6.105	CZECH	Czech Republic	80	9.570	KOREA	South Korea
39	9.455	CZECH	Czech Republic	81	13.670	KOREA	South Korea
40	11.860	CZECH	Czech Republic	82	6.165	JAPAN	Japan
41	9.780	PORTUGAL	Portugal	83	7.200	JAPAN	Japan
42	11.630	PORTUGAL	Portugal	84	9.750	JAPAN	Japan

Convenient Preset Receiver Memory Channels

CH Number	Frequency (MHz)	Name	Broadcast Station Name
85	11.860	JAPAN	Japan
86	5.995	AUSTRALIA	Australia
87	9.580	AUSTRALIA	Australia

CH Number	Frequency (MHz)	Name	Broadcast Station Name
88	9.660	AUSTRALIA	Australia
89	12.080	AUSTRALIA	Australia

Receive Mode: AM

Scanning Function

The transceiver supports the following three scanning functions:

- VFO Scan
- Memory Channel Scan
- Programmable Memory Channel Scan (PMS)

VFO Scan

- 1 Press the **[V/M]** key to switch the transceiver to VFO mode.
- 2 Press the **[A/B]** key to select the operating band you want to scan.

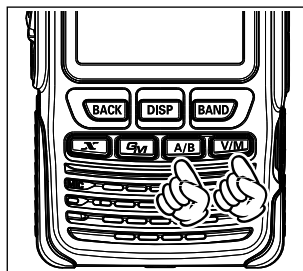

- 3 Touch **[F MW]**.
The function menu appears on the LCD.

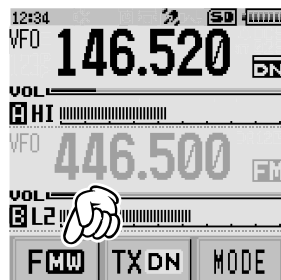

- 4 Touch **[SCAN]**.
Scanning (SCAN) starts toward higher frequencies.

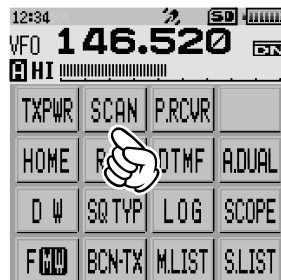

VFO Scan

- Tips**
- When a signal is received during scanning, the decimal point blinks.
 - Rotate the DIAL clockwise to start scanning toward higher frequencies.
 - Rotate the DIAL counterclockwise to start scanning toward lower frequencies.
 - When a signal is received during scanning, a beep sound is emitted. Then, scanning stops for 5 seconds to monitor the frequency. When scanning stops, the decimal point blinks and the LCD remains illuminated. After receiving the signal for 5 seconds, scanning resumes.
 - To select the range for scanning, enter Set mode by pressing and holding the **[DISP]** key for over one second, then select **[SCAN]** followed by **[5 SCAN WIDTH]**.

When a signal is received during scanning, the decimal point blinks.

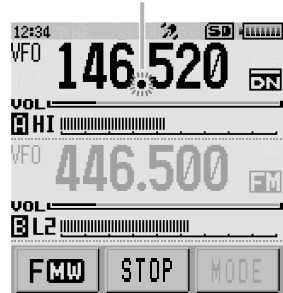

Canceling Scanning

To exit scanning, touch **[STOP]** or press .

Tips

- To set the transceiver action when scanning stops, see “Setting the Receive Operation When Scanning Stops” on page 74.
- Press and hold the **[DISP]** key for over one second to enter Set mode, then configure the following operating preferences settings.
 - [CONFIG]** → **[3 BEEP]** → **[SELECT]**: Sets whether or not the beep sound is emitted when scanning stops.
 - [CONFIG]** → **[3 BEEP]** → **[EDGE]**: Sets whether or not the beep sound is emitted when the frequency band edge or memory channel 01 is reached during scanning.
 - [SCAN]** → **[2 SCAN LAMP]** Sets whether or not the LCD is illuminated when scanning stops.

Skipping Frequencies You Do Not Want to Scan (Skip Search Memory)

During VFO scan, scanning may stop at a frequency that you do not want to receive. The unwanted frequency can be skipped by registering it to the “skip search memory channels” in advance. Up to 99 frequencies can be saved onto the skip search memory channels (memory channels 901 to 999).

Specifying the Frequencies You Do Not Want to Scan

- 1 Start VFO scanning.
Start VFO scanning referring to “VFO Scan” on page 71.
- 2 When scanning stops at a frequency you do not want to receive, touch **[F MW]** for over one second.
The number of the next unused skip search memory channel will blink.

Tip A different skip search memory channel may be specified by rotating the DIAL.

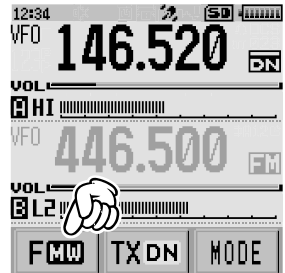

- 3 Touch **[M.WRITE]**.
After completing registration to the skip memory channel, scanning resumes.

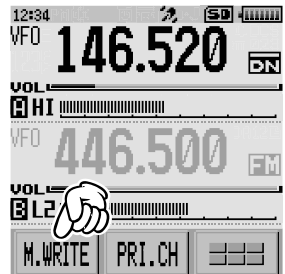

Tips • Follow the procedure below to register the frequencies you do not want to scan to the “skip search memory channels” in advance.

- 1 In VFO mode, tune in to the frequency you do not want to scan.
- 2 Touch **[F MW]** for over one second.
- 3 Rotate the DIAL to select the desired skip search memory channel (901 to 999).
- 4 Touch **[M WRITE]**.

Deleting the Frequency Registered to the Skip Search Memory Channel

Frequencies can be removed from the skip search memory channels by following the procedure below. Once the frequencies are removed from the skip search memory channels, they can then be scanned.

- 1 Press the **[V/M]** key to enter Memory mode.
- 2 Touch **[F MW]** for over one second.
- 3 Rotate the DIAL to select the skip search memory channel (901 to 999) that is to be cleared.

VFO Scan

- 4 Touch .
- 5 Touch **[M.DEL]**.
[DELETE OK?] appears on the LCD.
- 6 Select **[OK]**, then touch **[OK]** to confirm.



The frequency is removed from the skip search memory channel.

Tip To remove other frequencies from the skip search memory channels, repeat steps 2 to 6.

Tip

- Restoring the deleted Frequency to the Skip Search Memory Channel
If you have not registered a new frequency to the same memory channel, you can restore the deleted frequency by repeating steps 1 through 4, then touching **[M.REX]**.

Setting the Receive Operation When Scanning Stops

When scanning stops, one of the following three receiving options may be chosen:

- (1) The signal is received for a specified period of time, and then scanning resumes. The scan resume time may be set from 2 to 10 seconds at 0.5 second intervals.
- (2) The signal is received and **[BUSY]** appears on the LCD until the signal fades out. Two seconds after the signal fades out, scanning resumes.
- (3) Scanning stops and the current frequency is received. **[HOLD]** appears on the LCD.

- 1 Press and hold the **[DISP]** key for over one second.
The transceiver enters Set mode.

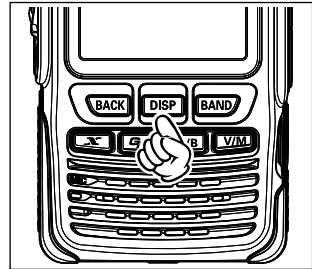

2 Touch [SCAN].



3 Touch [4 SCAN RESUME].

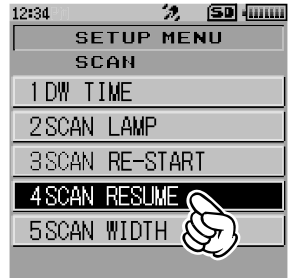

4 Rotate the DIAL to select [SCAN], then press the **[DISP]** key.

5 Rotate the DIAL to select the desired reception method from [2 SEC TO 10 SEC (0.5SEC STEP)], [BUSY] and [HOLD].

6 Press **[F1]**.

The reception method is set and the transceiver exits from Set mode.

Tips

- The reception method selected here is applied to [VFO Scanning], [Programmable Memory Channel Scanning] and [Memory Channel Scanning].
- The scanning restart time after BUSY (duration of signal reception) can be changed by selecting the Set mode option [SCAN] → [3 SCAN RE-START].

Memory Channel Scanning

The memory channel frequencies may be scanned in the order of the memory channel numbers.

- 1 Press the **[V/M]** key to enter Memory mode.
- 2 Rotate the DIAL to select the memory channel to begin memory scanning from.
- 3 Touch **[F MW]**.
The function menu appears on the LCD.
- 4 Touch **[SCAN]**.

Scanning (SCAN) begins and progresses toward higher memory channel numbers. When a signal is received, the decimal point blinks.

- Tips**
- Rotate the DIAL clockwise to start scanning toward higher frequencies.
 - Rotate the DIAL counterclockwise to start scanning toward lower frequencies.
 - When a signal is received during scanning, scanning stops for 5 seconds to monitor the signal on the frequency of the signal.
 - When scanning stops, the decimal point blinks and the LCD remains illuminated.
 - After receiving the signal for 5 seconds, scanning resumes.
 - Press **[STOP]** to cancel scanning.

When a signal is received, the decimal point blinks.

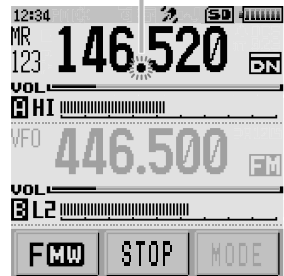

Tips

- When a memory channel is recalled, the regular memory channels (memory channel numbers 1-900) are scanned.
- When a memory bank is recalled, only the memory channels in the memory bank are scanned.
- To set the transceiver operation when scanning stops, see "Setting the Receive Operation When Scanning Stops" on page 74.
- Press and hold the **[DISP]** key for over one second to enter Set mode, then configure the following operating preference settings.
 - [CONFIG] → [3 BEEP] → [SELECT]**: Sets whether or not the beep sound is emitted when scanning stops.
 - [CONFIG] → [3 BEEP] → [EDGE]**: Sets whether or not the beep sound is emitted when the frequency band edge or memory channel 01 is reached during scanning.
 - [SCAN] → [2 SCAN LAMP]**: Sets whether or not the LCD is illuminated when scanning stops.
 - [SCAN] → [5 SCAN WIDTH]**: Sets the range of frequencies or channels to be scanned.

Specifying Skip/Selected Memory Channels

Two types of memory channels may be designated, “skip memory channels” and “specified memory channels” for effective memory channel scanning.

Skip memory channels: You can specify a memory channel you do not want to scan during memory channel scanning. Alternatively, you can specify that only designated memory channels are scanned during memory scanning.

- 1 Press the **[V/M]** key to enter Memory mode.
- 2 Rotate the DIAL to show the memory channel to register as a skip memory channel or specified memory channel.
- 3 Press and hold the **[DISP]** key for over one second.
The transceiver enters Set mode.
- 4 Touch **[MEMORY]**.





- 5 Touch **[5 MEMORY SKIP]**.



- 6 Rotate the DIAL to select **[SKIP]** or **[SELECT]**.
To register as a skip memory, select **[SKIP]**.
To register as a specified memory, select **[SELECT]**.

7 Press .

The transceiver exits from Set mode.

- Tips**
- When the channel is registered as a skip memory,  lights up.
 - When the channel is registered as a specified memory,  blinks.
 - To cancel the skip memory or specified memory setting, select [OFF] in step 6. The  on the LCD turns off and the setting is canceled.

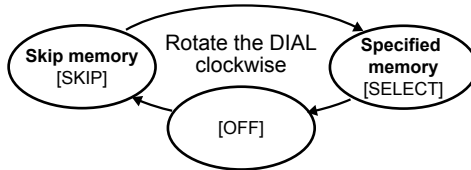



Scanning Only the Specified Memory Channels

- 1 Press the  key to enter Memory mode.
- 2 Select the memory channel registered as a specified memory channel.
- 3 Touch **[F MW]**.

The function menu appears on the LCD.

4 Touch **[SCAN]**.

- Tips**
- Rotate the DIAL clockwise to start scanning toward higher frequencies
 - Only the memory channels registered as the specified memory channels are scanned.
 - When a signal is received during scanning, a beep sound is emitted. Scanning stops for 5 seconds to monitor the channel frequency.
 - When scanning stops, the decimal point blinks and the LCD remains illuminated.
 - After receiving the signal for 5 seconds, scanning resumes.
 - Press  to cancel scanning.
 - To select the range for scanning, enter Set mode by pressing and holding the  key for over one second, then select **[SCAN]** followed by **[5 SCAN WIDTH]**.

Scanning the Memory Bank

Only the memory channels in the recalled memory bank can be scanned.

- 1 Press the **[V/M]** key to enter Memory mode.
- 2 Touch **[F MW]**.
- 3 Touch **[BANK]**.
- 4 Press the **[BAND]** key.
- 5 Rotate the DIAL to select the desired memory bank from BANK 1 to BANK 24.
- 6 Press the **[BAND]** key.
- 7 Touch **[F MW]**.
- 8 Touch **[SCAN]**.

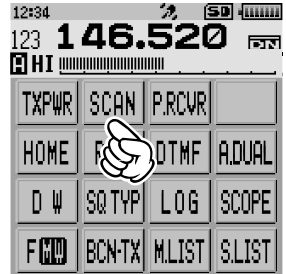

- Tips**
- Scanning is performed toward the higher memory channel numbers.
 - Rotate the DIAL clockwise: Scanning is performed toward the higher memory channel numbers. Rotate the DIAL counterclockwise: Scanning is performed toward the lower memory channel numbers.
 - When a signal is received during scanning, scanning stops for 5 seconds and this frequency is received.
 - When scanning is suspended, the decimal point blinks and the LCD stays lit.
 - After receiving the frequency for 5 seconds, scanning resumes.
 - To stop scanning, press **[STOP]**.
 - You can select the range for scanning by pressing and holding the **[DISP]** key for over one second to enter Set mode, then selecting **[SCAN]** → **[5 SCAN WIDTH]**.

Memory Bank Link Scanning

During regular memory bank scanning, only the memory channels assigned to the recalled memory bank are scanned. During memory bank link scanning, you can scan memory channels registered in two or more banks you specified in advance.

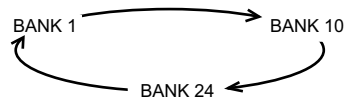

- 1 Press and hold the **[DISP]** key for over one second.
The transceiver enters Set mode.
- 2 Touch **[MEMORY]**.
- 3 Touch **[1 BANK LINK]**.
- 4 Rotate the DIAL to select the memory bank for which you want to perform bank link scanning.
- 5 Press the **[DISP]** key.
 is displayed for the selected memory bank and is displayed for unselected memory bank.
- 6 Repeat steps 4 and 5 to select other memory banks.
- 7 Press **[STOP]**.
The transceiver exits from Set mode.

Memory Channel Scanning

8 Press the **[V/M]** key to enter Memory mode.

9 Touch **[F MW]**.

10 Touch **[BANK]**.

11 Press the **[BAND]** key.

12 Rotate the DIAL to select the memory bank to begin memory scanning from.

The memory bank number is changed from [B] to [b] and the bank link scanning is activated.

The memory bank number is changed from [B] to [b]

13 Press the **[BAND]** key.

The memory banks for which you perform memory bank link scanning are determined.

14 Touch **[F MW]**.

The function menu screen appears.

15 Touch **[SCAN]**.

Tips • Scanning is performed toward the higher memory channel numbers.

- Rotate the DIAL clockwise: Scanning is performed toward the higher memory channel numbers.

- Rotate the DIAL counterclockwise: Scanning is performed toward the lower memory channel numbers.

- When a signal is received during scanning, scanning stops for 5 seconds and this frequency is received.

- When scanning is suspended, the decimal point blinks and the LCD stays lit.

- After receiving the frequency for 5 seconds, scanning resumes.

- To stop scanning, touch **[STOP]** or press **[F]**.

- You can select the range for scanning by pressing and holding the **[DISP]** key for over one second to enter Set mode, then selecting **[SCAN]** → **[5 SCAN WIDTH]**.

• Canceling Bank Link Scanning

1 Press and hold the **[DISP]** key for over one second.

The transceiver enters Set mode.

2 Touch **[MEMORY]**.

3 Touch **[1 BANK LINK]**.

4 Rotate the DIAL to select the memory bank.

5 Press the **[DISP]** key.

The memory bank display is changed from to and the bank link scanning is deactivated.

6 Repeat steps 4 and 5 to select other memory banks.

7 Press **[F]**.

The transceiver exits from Set mode.

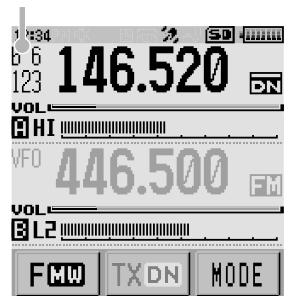

Programmable Memory Channel Scan (PMS)

Registering to the Programmable Memory Channels

50 sets of PMS memory channels (L1/U1 to L50/U50) are available.

To specify a range of frequencies to scan, register the lower limit frequency to a memory channel L1 to L50 and the upper limit frequency to a memory channel U1 to U50. Make sure to use the corresponding numbers for the lower and upper limit memory channels. PMS memory channels (L1/U1 to L50/U50) are listed after memory channel 999. Pressing the **[DISP]** key advances the memories at 100-channel increments.

For details on registering frequencies to the memory channels, see “Registering to Memory Channel” on page 55.

Cautions

- If the upper and lower limit frequencies are set in different steps, the scan width must be 100 kHz or more.
- The lower and upper limit memory channels must be within the same frequency band. Programmable memory channel scanning does not function if the frequency bands are different.

Performing Programmable Memory Channel Scan

The programmable memory channel scan allows setting a specified frequency range within the same frequency band.

- 1 Press the **[V/M]** key to enter Memory mode.
- 2 Recall the PMS memory channel to which the lower limit or upper limit of the frequency is registered.
- 3 Touch **[F MW]**.

The function menu appears on the LCD.

- 4 Touch **[SCAN]**.

Programmable memory channel scanning starts.

During scanning, “PMS” and “P*” appear.

- Tips**
- Rotate the DIAL clockwise to start scanning toward higher frequencies.
 - Rotate the DIAL counterclockwise to start scanning toward lower frequencies.
 - When a signal is received during scanning, scanning stops for 5 seconds to receive the signal on frequency.
 - When scanning stops, the decimal point blinks and the LCD remains illuminated.
 - After receiving the signal for 5 seconds, scanning resumes.
 - Touch **[STOP]** or press **[P]** to cancel scanning.
 - After scanning is canceled, press the **[V/M]** key twice to return to VFO mode.

The decimal point blinks.

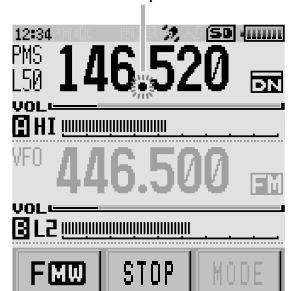

Programmable Memory Channel Scan (PMS)

Tips

- When a skip memory channel (see page 77) is registered to [L*] or [U*], or when the lower/upper limit frequency is not properly registered, program memory channel scanning does not function.
- Press and hold the **[DISP]** key for over one second to enter Set mode, then configure the following operating preference settings.

[CONFIG] → **[3 BEEP]** → **[EDGE]**: Sets whether or not the beep sound is emitted when the frequency band edge or memory channel 01 is reached during scanning.

[SCAN] → **[2 SCAN LAMP]**: Sets whether or not the LCD is illuminated when scanning stops.

What is the GM function?

The Digital GM (Group Monitor) function automatically checks on the air to find if there are other transceivers operating with the GM function on the same frequency within communication range. When other GM stations are detected, the direction, distance, and other information for each detected call sign is displayed on the LCD. This allows immediately checking the distances from the group members within the communication range and other group members.

Additionally, the GM function facilitates sending messages and images to the group members.

Caution

The GM function does not function in analog mode or on band B. Before activating GM function, Touch [MODE] to switch to the AMS (Auto Mode Select Function) or digital mode.

Tip

The GM function does not operate in analog mode. Before activating GM function, Touch [MODE] to switch to the AMS (Auto Mode Select Function) or digital mode.

Standard Operation of the GM Function

There are two methods of using the Digital GM function.

- Display all stations (up to 24 stations) operating with the GM function.
- Register IDs of friends in a group and display only registered members using the GM function.

Displaying All Stations (up to 24 Stations) Operating with the GM Function

- 1 Set the group operating frequency on band A.
- 2 Press the  key.
The group list appears.
- 3 Touch [ALL].

The ID, distance, and direction of all stations (up to 24) within the communication range operating with the GM function on the set frequency are displayed.

If there are 6 stations or more, rotate the DIAL to scroll through the displayed list.

When the GM function is active, you can confirm whether or not other stations are within communication range, and their position information with the direction and distance from your transceiver (see the following illustration).



Standard Operation of the GM Function



Example of display when ALL is selected

Registering IDs of Friends in a Group and Displaying Only Registered GM Users

Create a group with a name such as [Touring] or [Camp] and display only members registered to that group.

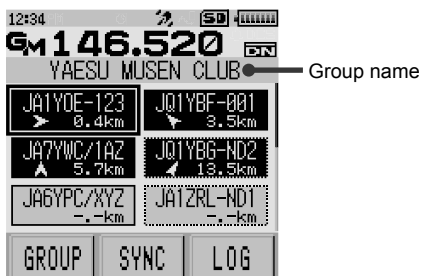

Example of display when GROUP is set

For details on how to setup a group and register members to it, refer to the GM Function Instruction Manual which is available on the Yaesu website.

Deactivating the GM Function

While operating with the GM function, press the **GM** key.

The GM function is exited and the transceiver returns to the previous operating status.

Tip

With the GM function, messages and images can be transmitted between members.

For details, refer to the GM Function Instruction Manual which is available on the Yaesu website.

The APRS (Automatic Packet Reporting System) Function

The FT2DR/DE uses a GPS receiver to acquire and display its position location information. APRS is a communication system that transmits the position information, data and messages, using the format developed by Bob Bruninga WB4APR.

Upon receiving an APRS report from a remote station, the direction and distance to the remote station from your station, the speed of the remote station, and other data sent by the remote station may be displayed on the LCD of your transceiver.



Example of display when an APRS signal is received

Setting several station parameters, such as the call sign and symbol are required before using the APRS function (initial settings).

For details, refer to the APRS Function Instruction Manual which is available on the Yaesu website.

What is the WIRES-X Function?

The WIRES-X is a system that connects to other users via the Internet. This function enables users to communicate with other users regardless of the distance.

For details, refer to the separate WIRES-X Instruction Manual which is available on the Yaesu website.

Using the GPS Function

The GPS Function

GPS (Global Positioning System) is a space-based satellite navigation system that provides location and time information anywhere on the earth. It was developed by the U.S. Department of Defense as a military system. When the GPS receiver acquires signals from 3 or more (of about 30) GPS satellites orbiting at an altitude of about 20,000 km, it can calculate and display its current position (latitude, longitude, and altitude) within a tolerance of several meters. In addition, GPS can receive the exact time from the satellite onboard atomic clock.

Activating the GPS Function

Activating the GPS function enables the transceiver to automatically obtain the internal clock setting, and your location information setting from the GPS data.

To activate the GPS function, follow the procedure below.

Tip

The default setting is ON.

- 1 Press and hold the **[DISP]** key for over one second.
The transceiver enters Set mode.

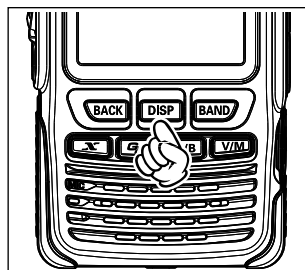

- 2 Touch **[APRS]**.



- 3 Rotate the DIAL, then touch **[20 GPS POWER]**.
- 4 Rotate the DIAL to select **[GPS ON]**
- 5 Press **[P]**.
The GPS function is activated, and the transceiver exits from Set mode.

Tips

- Your position information provided by GPS can be registered to 10 memory channels (P1 to P10). For details, refer to the APRS Function Instruction Manual. The registered position information can be set as the position of your station.
- When the GPS function is active, the power consumption increases by about 30 mA. As a result, the battery life is reduced by about 20% compared to when the GPS function is deactivated.
- To use the GPS function during APRS operation, be sure to enter Set mode by pressing and holding the **[DISP]** key for over one second, then set **[APRS] → [24 MY POSITION]** to **[GPS]**.

Method of Positioning by GPS

Displaying Position Information of Remote Stations in Digital Mode

With V/D mode of the C4FM digital, the GPS position information is transmitted simultaneously with voice signals; therefore the direction and position of the remote station can be displayed in real-time even while communicating.

For details, see “Real-Time Navigation Function” on page 93.

Tip

Even if the GPS function of your station is set to OFF, the position information of the remote station can be displayed in V/D mode.

Caution

When the GPS function is not active, the remote station cannot display the position information for your station.

About Positioning by GPS

“Positioning” refers to calculation of your current position from the satellite orbit information and radio propagation time. At least 3 satellites need to be acquired for successful positioning. If positioning fails, move away from buildings as far as possible and stand in an area with open sky.

● About errors

The measurement environment may result in positioning errors of several hundred meters. Under favorable conditions, positioning can be performed successfully using only three satellites. However, under the following poor conditions, the positioning accuracy can decrease or positioning can fail.

- Between tall buildings
- Narrow paths between buildings
- Indoors or in close proximity to large buildings
- Under elevated roads or high voltage power lines
- Between trees such as in forests or woods
- Inside a tunnel or underground
- Through heat reflective glass
- Areas with strong magnetic fields

● When not in use for a long time

When using the GPS functions for the first time after purchase, or when it has been unused in a while, a few minutes may be required to acquire the satellites. Also, if the GPS function has been turned off for several hours, a few minutes may be required to search for satellites.

Saving GPS Information (GPS Log Function)

The GPS position information can automatically be saved periodically onto a microSD memory card. Using the saved data, tracks can be displayed on commercially available map software*.

* Technical support for the map software is not provided by YAESU.

- 1 See “Activating the GPS Function” on page 86, and activate the GPS function.
- 2 Press the **[DISP]** key for over one second.
The transceiver enters Set mode.
- 3 Touch **[CONFIG]**.



- 4 Touch **[6 GPS LOG]**.



- 5 Rotate the DIAL to select the GPS data logging interval.
The selectable setting values are as follows. When OFF is set, the position information is not saved.
OFF / 1 sec / 2 sec / 5 sec / 10 sec / 30 sec / 60 sec
- 6 Press **[PWR]**.
The GPS log function is activated, and the transceiver exits from Set mode.

Tip

The position information is saved periodically unless “OFF” is selected in step 5 (shown above) or the power of the transceiver is turned off.
Reselecting the GPS data logging interval in step 5 or turning on the transceiver again, begins saving the GPS data under a different file name.

Checking Tracks on Your PC

- 1 Turn off the transceiver.
- 2 Remove the microSD memory card from the transceiver.
- 3 Connect the microSD memory card to your PC using a commercially available memory card reader.
- 4 Open the “FT2D” folder in the microSD memory card.
- 5 Open the “GPSLOG” folder.

The data is saved as “GPSyymmddhhmmss.log”.

The [yymmddhhmmss] part of the name consists of year (yy), month (mm), day (dd), hour (hh), minute (mm), and second (ss).

Tips

- Tracks can be displayed on the map by importing the data to commercially sold map software.
- For information on importing, please refer to the operation manual for the map software you use.

GPS Screen Information and Operation

Activating the GPS function displays the following information on the LCD.



- ① Displays the satellite azimuth and elevation angles. Displays in North-up mode.
- ② Displays the date and time.
- ③ Displays the current speed.
- ④ Displays the satellite number and reception level.
- ⑤ Displays the latitude on the upper side of the screen whereas displays the longitude on the lower side of the screen.

The current position appears using north (N) or south (S) latitude.

Display format: X DD° MM. MMM

X: X=N: North latitude, X=S: South latitude, DD: Degree, MM:MMM Minute

Example: N 35° 38.250 (35 degrees, 38 minutes, 15 seconds north latitude)

The current position appears using east (E) or west (S) longitude.

Display format: X DDD° MM. DMMM

X: X=E: East longitude, X=W: West longitude, DDD: Degree, MM:MMM Minute

Example: E 139° 42.500 (139 degrees, 42 minutes, 30 seconds east latitude)

- ⑥ Displays the altitude of the current position "ALTI xxxm".

Example: ALTI 20m

Displaying the GPS Information

Follow the steps below to display the GPS information.

- 1 Press the **[DISP]** key.
Displays the navigation screen.
- 2 Touch the compass on the screen.
The GPS data is displayed.

Tips

- The GPS data units for position, speed and altitude may be changed by pressing and holding the **[DISP]** key for over one second to enter Set mode, then select **[APRS] → [22 GPS UNIT]**.
- When the GPS function is used, the accurate time and date are obtained from GPS and shown on the LCD in 24-hour format. This time data is displayed on the GPS and APRS screens.
- The geodetic system datum (WGS-84 / Tokyo) of the built-in GPS unit may be changed by selecting **[APRS] → [19 GPS DATUM]** in Set mode. However, since APRS uses the geodetic system of WGS-84, it is recommended not to change it.
- The time zone may be set at 30-minute increments by pressing and holding the **[DISP]** key for over 1 second to enter Set mode, then selecting **[APRS] → [28 TIME ZONE]** (the default setting: UTC 0:00).
- When the GPS function is active, the power consumption increases by about 30 mA. As a result, the battery life is reduced by about 20% compared to when the GPS function is deactivated.
- The position information obtained from an external GPS device may be used by pressing and holding the **[DISP]** key for over one second to enter Set mode, then selecting **[APRS] → [17 COM PORT SETTING]** and then setting **[INPUT]** to **[GPS]**. In this case, the data from the internal GPS will be ignored.
- When using an external GPS device, move it away from the transceiver to reduce interference.

Smart Navigation Function

There are 2 methods of navigation with the Smart Navigation function.

- Real-time navigation function
- Backtrack function

Caution

Before using the smart navigation function, press and hold the **[DISP]** key for over one second to enter Set mode, then from **[DISPLAY]** → **[1 TARGET LOCATION]**, select **[COMPASS]**.

Real-Time Navigation Function

GPS position information and voice signals are simultaneously transmitted in the V/D mode of C4FM digital. For this reason, the position and direction of the remote station can be displayed in real time even during communication.

- 1 Press the **[DISP]** key.

The navigation screen appears.

- 2 Touch **[YR]**.

The distance and direction to the remote station operating on the same frequency in the V/D mode are displayed.



Distance to remote station

Direction display

- 3 Press the **[DISP]** key.

The screen returns to the normal frequency display.

Backtrack Function

By registering the point such as the departure point in advance, the distance and direction to the registered point from your current position can be displayed in real time.

Registering Your Current Position (Departure Point) (up to 3 Positions can Be Registered)

- 1 Press the **[DISP]** key.

The back track screen appears.

Smart Navigation Function

2 Touch [MY].

Your location information is displayed.



3 Touch [MEM].

[★], [L1] and [L2] blink.



4 Touch one of the blinking indicators to which you want to register the position information.

The location information is registered with the selected indicator, and the screen returns to the back track screen.



5 Press the [DISP] key.

The screen returns to the normal frequency display.

Using the Back Track Function

1 Press the [DISP] key.

The back track screen appears.

2 Touch the indicator ("★", "L1" or "L2") to which you want to register the location information for back tracking.

The registered position (departure point) is in the direction of the arrow within the circle. Follow the arrow so that the arrow stays pointing up on the screen.



3 Press the **[DISP]** key.

The screen returns to the normal frequency display. To confirm the position again, press the **[DISP]** key to display the back track screen.

Description of the BACK TRACK Function Screen

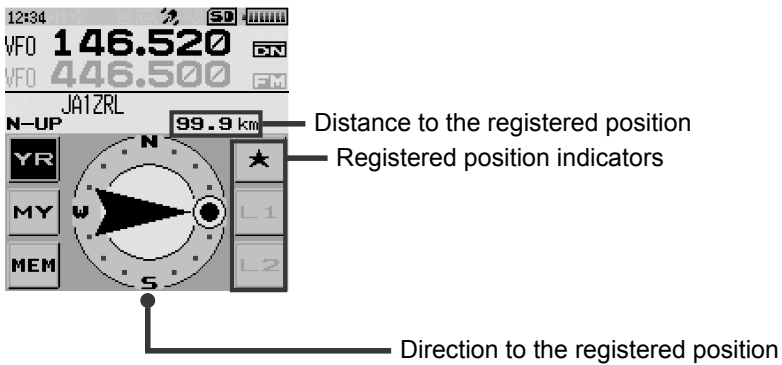

Dual Receive (DW) Function

The transceiver is equipped with the following 3 types of Dual Receive Functions:

- VFO Dual Receive
- Memory Channel Dual Receive
- Home Channel Dual Receive

The transceiver checks signals over the frequency registered to the selected memory channel (Priority Memory Channel) once approximately every 5 seconds. When the transceiver detects signals, it starts signal reception on the selected memory channel.

While receiving a signal on the frequency registered to a priority memory channel, pressing  disables the Dual Receive function and allows transmission over the same frequency.

Example: Checking the priority memory channel “90” (446.500 MHz), while receiving “146.520 MHz”

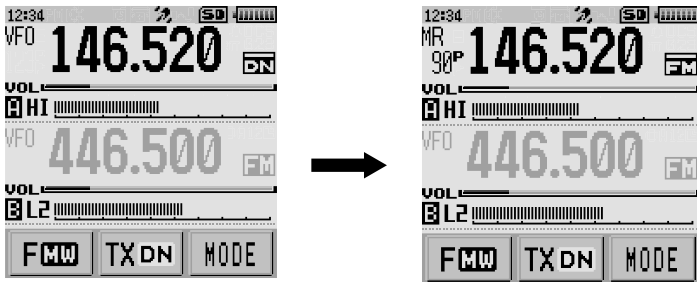

Frequency being received

The transceiver monitors signals on the frequency registered to the Priority Memory Channel “90” (446.500 MHz), once approximately every 5 seconds.

When the transceiver receives a signal on the frequency registered to the priority memory channel “90”, dual reception stops and signal receiver switches to “90” (446.500 MHz).

VFO Dual Receive

VFO mode → Priority memory channel

- 1 Press the **[V/M]** key to enter Memory mode.

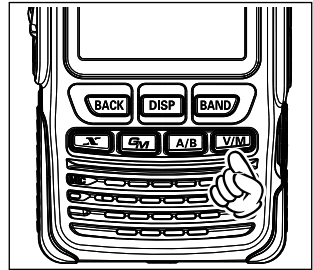

- 2 Touch **[F MW]** for over one second.
The memory registration mode is enabled, and the channel number blinks.
- 3 Rotate the DIAL to select the desired memory channel.
- 4 Touch **[PRI.CH]**.
The memory channel to preferentially receive (Priority Memory Channel) is selected. The “P” appears on the LCD.



- 5 Press the **[V/M]** key to enter VFO mode.
- 6 Select the frequency you want to constantly monitor.
- 7 Touch **[F MW]**.
- 8 Touch **[DW]**.
The Dual Reception starts and “VDW” appears on the LCD.

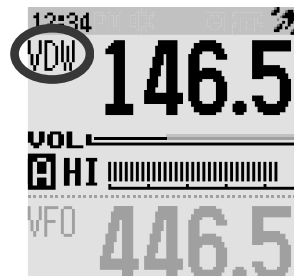

- 9 Touch **[STOP]**.
The Dual Reception is canceled.

Memory Channel Dual Receive

Memory channel → Priority memory channel

- 1 Press the **[V/M]** key to enter Memory mode.
- 2 Touch **[F MW]** for over one second.
The memory registration mode is enabled, and the channel number blinks.
- 3 Rotate the DIAL to select the desired memory channel.
- 4 Touch **[PRI.CH]**.
The memory channel to preferentially receive (Priority Memory Channel) is selected. The “P” appears on the LCD.
- 5 Select the memory channel you want to constantly receive.
- 6 Touch **[F MW]**.
- 7 Touch **[DW]**.
The HOME Channel Dual Reception starts and “MDW” appears on the LCD.



- 8 Touch **[STOP]**.
The Memory Channel Dual Receive is canceled.

Home Channel Dual Receive

Home channel → Priority memory channel

- 1 Press the **[V/M]** key to enter Memory mode.
- 2 Touch **[F MW]** for over one second.
The memory registration mode is enabled, and the channel number blinks.
- 3 Rotate the DIAL to select the desired memory channel.
- 4 Touch **[PRI.CH]**.
The memory channel to preferentially receive (Priority Memory Channel) is selected. The “P” appears on the LCD.
- 5 Touch **[F MW]**.
The function screen appears.

- 6 Touch **[HOME]**.
The HOME channel is recalled.

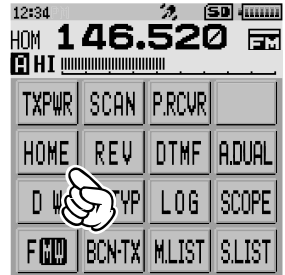

- 7 Touch **[F MW]**.
8 Touch **[DW]**.
The HOME Channel Dual Receive starts and “HDW” appears on the LCD.

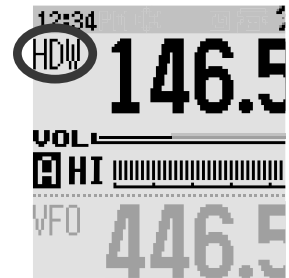

- 9 Touch **[STOP]**.
The HOME Channel Dual Receive is canceled.

Tips

- The Priority Memory Channel is set to the Memory Channel number 1 by default.
- Press and hold the **[DISP]** key for over one second to enter Set mode, then configure the following settings for more convenient use.
 - [SCAN]** → **[1 DW TIME]**: The time interval for monitoring the Priority Memory Channel can be changed.
 - [SCAN]** → **[4 SCAN RESUME]**: The resumption conditions for Dual Receive can be changed.
- The combination of the frequency bands and modes for the Priority Memory Channel and the frequency for constant signal reception can be freely changed.

AF-DUAL Receive Function (Receiving Signals on Other Frequency Channels While Listening to Broadcast Radio)

The AF-DUAL Receive Function allows reception of a radio broadcast during standby reception of A-band or B-band frequency (or frequency registered to a memory channel). When standby reception is active, no audio is heard on the standby frequency, however if a voice signal is detected, the reception of the broadcast radio will be paused, and the receiver frequency will be heard.

Dual Receive (see page 96) is a similar function. When using the Dual Receive function, every time the transceiver checks for a signal on the specified memory channel during radio reception, the radio reception is interrupted (approximately every 5 seconds). When using the AF-DUAL Receive Function, the radio reception is interrupted only when there is a calling signal from another transceiver.

Listening to a Radio Broadcast Using the AF-DUAL Receive Function

- 1 Set the A-band or B-band frequency (or Memory Channel/Home Channel) for standby receive during broadcast radio reception.

Tips • You can listen to the radio while scanning the standby receive signal frequencies.

- You can listen to the radio while monitoring the standby receive signal frequency in dual receive mode.

- 2 Press the **[A/B]** key to set the A-band to the operating band.

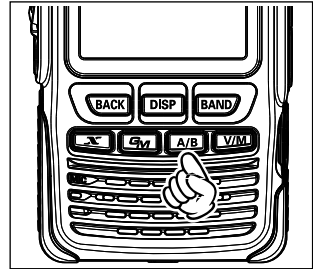

- 3 Touch **[F MW]**.
The function screen appears.

- 4 Touch **[A.DUAL]**.
The AF-DUAL function is activated.

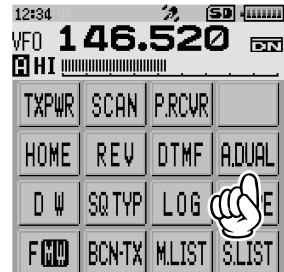

- 5 Press the **[BAND]** key to select [AM] or [WFM].

Pressing the **[BAND]** key each time switches between the AM broadcast (middle wave band) and FM broadcast.

On the LCD, AM (AM broadcast) or WFM (FM broadcast) is displayed.



- 6 Rotate the DIAL to tune to the frequency of the broadcast station.

Tips

- For broadcast station frequencies, refer to “Worldwide short wave broadcast” on page 69 or a commercially sold frequencies list.
- The AF-DUAL receive function can also be used for a radio frequency registered to a memory bank.
- Pressing **[STBY]** during radio reception allows receiving the standby frequency.
- While listening to the radio using the AF-DUAL function, in standby receive mode, the transceiver cannot simultaneously receive broadcasts on the AM frequency (middle wave band) on either the band-A or band-B, and FM frequency.
- To disable the AF-DUAL Function, touch **[F MW]** followed by **[A.DUAL]**. The frequency (memory channel) in receive standby appears on the LCD.

Setting the Resumption Time of Radio Reception

While receiving a radio broadcast, the ham radio band (A-band or B-band) can be monitored in standby receive mode. After losing the receive signal or completing transmission, broadcast reception can be resumed.

- 1 Press and hold the **[DISP]** key for over one second.
The transceiver enters Set mode.

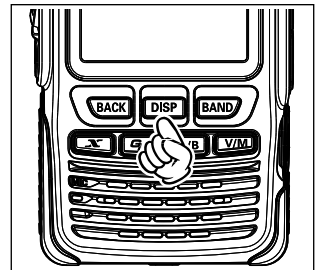

2 Touch [TX/RX].



3 Touch [3 AUDIO].

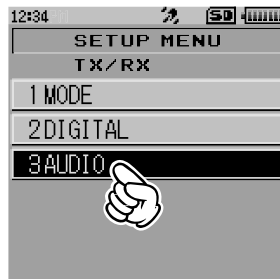

4 Touch [3 RX AF DUAL].

5 Rotate the DIAL to select the time from one of the following options for receiving radio broadcast simultaneously.

Transmission and reception for 1 second to 10 seconds/HOLD (Fixed)/
transmission for 1 second to 10 seconds

Remark The default setting: transmission and reception for 2 seconds

Display	Operation
Transmission and reception: 1 second to 10 seconds	In standby receive mode, while receiving a radio broadcast using the AF-DUAL Receive function, the ham radio stand by A-band or B-band can be received. Set the time to resume broadcast reception after losing the ham band received signal or completing a transmission. For example, set the time to 5 seconds to resume broadcast reception in 5 seconds after ham band reception (or transmission) ends.
Fixed	While receiving a radio broadcast using the AF-DUAL Receive function, the ham radio band (A-band or B-band) can be monitored in standby receive mode. If a ham band signal is received, the transceiver continuously receives the ham band frequency.
Transmission: 1 second to 10 seconds	While receiving a radio broadcast using the AF-DUAL Receive function, the ham radio band (A-band or B-band) can be received in standby receive mode. When the set resume time has passed since the transceiver completed the transmission, the transceiver returns to broadcast receive mode. If a ham band signal is received before broadcast receive is resumed, the AF-DUAL Receive function is ended and ham band receive is restored.

6 Press

The radio broadcast reception time is set, and the transceiver exits the Set mode.

Using the DTMF Function

DTMF (Dual Tone Multi Frequencies) are the tone signals sent to make telephone calls, or control repeaters and network links. Up to 10 registers of 16-digit DTMF tone codes can be stored as telephone numbers to make calls through the public telephone network using a phone patch.

Setting the DTMF Memory

- 1 Press and hold the **[DISP]** key for over one second.
The transceiver enters Set mode.
- 2 Touch **[SIGNALING]**.



- 3 Touch **[5 DTMF SELECT]**.

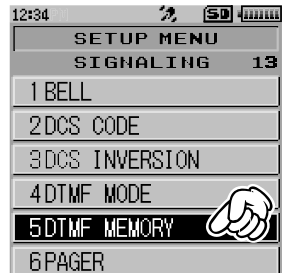

- 4 Rotate the DIAL to select the desired channel (1 to 10) to register the DTMF code, then press the **[DISP]** key.

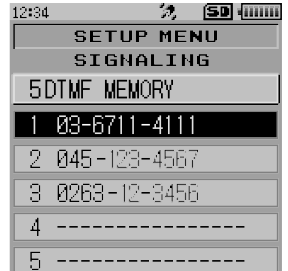

Using the DTMF Function

- 5 Input the DTMF code using the numeric keypad.

Tip Up to 16 characters (including symbols) can be input as a DTMF code.







- 6 Press .

The DTMF code is set, and the transceiver exits from Set mode.

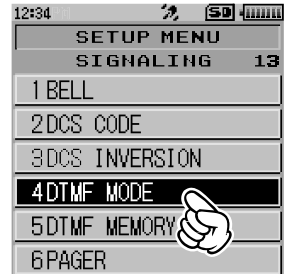
Transmitting the Registered DTMF Code

- 1 Press and hold the  key for over one second.
The transceiver enters Set mode.
- 2 Touch **[SIGNALING]**.
- 3 Touch **[4 DTMF MODE]**.



- 4 Rotate the DIAL to select **[MODE]**, then press the  key.
- 5 Rotate the DIAL to select **[AUTO]**.
- 6 Press .
- The auto dialer is enabled.
- 7 Press .
- Displays **[DTMF]**.
- 8 While pressing and holding , touch **[DTMF]**.
Displays the numeric keypad screen.
- 9 Use the numeric keypad to input the channel number of the DTMF memory you want to transmit.

Tips

- The registered DTMF code is transmitted.
- The transmitted DTMF audio can be heard from the speaker.

- 10 Release .

Even after releasing , the transmission continues until the DTMF code transmission is completed.

Manually Transmitting the DTMF Code

- 1 Press and hold the **[DISP]** key for over one second.
The transceiver enters the Set mode.
- 2 Touch **[SIGNALING]**.
- 3 Touch **[4 DTMF MODE]**.
- 4 Rotate the DIAL to select **[MODE]**, then press the **[DISP]** key.
- 5 Rotate the DIAL to select **[MANUAL]**.
- 6 Press **[F1]**.
The transceiver is ready for transmitting the DTMF code manually.
- 7 Press **[F1]**.
[DTMF] appears on the LCD.
- 8 While pressing **[F1]**, touch **[DTMF]**.
The numeric keypad appears.
- 9 Use the numeric keypad to input the DTMF code.
Tips
 - The registered DTMF code is transmitted (Refer to the following table).
 - The transmitted DTMF sound can be heard from the speaker.
- 10 Release **[F1]**.
Even after releasing **[F1]**, the transmission continues until the DTMF signal transmission is completed.

Tip

The DTMF code is a combination of 2 frequencies.

	1209Hz	1336Hz	1477Hz	1633Hz
697Hz	1	2	3	A
770Hz	4	5	6	B
852Hz	7	8	9	C
941Hz	*	0	#	D

Spectrum Analyzer with Signal Strength Graph Band Scope Function

The Spectrum Analyzer presents a view of operating activity on channels above and below the current main band operating frequency as the center (marked with ▼).

- 1 Rotate the DIAL to tune in to the desired center frequency.
- 2 Touch **[F MW]**.
Touch **[SCOPE]**.

With the current frequency in the center, the signal strengths of 35 channels (+/-16 channels) bandwidth are shown on a graph.

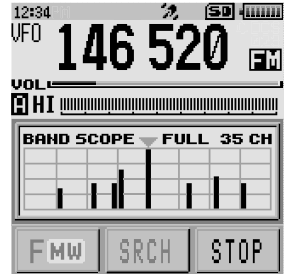

- 3 Rotate the DIAL to move ▼ to a signal.
The signal at the center of the displayed graph becomes the operating frequency.
- 4 Touch **[STOP]**.
The band scope scanning stops.
Tip To resume band scope scanning, touch **[SRCH]**.
- 5 Press the **[BACK]** key.

Tips

- Press and hold the **[DISP]** key for over one second to enter Set mode, then select **[DISPLAY]** → **[3 BAND SCOPE]**. The number of band scope channels can be changed to 17 or 71.
- The band scope channel interval is the same as the VFO frequency step.
- When band scope is active, the numeric keypad does not function.
- The audio of A/B common frequency band can be heard while scanning.
- There are 2 ways for scanning (scoping) as follows.
FULL: Continuously scans (scopes).
1Time: Scans (scopes) only once. Changing the frequency with the DIAL resumes scanning.
* In analog mode, only FULL is selected.
* In digital mode, only 1Time is selected.

Taking Picture Using the Optional Camera-Mounted Speaker Microphone Snapshot Function

Pictures can be taken by connecting the optional camera-mounted speaker microphone (MH-85A11U).



Captured image data can be saved onto a microSD memory card inserted in the transceiver.

The saved data can be displayed on the screen and transmitted to other transceivers* as well.

In addition, the most recently captured image data can be transmitted to other transceivers* by pressing  (Send Image Button) on the camera-mounted speaker microphone.

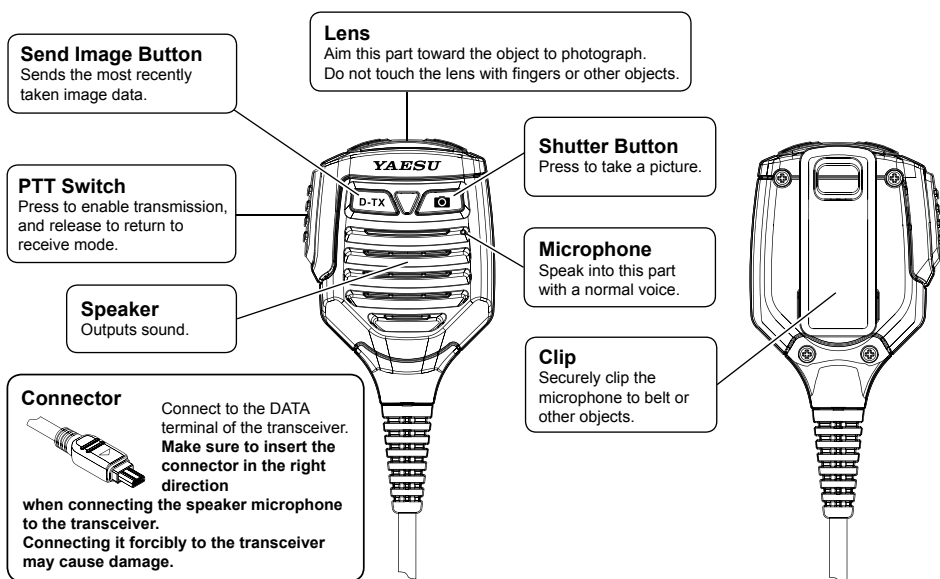

* Refer to the Yaesu website or catalog for the transceiver models to which images can be transferred.



- 1 Press and hold  for over one second to turn off the transceiver.
- 2 Connect the camera-mounted speaker microphone (MH-85A11U) to the transceiver.
Tip Connect the connector to the DATA terminal of the transceiver.
- 3 Press and hold  for over one second to turn on the transceiver.

Caution

When receiving an AM radio broadcast signal with the camera microphone connected, noise may occur, but this is not a malfunction.

- 4 Press .
- Aim the lens toward the object, then press .
- Make sure to keep at least 50 cm distance between the lens and the object. If the object is too close, the picture will be out of focus, resulting in a blurred picture.

- Tips**
- Press and hold the **[DISP]** key for over one second to enter Set mode, then select **[OPTION]** → **[1 USB CAMERA]**, you can set the picture size (resolution) and image quality (compression rate).
 - Captured images are saved onto the microSD memory card inserted in the transceiver.
 - If your station and the remote station are both in digital mode, you can transfer the image data most recently taken by pressing **[D-TX]**.

Cautions

- Do not directly photograph objects with strong light, such as the sun or other bright objects. Doing so can cause malfunction.
- If the lens or the microphone gets dirty, use a dry, soft cloth to wipe off the contaminants.
- Do not place the MH-85A11U near heat emitting equipment or where it is exposed to direct sunlight. Doing so can cause fire or a malfunction.
- Be careful not to drop the MH-85A11U. Applying a strong shock may result in damages or failure.

The captured image appears on the LCD.

- 5 To save the image onto the microSD memory card, touch **[SAVE]**.
Press the **[BACK]** key or touch **[DEL]** returns the display to the previous operating screen without saving the image.
- 6 After saving the image, to transmit the image to other transceivers, touch **[SEND]**.
- 7 Touch **[OK]** to return the display to the previous operating screen.

Viewing the Saved Image

- 1 Touch **[F MW]** on the normal operation screen.
- 2 Touch **[LOG]**.
- 3 Touch **[PICT]**.
Displays the saved image data list.
- 4 Touch the image you want to display.
Displays the selected image.
- 5 Press the **[BACK]** key 3 times to return to the previous operating screen.

Transmitting the Saved Image to Other Transceivers

- 1 Touch **[F MW]** on the normal operation screen.
- 2 Touch **[LOG]**.
- 3 Touch **[PICT]**.
Displays the saved image data list.
- 4 Touch the image you want to transmit.
Displays the selected image.
- 5 Touch **[SEND]** or **[FWD]**.
Starts transmission. When transmission completes, the screen returns to the screen in step 3.
- 6 Press the **[BACK]** key twice to return to the previous operating screen.

Using the Tone Squelch Function

The tone squelch opens the speaker audio only when a signal containing the specified CTCSS tone is received. Using the digital code squelch (DCS) opens the speaker audio only when a signal containing the specified DCS code is received. When the tone squelch function is active, signals from other stations not containing the specified code are not heard. The receiver will be quiet while waiting for a call from a specific station over a long period of time.

Cautions

- The tone squelch function does not function in digital mode. Touch **[MODE]** to switch the communication mode to AMS (Automatic Mode Select Function) or analog mode in advance.
- The tone squelch function does not function when the APRS baud rate is set on B-band. In Set mode, select **[APRS]** → **[4 APRS MODEM]**, then switch the setting to OFF in advance.

Selecting the Squelch Type

- 1 Press and hold the **[DISP]** key for over one second.
The transceiver enters Set mode.

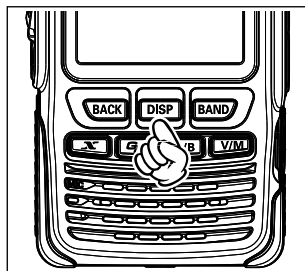

- 2 Touch **[SIGNALING]**.



- 3 Touch **[11 SQL TYPE]**.
- 4 Rotate the DIAL to select the desired squelch type.
- 5 Press **[F7]**.
The selected squelch type is set and the transceiver exits from Set mode.

Using the Tone Squelch Function

Tips

- The squelch type can be set for each frequency band on both A-band (Main) and B-band (Sub).
- The CTCSS and DCS squelch settings are also active during scanning. If scanning is performed with the CTCSS and DCS squelch function activated, scanning stops only when a signal containing the specified CTCSS tone or DCS code is received.
- Pressing the Monitor switch allows signals that do not contain a tone or DCS code, and signals with different tones or DCS codes to all be heard.
- Pressing and holding the **[DISP]** key for over one second to change the Set mode option allows you to use this function more conveniently.
[SIGNALING] → **[3 DCS INVERSION]**: Allows you to receiving the DCS code of the inverted phase.
[SIGNALING] → **[10 SQL EXPANSION]**: Allows specifying squelch types for transmit and receive respectively.

Display	Operation
OFF	Deactivates transmit/ receive tone squelch function, etc.
TONE	Activates CTCSS transmit tones ([TN] appears).
TONE SQL	Activates the tone squelch receive function ([TSQ] appears).
DCS	Activates the digital code squelch ([DCS] appears).
REV TONE	Activates the reverse tone ([RTN] appears). Use to monitor communications based on the squelch control system in which a tone signal is contained when communication is not performed and the tone signal disappears when communication starts.
PR FREQ	Activates the no-communication squelch function for radios ([PR] appears). You can specify no-communication signal tone frequencies within the range from 300 Hz to 3000 Hz in steps of 100 Hz.
PAGER (see page 116)	Activates a new pager function ([PAG] appears). When communicating via transceivers with your friends, specify personal codes (each code is composed of two tones) so that you can call only specific stations.
D CD*	Sends a DCS code only for transmission ([DC] appears).
TONE-DCS*	Sends a tone signal when transmitting, and waits for a DCS code when receiving ([T-D] appears).
D CD-TONE SQL*	Sends a DCS code when transmitting, and waits for a tone signal when receiving ([D-T] appears).

*: Press and hold the **[DISP]** key for over one second, then set **[SIGNALING]** → **[10 SQL EXPANSION]** to ON. The setting options for D CD, TONE-DCS and D CD TONE SQL are added to the **[SIGNALING]** → **[11 SQL TYPE]** in Set mode. This allows specifying the squelch types for transmit and receive respectively.

Setting the Tone Frequency

The tone frequency can be selected from 50 frequencies (from 67.0 Hz to 254.1 Hz).

- 1 Press and hold the **[DISP]** key for over one second.
The transceiver enters Set mode.
- 2 Touch **[SIGNALING]**.
- 3 Rotate the dial, then touch **[12 TONE SQL FREQ]**.

- 4 Rotate the dial to select the desired tone frequency.



- 5 Gently press the **BACK** key 3 times.

The selected tone frequency is set and the transceiver exits from Set mode.

Tips

- The tone frequency set by following the procedure above is also effective when tones are only transmitted.
- The default setting is 100 Hz.

Searching for the CTCSS Tone transmitted by the Remote Station

Search and display the tone squelch CTCSS tone transmitted by the remote station.

- 1 Press and hold the **DISP** key for over one second.
The transceiver enters Set mode.
- 2 Touch **[SIGNALING]**.
- 3 Rotate the DIAL, then touch **[11 SQL TYPE]**.
- 4 Rotate the DIAL to select **[TONE SQL]**.
- 5 Press the **BACK** key.
- 6 Rotate the DIAL, then touch **[12 TONE SQL FREQ]**.
- 7 Receive the signal from the remote station.
- 8 Touch **[SRCH]**.

The transceiver begins searching for a matching tone frequency

When a corresponding tone frequency is detected, a beep sound is emitted and searching stops temporarily. The detected tone frequency blinks.

- Tip** To set CTCSS to the detected tone frequency,
Touch **[STOP]**. → Hear the beep sound. → Gently press the **BACK** key 3 times.
The transceiver exits from Set mode.

Tip

To set the transceiver operation when scanning stops, see "Setting the Receive Operation When Scanning Stops" on page 74.

Setting the DCS Code

The DCS code can be selected from 104 types (from 023 to 754).

- 1 Press and hold the **[DISP]** key for over one second.
The transceiver enters Set mode.
- 2 Touch **[SIGNALING]**.
- 3 Touch **[2 DCS CODE]**.

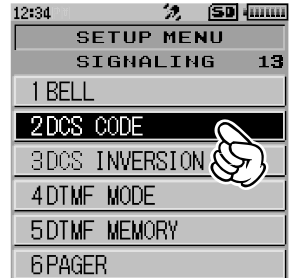

- 4 Rotate the DIAL to select the desired DCS code.



- 5 Gently press the **[BACK]** key 3 times.
The DCS code is set and the transceiver exits from Set mode.

Tip

The default setting is [023].

Searching for the DCS Code Used by the Remote Station

Search and display the DCS code used by the remote station.

- 1 Press and hold the **[DISP]** key for over one second.
The transceiver enters Set mode.
- 2 Touch **[SIGNALING]**.
- 3 Touch **[2 DCS CODE]**.

4 Touch [SRCH].

[DCS SEARCH] appears on the LCD.

The transceiver starts to search for the DCS code.

When a corresponding DCS code is detected, a beep is emitted and searching stops temporarily. The detected DCS code blinks.

Tip To stop searching, touch [STOP].

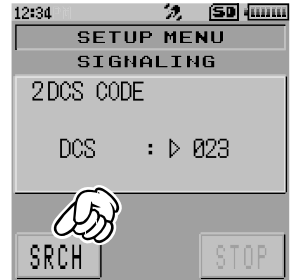

Tip To set the searched DCS code,

Touch [STOP]. → Hear the beep sound. → Gently press the [BACK] key 3 times.
The transceiver exits from Set mode.

Tip

For setting how the transceiver operates when scanning stops, see “Setting the Receive Operation When Scanning Stops” on page 74.

Notification of a Call from a Remote Station by Vibration

Set the vibrator to alert you of a call from a remote station containing a corresponding tone or DCS code.

1 Press and hold the [DISP] key for over one second.

The transceiver enters Set mode.

2 Touch [CONFIG].



3 Touch [22 VIBRATOR].

4 Rotate the DIAL to select [MODE], then press the [DISP] key.

5 Rotate the DIAL to select [SIGNALING].



6 Press [OK].

The vibrator setting is set and the transceiver exits from the Set mode.



Tip To deactivate the vibrator function, select [OFF] in step 5.

Using the Tone Squelch Function

Tips

- The vibrator can function for all frequency bands belonging to A-band (Main) and B-band (Sub).
- If you select [BUSY] in step 5, when the transceiver receives a signal, BUSY LED and the vibration function turn on simultaneously regardless of the communication mode or squelch type.
- The vibrator functions when the vibrator setting is other than OFF. Press  to perform transmission, and release  to deactivate the vibrator for 5 seconds.

Selecting the Vibrator Operation Mode

- 1 Press and hold the  key for over one second.
The transceiver enters Set mode.
- 2 Touch [CONFIG].
- 3 Touch [22 VIBRATOR], then press the  key.
- 4 Rotate the DIAL to select [SELECT], then press the  key.
- 5 Rotate the DIAL to select the desired vibrator operation.

Remark The default setting: PATTERN1

PATTERN1	The vibrator functions continuously.
PATTERN2	The vibrator functions at long intervals.
PATTERN3	The vibrator functions at short intervals.

- 6 Press .
- The selected vibrator operation is set and the transceiver exits from Set mode.

Notification of a Call from a Remote Station by the Bell Function

Set the Bell sound to alert you of a call from a remote station containing a corresponding tone or DCS code.  on the LCD blinks at the same time.

- 1 Press and hold the  key for over one second.
The transceiver enters Set mode.
- 2 Touch [SIGNALING].
- 3 Touch [1 BELL].

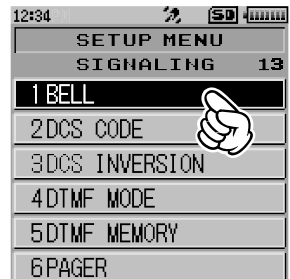

- 4 Rotate the DIAL to select **[SELECT]**, then press the **[DISP]** key.



- 5 Rotate the DIAL to select **[BELL]**.

- 6 Press **[M]**.

The Bell function is activated to on and the transceiver exits from Set mode.

When the tone squelch or DCS code is set, **[M]** appears.

Tip To deactivate the Bell function, select **[OFF]** in step 5.

Tips

- To use the Bell function, set the tone squelch or DCS to on.
- The bell function cannot be used via the repeater.
- When the bell function is on, **[M]** appears on the LCD.
When a signal is received from a remote station, **[M]** blinks.
- When a signal is received from a remote station, **[M]** blinks.
When pressing **[M]** to perform transmission, **[M]** stops blinking and lights up.

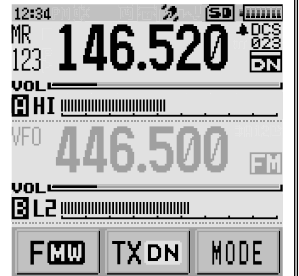

Changing the Number of Times the Bell Rings

- 1 Press and hold the **[DISP]** key for over one second.
The transceiver enters Set mode.
- 2 Touch **[SIGNALING]**.
- 3 Touch **[1 BELL]**.
- 4 Rotate the DIAL to select **[RINGER]**, then press the **[DISP]** key.
- 5 Rotate the DIAL to select the desired number of times the Bell rings.

Remark The default setting: Once

Tip You can select the number of times the bell rings from among 1 to 20 times, or continuous.

- 6 Press **[M]**.

The setting is applied and the transceiver exits from Set mode.

Calling Only a Specific Station New Pager Function

When using the transceivers with your friends, specifying personal codes (each code composed of two CTCSS tones) allows you to call just a specific station. Even when the person who is called is not near his or her transceiver, the information on the LCD indicates that a call was received.

Caution

The new pager function does not function in digital mode. Touch **[MODE]** to switch the communication mode to AMS (Automatic Mode Select Function) or analog mode in advance.

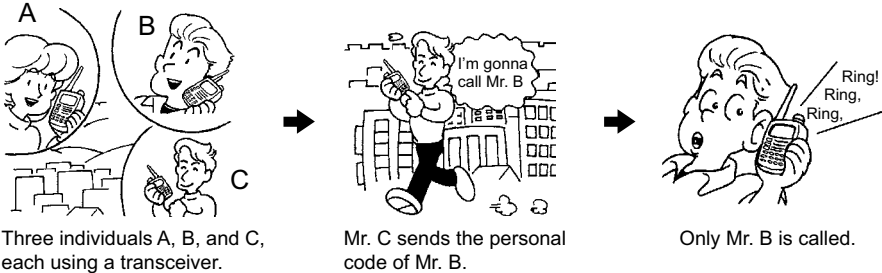

Flow of Operation to Use the Pager Function

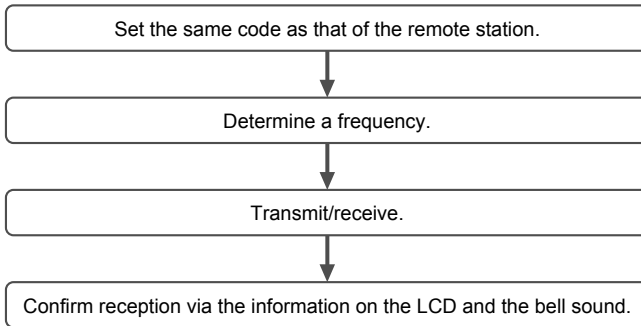

Setting the Code for Your Station

Set the personal code (your code) to be called by other stations.

- 1 Press and hold the **[DISP]** key for over one second.
The transceiver enters Set mode.
- 2 Touch **[SIGNALING]**.

- 3 Touch [6 PAGER].

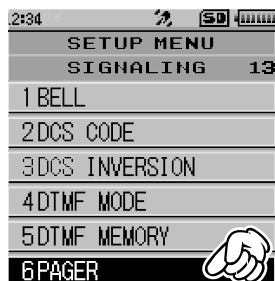

- 4 Rotate the DIAL to select [CODE-RX], then press the **[DISP]** key.
- 5 Rotate the DIAL to select the first element of the code from 1 to 50, then press the **[DISP]** key.
The cursor moves.
- 6 Rotate the DIAL to select the second element of the code from 1 to 50, then press the **[DISP]** key.
- Caution** The same code cannot be use for both elements.
- 7 Press **[M]**.

Your station code is set and the transceiver exits from Set mode.

- Tips**
- The default setting: [05 47]
 - Even if the first and second parts of your personal code are reversed, i.e., [47 05] from [05 47] they are still recognized as the same code.
 - If the same code is specified for all individuals, all the individuals can be called at the same time.

Activating the New Pager Function

- 1 Press and hold the **[DISP]** key for over one second.
The transceiver enters Set mode.
- 2 Touch [SIGNALING].
- 3 Rotate the DIAL, then touch [11 SQL TYPE].
- 4 Rotate the DIAL to select [PAGER].
- 5 Press **[M]**.
The new pager function is activated and the transceiver exits from Set mode.
You are ready to make a call, or wait for a call from a remote station, using the new pager function.

Calling a Specific Station

- 1 See “Activating the New Pager Function” on page 117to activate the new pager function.
- 2 Press and hold the **[DISP]** key for over one second.
The transceiver enters Set mode.

- 3 Touch **[SIGNALING]**.
- 4 Touch **[6 New Pager Function]**.
- 5 Rotate the DIAL to select **[CODE-TX]**, then press the **[DISP]** key.
- 6 Rotate the DIAL to select the first element of the code used by the remote station, then press the **[DISP]** key.

Caution Register the pager code of the remote station in advance.
The cursor moves.
- 7 Rotate the DIAL to select the second element of the code used by the remote station, then press the **[DISP]** key.
- 8 Press **[OK]**.
The code is set and the transceiver exits from Set mode.
- 9 Press **[OK]**.
The remote station is called.

Being Called by the Remote Station (Standby Operation)

If you turn on the Bell Function (☞ see page 114), you are alerted to a call from the remote station by the **[PAG]** display, the blinking **[▲]** icon, and the Bell sound. Also, if you turn on the vibrator function (☞ see page 113), the vibrator can alert you that you have been called by the remote station.

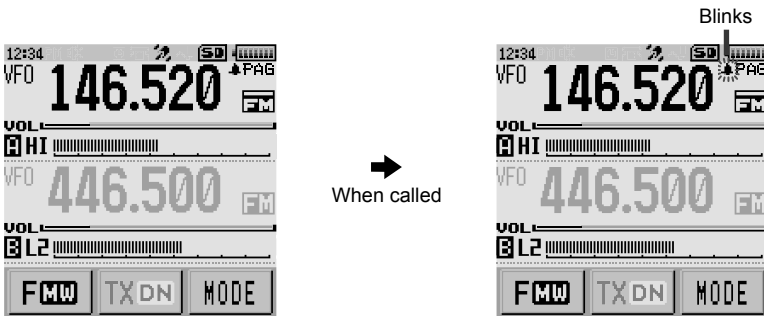

Tip Pressing and holding the **[DISP]** key for over one second, and then selecting **[SIGNALING]** → **[6 New Pager Function]** → **[ANS-BACK]** → **[ON]** in Set mode, automatically places the transceiver in transmission mode (for about 2.5 seconds) when called by the remote party, and notifies the remote party that you are ready to communicate.

Using Set Mode

Set Mode allows selecting various functions from the list and setting each function according individual preferences.

Set Mode Operation

- 1 Press and hold the **[DISP]** key for over one second.
The transceiver enters Set mode.

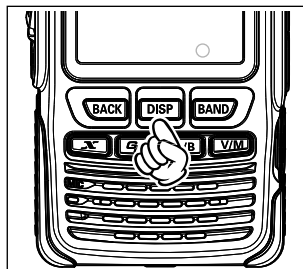

- 2 Touch the desired item in SETUP MENU.



- 3 Rotate the DIAL, then touch the desired Set mode sub-menu.

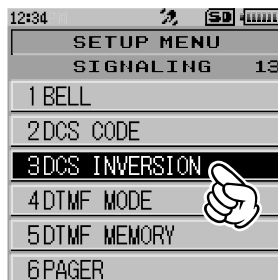

- 4 Rotate the DIAL to select the desired item to set.

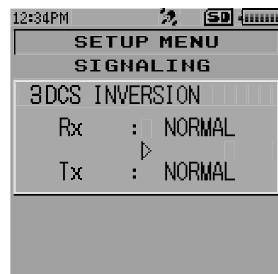

[When there is no deeper level of menu items]

Go to step 7.

[When there is deeper level of menu items]

- 5 Press the **[DISP]** key.
- 6 Rotate the DIAL to select the desired item to set.
- 7 Press **[↵]**.
Exits from Set mode.

Caution

On some setting screens, pressing **[↵]** does not exit from Set mode. In this case, press the **[BACK]** key several times to return to the frequency display screen.

Resetting the All Set Mode Settings

All the Set mode settings can be restored to the default settings by following the procedure below.

- 1 Press and hold **[⏻]** for over one second to turn off the transceiver.
- 2 While pressing the **[BACK]** and **[DISP]** keys simultaneously, press **[⏻]** for over one second.
The transceiver turns ON. When you hear a beep sound, release the keys.
- 3 After “SET MODE RESET?” appears, touch **[OK]**.
A beep sounds.

Tips • To cancel resetting, touch **[CANCEL]**.

- To reset the following items, make sure to perform All Reset (**[⏻]** see page 51).

[TX/RX]

- 1-1 ANTENNA ATT
- 1-2 HALF DEVIATION
- 1-3 RX MODE
- 2-1 SQL TYPE

[MEMORY]

- 2 BANK NAME
- 3 MEMORY NAME
- 5 MEMORY SKIP

[SIGNALING]

- 2 DCS CODE
- 3 DCS INVERSION
- 6 PAGER
- 7 PR FREQUENCY
- 9 SQL S-METER
- 11 SQL TYPE
- 12 TONE SQL FREQ

[WIRES-X]

- 1 RPT/WIRES FREQ
- 2 SEARCH SETUP
- 4 EDIT CATEGORY TAG

[CONFIG]

- 5 CLOCK TYPE
- 12 PASSWORD
- 15 RPT SHIFT
- 16 RPT SHIFT FREQ
- 18 STEP

[APRS]

- 7 APRS MSG TXT
- 15 BEACON STATS TXT
- 18 DIGI PATH
- 19 GPS SETUP
- 23 CALLSIGN (APRS)
- 24 MY POSITION
- 25 MY SYMBOL (4:User)

[CALLSIGN]

- 1 CALLSIGN (DIGITAL)

Tables of Set Mode Operations

Set mode no. / item	Description	Selectable options (Options in bold are the default settings)	Page
DISPLAY			
1 TARGET LOCATION	Set what to display using the smart navigation function.	COMPASS / NUMERIC	128
2 COMPASS	Set the compass display of the smart navigation function.	HEADING UP / NORTH UP	128
3 BAND SCOPE	Set the number of search channels for the band scope function.	17ch / 35ch / 71ch	128
4 LAMP	Set the duration time of the backlight and keys to be lit.	KEY: OFF / 2 to 10 SEC (KEY) / CONTINUOUS KEY 5Sec SAVE: ON / OFF	129
5 LANGUAGE	Switch between Japanese/English for the menus and Set mode, etc.	ENGLISH / JAPANESE	129
6 LCD CONTRAST	Set the LCD contrast level.	LEVEL 1 to LEVEL 15 LEVEL 7	129
7 LCD DIMMER	Set the brightness level of the LCD backlight and numeric keypad light.	LEVEL 1 to LEVEL 6 LEVEL 6	130
8 OPENING MESSAGE	Set the opening message type.	CALLSIGN / NORMAL / OFF / DC / MESSAGE	130
9 SENSOR INFO	Display the voltage.	Voltage	130
10 S-METER SYMBOL	Select the symbol used for the S/PO meter.	4 types	131
11 SOFTWARE VERSION	Display the software version.	Main / Sub / DSP	131
TX / RX			
1 MODE			
1-1 ANTENNA ATT	Switch the attenuator between ON/OFF.	ON / OFF	50
1-2 HALF DEVIATION	Set the transmission modulation level.	ON / OFF	132
1-3 RX MODE	Select the receive mode.	AUTO / FM / AM	48
2 DIGITAL			
2-1 SQL TYPE	Set the squelch type for digital mode.	SQL TYPE: OFF / CODE / BREAK SQL CODE: 001 to 126	133
2-2 DIGI POPUP	Set the POP UP time.	OFF / BND2s / BND4s / BND6s / BND8s / BND10s / BND20s / BND30s / BND60s / BNDCNT	133
2-3 LOCATION SERVICE	Set whether or not to display your current location in digital mode.	ON / OFF For details on the function, see the GM Function Instruction Manual.	
2-4 STANDBY BEEP	Switch the standby beep function between ON/OFF.	ON / OFF	134
3 AUDIO			
3-1 MIC GAIN	Adjust the microphone gain level.	LEVEL 1 to LEVEL 9 LEVEL 5	134
3-2 MUTE	Set the muting level on the non-operating band side when a signal is received on the operating band side.	OFF / MUTE 30% / MUTE 50% / MUTE 100%	44
3-3 RX AF DUAL	Set the resumption time of radio reception in the AF Dual mode.	Transmit and receive 1 second to 10 seconds, Fixed, or transmission 1 second to 10 seconds. Transmission 2 seconds	101

Tables of Set Mode Operations

Set mode no. / item	Description	Selectable options (Options in bold are the default settings)	Page
MEMORY			
1 BANK LINK	Set the memory bank link.	BANK 1 to BANK 24, BANK LINK ON / OFF	136
2 BANK NAME	Assign a name to each memory bank.	BANK 1 to BANK 24	64
3 MEMORY NAME	Input the memory channel tag.	Up to 16 letters	59
4 MEMORY PROTECT	Set whether to allow or prohibit memory channel registration.	ON / OFF	137
5 MEMORY SKIP	Set for skip memory / specify memory	OFF / SKIP / SELECT	77
6 MEMORY WRITE	Set the automatic channel number increment when registering to a memory channel.	NEXT / LOWER	137
SIGNALING			
1 BELL	Set the bell function settings.	SELECT: OFF / BELL RINGER: 1 time to 20 times / Continuous	114
2 DCS CODE	Set the DCS code.	023 to 754	112
3 DCS INVERSION	Select a combination of DCS inversion codes in terms of communication direction.	RX (Receive): NORMAL (Homeomorphic) / INVERT (Inversion) / BOTH (Both Phase) TX (Transmission): NORMAL (Homeomorphic) / INVERT (Inversion)	138
4 DTMF MODE	Set the transmission of DTMF code registered to a DTMF memory channel, DTMF code transmission delay time, and DTMF code transmission speed.	MODE: MANUAL / AUTO DELAY: 50ms / 250ms / 450ms / 750ms / 1000ms SPEED: 50ms / 100ms	104
5 DTMF MEMORY	Set the DTMF auto dialer channel and code (16 characters).	CH1 to CH10	103
6 PAGER	Turn the pager answerback Function ON/OFF, and specify a personal code (transmit/receive).	ANS-BACK: ON / OFF CODE-RX: 01 to 50 for each, 05 47 CODE-TX: 01 to 50 for each, 05 47	116
7 PR FREQUENCY	Set a non-communication squelch.	300Hz to 3000Hz 1600Hz	139
8 SQL LEVEL	Select a squelch level.	Level 0 to Level 15 Level 1	139
9 SQL S-METER	Select an S-Meter squelch level	OFF / LEVEL 1 to LEVEL 9	140
10 SQL EXPANSION	Set a squelch type separately for Receive and transmit.	ON / OFF	140
11 SQL TYPE	Select a squelch type.	OFF / TONE / TONE SQL / DCS / REV TONE / PR FREQ / PAGER / (D CD) / (TONE-DCS) / (DCD-TONE SQL) * The options in the parentheses are available when the SQL expansion is ON.	109
12 TONE SQL FREQ	Set a tone frequency.	67.0Hz to 254.1Hz 100Hz	110
13 TONE-SRCH	Set the audio output during tone search. Turn the muting function on/off and select a tone search speed.	MUTE: ON / OFF SPEED: FAST / SLOW	141
14 WX ALERT	Enables/Disables the Weather Alert Feature	ON / OFF	141

Tables of Set Mode Operations

Set mode no. / item	Description	Selectable options (Options in bold are the default settings)	Page
SCAN			
1 DW TIME	Set the priority memory channel monitoring interval.	0.1 SEC to 10 SEC 5.0 SEC	142
2 SCAN LAMP	Set whether or not to light up the scan lamp when scanning stops.	ON / OFF	142
3 SCAN RE-START	Set the scanning restart time.	0.1 SEC to 10 SEC 2.0 SEC	142
4 SCAN RESUME	Configure the scan stop mode settings.	SCAN: BUSY / HOLD / 2sec to 10sec 5.0sec DW: BUSY / HOLD / 2sec to 10sec	74
5 SCAN WIDTH	Set the scan mode operation	VFO: ALL / BAND MEMORY: ALL CH / BAND	143
GM			
1 DELETE GROUP	Delete a registered group.	-	-
2 DELETE MEMBER	Delete a registered member.	-	-
3 RADIO ID	Display the transceiver specific number (ID). (Uneditable)	-	-
* For details of the functions, refer to the GM Function Instruction Manual.			
WIRES-X			
1 RPT/WIRES FREQ	Set the frequency to be used for Repeater/WIRES.	MANUAL / PRESET	-
2 SEARCH SETUP	Set the WIRES ROOM selection method.	HISTORY / ACTIVITY	-
3 EDIT CATEGORY TAG	Edit category tags.	C1 to C5	-
4 REMOVE ROOM/ NODE	Delete registered Category ROOMs.	C1 to C5	-
* For details of the functions, refer to the WIRES-X Instruction Manual.			
CONFIG			
1 APO	Set the length of time until the transceiver turns off automatically.	OFF / 0.5 HOUR to 12 HOURS	145
2 BCLO	Turn on/off the busy channel lockout function.	ON / OFF	145
3 BEEP	Set the beep emitting function, and set whether or not to emit the beep sound when a band edge/CH1 is encountered.	SELECT: KEY&SCAN / KEY / OFF EDGE: OFF / ON	146
4 BUSY LED	Turn on/off the BUSY indicator.	A BAND: ON / OFF B BAND: ON / OFF RADIO: ON / OFF	146
5 CLOCK TYPE	Set the clock shift function.	A / B	147
6 GPS LOG	Set the GPS log recording time interval.	OFF / 1 SEC / 2 SEC / 5 SEC / 10 SEC / 30 SEC / 60 SEC	147
7 HOME VFO	Enable/disable VFO transmission in Home Channel.	ENABLE / DISABLE	147
8 LED LIGHT	Set whether or not to turn on the light when the [DISP] key is pressed.	-	147
9 LOCK	Configure the lock mode setting.	KEY&DIAL / PTT / KEY&PTT / DIAL&PTT / ALL / KEY / DIAL	148
10 MONI/T-CALL	Select the function of the  switch.	MONI / T-CALL	148

Tables of Set Mode Operations

Set mode no. / item	Description	Selectable options (Options in bold are the default settings)	Page
11 TIMER	Switch the timer between ON and OFF.	ON: 00:00 to 23:59 ☒ / ☐ OFF: 00:00 to 23:59 ☒ / ☐	149
12 PASSWORD	Input the password.	OFF / [****]	149
13 PTT DELAY	Set the PTT delay time.	OFF / 20ms / 50ms / 100ms / 200ms	150
14 RPT ARS	Turn the ARS function on/off.	ON / OFF	150
15 RPT SHIFT	Set the repeater shift direction.	SIMPLEX / -RPT / +RPT	150
16 RPT SHIFT FREQ	Set the repeater shift width.	0.000MHz to 150.000MHz	151
17 SAVE RX	Set the receive save time.	OFF / 0.2 SEC (1:1) to 60.0 SEC (1:300)	151
18 STEP	Set the channel step.	AUTO / 5.0KHz / 62.5KHz / 8.33KHz / 9.0KHz / 10.0KHz / 12.5KHz / 15.0KHz / 20.0KHz / 25.0KHz / 50.0KHz / 100KHz	47
19 DATE & TIME ADJ	Set the built-in clock.	–	43
20 TOT	Set the timeout timer.	OFF / 30 SEC to 10 MIN (European version: 3 MIN)	152
21 VFO MODE	Select the frequency selection range in the VFO mode.	ALL / BAND	152
22 VIBRATOR	Select a vibrator mode and set up the vibrator function.	MODE: OFF / BUSY / SIGNALING SELECT: PATTERN1 / PATTERN2 / PATTERN3	113
23 DIAL KNOB CHANGE	Swap the DIAL and VOL knob functions.	–	152
APRS			
1 APRS AF DUAL	Turn on/off the muting function when both the APRS function and AF dual function are active.	ON / OFF	–
2 APRS DESTINATION	Display the model code.	APY02D (Uneditable)	–
3 APRS FILTER	Select the filter function.	Mic-E: ON / OFF POSITION: ON / OFF WEATHER: ON / OFF OBJECT: ON / OFF ITEM: ON / OFF STATUS: ON / OFF OTHER: ON / OFF ALTNET: ON / OFF	–
4 APRS MODEM	Set the APRS baud rate.	OFF / 1200bps / 9600bps	–
5 APRS MSG FLASH	Set the strobe to flash when there is an incoming message.	MSG: OFF / 2s to 60s / CONTINUOUS / EVERY 2s to EVERY 10s 4sec GRP: OFF / 2s to 60s / CONTINUOUS 4sec BLN: OFF / 2s to 60s / CONTINUOUS 4sec	–

Tables of Set Mode Operations

Set mode no. / item	Description	Selectable options (Options in bold are the default settings)	Page
6 APRS MSG GROUP	Group filtering for received messages.	G1: ALLxxxxxx G2: CQxxxxxx G3: QSTxxxxxx G4: YAESUxxxxxx G5: ----- B1: BLNxxxxxx B2: BLNx B3: BLNx	-
7 APRS MSG TXT	Input the fixed text message.	1 to 8 ch	-
8 APRS MUTE	Set the B-band AF muting function on/off when APRS is active.	ON / OFF	-
9 APRS POPUP	Set the beacon type, message type and time for pop-up display.	The setting values of Mic-E, POSITION, WEATHER, OBJECT, ITEM, STATUS, OTHER, MY PACKET, MSG, GRP and BLN are as follows. OFF / ALL2s to ALL60s / ALLCNT / BND2s to BND60s / BNDCNT ALL10s The setting values of MY MSG, DUP.BCN, DUP.MSG. ACK.REJ and OTHER MSG are as follows. OFF / BND2s to BND60s BND10s	-
10 APRS RINGER	Set the bell ring on/off when a beacon or message is received.	Mic-E: ON / OFF POSITION: ON / OFF WEATHER: ON / OFF OBJECT: ON / OFF ITEM: ON / OFF STATUS: ON / OFF OTHER: ON / OFF MY PACKET: ON / OFF MSG: ON / OFF GRP: ON / OFF BLN: ON / OFF MY MSG: ON / OFF DUP.BCN: ON / OFF DUP.MSG: ON / OFF ACK.REJ: ON / OFF OTHER MSG: ON / OFF TX BCN: ON / OFF TX MSG: ON / OFF	-
11 APRS UNIT	Select the units for APRS display.	POSITION: MM.MM' / MM'SS" DISTANCE: km / mile SPEED: km/h / knot / mph ALTITUDE: m / ft TEMP: °C / ° F RAIN: mm / inch WIND: m/s / mph	-
12 APRS TX DELAY	Set the data sending delay time.	100ms / 150ms / 200ms / 250ms / 300ms / 400ms / 500ms / 750ms / 1000ms	-

Tables of Set Mode Operations

Set mode no. / item	Description	Selectable options (Options in bold are the default settings)	Page
13 BEACON INFO	Set the transmission beacon information.	AMBIGUITY: OFF / 1 digit / 2 digit / 3 digit / 4 digit SPD / CSE: ON / OFF ALTITUDE: ON / OFF	-
14 BEACON INTERVAL	Set a beacon automatic sending interval.	30sec / 1min / 2min / 3min / 5min / 10min / 15min / 20min / 30min / 60min	-
15 BEACON STATS TXT	Input setting for status text.	S.TXT: ON / OFF TX RATE: 1/1 to 1/8 TEXT: TEXT1 to TEXT5	-
16 BEACON TX	Select automatic or manual sending of beacon.	AUTO / MANUAL	-
17 COM PORT SETTING	Set the COM port.	STATUS: ON / OFF SPEED: 4800 / 9600 / 19200 / 38400 INPUT: OFF / GPS OUTPUT: OFF / GPS / WAY.P / DSP H / DSP A / DSP D WAYPOINT: NMEA9 / NMEA6 / NMEA7 / NMEA8 Mic-E: ON / OFF POSIT: ON / OFF WEATHER: ON / OFF OBJECT: ON / OFF ITEM: ON / OFF	-
18 DIGI PATH	Set the digital repeater route.	P1 OFF P2(1) 1 WIDE1-1 P3(2) 1 WIDE2-1 / 2 WIDE2-1 P4(2) 1 / 2 P5(2) 1 / 2 P6(2) 1 / 2 P7(2) 1 / 2 P8(8) 1 to 8	-
19 GPS SETUP	Select a datum used for the GPS function.	DATLM: WGS-84 / Tokyo (Mean) PINNING: ON / OFF DGPS: ON / OFF	-
20 GPS POWER	Turn the GPS function on/off.	GPS ON / GPS OFF	-
21 GPS TIME SET	Turn on/off the GPS time and date automatic acquisition function.	AUTO / MANUAL	-
22 GPS UNIT	Select the units for GPS display.	POSITION: .MMM' / 'SS" SPEED: km/h / knot / mph ALTITUDE: m / ft	-
23 CALLSIGN (APRS)	Specify the call sign of your station.	- - - - - - - -	-
24 MY POSITION	Set your location	GPS / Manual / P1 to P10	-
25 MY SYMBOL	Set your station symbol.	48 icons including 1([Human person]]) / 2(/b Bicycle) / 3(/> Car) / 4(YY Yaesu Radios)	-
26 POSITION COMMENT	Set up the position comment function.	Off Duty / En Route / In Service / Returning / Committed / Special / Priority / Custom 0 to 6 / EMERGENCY!	-

Tables of Set Mode Operations

Set mode no. / item	Description	Selectable options (Options in bold are the default settings)	Page
27 SmartBeaconing	Set the smart beaconing function.	STATUS: OFF / TYPE1 / TYPE2 / TYPE3 * For details on the following setting items for each type, refer to the APRS Instruction Manual. LOW SPD, HIGH SPD, SLOW RATE, FAST RATE, TURN ANGL, TURN SLOP, TURN TIME	–
28 TIME ZONE	Set the time zone.	UTC -13:00 to UTC 0:00 to UTC +13:00 UTC 0:00	–
* For details of the functions, refer to the APRS Instruction Manual.			
SD CARD			
1 BACKUP	Save the data stored on the transceiver onto a microSD memory card or load the data from a microSD card.	Write to SD / Read from SD	154
2 MEMORY CH	Save or load the memory channel information onto or from a microSD memory card.	Write to SD / Read from SD	155
3 GROUP ID	Save or load the GROUP ID information onto or from a microSD memory card.	Write to SD / Read from SD	155
4 FORMAT	Initialize microSD memory cards.		31
OPTION			
1 USB CAMERA	Set the USB camera image size, resolution and Speaker.	SIZE: 160*120 / 320*240 QUALITY: LOW / NORMAL / HIGH SP SEL: CAMERA / INT SP	157
1 CALLSIGN	Set the call sign.	xxxxxxxxxx	158

Set Mode: DISPLAY Menu Operations

Press and hold the **[DISP]** key for over one second to display “SETUP MENU”, then touch **[DISPLAY]** to reveal specific items.

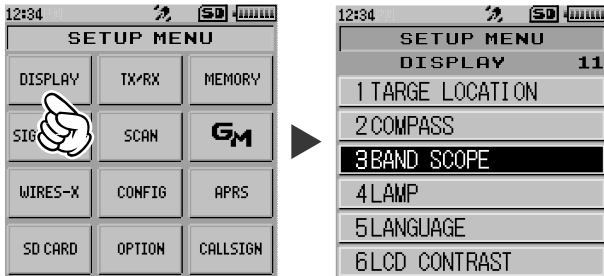

After completing the setup, press **[EXIT]** to exit from Set mode.

Setting What to Display Using the Smart Navigation Function

Set what to display on the smart navigation screen.

- 1 Touch **[1 TARGET LOCATION]**.
- 2 Rotate the DIAL to select what is displayed on the screen.

COMPASS	Displays the compass.
NUMERIC	Displays the latitude and longitude.

Remark The default setting: COMPASS

Setting the Compass Display

Set the compass display.

- 1 Touch **[2 COMPASS]**.
- 2 Rotate the DIAL to select the desired setting.

HEADING UP	The heading direction is indicated at the top of the compass.
NORTH UP	The north direction is indicated at the top of the compass.

Remark The default setting: HEADING UP

Setting the Search Channels for the BAND SCOPE Function

Set the number of channels to be displayed for the band scope when the BAND SCOPE function is used.

- 1 Touch **[3 BAND SCOPE]**.
- 2 Rotate the DIAL to select the number of channels to search for.
17ch / 35ch / 71ch

Remark The default setting: 35ch

Changing the Lighting Condition

Change the LCD and key lighting condition.

- 1 Touch [**4 LAMP**].
- 2 Rotate the DIAL to select [KEY], then press the **[DISP]** key.
- 3 Rotate the DIAL to select the lighting condition.

2 SEC (KEY) to 10 SEC (KEY)	When the DIAL is rotated or a key is pressed, the LCD and key lights remain illuminated for the set time.
CONTINUOUS	The LCD and key lights remain illuminated.
OFF	The LCD and keys do not light up.

Remark The default setting: 5 SEC (KEY)

- 4 Press the **[DISP]** key.
- 5 Rotate the DIAL to select [SAVE], then press the **[DISP]** key.
- 6 Rotate the DIAL to select the lighting status after the set illumination time elapses.

OFF	After the illumination time selected for [KEY] elapses, the lights dim to [LEVEL 1] of the LCD dimmer setting.
ON	After the illumination time selected for [KEY] elapses, lights turn off.

Remark The default setting: OFF

Caution

When [KEY] is set to CONTINUOUS, regardless of the [SAVE] setting, the illumination stays lit according to the LCD dimmer setting level.

Selecting the Display Language

Select the display language from Japanese and English.

- 1 Touch [**5 LANGUAGE**].
- 2 Rotate the DIAL to select the desired language.

JAPANESE	Japanese is selected.
ENGLISH	English is selected.

Remark The default setting: English

Adjusting the LCD Contrast Level

Adjust the LCD contrast level.

- 1 Touch [**6 LCD CONTRAST**].
- 2 Rotate the DIAL to select the desired contrast level.
Select from LEVEL 1 to LEVEL 15.

Remark The default setting: LEVEL 7

Adjusting the LCD Backlight and Key Button Light Brightness Level

Adjust the brightness level of the LCD backlight and key button* light.

- 1 Rotate the DIAL, then touch **[7 LCD DIMMER]**
- 2 Rotate the DIAL to select the desired brightness level.

Select from LEVEL 1 to LEVEL 6.

Remark The default setting: LEVEL 6

*"Key button" refers to the keys / switches such as **[BACK]** and **[DISP]** located below the LCD panel.

Changing the Opening Message Displayed Immediately after Power-on

You can select the message under the "YAESU" logo displayed when turning on the transceiver.

- 1 Rotate the DIAL, then touch **[8 OPENING MESSAGE]**.
- 2 Rotate the DIAL to select the desired message referring to the following table.

OFF	Displays the receive frequency instead of the opening message immediately after turning on the power.
DC	Displays the power-supply voltage and time when turning on the power.
MESSAGE	Displays a message comprising up to 16 characters when turning on the power. Press the [DISP] key to switch the screen to the message registration screen. See "Entering Letters" on page 19 to input the message you want to display.
CALLSIGN	Displays your call sign when turning on the power.

Displaying the Battery Voltage

Display the battery voltage. When the optional external power supply adapter with a cigarette plug (SDD-13) is connected, the power supply voltage of this adapter is displayed.

- 1 Rotate the DIAL, then touch **[9 SENSOR INFO]**.

The battery voltage is shown on the LCD.

Tips

- The indication differs depending on the type of the power supply used.
 Battery pack: "Lit"
 Battery case: "Dry"
 External power supply adapter: "Ext"
- During mono band receive, the voltage can be displayed on the LCD constantly (see page 34).

Changing the Display Pattern of the S-Meter

Select the desired display pattern of the S-Meter.

- 1 Rotate the DIAL, then touch **[10 S-METER SYMBOL]**.
- 2 Rotate the DIAL to select the desired display pattern.



Remark The default setting: 1

Displaying the Software Version

Display the software version.

- 1 Rotate the DIAL, then touch **[11 SOFTWARE VERSION]**.
The software versions of “Main”, “Sub” and “DSP” are shown.

Set Mode: TX/RX Menu Operations

Press and hold the **[DISP]** key for over one second to display “SETUP MENU”, then touch **[TX/RX]** to display the sub-menu items. Set each item under the sub-menu.

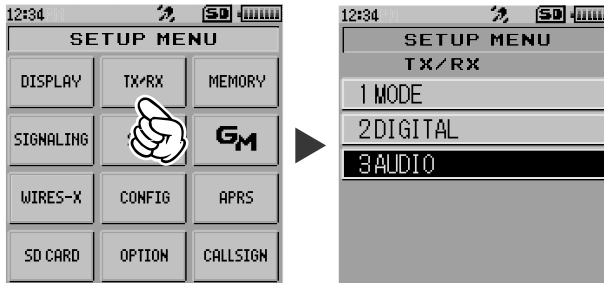

After completing the setup, press **[EXIT]** to exit from Set mode.

Reducing Receiver Sensitivity Attenuator (ATT) Function

If the signal from the remote station is too strong or, a strong signal exists nearby that interferes with reception, use the attenuator (ATT) function to reduce interference by selecting **[1 MODE]** → **[1 ANTENNA ATT]**.

For details, see “Attenuator (ATT) Function (except AM broadcasts and AM broadcasts)” on page 50.

Tip

The amount of attenuation by the attenuator (ATT) is about 10 dB.

Setting the Transmit Modulation Level

The transmit modulation level can be set to half of its usual level.

Select **[OFF]** for normal amateur operation.

- 1 Touch **[1 MODE]**.
- 2 Touch **[2 HALF DEVIATION]**.
- 3 Rotate the DIAL to select the desired setting.

OFF	Normal transmission modulation level
ON	The level is half of the normal transmit modulation level.

Remark The default setting: OFF

Switching the Receive Mode

Manually switch to a suitable mode (radio wave type) according to the frequency band by selecting [1 MODE] → [3 RX MODE].

For details, see “Changing the Mode” on page 48.

Setting the Squelch Type for the Digital Mode

Set the squelch type for the digital mode.

- 1 Touch [2 DIGITAL].
- 2 Touch [1 SQL TYPE].
- 3 Rotate the DIAL to select [SQL TYPE], then press the [DISP] key.
- 4 Rotate the DIAL to select the desired squelch type.

OFF	Audio is always output upon receiving a digital signal from a Yaesu transceiver.
CODE	Audio is output only when receiving a signal with a corresponding SQL CODE.
BREAK	Audio is output regardless of any squelch code when the remote station transmits with BREAK set.

Remark The default setting: OFF

- 5 Press the [BACK] key.
- 6 Rotate the DIAL to select [SQL CODE], then press the [DISP] key.
- 7 Rotate the DIAL to select the desired code.
Set SQL CODE any one of 126 types (001 to 126).

Setting the Pop-up Time of the Remote Station Information

Set the time duration to display the remote station information such as the call sign, on the LCD.

- 1 Touch [2 DIGITAL].
- 2 Touch [2 DIGI POPUP].
- 3 Rotate the DIAL to select the desired setting.

OFF	The remote station information is not displayed.
BND2s to 60s	Set the time duration to display the remote station information (2 to 60 seconds). BND2s / BND4s / BND6s / BND8s / BND10s / BND20s / BND30s / BND60s
BNDCNT	The remote station information is continuously displayed.

Remark The default setting: BAND 10 seconds

Displaying Your Location in Digital Mode

Set whether or not to display your location in digital mode.

- 1 Touch [2 DIGITAL].
- 2 Touch [3 LOCATION SERVICE].
- 3 Rotate the DIAL to select the desired setting.

ON	Displays your location.
OFF	Does not display your location.

Remark The default setting: ON

For details on the function, refer to the GM Function Instruction Manual.

Setting the Standby Beep

Set whether or not to emit the standby beep sound when the remote station completes transmission.

- 1 Touch [2 DIGITAL].
- 2 Touch [4 STANDBY BEEP].
- 3 Rotate the DIAL to select the desired setting.

ON	Emits the standby beep sound.
OFF	Does not emit the standby beep sound.

Remark The default setting: ON

Adjusting the Microphone Sensitivity — Microphone Gain

You can adjust the input level of the built-in microphone or an optional external microphone.

- 1 Touch [3 AUDIO].
- 2 Touch [1 MIC GAIN].
- 3 Rotate the DIAL to select the desired microphone sensitivity level.

Select a microphone gain level from LEVEL 1 to LEVEL 9.

Remark The default setting: LEVEL 5

Tips

- Increasing the microphone gain excessively can distort the sound or pick up the surrounding noise, impairing intelligibility.
- Be sure to check the microphone gain whenever the microphone is changed.

Muting Audio

In the dual receive mode, the audio being received on the non-operating band can be muted by selecting **[3 AUDIO]** → **[2 MUTE]**.

For details, see “Muting Audio” on page 44.

Simultaneous Radio Broadcast Reception

Set the time to resume radio broadcast reception after transmit/receive when using simultaneously receive mode, by selecting **[3 AUDIO]** → **[3 RX AF DUAL]**.

For details, see “Setting the Resumption Time of Radio Reception” on page 101.

Set Mode: MEMORY Menu Operations

Press and hold the **[DISP]** key for over one second to display “SETUP MENU”, then touch **[MEMORY]** to set the individual items.

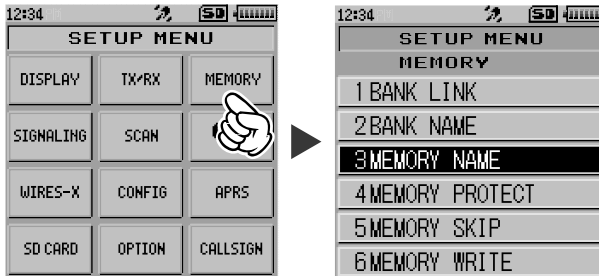

After completing the setup, press **[EXIT]** to exit from Set mode.

Setting Memory Bank Link

You can link multiple registered memory banks so that you can recall frequently used memory banks immediately.

- 1 Touch **[1 BANK LINK]**.
- 2 Rotate the DIAL to select the memory bank you want to link, then press the **[DISP]** key. The checkbox is checked.
- 3 Repeat step 2 to link the memory banks one by one from BANK 1 to BANK 24.

Assigning Name to Memory Bank

By selecting **[2 BANK NAME]**, you can assign a name to each memory bank using up to 16 characters.

For details, see “Assigning Name to Memory Bank” on page 64.

Assigning Name to Memory Channel

By selecting **[3 MEMORY NAME]**, you can assign a name such as a call sign and broadcast station name to each memory channel and home channel.

For details, see “Using Memory Tag” on page 59.

Prohibiting Registration to a Memory Channel Memory Channel Protect Function

A memory channel may be protected so that a new frequency or memory channel tag name cannot be registered to it.

- 1 Touch **[4 MEMORY PROTECT]**.
- 2 Rotate the DIAL to select the desired setting.

OFF	Allows registering to registering to memory channels.
ON	Prohibits registering to memory channels.

Remark The default setting: OFF

Setting Memory Skip Function

By selecting **[5 MEMORY SKIP]**, you can set the scan method for scanning memory channels.

For details, see “Specifying Skip/Selected Memory Channels” on page 77.

Setting the Memory Channels Used for Registration

Set whether to register to the lowest unused memory channel number following the channel number you most recently used, or to the lowest unused memory channel number.

- 1 Touch **[6 MEMORY WRITE]**.
- 2 Rotate the DIAL to select the desired setting.

NEXT	Registers to the smallest unused memory channel number which comes after the channel number you used most recently.
LOWER	Registers to the unused memory channel having the lowest memory number.

Remark The default setting: NEXT

Set Mode: SIGNALING Menu Operations

Press and hold the **[DISP]** key for over one second to display “SETUP MENU”, then touch **[SIGNALING]** to set the individual items.

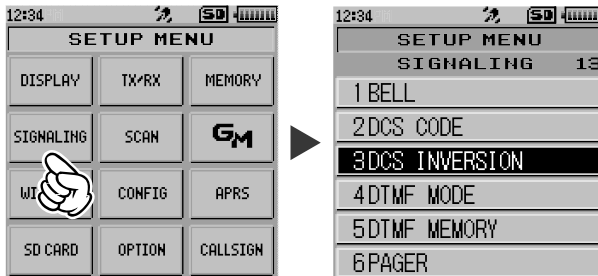

After completing the setup, press **[EXIT]** to exit from Set mode.

Notification of a Call from a Remote Station by the Bell

Set whether or not to alert you of a call from a remote station using the bell by selecting **[1 BELL]**.

For details, see “Notification of a Call from a Remote Station by the Bell Function” on page 114.

Selecting a DCS Code

Select the DCS code out of the 104 codes from 023 to 754 by selecting **[2 DCS CODE]**. For more details, see “Setting the DCS Code” on page 112.

Transmitting and Receiving a DCS Code with an Inverted Phase DCS INVERSION Function

The transmit and receive DCS code phase may be inverted when using the digital code squelch function.

- 1 Touch **[3 DCS INVERSION]**.
- 2 Rotate the DIAL to select the phase combination for transmit/receive.

RX	Homeomorphic / Both Phase / Inverted Phase
TX	Homeomorphic / Inverted Phase

Remark The default setting: Receive [Homeomorphic], Transmit [Homeomorphic]

Setting the Transmission Method of the DTMF Code

Set the transmission method of the registered DTMF code by selecting **[4 DTMF MODE]**. For details, see “Transmitting the Registered DTMF Code” on page 104.

Setting the DTMF Code

By selecting **[5 DTMF SELECT]**, the maximum of 16 digit DTMF code can be registered for a telephone number to make a call through the public telephone line from a phone patch.

For details, see “Using the DTMF Function” on page 103.

Calling Only a Specific Station (New Pager Function)

When using transceivers with a group of friends, specifying individual personal codes permits directing a call to a specific station by selecting **[6 PAGER]**.

For details, see “Calling Only a Specific Station New Pager Function” on page 116.

Enabling No-communication Squelch Function PR FREQUENCY Function

Set a no-communication squelch frequency in steps of 100 Hz within the range from 300 Hz to 3000 Hz.

1 Touch **[7 PR FREQUENCY]**.

2 Rotate the DIAL to tune in to a no-communication squelch frequency.

Select a no-communication squelch frequency in steps of 100 Hz within the range from 300 Hz to 3000 Hz.

Remark The default setting: 1600 Hz

Adjusting the Squelch Level SQL LEVEL Function

Set the squelch level to mute the raspy noise heard when there is no signal.

1 Touch **[8 SQL LEVEL]**.

2 Rotate the DIAL to adjust the squelch level from LEVEL 0 to LEVEL 15.

Remark The default setting: LEVEL 1









Setting the Squelch to Activate at a Specified Signal Strength S-Meter Squelch Function

You can set A-Band and B-Band individually to emit audio only when receiving a signal stronger than the S-meter Squelch level setting.

To adjust the S-Meter squelch, first set the operating band by pressing the **[A/B]** key.

- 1 Touch **[9 SQL S-METER]**.
- 2 Rotate the DIAL to select the setting value referring to the table below.

Remark The default setting: OFF

Display	S-Meter Display	Operating Status
OFF	No display	S-Meter squelch function is OFF. (By default, S-Meter squelch function is set to OFF.)
LEVEL 1		Outputs the audio of a signal as strong or stronger than the S-Meter level 1.
LEVEL 2		Outputs the audio of a signal as strong or stronger than the S-Meter level 2.
LEVEL 3		Outputs the audio of a signal as strong or stronger than the S-Meter level 3.
LEVEL 4		Outputs the audio of a signal as strong or stronger than the S-Meter level 4.
LEVEL 5		Outputs the audio of a signal as strong or stronger than the S-Meter level 5.
LEVEL 6		Outputs the audio of a signal as strong or stronger than the S-Meter level 6.
LEVEL 7		Outputs the audio of a signal as strong or stronger than the S-Meter level 7.
LEVEL 8		Outputs the audio of a signal as strong or stronger than the S-Meter level 8.
LEVEL 9		Outputs the audio of a signal as strong or stronger than the S-Meter level 9.

Setting the Squelch Type for Transmit and Receive SQL EXPANSION Function

You can add squelch types to **[11 SQL TYPE]** for transmit and receive, respectively.

- 1 Rotate the DIAL, then touch **[10 SQL EXPANSION]**.
- 2 Rotate the DIAL to select the desired setting.

ON	Add squelch types for transmit and receive, respectively.
OFF	Does not add squelch types for transmit and receive, respectively.

Remark The default setting: OFF

Setting the Type of Squelch

Select **[11 SQL TYPE]** to open the squelch only when a signal containing the specified tone or code is received.

For details, see “Using the Tone Squelch Function” on page 109.

Selecting a CTCSS Tone Frequency

Select **[12 TONE SQL FREQ]** to select the tone frequency from 50 types between 67.0 MHz and 254.1 MHz.

For details, see “Setting the Tone Frequency” on page 110.

Setting the Sound and Speed During Tone Search Tone Search Function

The audio may be muted during tone search. The operation speed of the tone search can also be changed.

- 1 Rotate the DIAL, then touch **[13 TONE-SRCH]**.
- 2 Rotate the DIAL to select **[MUTE]**, then press the **[DISP]** key.
- 3 Rotate the DIAL to select the desired setting.

ON	Mutes the audio during the tone search operation.
OFF	Does not mute the audio during the tone search operation.

Remark The default setting: ON

- 4 Rotate the DIAL to select **[SPEED]**, then press the **[DISP]** key.
- 5 Rotate the DIAL to select the desired setting.

FAST	Speed up the tone search operation.
SLOW	Slow down the tone search operation.

Remark The default setting: FAST

ON/OFF for the Weather Alert Feature

Setting the weather Alert Feature, used for notifying storms and hurricanes, ON or OFF.

- 1 Rotate the DIAL, then touch **[14 WX ALERT]**.
- 2 Rotate the DIAL to select the desired setting.

ON	Enables the Weather Alert Feature.
OFF	Disables the Weather Alert Feature.

Remark The default setting: OFF

Set Mode: SCAN Menu Operations

Press and hold the **[DISP]** key for over one second to display “SETUP MENU”, then touch **[SCAN]** to set the individual items.

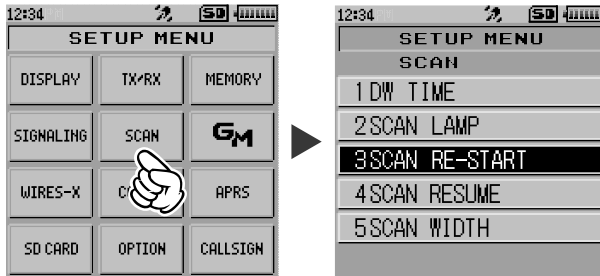

After completing the setup, press **[EXIT]** to exit from Set mode.

Setting the Surveillance Interval Time for Priority Channels DW INTERVAL TIME Function

When the dual receive function is active, the interval time at which the priority channel is monitored can be set.

- 1 Rotate the DIAL, then touch **[1 DW TIME]**.
- 2 Rotate the DIAL to select the monitoring interval from 0.1 SEC to 10 SEC.

Remark The default setting: 5.0 seconds

Setting the Illumination On/Off When Scanning Stops LAMP Function

Set whether or not the LCD backlight is turned on when a signal is received during scanning.

- 1 Rotate the DIAL, then touch **[2 SCAN LAMP]**.
- 2 Rotate the DIAL to select the desired setting.

ON	The LCD backlight will illuminate when a signal is received.
OFF	The LCD backlight will not illuminate when a signal is received.

Remark The default setting: ON

Setting the Time to Resume Scanning SCAN RE-START Function

Set the time interval to resuming scanning after a received signal ends during scanning.

- 1 Rotate the DIAL, then touch **[3 SCAN RE-START]**.
- 2 Rotate the DIAL to select the time to resume scanning from 0.1 SEC to 10 SEC.

Remark The default setting: 2.0 seconds

Selecting a Receive Operation When Scanning Stops

Touch **[4 SCAN RESUME]** to set the receive operation for when scanning stops. For details, see “Setting the Receive Operation When Scanning Stops” on page 74.

Setting the Scanning Range

You can set the frequency range for scanning in VFO mode and Memory mode.

- 1 Touch **[5 SCAN WIDTH]**.
- 2 Rotate the DIAL to select **[VFO]**, then press the **[DISP]** key.
- 3 Rotate the DIAL to select the desired setting referring to the table below.

ALL	Scans all bands from the current frequency within the 1.8 MHz to 999 MHz range.
BAND	Starting with the current frequency, scans within the current band.

- 4 Press the **[BACK]** key.
- 5 Rotate the DIAL to select **[MEMORY]**, then press the **[DISP]** key.
- 6 Rotate the DIAL to select the desired setting referring to the table below.

ALL CH	Scans all memory channels (1 to 900) starting with the currently specified memory channel. When “Selected memory channel” is selected, all specified memory channels are scanned (see page 76).
BAND	Scans only the memory channels to which the frequencies are registered, within the same frequency band* ¹ as the currently specified memory channel. When the memory channels are registered as the specified memory channels, scans only the specified memory channels to which the frequencies are registered, within the same frequency band.* ¹

*1: For the relationship between frequency bands and receive frequencies, see the table at the bottom of page 36.

Set Mode: GM Menu Operations

Press and hold the **[DISP]** key for over one second to display “SETUP MENU”, then touch **[GM]** to set the individual items.

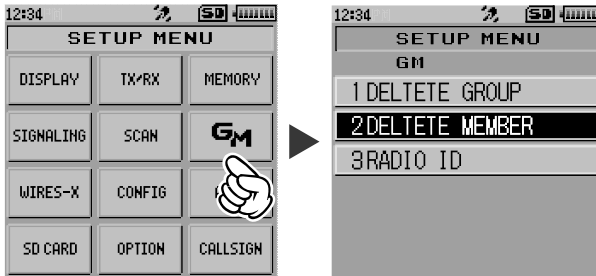

After completing the setup, press **[EXIT]** to exit from Set mode.

For details on how to set each item, refer to “FT2DR/DE GM Function Instruction Manual” which is available on Yaesu website.

Set Mode: WIRES-X Menu Operations

Press and hold the **[DISP]** key for over one second to display “SETUP MENU”, then touch **[WIRES]** to set the individual items.

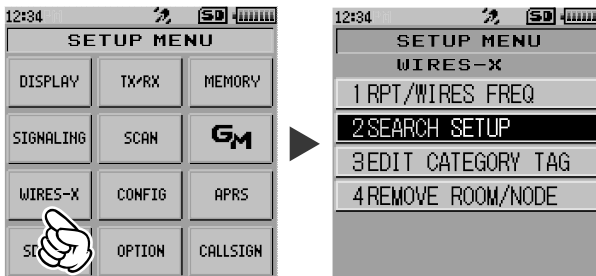

After completing the setup, press **[EXIT]** to exit from Set mode.

For details on how to set each item, refer to “FT2DR/DE WIRES-X Instruction Manual” which is available on Yaesu website.

Set Mode: CONFIG Menu Operations

Press and hold the **[DISP]** key for over one second to display “SETUP MENU”, then touch **[CONFIG]** to set the individual items.

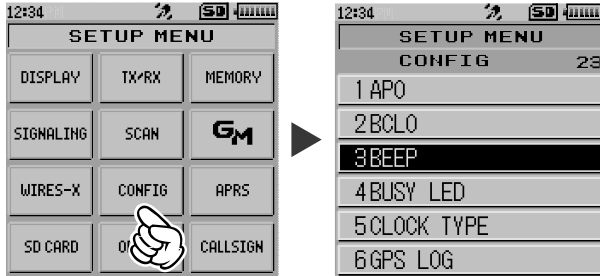

After completing the setup, press **[EXIT]** to exit from Set mode.

Turn Power Off Automatically — Auto Power-Off Function

Set whether or not to turn off the transceiver automatically if there is no operation for a certain period of time.

- 1 Touch **[1 APO]**.
- 2 Rotate the DIAL to select the desired setting.

OFF	Does not turn off the power automatically.
30 minutes to 12 hours	Turns off the power when no operation is performed for a specified period of time.

Remark The default setting: OFF

Tips

- When the auto power-off function is active, **[APO]** appears on the LCD.
- Once the time for automatic power-off is set, the new setting is retained. Unless “OFF” is selected in step 2, the next time the transceiver is turned on, if you perform no operation for the set period of time, the transceiver will automatically turn off.)

Preventing Accidental Transmission — Busy Channel Lockout (BCLO) Function

Preventing transmissions when the receive channel is busy.

- 1 Touch **[2 BCLO]**.
- 2 Rotate the DIAL to select the desired setting.

OFF	Permits starting a transmission while receiving a signal.
ON	Disables transmissions while receiving a signal.

Remark The default setting: OFF

Setting the Key Operation Confirmation Sound

Set whether or not a beep sound is emitted to confirm when keys are operated, when scanning reaches the end of a frequency band, or when a band edge/CH1 is encountered.

- 1 Touch **[3 BEEP]**.
- 2 Rotate the DIAL to select **[SELECT]**, then press the **[DISP]** key.
- 3 Rotate the DIAL to select the desired setting referring to the table below.

KEY & SCAN	Emits the beep sound when a key is operated or scanning stops.
KEY	Emits the beep sound when a key is pressed.
OFF	Mutes the beep sound.

Remark The default setting: KEY & SCAN

- 4 Press the **[BACK]**.
- 5 Rotate the DIAL to select **[EDGE]**, then press the **[DISP]** key.
- 6 Rotate the DIAL to select the desired setting referring to the table below.

OFF	No confirmation sound is emitted when a band edge/CH1 is encountered.
ON	Emits the confirmation sound when a band edge/CH1 is encountered.

Remark The default setting: OFF

Turning off the BUSY Indicator

When listening to the radio continuously or to extend the remaining battery operating time, turn off the BUSY indicator to save battery power consumption.

- 1 Touch **[4 BUSY LED]**.
- 2 Rotate the DIAL to select "A BAND", "B BAND" or "RADIO", then press the **[DISP]** key.
- 3 Rotate the DIAL to select the desired setting.

ON	Turns on the BUSY indicator.
OFF	Turns off the BUSY indicator.

Remark The default setting: ON

- 4 Press the **[BACK]** key.
- 5 To change the setting for other bands, repeat steps 2 to 4.

Setting the Clock Shift for the Micro Computer Clock Type Function

Set the micro computer Clock Shift function may be activated to eliminate an internally generated spurious high frequency signal. Select [A] for normal use.

- 1 Touch [5 CLOCK TYPE].
- 2 Rotate the DIAL to select the desired setting.

A	Automatically switches the Clock Shift function between on/off.
B	Activates the Clock Shift function constantly.

Remark The default setting: A

Setting a Time Interval for Saving GPS Position Information

Set the interval at which the current position GPS information is saved to the microSD memory card.

- 1 Touch [6 GPS LOG].
- 2 Rotate the DIAL to select the time interval:
OFF / 1 SEC / 2 SEC / 5 SEC / 10 SEC / 30 SEC / 60 SEC

If OFF is selected, no GPS Information is saved onto the microSD memory card

Remark The default setting: OFF

Tips

- Data saved onto the microSD memory card is saved in GPSymmddhmmss.LOG format.
- Saved data may be viewed by using OEM PC applications*.
- * Yaesu does not provide technical support for PC applications.

Permitting/Prohibiting Transfer of Home Channel Frequency to VFO

Set whether or not to permit tuning off of the home channel and transfer to the VFO.

- 1 Touch [7 HOME VFO].
- 2 Rotate the DIAL to select the desired setting.

ENABLE	Turning the DIAL in home channel transfers from the home channel frequency to the VFO.
DISABLE	Turning the Dial on the home channel does not switch to the VFO.

Remark The default setting: ENABLE

Using the LED Light

Set Mode: CONFIG Menu Operations





Pressing the **[DISP]** key turns the LED light on/off.

- 1 Touch **[8 LED LIGHT]**.
The LED light turns on.
- 2 Press the **[BACK]** key.
The LED light turns off.

Setting the LOCK Function

Select keys/DIAL to which you want to apply the lock function.

- 1 Touch **[9 LOCK]**.
- 2 Rotate the DIAL to select the desired setting.

KEY & DIAL	Locks the DIAL and keys on the front side of the transceiver.
PTT	Locks  .
KEY & PTT	Locks  and the keys on the front side of the transceiver.
DIAL & PTT	Locks the DIAL and  .
ALL	Locks the DIAL,  , and the keys on the front side of the transceiver.
KEY	Locks the keys on the front side of the transceiver.
DIAL	Locks the DIAL.

Remark The default setting: KEY & DIAL

Setting the Operation of the Key

Set how the transceiver functions when the  key is pressed.

- 1 Touch **[10 MONI/T-CALL]**.
- 2 Rotate the DIAL to select the desired setting.

MONI	Monitors frequencies.
T-CALL	Functions as the tone call.

Remark The default setting: MONI

Turning on/off the Transceiver at the Specified Time Timer Function

You can turn the transceiver to on or off at the specified time. Before using this function, adjust the clock referring to “Setting Clock Time” on page 43.

- 1 Rotate the DIAL, then touch **[11 TIMER]**.
- 2 Rotate the DIAL to select the desired option.

POWER ON	Turns on the transceiver at the specified time.
POWER OFF	Turns off the transceiver at the specified time.

- 3 Press the **[DISP]** key.
- 4 Rotate the DIAL to set the hour, then press the **[DISP]** key.
- 5 Rotate the DIAL to set the minute, then press the **[DISP]** key.
- 6 Touch **[TIMER ON]** or **[TIMER OFF]** to set the timer function to on or off.
Touch **[TIMER OFF]** to deactivate the timer function.

Remark The default setting: (TIMER OFF)

Password Function

You can enter a 4-digit password to prevent a third party from using your transceiver without permission. Once a password is set, the transceiver cannot be used unless the valid password is entered.

- 1 Rotate the DIAL, then touch **[12 PASSWORD]**.
- 2 Rotate the DIAL to select **[ON]**.

ON	Set the password.
OFF	Does not set the password.

Remark The default setting: OFF

- 3 Press the **[DISP]** key.
- 4 Use the numeric keypad to input your desired 4 letters using 0 to 9, A to D, * or #.
- 5 Press the **[DISP]** key.
The registered 4 letters appear.

Tips

- To deactivate the password function, select **[OFF]** in step 2, then press **[*]**.
- When the on-timer function is activated, the password function is disabled.

• Inputting the Password to Use the Transceiver

- 1 Press **[*]** for over one second.
The password input screen appears.
- 2 Use the numeric keypad to input the password.
Input the password you registered.

Set Mode: CONFIG Menu Operations

When the valid password is entered, the frequency display screen appears.

Remark If an invalid password is entered, the transceiver is turned off automatically.

Caution

If you have forgotten the registered password, carrying out all resetting allows you to turn on the transceiver without entering the password.

It should be noted that performing all resetting resets (initializes) all information such as the information registered to memory channels and various setting values.

It is recommended that the password be written down on paper.

Setting the PTT Delay Time PTT DELAY Function

Set a timed delay before actual transmission begins after  is pressed.

- 1 Rotate the DIAL, then touch **[13 PTT DELAY]**.
- 2 Rotate the DIAL to select the desired setting.

OFF/20ms/50ms/100ms/200ms

Selecting OFF disables the PTT delay time function.

Remark The default setting: OFF

Setting the ARS Function RPT ARS Function

Enable or disable the automatic Repeater Shift operation ARS (Repeater operation is initiated by tuning to the repeater frequency).

- 1 Rotate the DIAL, then touch **[14 RPT ARS]**.
- 2 Rotate the DIAL to select the desired setting.

ON	Enables the ARS function.
OFF	Disables the ARS function.

Remark The default setting: ON

Setting the Repeater Shift Direction RPT SHIFT Function

Set the TX frequency shift direction for repeater use.

- 1 Rotate the DIAL, then touch **[15 RPT SHIFT]**.
- 2 Rotate the DIAL to select the desired setting.

SIMPLEX	No TX frequency offset.
-RPT	Shifts TX to a lower frequency.
+RPT	Shifts TX to a higher frequency.

Remark The default setting differs depending frequency

Setting the frequency offset for Repeater Shift RPT SHIFT FREQ Function

Set the repeater shift offset frequency.

- 1 Rotate the DIAL, then touch **[16 RPT SHIFT FREQ]**.
- 2 Rotate the DIAL to select the desired shift offset.

The offset frequency can be set in steps of 0.05 MHz between 0.000 MHz and 150.000 MHz.

Remark The default setting differs depending frequency

Disabling Receiver While No Signal Is Received Receiver Battery Save Function

Sets the Receive OFF Battery save interval (sleep ratio) to reduce power consumption.

- 1 Rotate the DIAL, then touch **[17 SAVE RX]**.
- 2 Rotate the DIAL to select the desired setting (the time interval for disabling the receiver operation).

0.2 sec (1:1) to 1.0 sec (1:5)	In steps of 0.1 second
to 1.0 sec (1:5) to 10 sec (1:50)	In steps of 0.5 second
to 1.0 sec (1:50) to 60 sec (1:300 sec)	In steps of 5 second
OFF	

Selecting OFF disables this function.

Remark The default setting: 0.2 sec (1:1)

Changing the Frequency Step Manually

Rotate the DIAL to select **[18 STEP]** to set each frequency step, when the Dial Knob is turned manually.

For details, see “Setting the Frequency Step” on page 47.

Setting Clock Time

Rotate the DIAL to select **[19 DATE & TIME ADJ]** to set the built-in clock time.

For details, see “Setting Clock Time” on page 43.

Limit the time of a continuous transmission (TOT Function)

Set the transceiver to automatically return to receive mode after transmitting continuously for a certain period of time. The TOT function limits inadvertent transmission of unnecessary signals, and unwanted battery power consumption (time-out timer function).

- 1 Rotate the DIAL, then touch **[20 TOT]**.
- 2 Rotate the DIAL to set the time for the transceiver to automatically return to receive mode state in steps of 30 seconds.

OFF/30 SEC to 10 MIN

Selecting OFF disables the TOT function.

Remark The default setting: OFF (European version: 3 MIN)

Tips

- When the time-out timer function is active, a beep is emitted when a continuous transmission nears the set time. About 10 seconds later, the transceiver returns to the receive mode.
- The TOT setting is retained until "OFF" is selected in step 2 above.

Setting the Frequency Selection Range for Operation in VFO Mode VFO MODE Function

Sets the frequency tuning range while operating in VFO mode.

- 1 Rotate the DIAL, then touch **[21 VFO MODE]**.
- 2 Rotate the DIAL to select the desired tuning range.

ALL	Tuning continues to the next band when reaching the end of a band.
BAND	Tuning continues to the other end of the current band when reaching the end of the band.

Remark The default setting: ALL

Notifying a Call From a Remote Station by Vibration

Rotate the DIAL to select **[22 VIBRATOR]** to set the vibrator which notifies you of a call from a remote station.

For details, see "Notification of a Call from a Remote Station by Vibration" on page 113.

Swapping the Dial Knob Functions

- 1 Rotate the DIAL, then touch **[23 DIAL KNOB CHANGE]**.
- 2 Press the **[CHANGE]** key.

The VOL and DIAL knob functions are swapped.

Remark The default setting: the upper knob is DIAL.

Set Mode: APRS Menu Operations

Press and hold the **[DISP]** key for over one second to display “SETUP MENU”, then touch **[APRS]** to set the individual items.

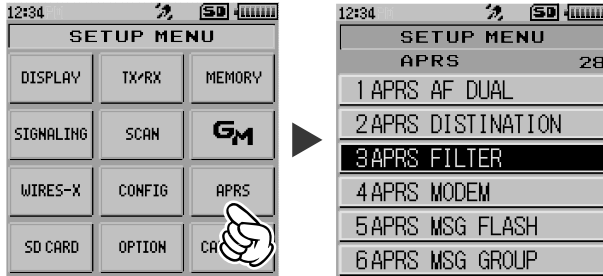

After completing the setup, press **[EXIT]** to exit from Set mode.

For details on setting each item, refer to “FT2DR/DE APRS Instruction Manual” which is available on Yaesu website.

Set Mode: SD CARD Menu Operations

Press and hold the **[DISP]** key for over one second to display “SETUP MENU”, then touch **[SD CARD]** to set the individual items.

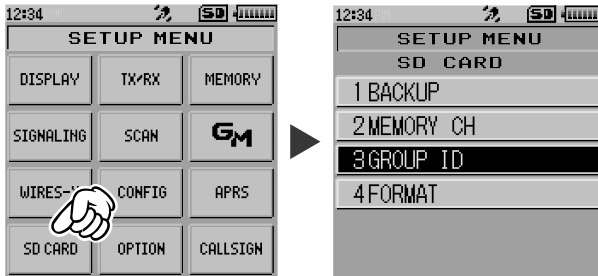

After completing the setup, press **[EXIT]** to exit from Set mode.

Saving/Loading Data to/from microSD Memory Card

Settings information can be saved to a microSD memory card, also the saved information can be loaded to the transceiver.

1 Rotate the DIAL, then touch **[1 BACKUP]**.

2 Rotate the DIAL to select the operation to be performed.

Write to SD	Saves the transceiver setting information to a microSD memory card.
Read from SD	Loads the information to the transceiver from a microSD memory card.

3 Press the **[DISP]** key.

A pop-up window appears on the LCD.

4 Touch **[OK]**.

5 Touch **[OK]** again.

When **[Write to SD]** is selected and data writing completes, a beep sounds and “COMPLETED” appears on the LCD.

When **[Read from SD]** is selected and data reading completes, a beep sounds, then the transceiver restarts with the settings read from the microSD memory card applied.

Saving/Loading Memory Channel Information to/from microSD Memory Card

Memory channel setting information can be saved onto a microSD memory card, or saved information can be loaded to the transceiver.

- 1 Rotate the DIAL, then touch **[2 MEMORY CH]**.
- 2 Rotate the DIAL to select the operation to be performed.

Write to SD	Saves the memory channel information saved on the transceiver onto a microSD memory card.
Read from SD	Loads the information to the transceiver from the microSD memory card.

- 3 Press the **[DISP]** key.
A pop-up window appears on the LCD.
- 4 Touch **[OK]**.
- 5 Touch **[OK]** again.
When **[Write to SD]** is selected and data writing completes, a beep sounds and "COMPLETED" appears on the LCD.
When **[Read from SD]** is selected and data reading completes, a beep sounds, then the transceiver restarts with the settings read from the microSD memory card applied.

Saving/Loading GROUP ID Information to/from a microSD Memory Card

The Group ID setting information can be saved onto a microSD memory card, or saved information can be loaded to the transceiver.

- 1 Rotate the DIAL, then touch **[3 GROUP ID]**, then press the **[DISP]** key.
- 2 Rotate the DIAL to select the operation you want to perform.

Write to SD	Saves the GROUP ID information saved on your transceiver to a microSD memory card.
Read from SD	Loads the information to your transceiver from a microSD memory card.

- 3 Press the **[DISP]** key.
Displays a list of the groups registered with the transceiver (or saved on the microSD memory card).
- 4 Select the group you want to copy to or from the microSD memory card using the **[DISP]** key.
 is displayed for the selected image and is displayed for unselected images.
- 5 Touch **[WRITE]** or **[READ]**.
A pop-up window appears on the LCD.
- 6 Touch **[OK]**.

7 Touch **[OK]** again.

When **[Write to SD]** is selected and data writing completes, a beep sounds and “COMPLETED” appears on the LCD.

When **[Read from SD]** is selected and data reading completes, a beep sounds, then the transceiver restarts with the settings read from the microSD memory card applied.

Formatting a microSD Memory Card

Format a new microSD memory card.

For details, see “Formatting a microSD Memory Card” on page 31.

Set Mode: OPTION Menu Operations

Press and hold the **[DISP]** key for over one second to display “SETUP MENU”, then touch **[OPTION]** for the USB camera setting.

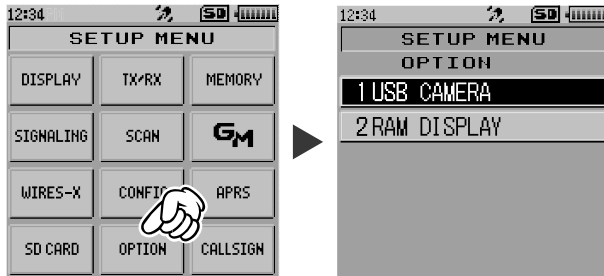

After completing the setup, press **[EXIT]** to exit from Set mode.

Setting the Optional Microphone With Camera for Use

Image size and quality can be set for the optional microphone with camera (MH-85A11U).

- 1 Touch **[1 USB CAMERA]**.
- 2 Rotate the DIAL to select **[SIZE]**, then press the **[DISP]** key.
- 3 Rotate the DIAL to select one of the following image size settings.
160*120 / 320*240
- 4 Press the **[BACK]** key.
- 5 Rotate the DIAL to select **[QUALITY]**, then press the **[DISP]** key.
- 6 Rotate the DIAL to select one of the following image quality levels.
LOW / NORMAL / HIGH

Remark The default setting: 160*120

- 7 Rotate the DIAL to select **[SP SEL]**, then press the **[DISP]** key.
- 8 Rotate the DIAL to select the speaker.

CAMERA The audio is routed to MH-85A11U speaker (internal speaker is off).

INT SP The audio is routed to the internal speaker (MH-85A11U speaker is off).

Remark The default setting: CAMERA

Cautions

- If image size is set to large or image quality is set to high, the data transmission time becomes longer.
- The transmission time varies depending on the image size.

Set Mode: CALLSIGN Menu Operations

Press and hold the **[DISP]** key for over one second to display “SETUP MENU”, then touch **[CALLSIGN]** for the call sign setting.

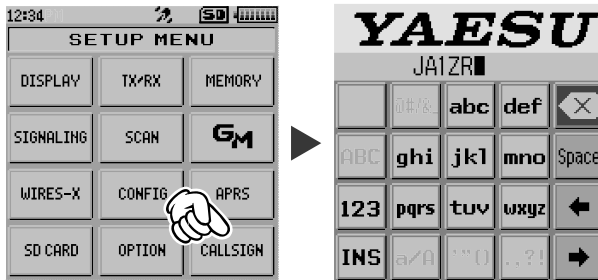

- 1 See “Entering Letters” on page 19 to input the call sign, then press **[ENTER]**. After registering the call sign, the transceiver exit from Set mode.

Using the Transceiver for Packet Communication

You can perform packet communication with your transceiver by connecting a TNC (Terminal Node Controller) using an optional Microphone Adapter (CT-44).

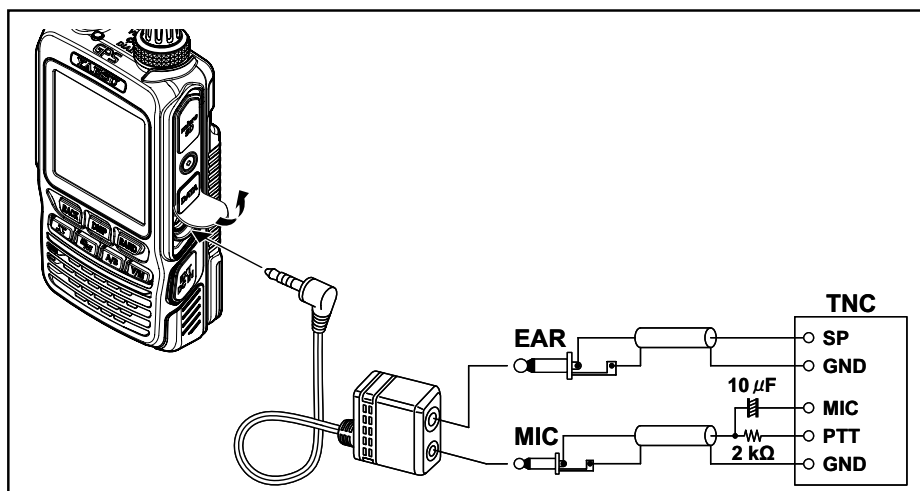

After connecting the TNC to the transceiver, set the output signal level to the TNC by adjusting the sound volume level of your transceiver.

Also, adjust the signal level input to your transceiver using the output level adjustment volume on the TNC (Input level cannot be adjusted on your transceiver).

Caution

When sending a vast volume of data, the transmission takes a longer time and the transceiver may be overheated. If the transmission is continued for a long time, the overheat prevention circuit will operate and the transmission power decreases. If the transmission is continued further, the transmission will be automatically stopped to prevent the transceiver from overheating and consequently malfunctioning. If the overheat prevention circuit has operated and then the transceiver returns to the receive mode, turn the transceiver off, or leave it in the receive mode until the temperature falls.

Tips

- Set the receive battery Save Function to OFF during packet communication by selecting **[CONFIG]** → **[17 SAVE RX]** in the Set mode.
- Reception can be interfered with by noise generated from your PC.
- If the transceiver enters an abnormal receive state, disconnect the transceiver from the PC, and reconnect it to the PC using a photo coupler device or noise filter.
- For details on how to connect TNC to the PC, refer to the TNC instruction manual.

Clone Operation

Data and various settings saved in your transceiver can be copied to any other FT2DR/DE transceiver.

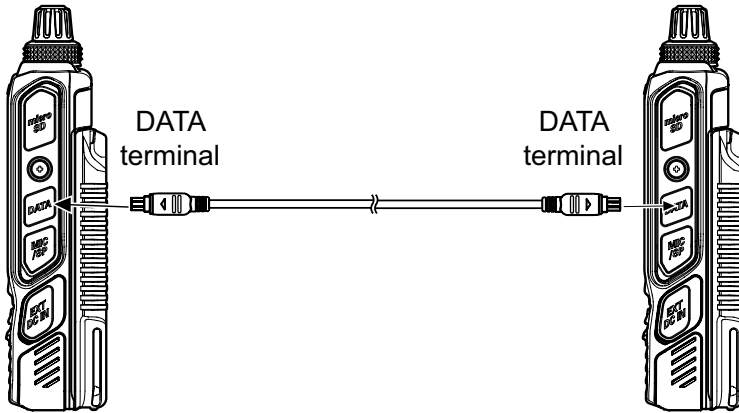

- 1 Turn off the power of both FT2DR/DE transceivers, then connect an optional clone cable (CT-168) to the DATA terminal of each transceiver.
- 2 While pressing and holding the **[DISP]** keys on both FT2DR/DE transceivers, press **[M]**.

The two transceivers are turned on and placed in the clone mode.

- 3 Touch **[RECEIVE]** on the receiving side transceiver and **[SEND]** on the transmitting side.

Data copy starts.

When data copy starts, the display on the receiving transceiver changes from "--WAIT--" to "--RX--". On the transmission side transceiver, when data transmission begins, the transmission data amount indicator appears on the LCD. On the receiving side transceiver, when data reception starts, the indicator appears on the LCD as well.

Tips When copying is completed, the receiving side transceiver returns to the normal mode. On the transmission side transceiver, the indication on the LCD returns from "--TX--" to "CLONE".

- 4 Turn off the power of both transceivers, then disconnect the clone cable.

Cautions

- When the "ERROR" appears on the LCD during data transfer, copying cannot be completed. Check the clone cable connection, and redo the operation from the beginning.
- Time data cannot be copied.

Connecting an External Device

Connecting to a PC

Exporting position location information received by the FT2DR/DE internal GPS unit

To enable data transfers, connect a Personal Computer to the DATA terminal of the transceiver with the optional PC connection cable (SCU-19), as described below.

To output location information data from the internal GPS unit, change Set mode [APRS] → [17 COM PORT SETTING] from [OUTPUT] to [GPS]. This enables the transceiver to transmit your location information to the PC at about one second intervals. Using this location information, you can display your current location information on the map software, etc.

- Tips**
- For details on setting “17 COM PORT SETTING”, see Set mode in the APRS Instruction Manual.
 - To display the location information, software compatible with NMEA-0183 specifications for GGA and RMC sentence is required.
 - To use the SCU-19, a dedicated driver must be installed on the PC. To download the dedicated driver and installation manual, please refer to the YAESU website homepage (<http://www.yaesu.com>).

Updating the FT2DR/DE firmware

To update the transceiver firmware, connect your PC to the DATA terminal of the transceiver with the supplied USB cable, as described below:

When a new firmware update for the FT2DR/DE is available, download the data from the YAESU website to update the FT2DR/DE to the latest version.

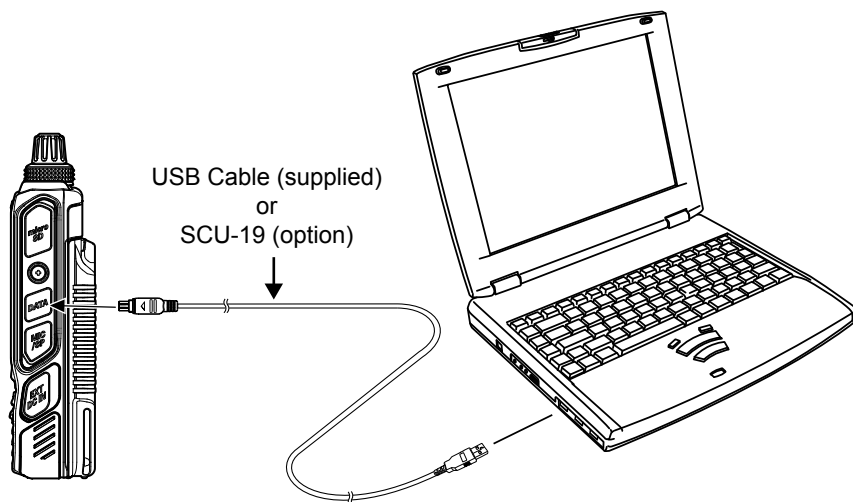

Connecting to an External Device

The location information data can be exchanged with commercially available GPS receivers or other external devices by using the optional Data Cable (CT-170).

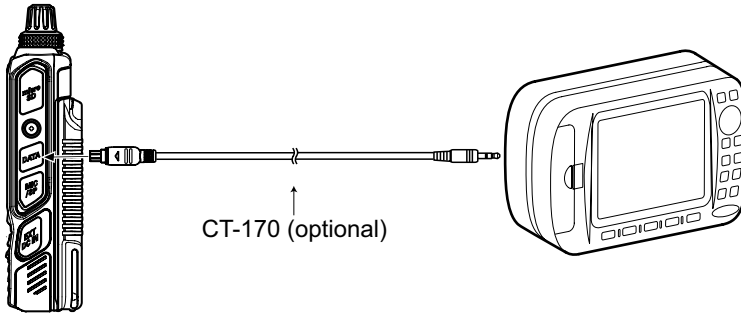

Tip

Connect the Data Cable (CT-170) and the Data Output Cable (CT-176) referring to the instruction manual for the connected device and the following cable specifications.

Connection Cables

Data Cable (CT-170)

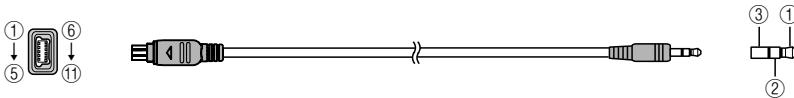

- | | |
|---|---|
| ⑦ RXD (Serial data input [FT2D←External device]) | ① RXD (Serial data input [FT2D←External device]) |
| ⑧ TXD (Serial data output [FT2D→External device]) | ② TXD (Serial data output [FT2D→External device]) |
| ⑪ GND | ③ GND |

Data Output Cable (CT-176)

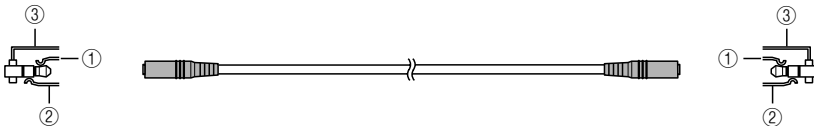

- | | |
|---|---|
| ① RXD (Serial data input [FT2D←External device]) | ① TXD (Serial data output [FT2D→External device]) |
| ② TXD (Serial data output [FT2D→External device]) | ② RXD (Serial data input [FT2D←External device]) |
| ③ GND | ③ GND |

Optional Parts

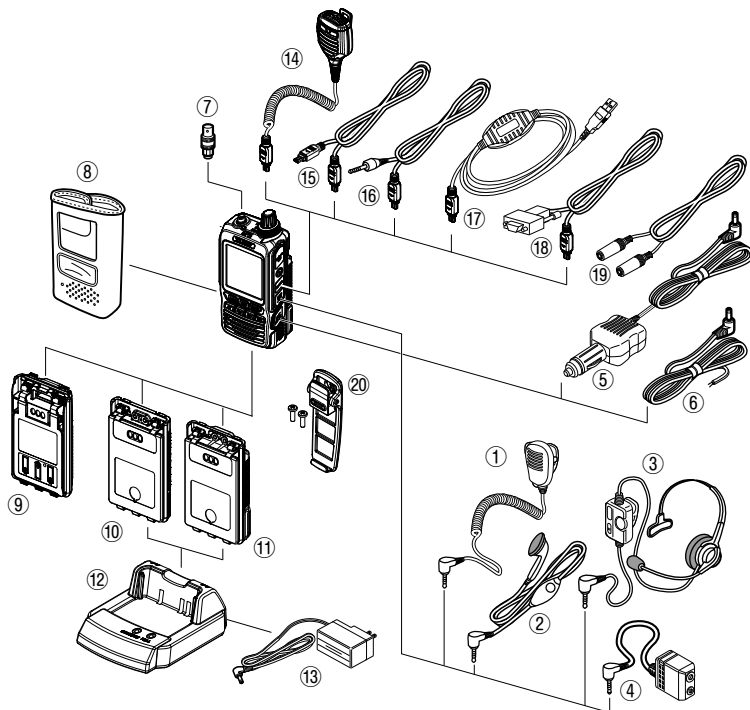

- | | |
|---|--|
| ① Speaker / Microphone (MH-34B4B) | ⑫ Rapid Charger (CD-41) |
| ② Earpiece Microphone (SSM-57A) | ⑬ Battery Charger
(Equivalent of the supplied accessory)
(PA-48B/C/F/U*) |
| ③ VOX Headset (SSM-63A) | Battery Charger (SAD-14B; for USA market) |
| ④ Microphone Adapter (CT-44) | ⑭ Speaker Microphone with Snapshot camera
(MH-85A11U) |
| ⑤ DC Cable w/ Noise Filter (SDD-13)
(USA/EXP market only) | ⑮ Clone Cable (CT-168) |
| ⑥ DC Cable (E-DC-6) (USA/EXP market only) | ⑯ Data Cable (CT-170) |
| ⑦ BNC-to-SMA Adapter (CN-3) | ⑰ PC connection cable (SCU-19) |
| ⑧ Soft Case (SHC-24) | ⑱ PC connection cable (CT-169) |
| ⑨ 3x "AA" Cell Battery Case (FBA-39) | ⑲ Data Cable (2.5Φ) (CT-176) |
| ⑩ Lithium Ion Battery Packs
(FNB-101LI, 7.4 V, 1,100 mAh) | ⑳ Belt Clip (SHB-13) |
| ⑪ Lithium Ion Battery Packs
(Equivalent of the supplied accessory)
(SBR-14LI: 7.2 V, 2,200 mAh) | |

* "B" suffix is for use with 120 VAC (Type-A plug), "C" suffix is for use with 230-240 VAC (Type-C plug), "F" suffix is for use with 220 VAC, and "U" suffix is for use with 230 VAC (Type-BF plug).

Availability of accessories may vary. Some accessories are supplied as standard per local requirements, while others may be unavailable in some regions. Consult your Yaesu Dealer for details regarding these and any newly-available options. Connection of any accessory not approved by Yaesu, should it cause damage, may void the Limited Warranty on this apparatus.



The transceiver does not turn on.

- Is the battery depleted?
Charge the battery pack after purchase, and when the transceiver has not been used for a long time.
- Is the battery pack properly attached?
Refer to "Mounting the battery pack" and securely mount the battery pack.
- Is the external power supply properly connected?
When using an external power supply, connect the external power supply adapter with a cigarette lighter plug (SDD-13) or an external power cable (E-DC-6) to DC input jack.
- Is the voltage of the battery pack or the SDD-13 correct?
Be sure that there is a charge left in the battery pack (do not completely discharge). Check that the output voltage of the SDD-13 is approximately 12V.

There is no sound.

- Is the level of squelch (or S meter squelch) set too high?
Press the Monitor Switch and verify that you can hear white noise.
Adjust the level of squelch (or S meter squelch) when receiving a weak signal.
- Is the volume low?
Rotate the VOL knob clockwise to increase the volume.
- Is the tone squelch or DCS on?
When the tone squelch or DCS is on, the sound is not output until the transceiver receives a signal containing the same tone frequency or DCS code set.

There is no transmission of radio waves.

- Are you pressing the  switch properly?
- Is the PTT lock on?
- Is the Busy TX Block (BCLO function) on?
When the Busy TX Block (BCLO function) is on, transmission cannot be done when receiving a signal even if  is pressed. Wait until signal being received stops and then press .
- Is the transmission frequency on a ham radio band?
Transmission cannot be performed on the AM Radio Broadcast Band/ Short Wave Radio Band/ FM Radio Broadcast Band/ Air Band/ Information Radio Band.
- Is the voltage of the battery pack or external power source correct?
Check the remaining charge on the battery pack.
In addition, using an inadequate power supply where voltage drops during transmission will prevent the FT2DR/DE from operating at full capability.

The keys or DIAL does not respond.

- Is the Key Lock or DIAL Lock on?

The battery pack cannot be charged or battery power depletes immediately after charging.

- Is the battery pack being charged with a charger specified by Yaesu?

Charge the battery pack using the accessory battery charger (PA-48B or SAD-14B) or the rapid charge cradle (CD-41).

When using an external power supply, use the external power supply adapter with a cigarette lighter plug (SDD-13) or an external power cable (E-DC-6).

- Is the battery pack in use exhausted?

If the "Charging Error" appears on the LCD when charging, there is a chance the battery pack is over discharged. If the error is repetitively displayed after charging the battery pack several times, the battery pack may have reached its service life or be defective. Battery packs are consumables. Please replace the battery pack with a new one immediately. Battery packs can be charged and reused up to approximately 300 times.

Depending on the combination for simultaneous reception, there may be internal beats from high frequencies caused by the internal oscillator. This is not a malfunction. (See the calculation formula below: "n" is for the arbitrary integer). Depending on the combination for simultaneous reception, there may be fluctuations in receive sensitivity.

- Receive Frequency = 12 MHz × n multiplicative
 - Receive Frequency = 16 MHz × n multiplicative
 - Receive Frequency = 15.6 MHz × n multiplicative
 - Receive Frequency = 4.9152 MHz × n multiplicative
 - Receive Frequency = 15.6 MHz × n multiplicative
 - Receive Frequency = 18.432 MHz × n multiplicative
 - Upper Side (A-Band) Frequency = (Lower Side (B-band) Frequency ± 46.35 MHz) × n multiplicative
 - Upper Side (A-Band) Frequency = (Lower Side (B-band) Frequency ± 47.25 MHz) × n multiplicative
- @ Upper Side (A-band) Mode = NFM

Index

A

Adjusting the LCD Backlight and Key Button Light	
Brightness Level	130
Adjusting the LCD Contrast Level	129
Adjusting the Microphone Sensitivity	134
AF-DUAL	100
Alphabet Input Screen	19
AM Radio	42
AMS	39
APRS	85
APRS Menu Operations	153
Assigning Name to Memory Bank	64, 136
Assigning Name to Memory Channel	136
Attaching the Supplied Accessories	20
Attenuator (ATT) Function	50, 132
Auto Power-Off Function	145

B

Backtrack Function	93
BACKTRACK Screen	18
Band Scope Screen	17
Basic Operation	32
Battery Case	25
Battery Pack	22
Bell Function	114
Busy Channel Lockout (BCLO) Function	145

C

CALLSIGN Menu Operations	158
Canceling Memory Channel Registration in Memory Bank	63
Changing the Display Pattern of the S-Meter	131
Changing the Frequency Step Manually	151
Changing the Home Channel Frequency	58
Changing the Lighting Condition	129
Changing the Number of Times the Bell Rings	115
Changing the Opening Message Displayed Immediately after Power-on	130
Clearing Memories	59
Clock Time	43, 151
Clock Type Function	147
Clone Operation	160
CONFIG Menu Operations	145
Connecting to an External Device	162
Connecting to a PC	161
Connection Cables	162
Convenient Functions	96

D

Deleting the Frequency Registered to the Skip Search	
Memory Channel	73
Digital Group Monitor Function	83
Displaying the Battery Voltage	130
Displaying the Memory Tag	61
Displaying the Software Version	131
Displaying Your Location in Digital Mode	134
DISPLAY Menu Operations	128
DTMF Function	103
DTMF Memory	103
Dual Band Screen	17
Dual Receive (DW) Function	96
DW	96

E

E-DC-6	27
External Device	161
External Power Supply	26, 27

F

FBA-39	25
FM Radio	42
Formatting a microSD Memory Card	156
Frequency Step	47
Function Menu Screen	17

G

GM	83
GM Menu Operations	144
GPS	86
GPS Log Function	89
GPS Operation	91
GPS Screen Information	91

H

Home Channel Dual Receive	98
---------------------------	----

I

If you suspect malfunction	164
----------------------------	-----

L

LED Light	148
Loading Data to/from microSD Memory Card	154
Loading GROUP ID Information to/from a microSD Memory Card	155
Loading Memory Channel Information to/from microSD Memory Card	155
LOCK Function	148
Locking Keys	49
Locking Switches	49

M

Manually Transmitting the DTMF Code	105
Memory	54
Memory Bank	62
Memory Bank Link Scanning	79
Memory Channel Dual Receive	98
Memory Channel Scanning	76
MEMORY Menu Operations	136
Memory Tag	59
Mode	48
Muting Audio	44, 135

N

New Pager Function	116, 139
Notification of a Call from a Remote Station by the Bell	138
Number Input Screen	19

O

Operating Band	34
Optional Microphone With Camera for Use	157

Optional Parts.....	163
OPTION Menu Operations	157

P

Packet Communication.....	159
Password Function.....	149
Permitting/Prohibiting Transfer of Home Channel Frequency to VFO	147
PMS.....	81
Preset Receiver.....	65
Programmable Memory Channel Scan	81
Prohibiting Registration to a Memory Channel Memory Channel Protect Function.....	137
PTT DELAY Function.....	150

R

Recalling a Memory Channel	57
Recalling Memory Bank.....	63
Recalling the Home Channels.....	57
Receiver Battery Save Function.....	151
Registering to Memory Banks	62
Registering to Memory Channel.....	55
Repeater Operation.....	52
Reset	51
Resetting the All Set Mode Settings	120
Restoring the Cleared Memories.....	59
RPT ARS Function	150
RPT SHIFT FREQ Function	151
RPT SHIFT Function	150

S

Saving Data to/from microSD Memory Card	154
Saving GROUP ID Information to/from a microSD Memory Card.....	155
Saving Memory Channel Information to/from microSD Memory Card.....	155
SCAN Menu Operations	142
Scanning Function.....	71
Scanning the Memory Bank	79
SD CARD Menu Operations.....	154
SDD-13.....	26
SD Memory Card.....	29
Searching for the CTCSS Tone	111
Searching for the DCS Code.....	112
Selecting a CTCSS Tone Frequency.....	141
Selecting a DCS Code.....	138
Selecting a Frequency Band	37
Selecting a Receive Operation When Scanning Stops	143
Selecting the Communication Mode.....	39
Selecting the Display Language.....	129
Selecting the Squelch Type.....	109
Selecting the Vibrator Operation Mode	114
Set Mode	119
Set Mode Operation	119
Setting a Time Interval for Saving GPS Position Information.....	147
Setting Memory Bank Link.....	136
Setting the Compass Display	128
Setting the DCS Code.....	112
Setting the DTMF Code.....	139
Setting the Key Operation Confirmation Sound.....	146
Setting the Memory Channels Used for Registration	137
Setting the Operation of the  Key.....	148
Setting the Pop-up Time of the Remote Station	

Information.....	133
Setting the Receive Operation When Scanning Stops	74
Setting the Scanning Range.....	143
Setting the Search Channels.....	128
Setting the Squelch Type for the Digital Mode	133
Setting the Standby Beep.....	134
Setting the Tone Frequency.....	110
Setting the Transmission Method of the DTMF Code.....	138
Setting the Transmit Modulation Level	132
Setting the Type of Squelch.....	141
Setting What to Display Using the Smart Navigation Function.....	128
SIGNALING Menu Operations	138
Simultaneous Radio Broadcast Reception	135
Skip Search Memory	72
Smart Navigation	93
S-Meter Squelch Function	140
Snapshot Function.....	107
Specifications	168
Specifying Skip/Selected Memory Channels.....	77
Spectrum Analyzer	106
Split Memory.....	56
SQL EXPANSION Function.....	140
SQL LEVEL Function.....	139
Squelch Level.....	47
Supplied Items.....	8
Swapping the Dial Knob Functions.....	152
Switching the Receive Mode	133

T

Tables of Set Mode Operations	121
Timer Function.....	149
Tone Calling (1750 Hz).....	53
Tone Search Function.....	141
Tone Squelch Function.....	109
TOT Function.....	152
Touch Screen.....	7
Transmission Power Level	46
Transmitting and Receiving a DCS Code with an Inverted Phase DCS INVERSION Function	138
Transmitting the Registered DTMF Code.....	104
Transmitting the Saved Image to Other Transceivers	108
Tuning to a Frequency.....	38
Turning off the BUSY Indicator.....	146
TX/RX Menu Operations	132

V

VFO Dual Receive.....	97
VFO MODE Function.....	152
VFO Scan	71
Vibration	113, 152
Viewing the Saved Image.....	108
Volume Level.....	34

W

Weather Alert Feature	141
WIRES-X	85
WIRES-X Menu Operations.....	144

Specifications

• General

Frequency Range (A):	RX: 520 - 1710 kHz, 1.8 - 30 MHz, 30 - 76 MHz (USA version), 30 - 88 MHz (EXP/European version), 76 - 108 MHz (USA version), 88 - 108 MHz (EXP/European version), 108 - 137 MHz, 137 - 174 MHz, 174 - 222 MHz, 222 - 420 MHz, 420 - 774 MHz (USA version), 420 - 800 MHz (EXP/European version), 803 - 999 MHz (Cellular Blocked, USA version), 800 - 999 MHz (EXP/European version)
Frequency Range (B):	RX: 108 - 137 MHz, 137 - 174 MHz, 174 - 222 MHz, 222 - 420 MHz, 420 - 470 MHz, 470 - 580 MHz
Frequency Range (A/B):	TX: 144 - 146 MHz or 144 - 148 MHz, 430 - 440 MHz or 430 - 450 MHz
Channel Steps:	5, 6.25, 8.33, 9, 10, 12.5, 15, 20, 25, 50, 100 kHz
Mode of Emission:	F1D, F2D, F3E, F7W
Frequency Stability:	±2.5 ppm (-20 °C to +60 °C [-4 °F to +140 °F])
Operating Temperature Range:	-20 °C to +60 °C (-4 °F to +140 °F)
Supply Voltage:	Nominal: 7.2 V DC, Negative Ground SBR-14LI, Nominal: 7.4 V DC, Negative Ground FNB-101LI, 4 - 14 V DC (Negative Ground (EXP DC JACK)), 11 - 16 V DC (Negative Ground (EXP DC JACK with SDD-13))
Current Consumption (Approx.):	RX: 120 mA (Mono Band Receive) 180 mA (Dual Band Receive) 80 mA (Mono Band Receive, Standby) 110 mA (Dual Band Receive, Standby) 50 mA (Mono Band Receive, Standby, Saver On "Save Ratio 1:5") 50 mA (Dual Band Receive, Standby, Saver On "Save Ratio 1:5") +20 mA (Digital) +20 mA (GPS On) 400 μ A (Auto Power Off) TX: 1.6 A (5 W TX, 144 MHz 7.2 V DC) 1.8 A (5 W TX, 430 MHz 7.2 V DC)
Case Size (W x H x D):	62 x 110 x 32.5 mm (2.4" x 4.3" x 1.3") (with SBR-14LI, w/o knob, antenna & belt clip) 62 x 110 x 27 mm (2.4" x 4.3" x 1.1") (w/o SBR-14LI, knob, antenna & belt clip)
Weight (Approx.):	310 g (10.93 oz) (with SBR-14LI & Antenna)

• Transmitter

Output Power:	5 W (@ 7.2 V DC or EXT DC)
Modulation Type:	F1D, F2D, F3E: Variable Reactance Modulation F7W: 4 FSK (C4FM)
Spurious Emission:	USA/EXP version At least 60 dB below (@TX Power HI, L3) At least 50 dB below (@TX Power L2, L1) European version At least 60 dB below (@TX Power HI, L3, L2) At least -36 dBm below (@TX Power L1)

• Receiver

Circuit Type:	Double-conversion super heterodyne (NFM / AM) Direct-conversion (AM / FM Radio)
Intermediate Frequency:	1st: A- Band 47.25 MHz (NFM / AM) 1st: B- Band 46.35 MHz (NFM / AM) 2nd: 450 kHz (NFM / AM)
Sensitivity (for 12dB SINAD):	3 μ V for 10 dB SN (0.5 - 30 MHz, AM) 0.35 μ V TYP for 12 dB SINAD (30 - 54 MHz, NFM) 1 μ V TYP for 12 dB SINAD (54 - 76 (88) MHz, NFM) 1.5 μ V TYP for 12 dB SINAD (76 (88) - 108 MHz, WFM) 1.5 μ V TYP for 10 dB SN (108 - 137 MHz, AM) 0.2 μ V for 12 dB SINAD (137 - 140 MHz, NFM) 0.16 μ V for 12 dB SINAD (140 - 150 MHz, NFM) 0.2 μ V for 12 dB SINAD (150 - 174 MHz, NFM) 1 μ V for 12 dB SINAD (174 - 222 MHz, NFM) 0.5 μ V for 12 dB SINAD (300 - 350 MHz, NFM) 0.2 μ V for 12 dB SINAD (350 - 400 MHz, NFM) 0.18 μ V for 12 dB SINAD (400 - 470 MHz, NFM) 1.5 μ V for 12 dB SINAD (470 - 540 MHz, NFM) 3 μ V TYP for 12 dB SINAD (540 - 800 MHz, NFM) 1.5 μ V TYP for 12 dB SINAD (800 - 999 MHz, NFM, Cellular Blocked) 0.19 μ V TYP for BER 1% (Digital Mode) (USA Version Cellular Blocked)
Selectivity (-6dB/-60dB):	12 kHz / 35 kHz (NFM/AM)
AF Output:	700 mW (8 Ω for 10 % THD 7.2 V) internal speaker 300 mW (8 Ω for 10 % THD 7.2 V) external speaker

Specifications are subject to change without notice, and are guaranteed within the 144/222 (USA version)/430 MHz amateur bands only.

This equipment has been tested and found to comply with the limits for a Class B digital device, pursuant to Part 15 of the FCC Rules. These limits are designed to provide reasonable protection against harmful interference in a residential installation. This equipment generates, uses and can radiate radio frequency energy and, if not installed and used in accordance with the instructions, may cause harmful interference to radio communications. However, there is no guarantee that interference will not occur in a particular installation.

If this equipment does cause harmful interference to radio or television reception, which can be determined by turning the equipment off and on, the user is encouraged to try to correct the interference by one or more of the following measures:

- Increase the separation between the equipment and receiver.
- Connect the equipment into an outlet on a circuit different from that to which the receiver is connected.
- Consult the dealer or an experienced radio/TV technician for help.

1. Changes or modifications to this device not expressly approved by YAESU MUSEN could void the user's authorization to operate this device.
2. The scanning receiver in this equipment is incapable of tuning, or readily being altered, by the User to operate within the frequency bands allocated to the Domestic public Cellular Telecommunications Service in Part 22.

This device complies with Industry Canada license-exempt RSS standard(s).

Operation is subject to the following two conditions: (1) this device may not cause interference, and (2) this device must accept any interference, including interference that may cause undesired operation of the device.

Le présent appareil est conforme aux CNR d'Industrie Canada applicables aux appareils radio exempts de licence. L'exploitation est autorisée aux deux conditions suivantes : (1) l'appareil ne doit pas produire de brouillage, et (2) l'utilisateur de l'appareil doit accepter tout brouillage radioélectrique subi, même si le brouillage est susceptible d'en compromettre le fonctionnement.

Part 15.21: Changes or modifications to this device not expressly approved by YAESU MUSEN could void the user's authorization to operate this device.

DECLARATION BY MANUFACTURER

The Scanner receiver is not a digital scanner and is incapable of being converted or modified to a digital scanner receiver by any user.

WARNING: MODIFICATION OF THIS DEVICE TO RECEIVE CELLULAR RADIOTELEPHONE SERVICE SIGNALS IS PROHIBITED UNDER FCC RULES AND FEDERAL LAW.

YAESU

Declaration of Conformity

Type of Equipment:	144/430MHz Digital/Analog Transceiver
Brand Name:	YAESU
Model Number:	FT2DR
Manufacturer:	YAESU MUSEN CO., LTD.
Address of Manufacturer:	Tennozu Parkside Building, 2-5-8 Higashi-Shinagawa, Shinagawa-ku, Tokyo 140-0002 Japan

This device complies with part 15 of the FCC Rules. Operation is subject to the following two conditions; (1) this device may not cause harmful interference, and (2) this device must accept any interference received, including interference that may cause undesired operation.

The technical documentation as required by the Conformity Assessment procedures is kept at the following address:

Company: Yaesu U.S.A.
Address: 6125 Phyllis Drive, Cypress, CA 90630, U.S.A.
Telephone: (714) 827-7600

Disposal of your Electronic and Electric Equipment

Products with the symbol (crossed-out wheeled bin) cannot be disposed as household waste. Electronic and Electric Equipment should be recycled at a facility capable of handling these items and their waste by products.

In EU countries, please contact your local equipment supplier representative or service center for information about the waste collection system in your country.



Attention in case of use

This transceiver works on frequencies which are not generally permitted.

As for the actual usage, the user has to possess an amateur radio licence.

Usage is allowed only in the frequency bands which are allocated for amateur radios.

List of national codes					
AT	BE	BG	CY	CZ	DE
DK	ES	EE	FI	FR	GB
GR	HR	HU	IE	IT	LT
LU	LV	MT	NL	PL	PT
RO	SK	SI	SE	CH	IS
LI	NO	-	-	-	-

Declaration of Conformity

Nr. YUK-DOC-0501-15

We, Yaesu UK Ltd. certify and declare under our sole responsibility that the following equip complies with the essential requirements of the Directive 1999/5/EC and 2011/65/EU.

Type of Equipment	144/430MHz Digital /Analogue Transceiver
Brand Name	YAESU
Model Number	FT2DE
Manufacturer	YAESU MUSEN CO. LTD.
Address of Manufacturer	Tennozu Parkside Building, 2-5-8 Higashi-Shinagawa, Shinagawa-ku, Tokyo, 140-0002 Japan

Applicable Standards:

This equipment is tested to and conforms to the essential requirements of directive, as incl in following standards:

Health 1999/5/EC Art. 3 (1) (a)	EN 50566 :2013
Safety 1999/5/EC Art. 3 (1) (a)	EN 60950-1:2006 + A12:2011
EMC 1999/5/EC Art. 3 (1) (b)	EN 301 489-01 V1.9.2
	EN 301 489-15 V1.2.1
Radio Spectrum 1999/5/EC Art. 3 (2)	EN 301 783-02 V1.2.1
ROHS2 2011/65/EU Art. 7 (b)	EN 50581:2012

The technical documentation as required by the Conformity Assessment procedures is ke the following address:

Company
Address
Technical Construction file

Yaesu UK Ltd
Unit 12, Sun Valley Business Park, Winnall Close

Winchester, Hampshire UK SO23 0LB
Issued by: Yaesu Musen Co. Ltd, Tokyo Jap
File No: YETA00389
Drawn up in: Winchester, Hampshire UK
Date: 08-May 2015

Signed for and on behalf of Yaesu UK Ltd



Name and position: PCJ Bigwood
Technical Sales Manager

YAESU

The radio

YAESU MUSEN CO., LTD.

Tennozu Parkside Building
2-5-8 Higashi-Shinagawa, Shinagawa-ku, Tokyo
140-0002 Japan

YAESU USA

6125 Phyllis Drive, Cypress, CA 90630, U.S.A.

YAESU UK

Unit 12, Sun Valley Business Park, Winnall Close
Winchester, Hampshire, SO23 0LB, U.K.

Copyright 2015
YAESU MUSEN CO., LTD.
All rights reserved.
No portion of this manual
may be reproduced
without the permission of
YAESU MUSEN CO., LTD.



Printed in Japan
1507D-AO

