

YAESU
The radio

HF/50 MHz TRANSCEIVER

FT-950

OPERATING MANUAL



YAESU MUSEN CO., LTD.

Tennozu Parkside Building
2-5-8 Higashi-Shinagawa, Shinagawa-ku, Tokyo 140-0002 Japan

YAESU USA

6125 Phyllis Drive, Cypress, CA 90630, U.S.A.

YAESU UK

Unit 12, Sun Valley Business Park, Winnall Close
Winchester, Hampshire, SO23 0LB, U.K.

YAESU HK

Unit 2002, 20/F, 9 Chong Yip Street,
Kwun Tong, Kowloon, Hong Kong

ABOUT THIS MANUAL . . .

The **FT-950** is a leading-edge transceiver with a number of new and exciting features, some of which may be unfamiliar to you. In order to gain the most enjoyment and operating efficiency from your **FT-950**, we recommend that you read this manual in its entirety, and keep it handy for reference as you explore the many capabilities of your new transceiver.

Before using your **FT-950**, be sure to read and follow the instructions in the “Before You Begin” section of this manual.

GENERAL DESCRIPTION

Congratulations on the purchase of your Yaesu amateur transceiver! Whether this is your first rig, or if Yaesu equipment is already the backbone of your station, rest assured your transceiver will provide many hours of operating pleasure for years to come.

The **FT-950** is an elite-class HF transceiver providing exceptional performance both on transmit and receive. The **FT-950** is designed for the most competitive operating situations, whether you primarily operate in contest, DX, or digital-mode environments.

Built on the foundation of the popular **FTdx9000** transceiver, and carrying the proud tradition of the **FT-1000** series, the **FT-950** provides up to 100 Watts of power output on SSB, CW, and FM (25 Watts AM carrier). Digital Signal Processing (DSP) is utilized throughout the design, providing leading-edge performance, both transmit and receive.

The Data Management Unit (**DMU-2000**) is available as an option for the **FT-950**. It provides extensive display capabilities via a user-supplied computer monitor. Included are Band Scope, Audio Scope, X-Y Oscilloscope, World Clock, Rotator Control, extensive Transceiver Status Displays, and Station Logging Capability.

For exceptional protection from strong signal interference, the optional RF μ Tuning Kits may be connected via the rear panel. The μ Tuning Kits provide extraordinarily sharp selectivity, and protect your receiver from close-in interference on a crowded band.

In the front end, you may select one of two RF preamplifiers, or IPO (Intercept Point Optimization) providing direct feed to the first mixer. Three levels of RF attenuation are available in 6-dB steps.

The **FT-950** receiver utilizes DSP filtering, incorporating many of the features of the **FTdx9000**, such as, Variable Bandwidth, IF Shift, and Passband Contour tuning. Also provided are Digital Noise Reduction, Digital Auto-Notch Filtering and a manually tuned IF Notch filter.

On the transmit side, the Yaesu-exclusive Three-Band Parametric Microphone Equalizer allows precise and flexible adjustment of the waveform created by your voice and microphone. The Amplitude, Center Frequency, and Bandwidth are adjusted separately for the low, mid-range, and high-frequency audio spectra. The transmitted bandwidth may also be adjusted.

Advanced features include: Direct Keyboard Frequency Entry and Band Change, Speech Processor, IF Monitor for Voice modes, CW Pitch control, CW Spot switch, Full CW QSK, adjustable IF Noise Blanker, and all-mode Squelch. Two TX/RX antenna ports are provided on the rear panel. Two key jacks are provided (one on the front and one on the rear panel). The key jacks may be configured independently for paddle input, connection to a straight key, or computer-driven keying interface. The CW Message Memory is provided.

Frequency setup is straightforward on the **FT-950**. Enter frequency directly for both VFO-A and VFO-B. Separate keys are provided for band selection. Each band key provides three separate VFO settings for three different parts of each band. You can establish three independent VFO settings of frequency, mode, and filter for each band.

In addition, 99 memories are provided to store: Frequency, Mode, IF filter selection, Clarifier offset, and Scan-skip status. What's more, five quick-recall ("QMB") memories can instantly store operational settings at the push of a button.

The built-in antenna tuner includes 100 memories that automatically store antenna matching settings for rapid automatic recall later.

Interfacing for digital modes is extremely simple with the **FT-950**, thanks to the dedicated RTTY/PKT connection jack on the rear panel. Optimization of the filter passband, DSP settings, carrier insertion point, and display offset for digital modes, is possible via the Menu programming system.

Advanced technology is only part of the **FT-950** story. Vertex Standard stands behind our products with a worldwide network of dealers and service centers. We greatly appreciate your investment in the **FT-950**, and we look forward to helping you get the most out of your new transceiver. Please feel free to contact your nearest dealer, or one of Vertex Standard's national headquarters offices, for technical advice, interfacing assistance, or accessory recommendation. Watch Vertex Standard U.S.A.'s Home Page for late-breaking information about Vertex, Standard Horizon, and Yaesu products: <http://www.vertexstandard.com>.

Please read this manual thoroughly, to gain maximum understanding of the full capability of the **FT-950**. We thank you again for your purchase!

TABLE OF CONTENTS

| | | | |
|--|----|--|----|
| General Description | 1 | Interference Rejection | 40 |
| Accessories & Options | 4 | Receiver Operation (Front End Block Diagram) ... | 40 |
| Supplied Accessories | 4 | ATT | 41 |
| Available Options | 5 | μ-Tune Filter | 42 |
| Before You Begin | 6 | IPO (Intercept Point Optimization) | 44 |
| Extending the Front Feet | 6 | R.FLT (Roofing Filters) | 45 |
| Adjusting the Main Tuning Dial Torque | 6 | IF Noise Blanker (NB) Operation | 46 |
| Resetting the Microprocessor | 7 | CONTOUR Control Operation | 47 |
| Resetting Memories (Only) | 7 | IF SHIFT Operation | 48 |
| Menu Resetting | 7 | WIDTH (IF DSP Bandwidth) Tuning | 49 |
| Full Reset | 7 | Using IF Shift and Width Together | 49 |
| Installation and Interconnections | 8 | NARROW (NAR) One-Touch IF Filter Selection ... | 50 |
| Antenna Considerations | 8 | IF Notch Filter Operation | 51 |
| About Coaxial Cable | 8 | Digital Notch Filter (DNF) Operation | 52 |
| Grounding | 9 | Digital Noise Reduction (DNR) Operation | 52 |
| Connection of Antenna and Power Cables | 10 | RF Gain (SSB/CW/AM Modes) | 53 |
| Connection of Microphone and Headphone | 11 | Tools for Comfortable and Effective Reception | 54 |
| Key, Keyer, and Computer-Driven Keying | 12 | Audio Pitch Control | 54 |
| Interconnections | 12 | Mute Feature | 54 |
| VL-1000 Linear Amplifier Interconnections | 13 | AGC (Automatic Gain Control) | 55 |
| Interfacing to Other Linear Amplifiers | 14 | SSB/AM Mode Transmission | 56 |
| Plug/Connector Pinout Diagrams | 15 | Using the Automatic Antenna Tuner | 58 |
| Front Panel Controls & Switches | 16 | ATU Operation | 58 |
| Display Indications | 24 | About ATU Operation | 59 |
| Rear Panel | 27 | Enhancing Transmit Signal Quality | 60 |
| Basic Operation: Receiving on Amateur Bands | 29 | Parametric Microphone Equalizer | 60 |
| Operation on 60-Meter (5 MHz) Band | 29 | Using the Speech Processor | 62 |
| (U.S and U.K. version only) | 32 | Adjusting the SSB Transmitted Bandwidth | 63 |
| CLAR (Clarifier) Operation | 33 | Transmitter Convenience Features | 64 |
| LOCK | 34 | Voice Memory | 64 |
| DIMMER | 34 | Voice Memory Operation from | 64 |
| Convenience Features | 35 | the optional FH-2 Remote Control Keypad | 65 |
| Using VFO-B | 35 | VOX (Automatic TX/RX Switching using Voice Control) | 66 |
| “MY Bands” Operation | 36 | MONITOR | 67 |
| Band Stack Operation | 37 | Split Operation Using the TX Clarifier | 68 |
| C.S (Custom Switch) | 37 | Split-Frequency Operation | 69 |
| Rotator Control Functions | 38 | Quick Split Operation | 69 |
| More Frequency Navigation Techniques | 39 | | |
| Keyboard Frequency Entry | 39 | | |
| Using the [CLAR/VFO-B] knob | 39 | | |
| Using the UP/DOWN switches of | 39 | | |
| the supplied MH-31B8 Hand Microphone | 39 | | |

TABLE OF CONTENTS

| | | | |
|---|-----------|--|------------|
| CW Mode Operation | 70 | VFO and Memory Scanning | 97 |
| Setup for Straight Key | | VFO Scanning | 97 |
| (and Straight Key emulation) Operation | 70 | Memory Scan | 98 |
| Using the Built-in Electronic Keyer | 71 | PMS (Programmable Memory Scan) | 99 |
| Full Break-in (QSK) Operation | 72 | Packet Operation | 100 |
| Setting the Keyer Weight (Dot/Dash) Ratio | 72 | Packet Setup (Including Subcarrier Frequency) .. | 100 |
| Selecting the Keyer Operating Mode | 73 | Basic Setup | 100 |
| CW Convenience Features | 74 | RTTY (Radio Teletype) Operation | 101 |
| Audio Peak Filter | 74 | Setting Up for RTTY Operation | 101 |
| CW Spotting (Zero-Beating) | 75 | Basic Setup | 101 |
| Using CW Reverse | 76 | Miscellaneous AFSK-Based Data Modes | 102 |
| CW Delay Time Setting | 77 | Menu Mode | 104 |
| CW Pitch Adjustment | 77 | Using the Menu | 104 |
| Contest Memory Keyer | 78 | Menu Mode Reset | 104 |
| Message Memory | 78 | AGC Group | 108 |
| Transmitting in the Beacon Mode | 79 | DISPLAY Group | 108 |
| TEXT Memory | 80 | DVS Group | 109 |
| Contest Number Programming | 82 | KEYER Group | 109 |
| Contest Memory Keyer | | GENERAL Group | 110 |
| (Using the optional FH-2 Remote Control Keypad) | 82 | MODE-AM Group | 111 |
| Message Memory | 82 | MODE-CW Group | 111 |
| TEXT Memory | 84 | MODE-DATA Group | 113 |
| FM Mode Operation | 87 | MODE-FM Group | 113 |
| Basic Operation | 87 | MODE-RTTY Group | 113 |
| Repeater Operation | 88 | MODE-SSB Group | 114 |
| Tone Squelch Operation | 89 | RX GENERAL Group | 114 |
| Memory Operation | 90 | SCOPE Group | 115 |
| Convenient Memory functions | 90 | TUNING Group | 116 |
| QMB (Quick Memory Bank) | 91 | TX AUDIO Group | 116 |
| Standard Memory Operation | 92 | TX GNRL Group | 118 |
| Memory Storage | 92 | Installation of the Optional Filter | 120 |
| Memory Channel Recall | 92 | Voice Memory Unit (DVS-6) | 120 |
| Checking Memory Channel Status | 93 | RF μ Tuning Kit | 121 |
| Erasing Memory Channel Data | 93 | FC-40 External Automatic Antenna Tuner | 122 |
| Moving Memory Data to | | Data Management Unit (DMU-2000) | 124 |
| the Main Band (VFO-A) | 94 | Specifications | 126 |
| Memory Tune Operation | 94 | FCC Notice | 128 |
| Memory Groups | 95 | | |
| Memory Group Assignment | 95 | | |
| Choosing the Desired Memory Group | 95 | | |
| Operation on Alaska Emergency Frequency: | | | |
| 5167.5 kHz (U.S. Version Only) | 96 | | |

ACCESSORIES & OPTIONS

SUPPLIED ACCESSORIES

| | | |
|---------------------------|------|-----------|
| Hand Microphone (MH-31B8) | 1 pc | A07890001 |
| DC Power Cord | 1 pc | T9025225 |
| Spare Fuse (25A) | 1 pc | Q0000074 |
| Operating Manual | 1 pc | |
| Warranty Card | 1 pc | |

ACCESSORIES & OPTIONS

AVAILABLE OPTIONS

| | |
|--|--|
| MD-200A8X | Ultra-High-Fidelity Desktop Microphone |
| MD-100A8X | Desktop Microphone |
| YH-77STA | Lightweight Stereo Headphone |
| VL-1000/VP-1000 | Linear Amplifier/AC Power Supply |
| DMU-2000 | Data Management Unit |
| RF μTuning Kit A | For 160 m Band |
| RF μTuning Kit B | For 80/40 m Bands |
| RF μTuning Kit C | For 30/20 m Bands |
| FC-40 | External Automatic Antenna Tuner |
| DVS-6 | Voice Memory Unit |
| FH-2 | Remote Control Keypad |
| CT-118 | VL-1000 Linear Amplifier Connection Cable |
| CT Cable (MDIN6P - MDIN6P 2m) | Antenna Rotator Connection Cable (P/N T9101556) |
| CT Cable (MDIN10P - Bare Wire 2m) | Linear Amplifier Connection Cable (P/N T9207451) |

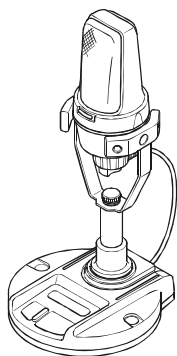

MD-200A8X



YH-77STA

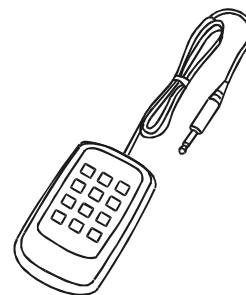

FH-2

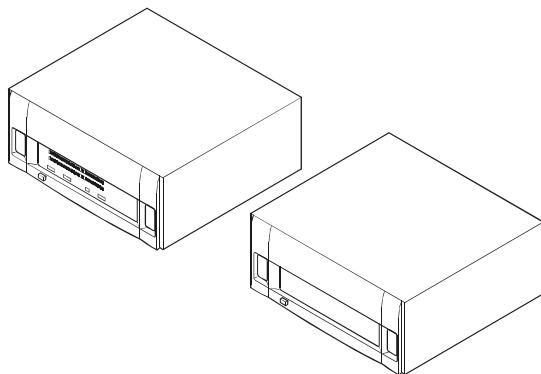

VL-1000/VP-1000

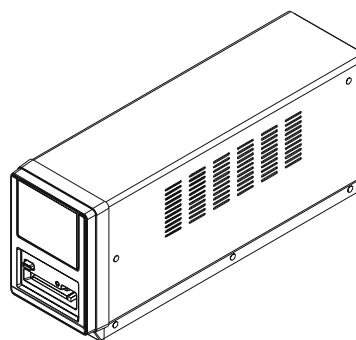

DMU-2000

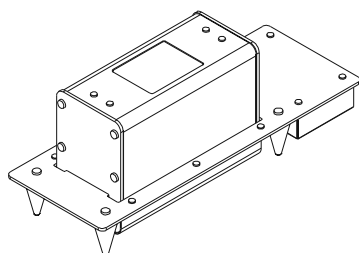

RF μ Tuning Kit

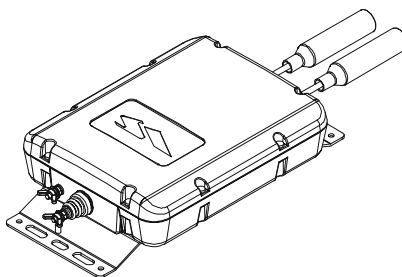

FC-40

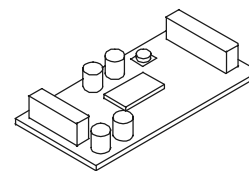

DVS-6

BEFORE YOU BEGIN

EXTENDING THE FRONT FEET

To elevate the front panel for easy viewing, the front left and right feet of the bottom case may be extended.

- Pull the front legs outward from the bottom panel.
- Rotate the legs counter-clockwise to lock them in the extended position. Be sure the legs have locked securely in place, because the transceiver is quite heavy and an unlocked leg could result in damage, should the transceiver move suddenly.

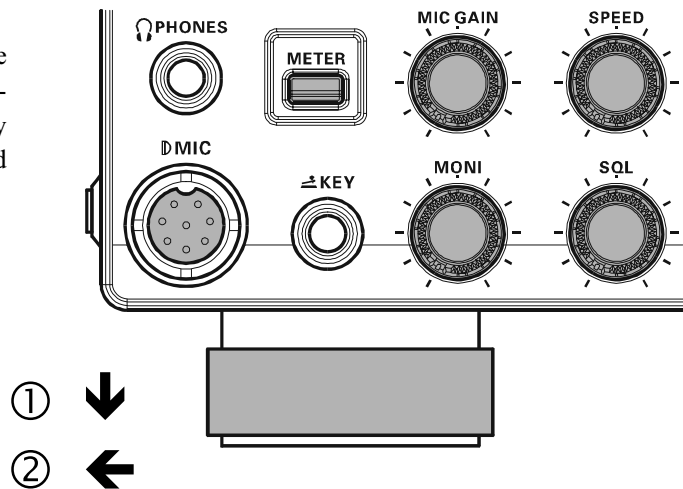

Retracting the Front Feet

- Rotate the legs clockwise, and push them inward while rotating to the right.
- The front feet should now be locked in the retracted position.

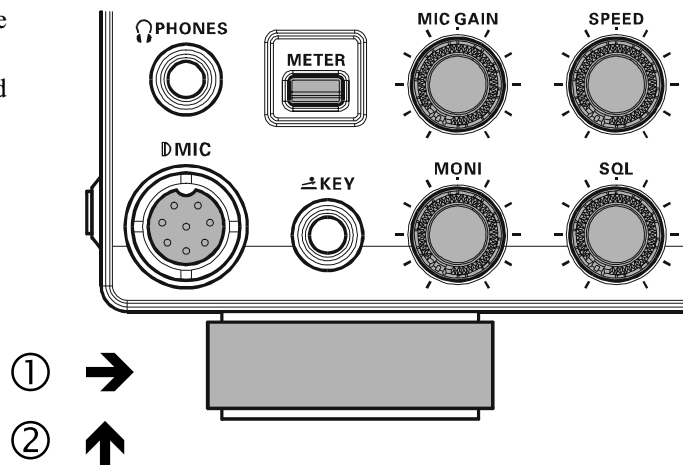

ADJUSTING THE MAIN TUNING DIAL TORQUE

The torque (drag) of the Main Tuning Dial knob may be adjusted according to your preferences. Simply hold down the rear skirt of the knob, and while holding it in place rotate the knob clockwise to reduce the drag or counter-clockwise to increase the drag.

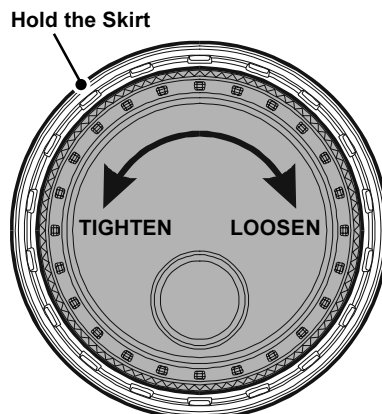

RESETTING THE MICROPROCESSOR

RESETTING MEMORIES (ONLY)

Use this procedure to reset (clear) the previously stored Memory channels, without affecting any configuration changes you may have made to the Menu settings.

1. Press the front panel's **[POWER]** switch to turn the transceiver off.
2. Press and hold in the **[A▶M]** button; while holding it in, press and hold in the front panel's **[POWER]** switch to turn the transceiver on. Once the transceiver comes on, you may release the buttons.

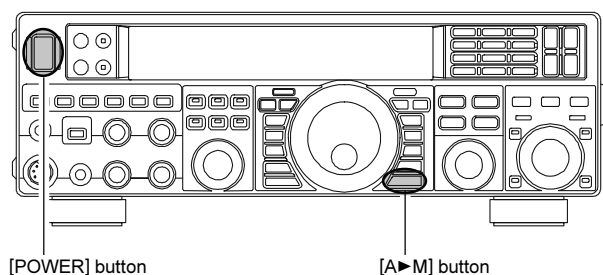

MENU RESETTING

Use this procedure to restore the Menu settings to their factory defaults, without affecting the memories you have programmed.

1. Press the front panel **[POWER]** switch to turn the transceiver off.
2. Press and hold in the **[MENU]** button; while holding it in, press and hold in the front panel **[POWER]** switch to turn the transceiver on. Once the transceiver comes on, you may release the buttons.

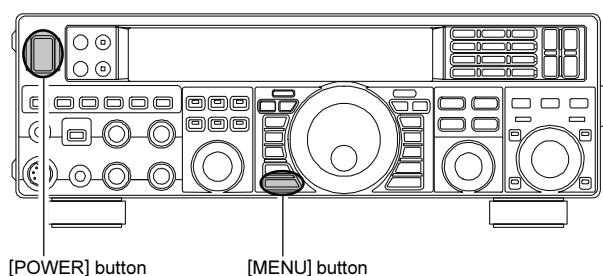

FULL RESET

Use this procedure to restore all Menu and Memory settings to their original factory defaults. All Memories will be cleared by this procedure.

1. Press the front panel **[POWER]** switch to turn the transceiver off.
2. Press and hold the **[FAST]** and **[LOCK]** buttons; while holding them in, press and hold in the front panel **[POWER]** switch to turn the transceiver on. Once the transceiver comes on, you may release the buttons.

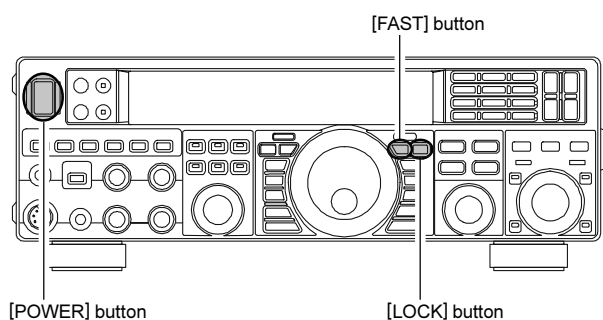

IMPORTANT NOTE:

When the optional μ Tuning Kit is connected to the **FT-950**, disconnect all the cables from the μ Tuning Kit before performing the Full Reset.

INSTALLATION AND INTERCONNECTIONS

ANTENNA CONSIDERATIONS

The **FT-950** is designed for use with any antenna system providing a 50 Ohm resistive impedance at the desired operating frequency. While minor excursions from the 50-Ohm specification are of no consequence, if the Standing Wave Ratio (SWR) present at the Antenna jack is greater than 3:1, the transceiver's Automatic Antenna Tuner may not be able to reduce the impedance mismatch to an acceptable value.

Every effort should be made to ensure that the impedance of the antenna system be as close as possible to the specified 50-Ohm value. Note that the "G5RV" type antenna does not provide a 50-Ohm impedance on all HF Amateur bands. An external wide-range antenna coupler must be used with this antenna type.

Any antenna to be used with the **FT-950** must be fed from the transceiver with 50 Ohm coaxial cable. Therefore, when using a "balanced" antenna such as a dipole, remember that a balun or other matching/balancing device must be used to ensure proper antenna performance.

The same precautions apply to any additional (receive-only) antennas connected to the antenna jacks; if your receive-only antennas do not have impedance near 50 Ohms at the operating frequency, you may need to install an external antenna tuner to obtain optimum performance.

ABOUT COAXIAL CABLE

Use high-quality 50-Ohm coaxial cable for the lead-in to your **FT-950** transceiver. All efforts at providing an efficient antenna system will be wasted if poor quality, lossy coaxial cable is used. This transceiver utilizes standard "M" ("PL-259") type connectors.

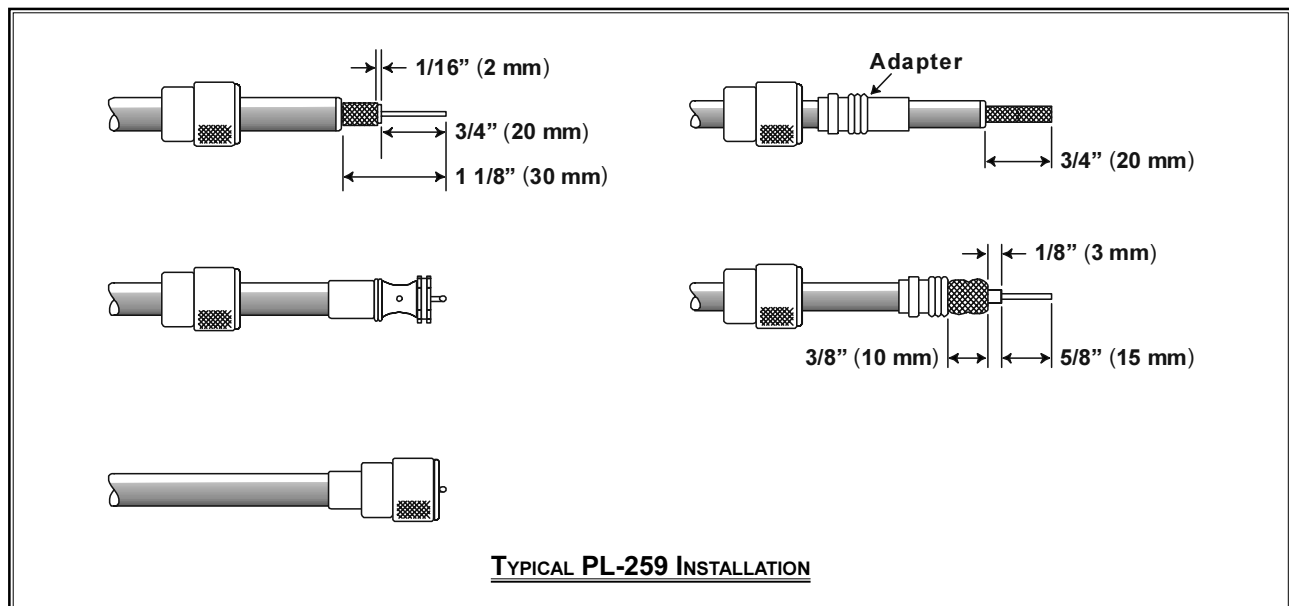

INSTALLATION AND INTERCONNECTIONS

GROUNDING

The **FT-950** transceiver, like any other HF communications apparatus, requires an effective ground system for maximum electrical safety and best communications effectiveness. A good ground system can contribute to station efficiency in a number of ways:

- ❑ It can minimize the possibility of electrical shock to the operator.
- ❑ It can minimize RF currents flowing on the shield of the coaxial cable and the chassis of the transceiver; such currents may lead to radiation, which can cause interference to home entertainment devices or laboratory test equipment.
- ❑ It can minimize the possibility of erratic transceiver/accessory operation caused by RF feedback and/or improper current flow through logic devices.

An effective earth ground system may take several forms; for a more complete discussion, see an appropriate RF engineering text. The information below is intended only as a guideline.

Typically, the ground connection consists of one or more copper-clad steel rods, driven into the ground. If multiple ground rods are used, they should be positioned in a “V” configuration, and bonded together at the base of the “V” which is nearest the station location. Use a heavy, braided cable (such as the discarded shield from type RG-213 coaxial cable), and strong cable clamps to secure the braided cable(s) to the ground rods. Be sure to weatherproof the connections to ensure many years of reliable service. Use the same type of heavy, braided cable for the connections to the station ground bus (described below).

Inside the station, a common ground bus consisting of a copper pipe of at least 25 mm diameter should be used. An alternative station ground bus may consist of a wide copper plate (single-sided circuit board material is ideal) secured to the bottom of the operating desk. Grounding connections from individual transceivers, power supplies, and data communications devices (TNCs, etc.) should be made directly to the ground bus using a heavy, braided cable.

Do not “Daisy-Chain” ground connections from one electrical device to another, and thence to the ground bus. This method may nullify any attempt at effective radio frequency grounding. See the drawing below for examples of proper grounding techniques.

Inspect the ground system - inside the station as well as outside - on a regular basis to ensure continued performance and safety.

Besides following the above guidelines carefully, note that household or industrial gas lines must never be used in an attempt to establish an electrical ground. Cold water pipes may, in some instances, help in the grounding effort, but gas lines represent a significant explosion hazard, and must never be used.

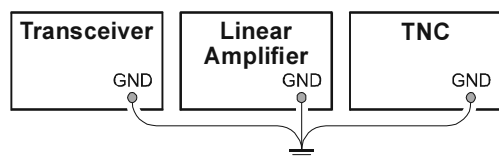

PROPER GROUND CONNECTION

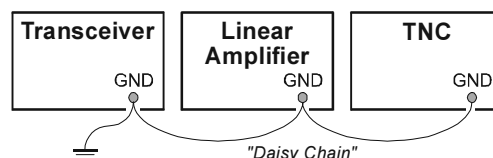

IMPROPER GROUND CONNECTION

INSTALLATION AND INTERCONNECTIONS

CONNECTION OF ANTENNA AND POWER CABLES

Please follow the outline in the illustration regarding the proper connection of antenna coaxial cables, as well as the DC power cable. The DC power connector for the **FT-950** must only be connected to a DC source providing 13.8 Volts DC ($\pm 10\%$), and capable of at least 22 Amperes of current. Always observe proper polarity when making DC connection:

The RED DC power lead connects to the Positive (+) DC terminal.

The BLACK DC power lead connects to the Negative (-) DC terminal.

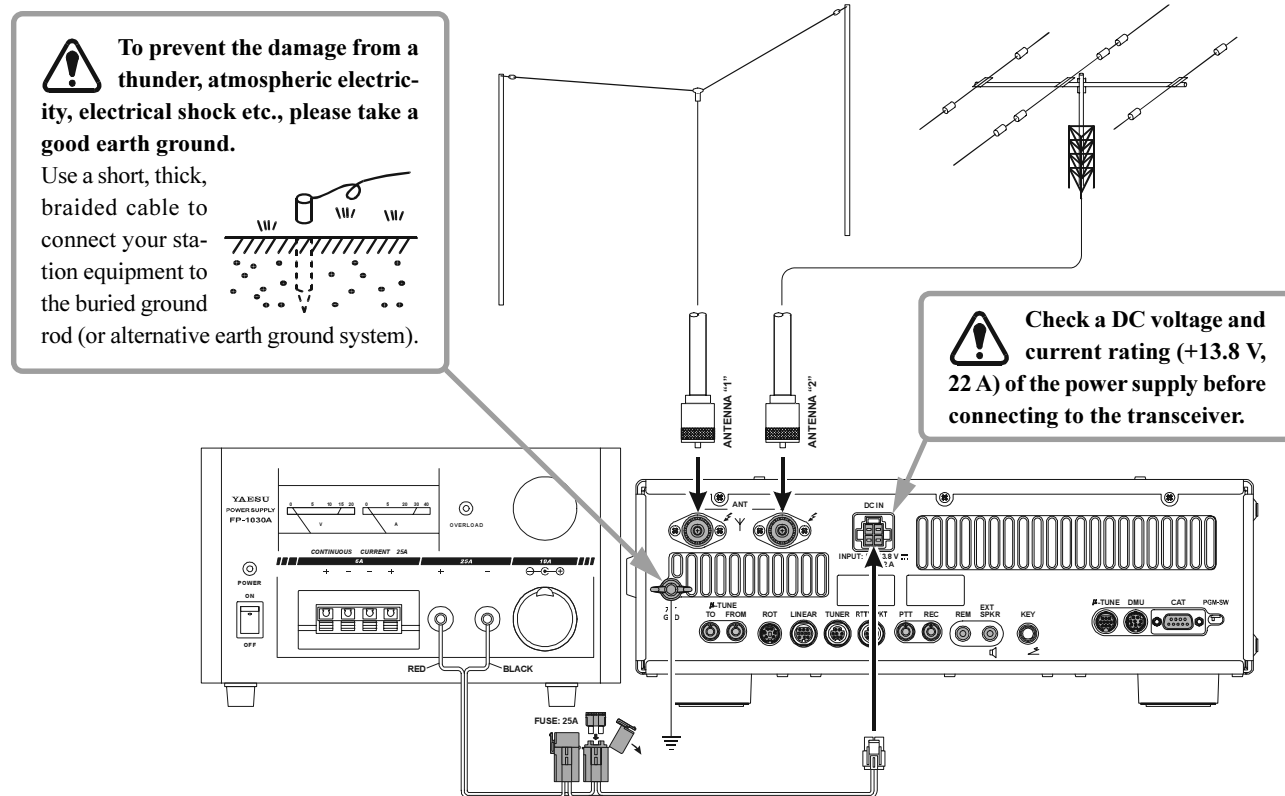

We recommend the use of the **FP-1030A** AC Power Supply. Other models of power supplies may be used with the **FT-950**, but the 13.8 VDC input voltage, 22-Ampere current capability, and DC cable polarity guidelines described above must be strictly followed.

Note that other manufacturers may use the same type of DC power connections as does your **FT-950** transceiver, however, the wiring configuration may be different from that specified for your transceiver. Serious damage can be caused if improper DC connections are made; consult with a qualified service technician when in doubt.

! Permanent damage can result when improper supply voltage, or reverse-polarity voltage, is applied to the **FT-950**. The Limited Warranty on this transceiver does not cover damage caused by application of AC voltage, reverse polarity DC, or DC voltage outside the specified range of 13.8 V $\pm 10\%$. When replacing fuses, be certain to use a fuse of the proper rating. The **FT-950** requires a 25 A blade fuse.

ADVICE:

- Do not position the **FT-950** in a location with direct exposure to sunshine.
- Do not position the **FT-950** in a location exposed to dust and/or high humidity.
- Ensure adequate ventilation around the **FT-950**, to prevent heat build-up and possible reduction of performance due to high heat.
- Do not install the **FT-950** on an unstable desk or table. Do not place in a location where objects may fall onto it from above.
- To minimize the possibility of interference to home entertainment devices, take all precautionary steps including separation of TV/FM antennas from Amateur transmitting antennas to the greatest extent possible, and keep transmitting coaxial cables separated from cables connected to home entertainment devices.
- Ensure that the DC power cord is not subject to undue stress or bending, which could damage the cable or cause it to be accidentally unplugged from the rear panel **DC IN** jack.
- Be certain to install your transmitting antenna(s) so they cannot possibly come in contact with TV/FM radio or other antennas, or with power or telephone lines.

INSTALLATION AND INTERCONNECTIONS

CONNECTION OF MICROPHONE AND HEADPHONE

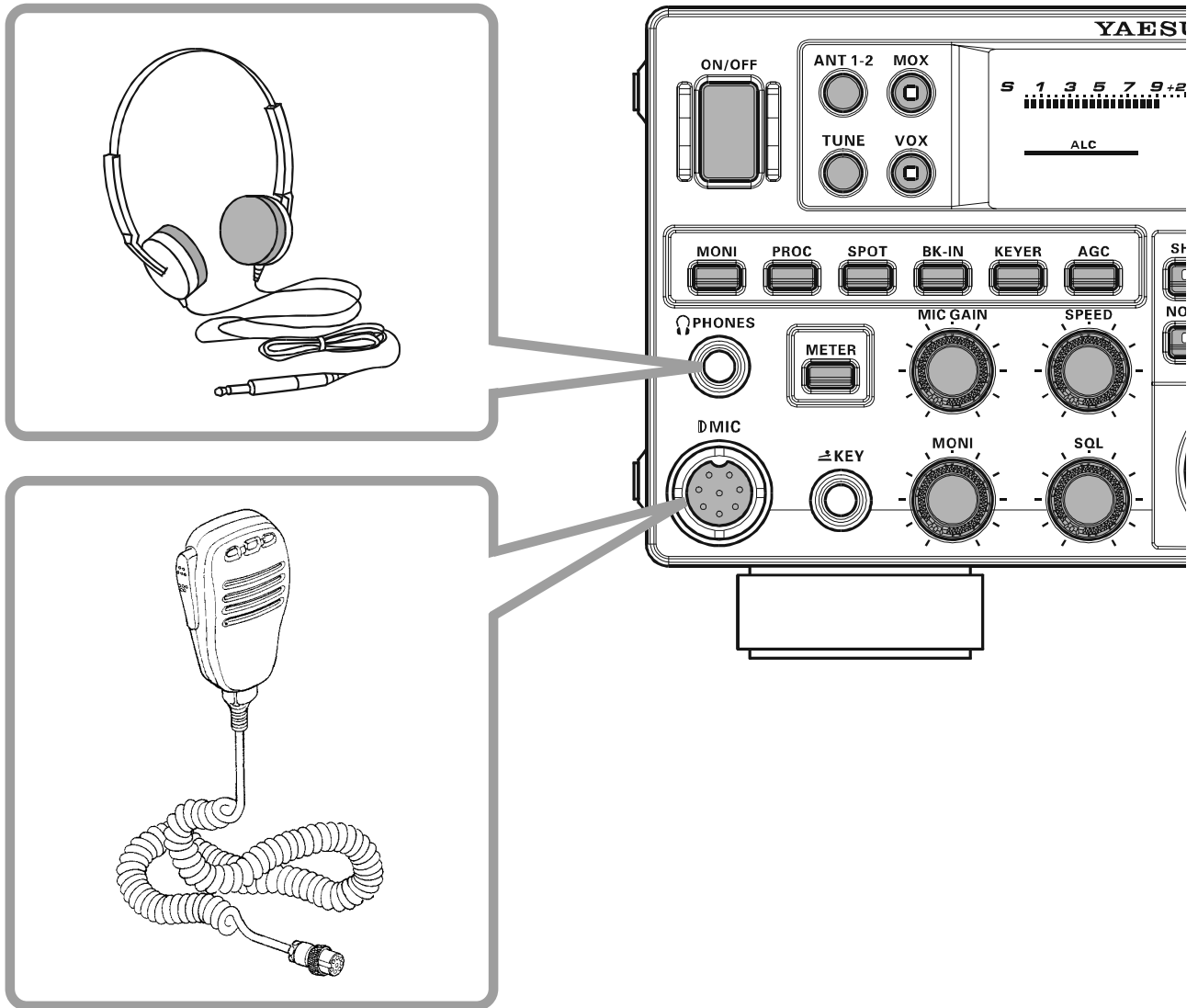

INSTALLATION AND INTERCONNECTIONS

KEY, KEYSER, AND COMPUTER-DRIVEN KEYING INTERCONNECTIONS

The **FT-950** includes many features for the CW operator. These functions will be detailed in the “Operation” section later. Besides the built-in Electronic Keyer, two key jacks are provided, one on the front and one on the rear panel, for convenient connection to keying devices.

The Menu selections allow you to configure the front and rear panel **KEY** jacks according to the device you wish to connect. For example, you may connect your keyer paddle to the front panel **KEY** jack, and use Menu item “037 A1A F-TYPE” for paddle input, and also connect the keying line from your personal computer (which emulates a “straight key”), to the rear panel **KEY** jack, and configure the rear panel jack using Menu item “039 A1A R-TYPE”.

Both **KEY** jacks on the **FT-950** utilize “Positive” keying voltage. Key-up voltage is approximately +3.3V DC, and key-down current is approximately 0.3 mA. When connecting a key or other device to the **KEY** jacks, use *only* a 3-contact (“stereo”) 1/4” phone plug; a 2-contact plug will place a short between the ring and (grounded) shaft of the plug, resulting in a constant “key-down” condition in some circumstances.

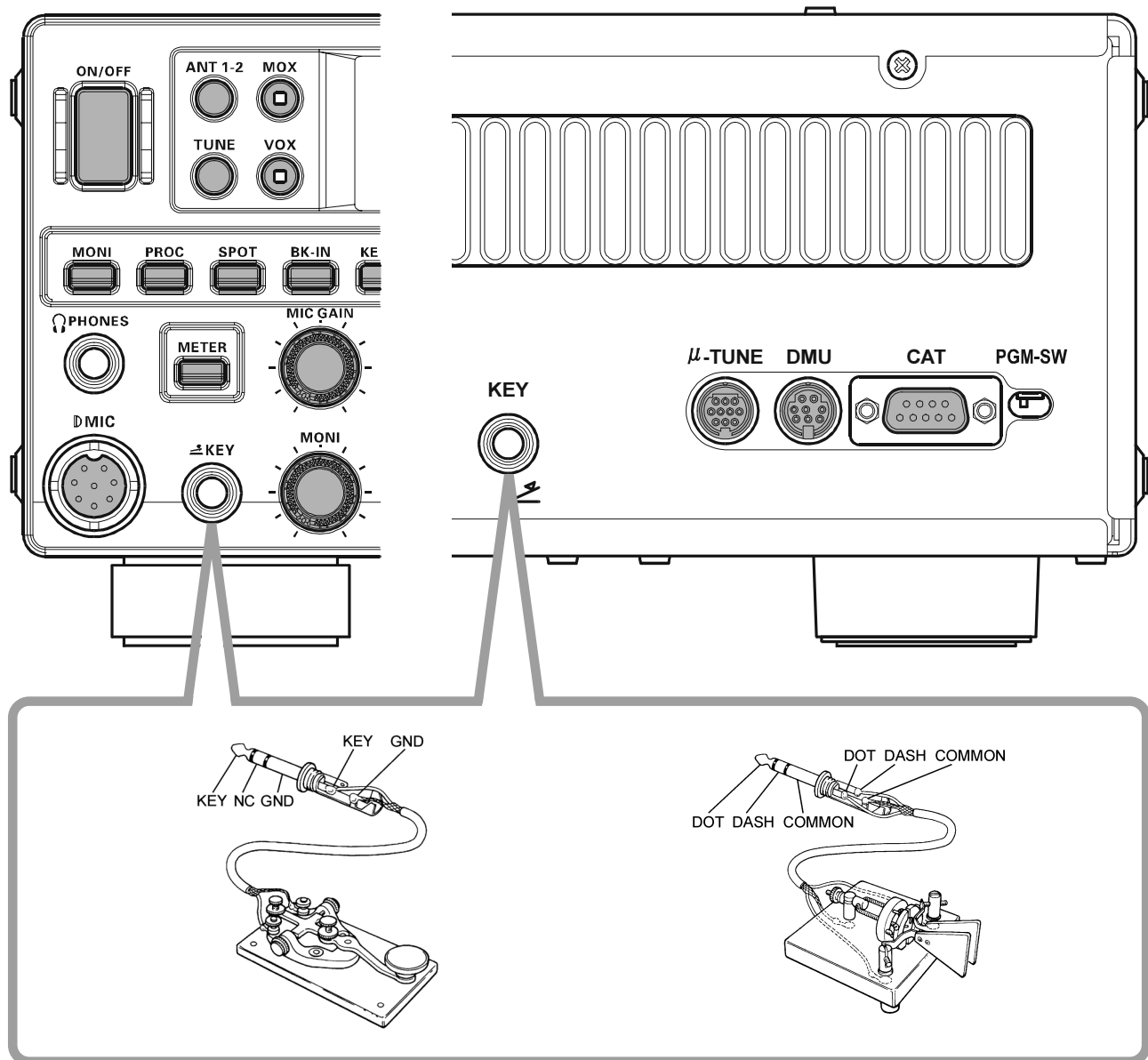

INSTALLATION AND INTERCONNECTIONS

VL-1000 LINEAR AMPLIFIER INTERCONNECTIONS

Be sure that both the **FT-950** and **VL-1000** are turned off, then follow the installation recommendations contained in the illustration.

NOTE:

- Please refer to the **VL-1000** Operating Manual for details regarding amplifier operation.
- Please do not attempt to connect or disconnect coaxial cables when your hands are wet.

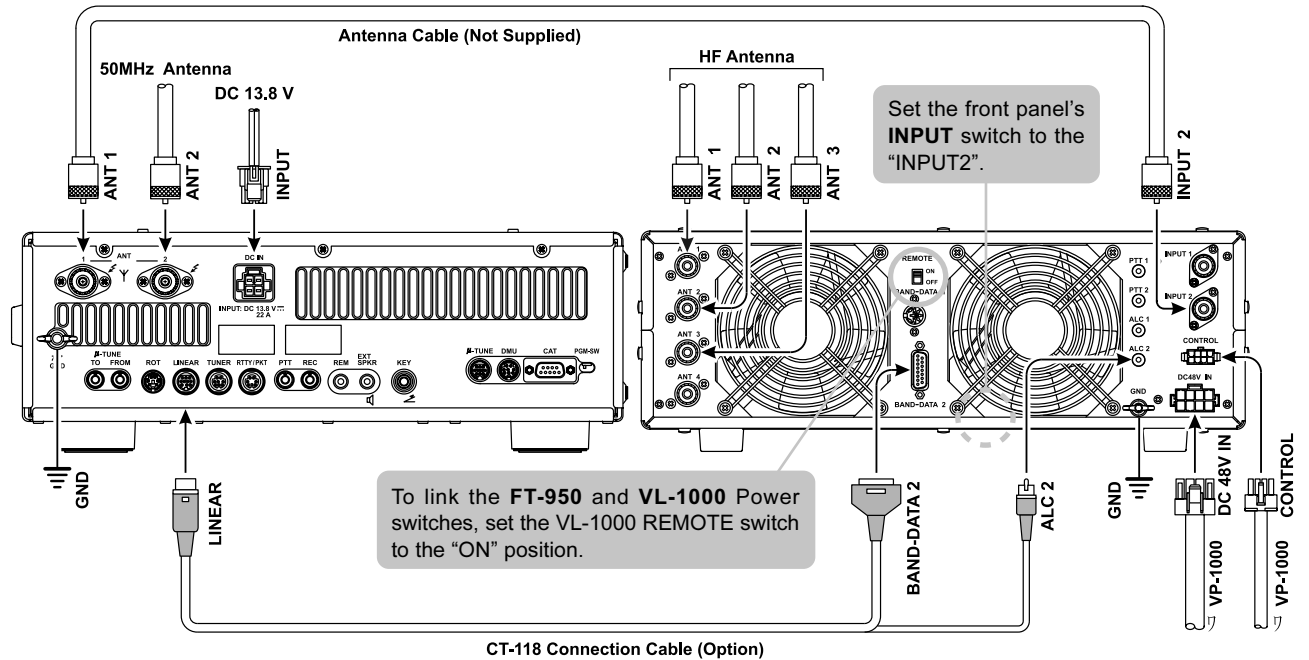

INSTALLATION AND INTERCONNECTIONS

INTERFACING TO OTHER LINEAR AMPLIFIERS

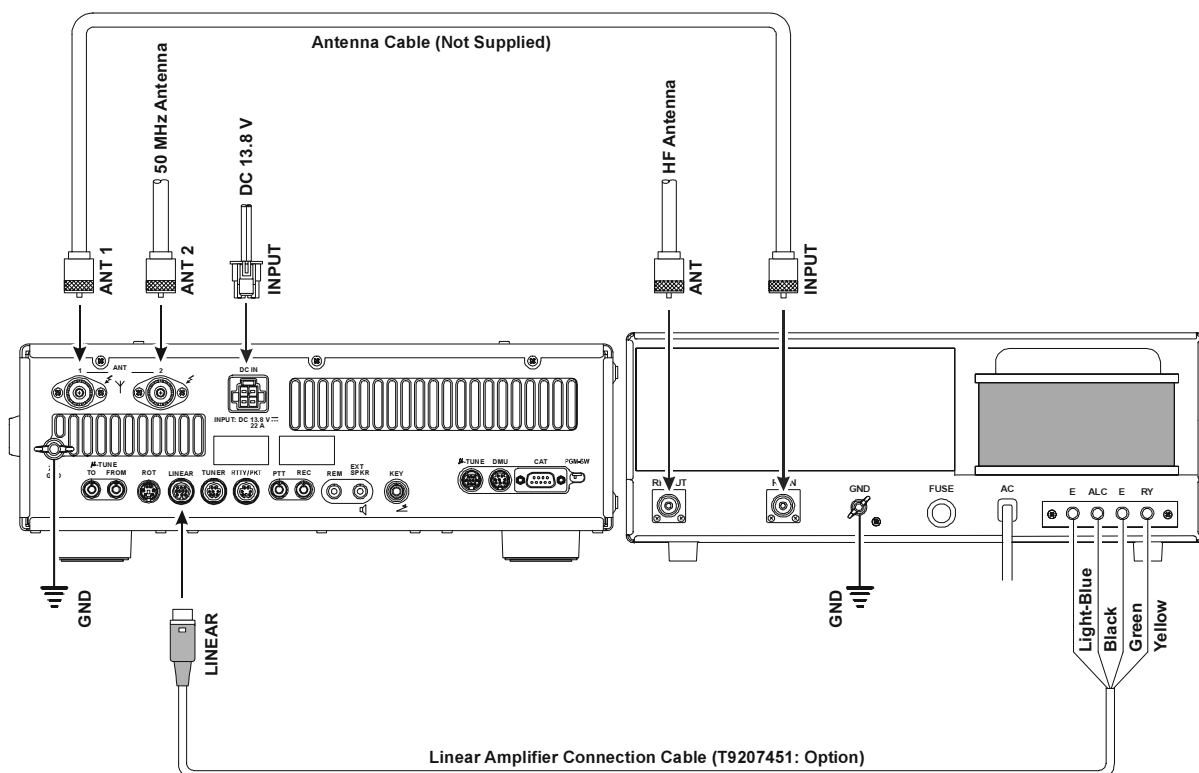

NOTE

- ❑ The TX GND OUT pin (pin 2) of the **LINEAR** jack is a transistor “open collector” circuit. It is capable of handling positive relay coil voltages up to +60VDC at 200 mA or +30 VDC at 1 A. If you plan to use multiple linear amplifiers for different bands, you must provide external band switching of the “Linear Tx” relay control line from the “TX GND OUT” line at the **LIN-EAR** jack.
- ❑ The specified range for ALC voltage to be used with the **FT-950** is 0 to -4 Volts DC.
- ❑ Amplifier systems utilizing different ALC voltages will not work correctly with the **FT-950**, and their ALC lines must not be connected if this is the case.

Note

When the **FC-40** is connected to the **FT-950**, TX GND (pin 2) of the **TUNER** jack and the **LINEAR** jack (pin 2) are common circuits.

Therefore, the maximum voltage at TX GND (pin 2) of the **LINEAR** jack must not exceed +5V.



IMPORTANT NOTE!

- ❑ Do not exceed the maximum voltage or current ratings for the “TX GND OUT” pin (pin 2) of the **LINEAR** jack. This line is not compatible with negative DC voltages, or AC voltages of any magnitude.
- ❑ Most amplifier control relay systems require only low DC voltage/current switching capability (typically, +12V DC at 25 ~ 75 mA), and the switching transistor in the **FT-950** will easily accommodate such amplifiers.

Linear Amplifier Connection Cable (T9207451)
Color Code Information

| Wire Color | LINEA Jack (Pin Number) | Function |
|------------|-------------------------|-------------|
| Orange | 1 | +13.8 V |
| Yellow | 2 | TX GND |
| Green | 3 | GND |
| Red | 4 | BAND DATA A |
| White | 5 | BAND DATA B |
| Blue | 6 | BAND DATA C |
| Violet | 7 | BAND DATA D |
| Brown | 8 | TX INH |
| Black | 9 | EXT ALC IN |
| Gray | 10 | TX REQ IN |
| Light Blue | Case | Shield |

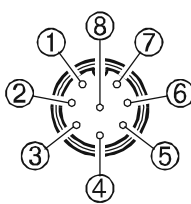
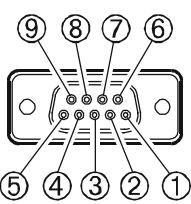
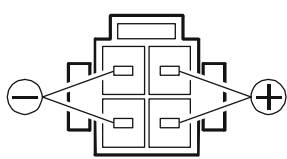
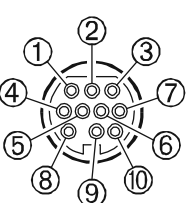
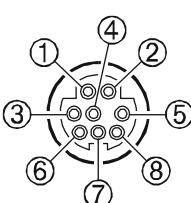
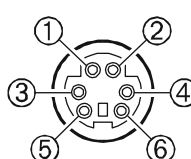
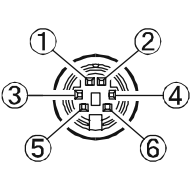
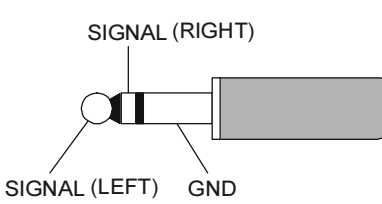
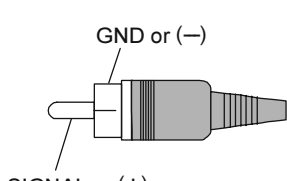
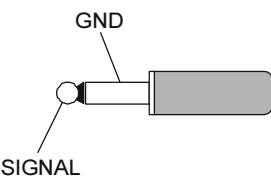
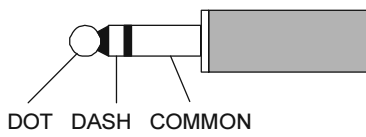
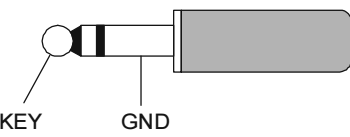
PLUG/CONNECTOR PINOUT DIAGRAMS

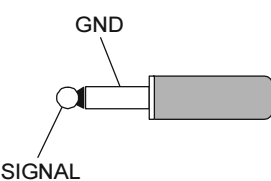
| MIC | CAT | DC IN |
|---|---|---|
|  <p>① UP ② +5V ③ DOWN ④ FAST ⑤ GND ⑥ PTT ⑦ MIC GND ⑧ MIC</p> <p>(as viewed from front panel)</p> |  <p>① N/A ② SERIAL OUT ③ SERIAL IN ④ N/A ⑤ GND ⑥ N/A ⑦ RTS ⑧ CTS ⑨ NC</p> <p>(as viewed from rear panel)</p> |  <p>(as viewed from rear panel)</p> |
| LINEAR | TUNER | RTTY/PKT |
|  <p>① +13V OUT ② TX GND ③ GND ④ BAND DATA A ⑤ BAND DATA B ⑥ BAND DATA C ⑦ BAND DATA D ⑧ TX INH ⑨ EXT ALC IN ⑩ TX REQ IN</p> <p>(as viewed from rear panel)</p> |  <p>① +13V OUT ② TX GND ③ GND ④ RX D ⑤ TX D ⑥ TUNER SENSE ⑦ RESET OUT ⑧ TX INH</p> <p>(as viewed from rear panel)</p> |  <p>① DATA IN ② GND ③ DATA PTT ④ FSK IN ⑤ DATA OUT ⑥ SQL OUT</p> <p>(as viewed from rear panel)</p> |
| ROT (ROTATOR) | PHONE | RCA PLUG |
|  <p>① CW ROTATION ② CCW ROTATION ③ SPEED ④ DIRECTION ⑤ GND ⑥ NC</p> <p>(as viewed from rear panel)</p> |  <p>SIGNAL (RIGHT) SIGNAL (LEFT) GND</p> |  <p>GND or (-) SIGNAL or (+)</p> |
| REM (REMOTE) | KEY | |
|  <p>GND SIGNAL</p> | <p><i>For Internal Keyer</i></p>  <p>DOT DASH COMMON</p> | <p><i>For Straight Key</i></p>  <p>KEY GND</p> <p> Do not use 2-conductor type plug</p> |
| EXT SPKR | <p>IMPORTANT NOTE:</p> <p>The μ-TUNE and DMU connectors are special connectors for this transceiver. Please do not connect any accessory or other device not specifically approved by Vertex Standard. Failure to observe this precaution may cause damage not covered by the Limited Warranty on this apparatus.</p> | |
|  <p>GND SIGNAL</p> | | |

FRONT PANEL CONTROLS & SWITCHES

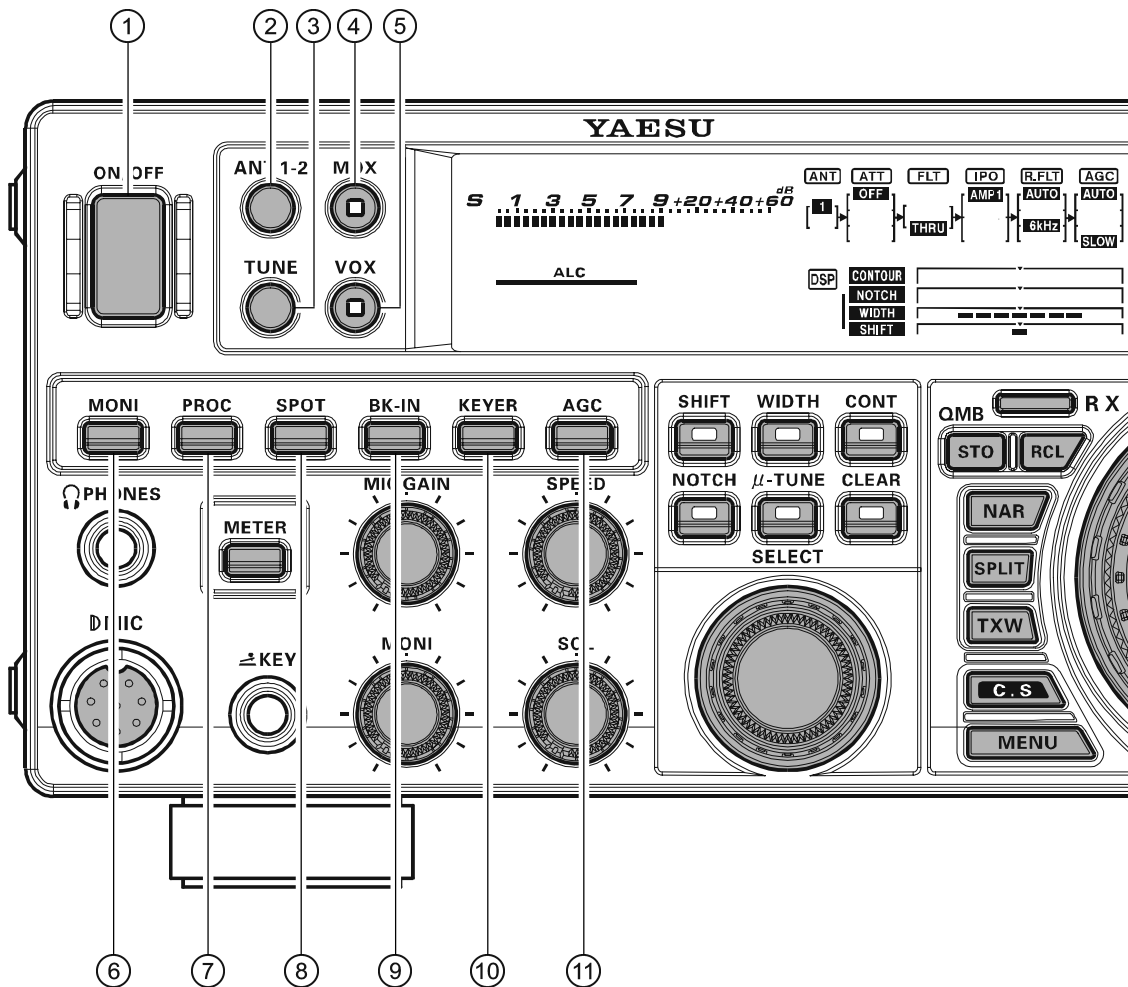

① [POWER] Switch

Press and hold in this switch for two seconds to turn the transceiver on. Similarly, press and hold in this switch for two seconds to turn the transceiver off.

② [ANT 1-2] Switch

Pressing this switch selects the **ANT 1** or the **ANT 2** connector on the rear panel, and allows convenient antenna switching at the press of button. The selected antenna jack is indicated on the Block Diagram Display shown in the Transceiver Display.

③ [TUNE] Switch

This is the on/off switch for the **FT-950**'s Automatic Antenna Tuner.

Pressing this button momentarily places the antenna tuner in line between the transmitter final amplifier and the antenna jack (The "**TUNER**" icon will appear in the display). Reception is not affected.

Pressing and holding in this button for two seconds, while receiving in an amateur band, activates the transmitter for a few seconds while the automatic antenna tuner rematches the antenna system impedance for minimum SWR. The resulting setting is automatically stored in one of the antenna tuner's 100 memories, for instant automatic recall later when the receiver is tuned near the same frequency.

Pressing this button momentarily, while the Tuner is engaged, will take the Automatic Antenna tuner out of the transmit line.

NOTE:

When the Automatic Antenna Tuner is tuning itself, a signal is being transmitted. Therefore, be certain that an antenna or dummy load is connected to the selected antenna jack before pressing and holding in the **[TUNE]** button to start antenna tuning.

FRONT PANEL CONTROLS & SWITCHES

④ [MOX] Switch

Pressing this button engages the PTT (Push to Talk) circuit, to activate the transmitter (the LED inside this button will glow red). It must be turned off (the red LED will be off) for reception. This button replicates the action of the Push to Talk (PTT) switch on the microphone. When engaging the [MOX] button, or otherwise causing a transmission to be started, be certain you have either an antenna or 50-Ohm dummy load connected to the selected Antenna jack.

⑤ [VOX] Switch

This button enables automatic voice-actuated transmitter switching in the SSB, AM, and FM modes. While activated, the LED inside this button glows red. The controls affecting VOX operation are the Menu items “114 TGEN V GAIN”, “115 TGEN VOX DLY”, and “116 TGEN ANTI VOX”. By proper adjustment of these controls, hands-free voice-actuated operation is possible.

⑥ [MONI] (Monitor) Switch

This button enables the transmit monitor in all modes. While activated, the “[MONI]” icon appears in the display. The Monitor audio level may be adjusted by turning the [MONI] knob.

ADVICE:

When using headphones, the Monitor function is very helpful while adjusting the Parametric Equalizer or other voice quality adjustments. The voice heard in the headphones represents the transmitted audio qualities.

⑦ [PROC] (Processor) Switch

This button enables the Parametric Microphone Equalizer and Speech Processor for SSB/AM transmission. When the Parametric Microphone Equalizer is activated, the “[MICEQ]” icon appears in the display. When the Speech Processor is activated, the “[MICEQ]” and “[PROC]” icons appear in the display. Adjustment of the Processor level is accomplished via the Menu item “109 TGEN PROCLVL”.

ADVICE:

- The Speech Processor is a tool for increasing the average power output through a compression technique. However, if the Processor level is advanced too far, the increase in compression becomes counter-productive, as intelligibility will suffer. We recommend that you monitor the sound of your signal using the Monitor (with headphones).
- When the optional Data Management Unit (**DMU-2000**) is connected, you may use the Audio Scope/Oscilloscope page to help you adjust the setting of the compression level of the Speech Processor for optimum performance using your voice and microphone.

⑧ [SPOT] Switch

This button turns on the CW receiver spotting tone; by matching the SPOT tone to that of the incoming CW signal (precisely the same pitch), you will be “zero beating” your transmitted signal on to the frequency of the other station.

The offset tone frequency will be indicated in the frequency display area of the display while this button is pressed.

⑨ [BK-IN] Switch

This button turns the CW break-in capability on and off. While CW break-in is activated, the “[BK-IN]” icon appears in the display.

⑩ [KEYER] Switch

This button toggles the internal CW keyer on and off. While activated, the “[KEYER]” icon appears in the display. The Keyer sending speed is adjusted via the front panel’s [SPEED] knob and the CW Hang Time is adjusted via the Menu item “044 A1A DELAY”.

⑪ [AGC] Switch

This button selects the AGC characteristics for the receiver. Available selections are FAST, MID, SLOW, or AUTO. The “AGC” icon will change according to the AGC characteristics selected.

Press the [AGC] button repeatedly to select the desired receiver-recovery time constant. Press and hold in the [AGC] button for two seconds to disable the AGC (for testing or weak-signal reception).

ADVICE:

- The Attenuator may be used in conjunction with the [IPO] button to provide two stages of signal reduction when an extremely strong signal is being received.
- If the AGC receiver-recovery time is set to “Off” by pressing and holding in the [AGC] button, the S-meter will no longer deflect. Additionally, you will likely encounter distortion on stronger signals, as the IF amplifiers and the following stages are probably being overloaded.

FRONT PANEL CONTROLS & SWITCHES

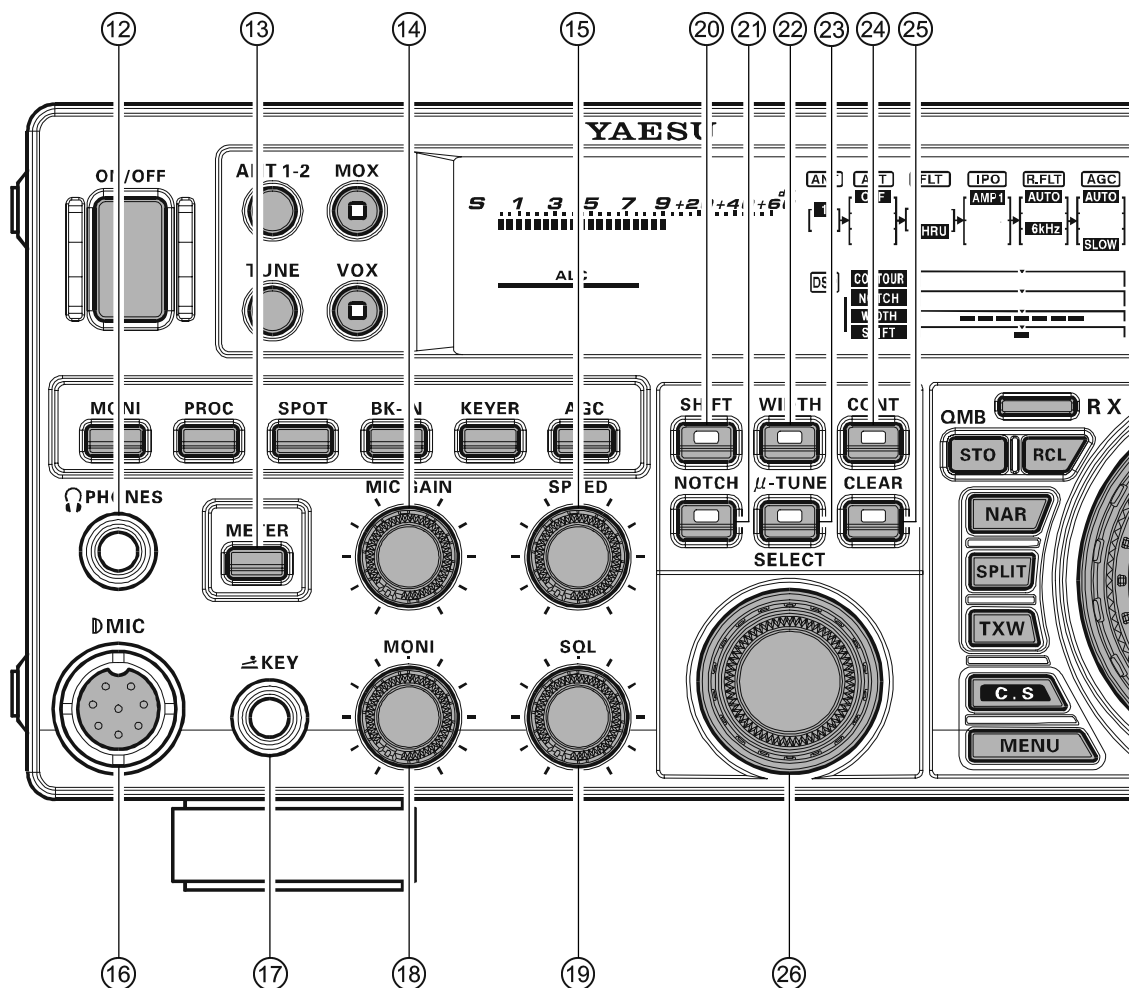

⑫ PHONES Jack

A 1/4-inch, 3-contact jack accepts either monaural or stereo headphones with 2- or 3-contact plugs. When a plug is inserted, the loudspeaker is disabled.

NOTE:

When wearing headphones, we recommend that you turn the AF Gain levels down to their lowest settings before turning power on, to minimize the impact on your hearing caused by audio “pops” during switch-on.

⑬ [METER] Switch

This button determines the function of the meter during transmission.

Press this button to change the meter function in the transmit mode as follows:

ALC → SWR → ID → VDD → COMP → ALC ……

ALC: Indicates the relative ALC voltage.

SWR: Indicates the Standing Wave Ratio (Forward/Reflected).

ID: Indicates the final amplifier drain current.

VDD: Indicates the final amplifier drain voltage.

COMP: Indicates the speech compressor level (SSB/AM modes only).

⑭ [MIC GAIN] Knob

This knob adjusts the microphone input level for (non-processed) SSB and AM transmission.

The frequency display will show the relative microphone gain level for 3 seconds whenever this knob is turned.

ADVICE:

Adjust the [MIC GAIN] knob while speaking in a somewhat louder than normal voice level, watch the ALC level and adjust the [MIC GAIN] knob so that the ALC level indication just reaches the right edge of the ALC scale. Then, when you speak in your normal voice level, you will not be over-driving the microphone amplifier stages.

⑮ [SPEED] Knob

This knob adjusts the keying speed of the internal CW keyer (4 ~ 60 WPM). Clockwise rotation increases the sending speed.

The frequency display will show the keying speed for 3 seconds whenever this knob is turned.

⑯ Microphone Connector

This 8-pin jack accepts input from a microphone utilizing a traditional YAESU HF transceiver pinout.

FRONT PANEL CONTROLS & SWITCHES

17 KEY Jack

This 1/4-inch, 3-contact jack accepts a CW key or keyer paddles (for the built-in electronic keyer), or output from an external electronic keyer. Pinout is shown on page 15. Key up voltage is +3.3 V DC, and key down current is 0.3 mA. This jack may be configured for keyer, “Bug”, “straight key”, or computer keying interface operation via Menu item “O37 A1A F-TYPE” (see page 111). There is another jack with the same name on the rear panel, and it may be configured independently for Internal Keyer or pseudo-straight-key operation.

NOTE:

You cannot use a 2-contact plug in this jack (to do so produces a constant “key down” condition).

18 [MONI] Knob

This knob adjusts the audio level of the transmit monitor during transmission, when activated by the [MONI] button.

19 [SQL] Knob

This knob sets the signal level threshold, below which the receiver audio is muted, in all modes. It is very useful during local rag-chews, to eliminate noise between incoming transmissions. This control is normally kept fully counter-clockwise (off), except when scanning and during FM operation.

20 [SHIFT] Switch

Pressing this button allows you to move the IF DSP Bandwidth higher or lower, using the [SELECT] knob. While activated, the LED inside this button glows orange.

21 [NOTCH] Switch

Pressing this button allows you to adjust the center frequency of the IF Notch filter using the [SELECT] knob. While activated, the LED inside this button glows orange. Press the [SELECT] knob briefly to toggle the IF Notch filter on/off.

22 [WIDTH] Switch

Pressing this button allows you to adjust the overall bandwidth of the IF DSP filter using the [SELECT] knob. While activated, the LED inside this button glows orange.

23 [μ-TUNE] Switch

Pressing this button allows you to adjust the center frequency of the μ-Tuning filter passband using the [SELECT] knob, when the optional RF μTuning Kit is connected. While activated, the LED inside this button glows orange. Press the [SELECT] knob briefly to toggle the μ-Tuning function on/off.

24 [CONT] Switch

Pressing this button allows you to select the DSP Contour filter response using the [SELECT] knob. While activated, the LED inside this button glows orange. Press the [SELECT] knob briefly to toggle the IF Contour filter on/off.

Furthermore, in the CW mode, press and hold this button for 2 seconds to activate the APF (Audio Peak Filter) which provides a very narrow audio bandwidth.

The APF circuit is an automatic circuit, and there is no adjustment knob for the APF.

25 [CLEAR] Switch

Pressing this button will reset to factory default the functions, which are selected with the five buttons at the left of this button.

26 [SELECT] Knob

This knob is used to adjust the status of the functions selected by the five buttons located above the knob.

| FUNCTION SWITCH | EFFECT |
|-----------------|---|
| [SHIFT] | Rotate the [SELECT] knob to move the passband of the IF DSP filter by 20 Hz steps. The total adjustment range is ±1 kHz. The position of the passband can be observed on the display. Furthermore, the frequency display will show the shift value of the IF SHIFT for 3 seconds whenever the [SELECT] knob is turned. |
| [WIDTH] | Rotate the [SELECT] knob to set the overall bandwidth of the IF DSP filter. Counter-clockwise rotation reduces the bandwidth, while clockwise rotation increases the bandwidth. The current bandwidth can be observed on the display. Furthermore, the frequency display will show the bandwidth of the IF passband for 3 seconds whenever the [SELECT] knob is turned. |
| [CONT] | Press the [SELECT] knob to turn the CONTOUR filter on and off. Rotate the [SELECT] knob to adjust the CONTOUR filter response. The peak position of the CONTOUR filter can be observed on the display. Furthermore, the frequency display will show the CONTOUR frequency for 3 seconds whenever the [SELECT] knob is turned. |
| [NOTCH] | Press the [SELECT] knob to turn the IF NOTCH filter on and off. Rotate the [SELECT] knob to adjust the center frequency of the IF NOTCH filter. The null position of the IF NOTCH filter can be observed on the display. Furthermore, the frequency display will show the center frequency of the IF NOTCH filter for 3 seconds whenever the [SELECT] knob is turned. |
| [μ-TUNE] | Press the [SELECT] knob to turn the optional RF μTuning Kit on and off. Rotate the [SELECT] knob to adjust the center frequency of the μ-Tuning filter. The peak position of the μ-Tuning filter can be observed on the Tuning Offset Indicator field of the display. |

If the [SELECT] knob is turned too slowly, the frequency display may not show the value. This is to prevent undesired display of the functions caused by noise or slight vibration of the controls; however, the actual value will be changed even if not displayed.

You can observe the fine adjustment for a few seconds while the display is active.

While adjusting functions, the display may occasionally skip one of the numbers in the sequence; this is due to “rounding” of the encoder steps in the ADC converter. Set the values to your preference, they are unique to your radio and may not directly correspond to other units.

The [SELECT] knob is also used to select the Menu item when the Menu mode is engaged.

Press and hold the [SELECT] knob for one second to activate the optional Voice Memory feature for the SSB/AM/FM modes, or the Contest Keyer for the CW mode. See page 64 (Voice Memory feature) or page 78 (Contest Keyer) for details.

FRONT PANEL CONTROLS & SWITCHES

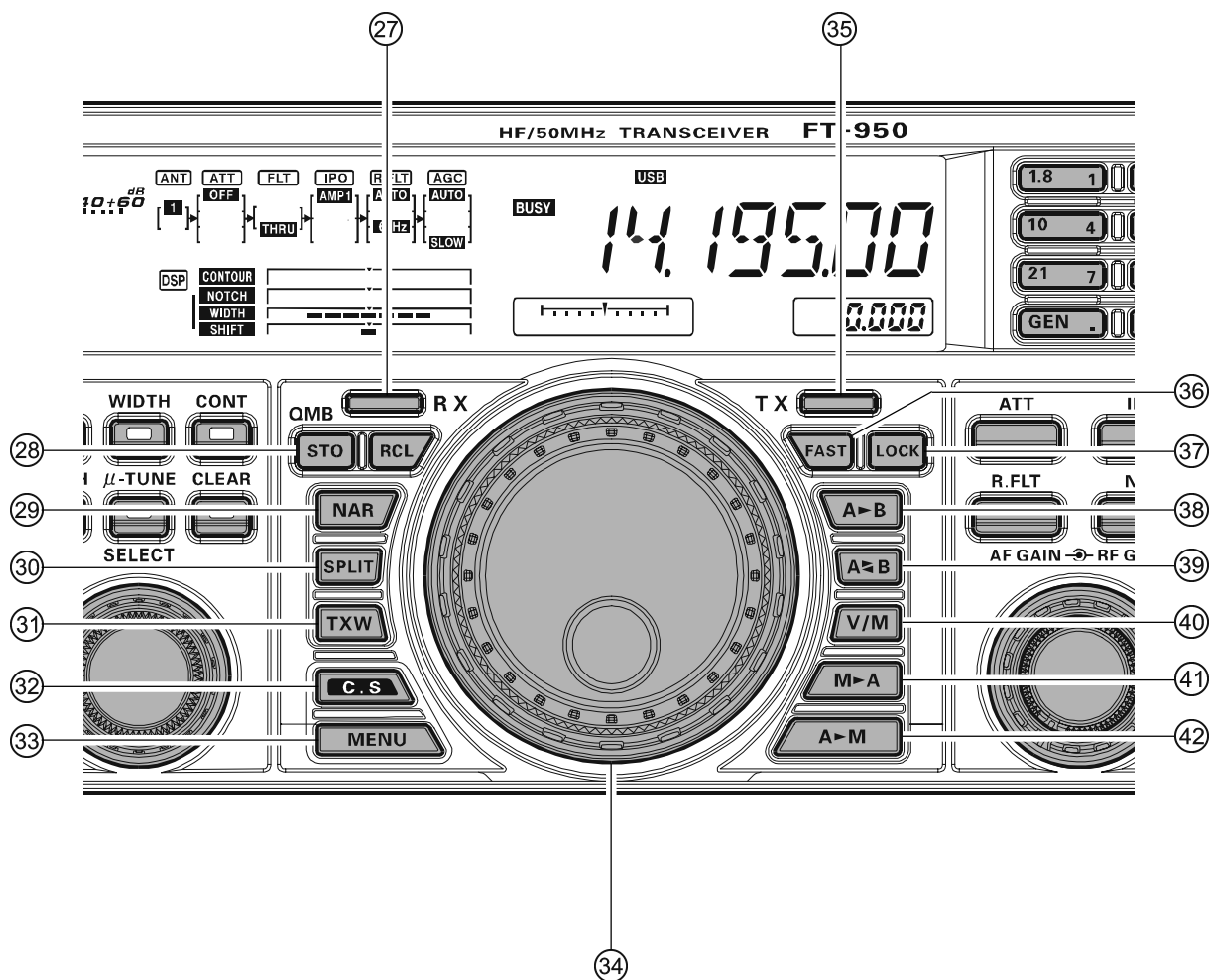

27 [(VFO-A)RX] Indicator/Switch

Press this button to activate receive on the VFO-A frequency. The LED inside the button will glow green when the transceiver receives the VFO-A frequency.

When the transceiver receives the VFO-A frequency, pressing this button momentarily will mute the receiver, and the indicator will blink. Pressing the button once more will restore receiver operation, and the indicator will glow green steadily.

28 QMB (Quick Memory Bank) Switches

[STO] (Store) Button

Pressing the [STO] button copies the contents (frequency, mode, bandwidth, and also FM repeater frequency shift/direction and CTCSS functions) of VFO-A, into consecutive QMB Memories.

[RCL] (Recall) Button

Pressing the [RCL] button, recalls one of up to five Quick Memory Bank memories for operation.

29 [NAR] (Narrow) Switch

In the SSB/CW/RTTY/PSK modes, this button is used to set the DSP (digital) IF filters to Narrow bandwidth.

ADVICE:

You may adjust the bandwidth using the [SELECT] knob when the [WIDTH] button is engaged.

In the AM mode, this button is used to toggle the receiver's bandwidth between wide (9 kHz) and narrow (6 kHz).

In the FM mode on the 28 MHz and 50 MHz bands, this button is used to toggle the FM deviation/bandwidth between wide (± 5.0 kHz Dev./25.0 kHz BW) and narrow (± 2.5 kHz Dev./12.5 kHz BW).

30 [SPLIT] Switch

Press this button to operate split frequency between VFO-A (used for reception) and VFO-B (used for transmission). If you press and hold in the [SPLIT] button for one second, the "Quick Split" feature will be engaged. VFO-B will automatically be set to a frequency 5 kHz higher than the VFO-A frequency, with the same operating mode. The transceiver will be placed in the Split mode.

FRONT PANEL CONTROLS & SWITCHES

③① [TXW] (TX Watch) Switch

Pressing this button lets you monitor the transmit frequency when split frequency operation is engaged. Release the button to return to normal split frequency operation.

③② [C.S] Switch

Press this button momentarily to directly recall a favorite Menu Selection.

To program a Menu selection to the [C.S] button: press the [MENU] button to enter the Menu. Select the Menu item you want to set as the short cut. Then press and hold in the [C.S] button for one second; this will lock in the selected Menu item as the short cut.

③③ [MENU] Switch

This button is used to access the Menu system. The various transceiver characteristics may be configured. Menu operation is described in detail, in this manual, beginning on page 104.

IMPORTANT NOTE:

Pressing this button momentarily, activates the Menu. The Menu items will appear on the display; once you have changed the parameters, you must press and hold in the [MENU] button for one second to save any configuration changes (momentarily pressing the [MENU] button to exit will not save the changes).

③④ Main Tuning Dial Knob

This large knob adjusts the operating frequency of the VFO-A or a recalled memory. Clockwise rotation of this knob increases the frequency. Default tuning increments are 10 Hz (100 Hz in AM and FM modes); when the [FAST] button is pressed, the tuning steps increase. The available steps are:

| OPERATING MODE | 1 STEP | 1 DIAL ROTATION |
|--------------------------|----------------|------------------|
| LSB/USB/CW/RTTY/PKT(LSB) | 10 Hz (100 Hz) | 10 kHz (100 kHz) |
| AM/FM/PKT(FM) | 100 Hz (1 kHz) | 100 kHz (1 MHz) |

Numbers in parentheses indicate steps when the [FAST] button is On.

ADVICE:

The tuning steps for the Main Tuning Dial knob are set, at the factory, to 10 Hz per step. Via Menu item "084 TUN DIALSTP", however, you may change this setting from 10 Hz to 1 or 5 Hz instead.

③⑤ [(VFO-A)TX] Indicator/Switch

When this button is pushed, the LED inside the button will glow red; and, when the PTT switch is pressed, the transceiver will transmit on the VFO-A frequency (subject to any Clarifier offset, of course).

ADVICE:

If this indicator is not illuminated, it means the [(VFO-B)TX] Indicator/Switch has been selected (it will be glowing red). In this case, transmission will be on the frequency and mode programmed for VFO-B.

③⑥ [FAST] Switch

Pressing this button will change the tuning rate of the Main Tuning Dial knob (VFO-A) or the VFO-B Tuning Knob ([CLAR/VFO-B] knob) to 100 Hz/step. When this function is activated, the "[FAST]" icon appears in the display.

ADVICE:

This switch affects VFO-A and VFO-B independently.

③⑦ [LOCK] Switch

This button toggles locking on/off for the Main Tuning Dial knob (VFO-A) or the VFO-B Tuning Knob ([CLAR/VFO-B] knob). With "Lcok" on, the Main Tuning Dial knob or [CLAR/VFO-B] knob can still be turned, but the frequency will not change, and the "[LOCK]" icon appears in the display.

ADVICE:

This switch locks VFO-A and VFO-B independently.

③⑧ [A▶B] Switch

Press this button momentarily to transfer the frequency or memory channel data, from VFO-A to VFO-B, overwriting any previous contents in VFO-B. Use this key to set both VFO-A and VFO-B to the same frequency and mode.

③⑨ [A↔B] Switch

Pressing this button momentarily, exchanges the frequency or memory channel data, of VFO-A and VFO-B.

④① [V/M] Switch

This button toggles frequency control between VFO-A and the memory system. In memory mode, either "[MR]" or "[MT]" icon will be shown under the frequency Display field to indicate the current selection. If you have tuned the frequency off the Memory channel, the "[MT]" icon will be displayed. Pressing the [V/M] button returns the display to the original memory frequency, and the "[MR]" icon will again be displayed. Pressing it once more returns frequency operation to the VFO-A, and the icon will no longer be displayed.

④① [M▶A] Switch

Pressing this button momentarily, will display the contents of the currently-selected memory channel for 10 seconds.

Holding [M▶A] button in for one second copies the data from the selected memory to VFO-A, and two beeps sound. Previous data in VFO-A will be overwritten.

④② [A▶M] Switch

Pressing this button momentarily, displays the contents of the currently-selected memory channel for 10 seconds. Pressing and holding in this key for one second (until the double beep) copies the current operating data into the currently selected memory channel, overwriting any previous data stored there.

FRONT PANEL CONTROLS & SWITCHES

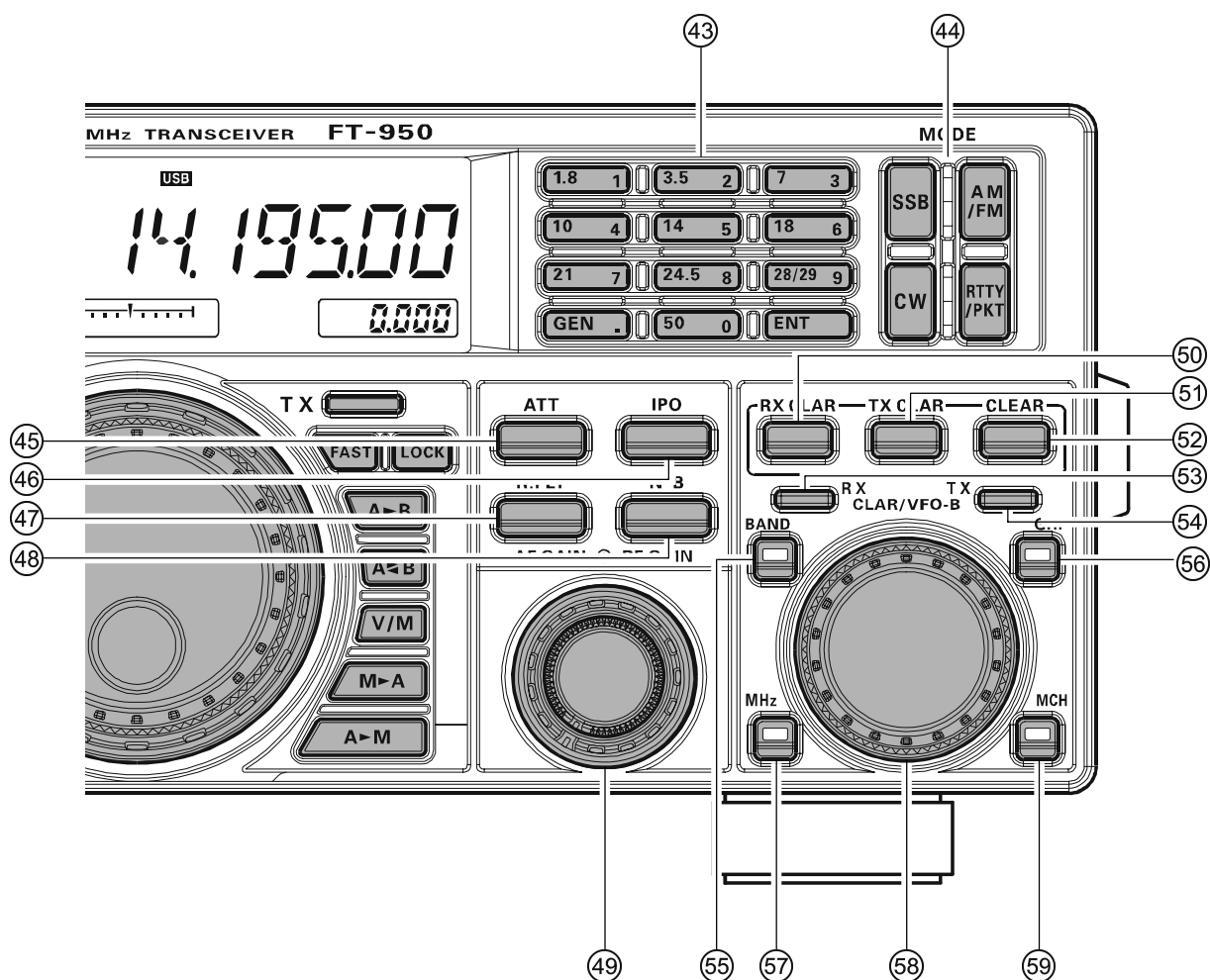

43 [BAND] Keys

These keys allow one-touch selection of the desired Amateur band (1.8 ~ 50 MHz).

The keys may also be used for direct entry of a desired operating frequency during VFO operation.

44 [MODE] Switches

Pressing one of these switches, selects the operating mode, as shown in the chart below. Repeated presses of a particular switch will toggle to the alternate mode, or step through the available selections. For example pressing [SSB] button repeatedly toggles between “LSB” and “USB” mode.

For [RTTY/PKT] operation, press the button briefly to toggle between “RTTY” and “PKT”. Press and hold the button, repeatedly, to step through

“PKT(LSB)” → “PKT(USB)” →

“PKT(FM)” → “PKT(LSB)”

| SWITCH | VARIABLE MODE SELECTIONS |
|------------|---|
| [SSB] | LSB ↔ USB |
| [CW] | CW(LSB) ↔ CW(USB) |
| [AM/FM] | AM ↔ FM |
| [RTTY/PKT] | Momentarily: RTTY(LSB) ↔ PKT(LSB) Press & Hold: RTTY(LSB) ↔ RTTY(USB) or PKT(LSB) → PKT(USB) → PKT(FM) → PKT(LSB) |

45 [ATT] Switch

This button selects the degree of attenuation, if any, to be applied to the receiver input.

Available selections are –6 dB, –12 dB, –18 dB, or OFF. The attenuation level appears in the ATT column of the Block Diagram Display on the display.

ADVICE:

The Attenuator may be used in conjunction with the [IPO] button to provide two stages of signal reduction when an extremely strong signal is being received.

46 [IPO] (INTERCEPT POINT OPTIMIZATION) Switch

This button may be used to set the optimum front end characteristics of the receiver circuit for a very strong signal environment. Available selections are AMP 1 (low distortion amplifier), AMP 2 (2-stage low-distortion RF amplifier), or ON (bypasses the front end RF amplifier), and the selected receiver RF amplifier appears in the IPO column of the Block Diagram Display on the display.

FRONT PANEL CONTROLS & SWITCHES

④7 [R.FLT] (ROOFING FILTER) Switch

This button selects the bandwidth of the receiver first IF Roofing Filter. Available selections are 3 kHz, 6 kHz, 15 kHz, or Auto. The selected bandwidth appears in the FLT column of the Block Diagram Display on the display.

ADVICE:

Because the roofing filter is in the first IF, the protection it provides against interference is quite significant. When set to AUTO, SSB bandwidth is 6 kHz, CW is 3 kHz, FM and RTTY are 15 kHz. On a crowded SSB band, however, you may wish to select the 3 kHz filter, for the maximum possible interference rejection.

④8 [NB] Switch

This button turns the IF Noise Blanker on and off. Press this button momentarily to reduce short-duration pulse noise; the “**NB**” icon will appear in the display. Press and hold this button in for one second to reduce longer-duration man-made pulse noises; the “**NB**” icon will blink for three seconds, then will appear continuously in the display.

Press this button again to disable the noise blanker; the “**NB**” icon will disappear.

④9 [AF GAIN] ↔ [RF GAIN] Knobs

[AF GAIN] Knob

The inner [AF GAIN] knob sets the receiver’s audio volume level. Typically, you will operate with this control set between the 9 o’clock and 10 o’clock positions.

[RF GAIN] Knob

The outer [RF GAIN] knob is the receiver’s RF gain control, which adjusts the gain of the receiver’s RF and IF amplifier stages. This control is normally left in the fully clockwise position.

⑤0 [RX CLAR] Switch

Pressing this button activates the RX Clarifier. This will allow you to temporarily adjust the receiving frequency up to ± 9.999 kHz with the [CLAR/VFO-B] knob. Press this button once more to return the receiver to the original frequency; the Clarifier offset will be remembered, in case you want to use it again. To cancel the Clarifier offset, press the [CLEAR] button.

⑤1 [TX CLAR] Switch

Pressing this button activates the TX Clarifier, to allow offsetting the transmit frequency temporarily. Press this button once more to return the transmitter to the original frequency; the Clarifier offset will be remembered, though, in case you want to use it again. To cancel the Clarifier offset, press the [CLEAR] button.

⑤2 [CLEAR] Switch

Pressing this button clears out any frequency offset you have programmed into the Clarifier register (thereby setting the offset to “Zero”).

⑤3 [(VFO-B)RX] Indicator/Switch

This button switches the receiving frequency to VFO-B, the green LED imbedded within the button will light up. Pressing this button again will return the receiving frequency to VFO-A, and the imbedded green LED will turn off.

⑤4 [(VFO-B)TX] Indicator/Switch

This button transfers control of the transmit frequency/mode to VFO-B, and the red LED in the button will light up. Pressing this button again will transfer frequency/mode control back to the VFO-A side, and the red LED imbedded within this button will turn off.

⑤5 [BAND] Switch

Pressing this button allows you to select the operating band (Amateur bands) by turning the [CLAR/VFO-B] knob.

⑤6 [GRP] Switch

Pressing this button allows you to select the memory group by turning the [CLAR/VFO-B] knob.

⑤7 [MHz] Switch

Pressing this button allows you to tune the VFO frequency down or up in 1 MHz increments, using the [CLAR/VFO-B] knob.

⑤8 [CLAR/VFO-B] Knob

This knob usually tunes the Clarifier offset frequency up to ± 9.999 kHz. Additionally, it is used to adjust the functions selected with five buttons located around the knob.

| FUNCTION SWITCH | EFFECT |
|-----------------|---|
| [(VFO-B)RX] | Rotate the [CLAR/VFO-B] knob to adjust the VFO-B frequency, in the same step as the Main Tuning Dial knob. The Frequency Display will be changed to show the VFO-B frequency. |
| [BAND] | Rotate the [CLAR/VFO-B] knob to change the amateur band selection. |
| [GRP] | Rotate the [CLAR/VFO-B] knob to select the memory group. |
| [MHz] | Rotate the [CLAR/VFO-B] knob to tune the VFO frequency in 1 MHz step. |
| [MCH] | Rotate the [CLAR/VFO-B] knob to select the memory channel. |

⑤9 [MCH] Switch

Pressing this button allows you to select the memory channel using the [CLAR/VFO-B] knob.

DISPLAY INDICATIONS (LEFT SIDE)

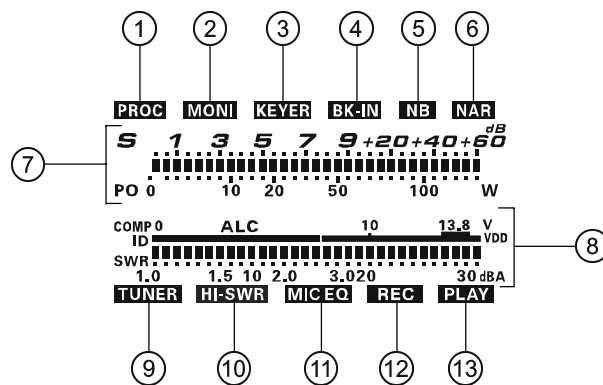

① PROC

This indicator appears whenever the DSP Speech Processor is activated.

② MONI

This indicator appears whenever the transmit monitor circuit is activated.

③ KEYER

This indicator appears whenever the internal CW keyer is activated.

④ BK-IN

This indicator appears whenever CW break-in operation is activated.

⑤ NB

This indicator appears when the receiver's "short-duration" Noise Blanker is activated. This indicator will blink for three seconds, and thereafter appears continuously, when the receiver's "longer pulse" Noise Blanker is activated.

⑥ NAR

This indicator appears whenever the receiver's narrow IF DSP filter is engaged.

⑦ S/PO

On receive, this indicates the received signal strength, from S-0 to S-9+60dB on receiving. On transmit, it indicates the RF Power Output, from 0 to 150 Watts on transmit.

ADVICE:

The S and PO meters can be set to the Peak-hold function via the Menu items "007 DISP PKH S" and "008 DISP PKH PO".

⑧ Multi Function Meter

The five Transmit Multi-Meter functions are listed below.

| | |
|------|--|
| ALC | Indicates the relative ALC voltage. |
| SWR | Indicates the Standing Wave Ratio (Forward: Reflected), from 1.0 to 3.0. |
| ID | Indicates the final amplifier drain current, 0 to 30 ampere. |
| VDD | Indicates the final amplifier drain voltage (nominal value: 13.8 V). |
| COMP | Indicates the speech compressor level, from 0 to 30 dB. |

The function displayed is selected by repeatedly pressing the [METER] switch, to step through the available meter displays. (ALC → SWR → ID → VDD → COMP → ALC ...)

ADVICE:

The ALC and ID meters can be set to the Peak-hold function via the Menu items "009 DISP PKH ALC" and "010 DISP PKH ID".

⑨ TUNER

This indicator appears when the internal Automatic Antenna Tuner is activated.

⑩ HI-SWR

This indicator appears if the directional coupler and microprocessor detect an abnormally high SWR condition (over 3.0:1) that cannot be resolved by the Automatic Antenna Tuner.

NOTE:

If this indicator appears, check to be sure that you have the correct antenna selected for the current operating band. Also check the condition of the antenna, the coaxial cable, and/or the connectors on the cable, to locate and correct the fault.

⑪ MIC EQ

This indicator appears whenever the Three-Band Parametric Microphone Equalizer is activated via the Menu.

⑫ REC

This indicator appears while the optional Voice Memory Unit is recording your voice message, or the Contest Keyer is recording your CW keying.

⑬ PLAY

This indicator appears while the optional Voice Memory Unit is playing back the recorded voice message, or the recorded Contest CW keying.

DISPLAY INDICATIONS (CENTER)

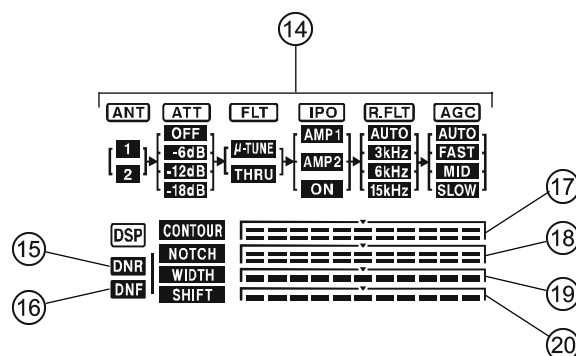

⑭ Block Diagram Display

ANT (1, 2):

Indicates the antenna selected by the front panel [ANT 1-2] button.

ATT (OFF, -6 dB, -12 dB, -18 dB):

Indicates the attenuation level, selected by the front panel [ATT] button.

FLT (μ-TUNE, THRU):

Indicates when the optional μ-TUNE RF filter is selected by the front panel [μ-TUNE] button.

ADVICE:

- When the optional μ-TUNE RF filter is installed, and operated in its frequency range, the “**THRU**” icon will appear.
- When no optional μ-TUNE RF filter is installed, pressing the front panel [μ-TUNE] button will connect the user provided external RF equipment such as a bandpass filter (Not a Yaesu option). When the external path is selected, the “**μ-TUNE**” and “**THRU**” icons will appear. See page 43 for more details.

IPO (AMP 1, AMP 2, ON):

Indicates which front end RF amplifier is selected by the front panel [IPO] button.

R.FLT (AUTO, 3 kHz, 6 kHz, 15 kHz):

Indicates the receiver IF Roofing Filter, which is selected by the front panel [R.FLT] button.

AGC (AUTO, FAST, MID, SLOW):

Indicates the AGC decay time setting, selected by the front panel [AGC] switch.

⑮ DNR

This indicator appears whenever the Digital Noise Reduction feature is activated.

⑯ DNF

This indicator appears whenever the Digital Notch Filter is activated.

⑰ CONTOUR

The peak position of the CONTOUR Filter is graphically depicted here when the CONTOUR Filter is activated.

⑱ NOTCH

The null position of the IF Notch Filter is graphically depicted here when the IF Notch Filter is activated.

⑲ WIDTH

Indicates the bandwidth setting of the DSP IF filter.

⑳ SHIFT

Graphically indicates the peak position of the DSP IF filter.

IMPORTANT NOTE

The **FT-950** uses a Vacuum Fluorescent Display (VFD).

With long-term use, it is normal for the indication color to change and the brightness level to decrease.

The 50 % brightness level is rated more than 30 thousand hours.

DISPLAY INDICATIONS (RIGHT SIDE)

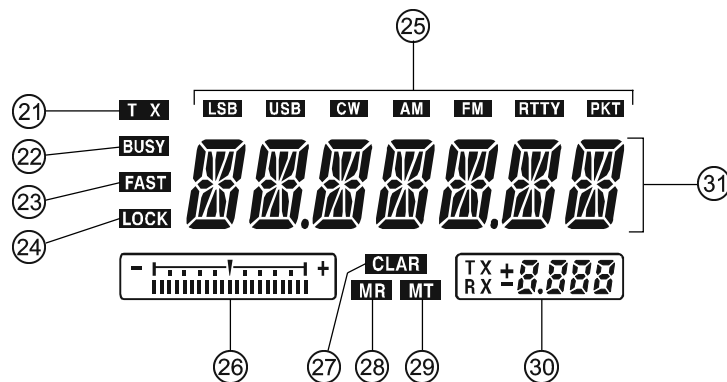

②1 TX

This indicator appears during transmission.

②2 BUSY

This indicator appears whenever the receiver squelch is open. If this indicator is not showing, and reception seems to have been lost on the receiver for no apparent reason, check the position of the [SQL] knob and rotate it fully counter-clockwise to restore reception.

②3 FAST

This indicator appears when the Main Tuning Dial knob's, tuning rate is set to "fast".

②4 LOCK

This indicator appears when the Main Tuning Dial knob is locked.

②5 LSB, USB, CW, AM, FM, RTTY, PKT

Displays the current operating mode.

②6 Tuning Offset Indicator

This is a tuning scale that, as configured from the factory, provides a visual CW tuning indication of the incoming signal's offset from your transceiver's CW carrier frequency, as programmed by the relative clarifier offset, or the peak position of the optional μ -TUNE filter.

②7 CLAR

This indicator appears whenever the Clarifier function is activated.

②8 MR

This indicator appears when the **FT-950** is in the Memory Recall mode.

②9 MT

This indicator appears when the **FT-950** is in the Memory Tune mode to indicate that the memory contents have been temporarily changed.

③0 Multi-Display Window

This window displays either the Clarifier offset or the Memory Channel Number.

ADVICE:

- During FM operation, the Repeater Shift will be indicated in this window. A Negative frequency shift will be indicated by "-" while a Positive frequency shift will be indicated by "+".
- When setting the Menu items, the current setting will appear in this area.
- When setting the CTCSS Tone Squelch Encoding, the current repeater shift direction will appear in this area.
- When controlling the optional rotator, the antenna direction will appear in this area during setup.

③1 Frequency Display

This is the frequency display.

ADVICE:

- When adjusting the keying speed of the internal CW keyer, the keying speed will appear in this area during setup.
- When adjusting the "null" position of the Notch filter, the center frequency of the Notch filter will appear in this area during setup.
- When adjusting the "null" or "peak" position of the Contour filter, the center frequency of the Contour filter will appear in this area during setup.
- When adjusting the microphone gain, the microphone gain level will appear in this area during setup.
- When adjusting the passband of the IF DSP filter, the shift value of the IF SHIFT will appear in this area during setup.
- When adjusting the bandwidth of the IF DSP filter, the bandwidth of the IF passband will appear in this area during setup.
- When setting the Menu items, the Menu item number, Menu group name, and Menu item name will appear in this area during setup.
- When setting the CTCSS frequency for Encoding or Tone Squelch operation, the current tone information will appear in this area during setup.
- When controlling the optional rotator, the current rotation speed will appear in this area during setup.

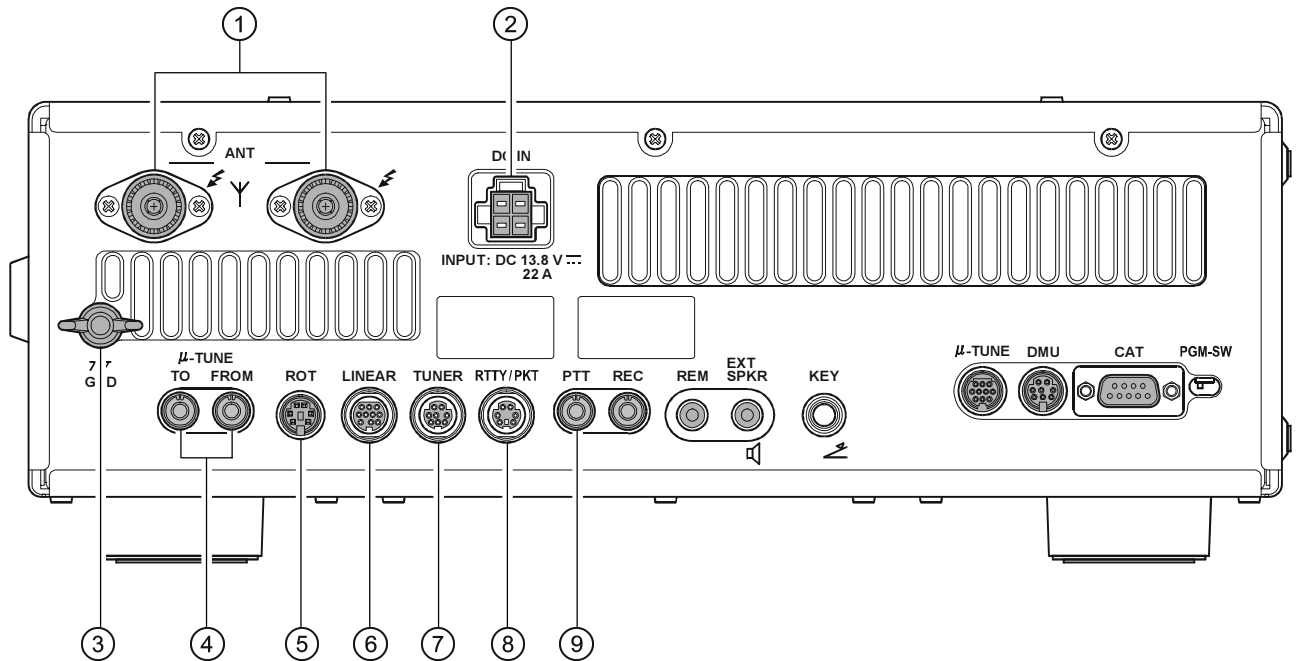

① ANT 1/2 Jacks

Connect your main antenna(s) here, using a type-M (PL-259) connector and coaxial feed lines. The internal antenna tuner affects only the antenna(s) connected here, and only during transmission.

⚠ Warning!

The 100V RF voltage (@100 W/50 Ω) is applied to the TX RF section of the transceiver while transmitting. Do not touch the TX RF section absolutely while transmitting.

② DC IN Jack

This is the DC power supply connection for the transceiver. Use the supplied DC cable to connect directly to a DC power supply, which must be capable of supplying at least 22 A @13.8 VDC.

③ GND

Use this terminal to connect the transceiver to a good earth ground, for safety and optimum performance. Use a large diameter, short braided cable for making ground connections, and please refer to page 9 for other notes about proper grounding.



To prevent the damage from a thunder, atmospheric electricity, electrical shock etc., please take a good earth ground.

④ μ-TUNE Jacks

These jacks are used to connect the optional RF μTuning Kit, signal in and signal out.

⑤ ROT (ROTATOR) Jack

This covered 6-pin MINI-DIN Jack accepts a cable to connect to a YAESU **G-800DXA/-1000DXA/-2800DXA** (for USA/EXP market) or **G-800DXC/-1000DXC/-2800DXC** (for European market) Antenna Rotator (listed models are current as of early 2010). You may control the antenna azimuth, rotation, and rotation speed, using the [BAND] buttons on the front panel.

⑥ LINEAR Jack

This 10-pin output jack provides band selection data, which may be used for control of optional accessories such as the **VL-1000** Solid-state Linear Amplifier. Pinout is shown on page 15.

⑦ TUNER Jack

This 8-pin output jack is used for connection to the **FC-40** External Automatic Antenna Tuner. Pinout is shown on page 15.

⑧ RTTY/PKT Jack

This 6-pin input/output jack accepts AFSK input from a Terminal Node Controller (TNC); it also provides fixed level (100-mV @600 Ohms) receiver audio output, and FSK keying line. Pinout is shown on page 15.

⑨ PTT Jack

This RCA input jack may be used to provide manual transmitter activation using a footswitch or other switching device. Its function is identical to the [MOX] button on the front panel. The same line is available at the **RTTY/PKT** jack for TNC control. Open-circuit voltage is +5 VDC, and closed-circuit current is 1 mA.

REAR PANEL

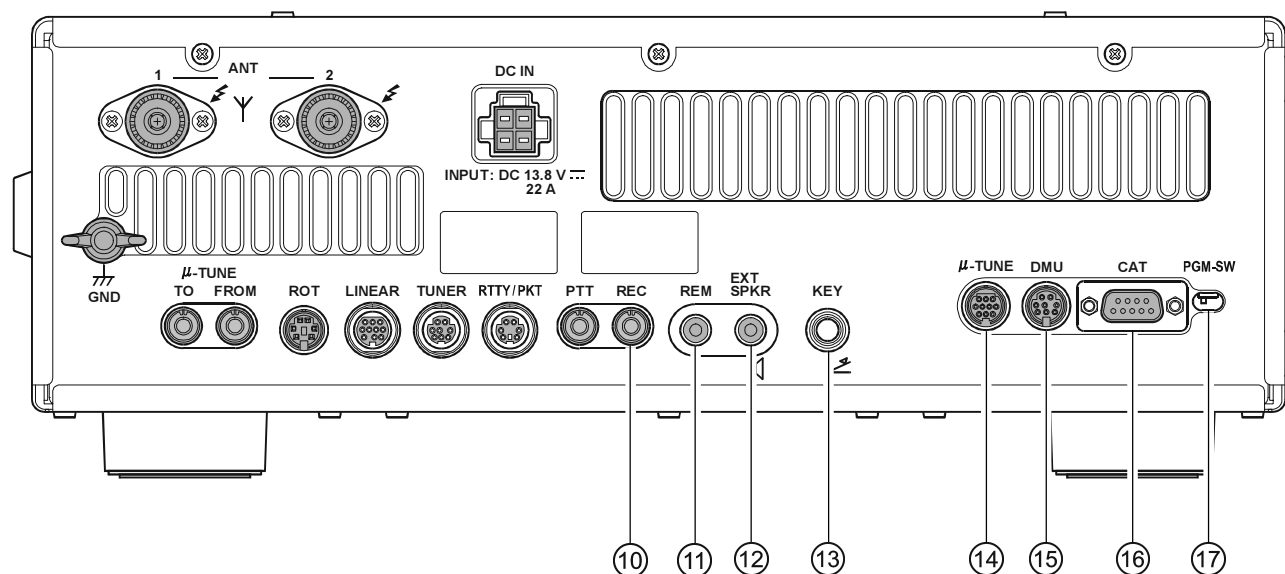

⑩ REC Jack

This RCA jack provides low-level receiver audio output and transmit (monitor) audio output (requires the [MONI] button is turned on), for recording or external amplification. Peak signal level is 30 mVp-p at 10 kOhms.

⑪ REM (REMOTE) Jack

By plugging in the optional **FH-2** Remote Control Keypad to this gold-plated jack, direct access to the **FT-950** CPU is provided for control functions such as contest memory keying, plus frequency and function control.

⑫ EXT SPKR Jack

This 3.5-mm, 2-contact, gold-plated jack provides variable audio output for an external loudspeaker. The audio output impedance at this jack is 4 - 8 Ohms, and the level varies according to the setting of the front panel [AF GAIN] knob. Inserting a plug into this jack disables the internal loudspeaker.

⑬ KEY Jack

This 1/4-inch 3-contact jack accepts a CW key or keyer paddle. A two-contact plug cannot be used in this jack. Key-up voltage is +3.3 V DC, and key-down current is 0.3 mA. Plug wiring is shown on page 15. This jack may be configured for keyer, “Bug”, “straight key”, or computer keying interface operation via Menu item “039 A1A R-TYPE”.

⑭ μ-TUNE Jack

This covered 10-pin mini-DIN jack is used for control of the optional RF μ Tuning Kit.

⑮ DMU Jack

This covered 8-pin mini-DIN jack accepts a cable to connect an optional **DMU-2000** Data Management Unit.

⑯ CAT Jack

This 9-pin serial DB-9 jack allows external computer control of the **FT-950**. Connect a serial cable here and to the RS-232C COM port on your personal computer (no external interface is required).

⑰ PGM-SW Switch

This slide switch is used for updating the transceiver’s firmware. The update software and instructions are available for download from the Vertex Standard website (<http://www.yaesu.com/>).

BASIC OPERATION: RECEIVING ON AMATEUR BANDS

Before turning on main power, please verify the following items once more.

- Have you made all ground connections securely? See page 9 for details.
- Do you have your antenna(s) connected to the rear-panel Antenna jack(s)? See page 10 for details.
- Is your microphone (and/or key or paddle) connected? See page 11 for details.
- If using a linear amplifier, have all interconnections been successfully completed? See page 13 for details.
- Please rotate the [**AF GAIN**] control to the fully counter-clockwise position, to avoid a loud blast of audio when the transceiver turns on. See page 23 for details.

BASIC OPERATION: RECEIVING ON AMATEUR BANDS

Here is the typical start-up procedure for normal operation:

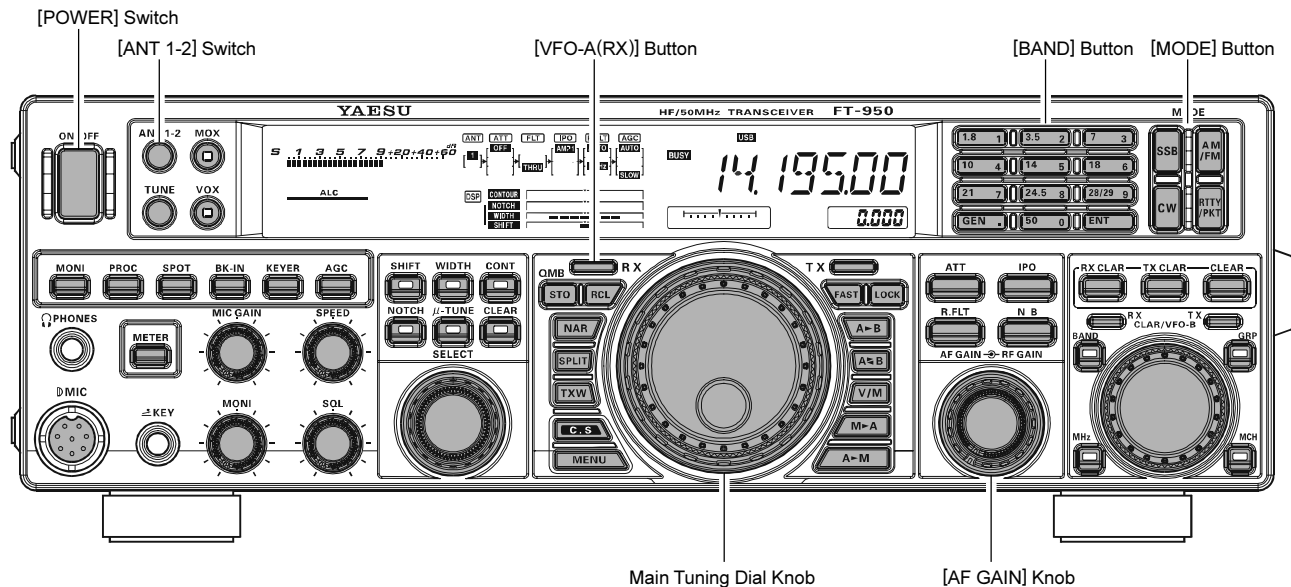

1. Turn on the external DC power supply.
2. Press and hold in the front-panel **[POWER]** switch until the transceiver turns on. After about five seconds (ten seconds if the optional μ -Tuning Kit is connected), the transceiver is ready for full operation.

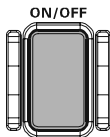

3. The transceiver will start up on 7.000.00 MHz LSB, and normal operation may begin.

NOTE:

To turn power off, press and hold in the front panel **[POWER]** switch for two seconds.

4. Rotate the **[AF GAIN]** knob to set a comfortable audio level on incoming signals or noise. Clockwise rotation of the **[AF GAIN]** knob increases the volume level.

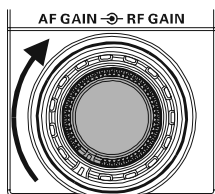

NOTE:

When using headphones, start by rotating the **[AF GAIN]** knob counter-clockwise, then bring the volume level up after you put the headphones on. This will minimize the chance of damage to your hearing caused by an unexpectedly high audio level.

5. Press the **[(VFO-A)RX]** Indicator/Switch to engage the VFO-A; the imbedded LED will glow green.

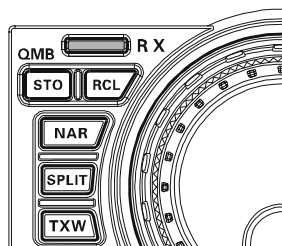

ADVICE:

If you press the **[(VFO-A)RX]** Indicator/Switch when the imbedded LED is already glowing green, the LED will now blink “on” and “off”; this indicates that the VFO-A receiver is temporarily muted. Just press the **[(VFO-A)RX]** Indicator/Switch once more to restore VFO-A receiver operation.

6. Press the **[BAND]** button corresponding to the Amateur band on which you wish to begin operation.

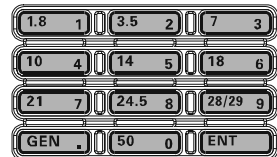

ADVICE:

- One-touch selection of each Amateur band between 1.8 and 50 MHz is provided.
- The **FT-950** utilizes a triple band-stack VFO selection technique, which permits you to store up to three favorite frequencies and modes onto each band’s VFO register. For example, you may store one frequency each on 14 MHz CW, RTTY, and USB, then recall these frequencies by successive, momentary presses of the **[14]** MHz band button. Each Amateur band button may similarly have up to three frequency/mode settings applied.
- When the **[BAND]** button is pressed, the imbedded LED will glow orange, and the **[CLAR/VFO-B]** knob may be used as a band selection knob.
- When the **[MHz]** button (located to the left of the **[CLAR/VFO-B]** knob), is pressed, the imbedded LED will glow orange, and then rotation of the **[CLAR/VFO-B]** knob will change the frequency in 1 MHz steps.

7. Press the **[ANT 1-2]** button to select the appropriate antenna for the band in use. Two TX/RX antennas may be used or one for TX and one RX-only antenna.

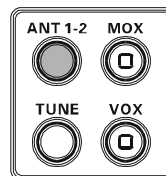

ADVICE:

When you make an antenna selection, that antenna is “remembered” by the microprocessor in conjunction with the VFO register in use.

BASIC OPERATION: RECEIVING ON AMATEUR BANDS

8. Press the appropriate [MODE] button to select the desired operating mode.

Pressing the [SSB] button toggles the LSB and USB mode, and also pressing the [AM/FM] button toggles the AM and FM mode.

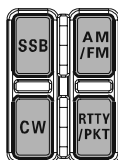

ADVICE:

- By convention in the Amateur bands, LSB is used on the 7 MHz and lower bands (with the exception of 60 meters), while USB is utilized on the 14 MHz and higher bands.
- When changing modes from SSB to CW, you will observe a frequency shift on the display. This shift represents the BFO offset between the “zero beat” frequency and the audible CW pitch (tone) you can hear (the pitch is programmed via the Menu item “045 A1A PITCH”), even though the actual tone that you hear is not changing. If you do not want this frequency shift to appear when changing modes from (for example) USB to CW, use the Menu item “047 A1A FRQDISP”, described on page 112.
- When operating on the FM mode, rotate the [SQL] (Squelch) knob clockwise to the point where the background noise is just silenced. This is the point of maximum sensitivity to weak signals. Excessive advancement of the [SQL] knob will degrade the ability of the receiver to detect weak signals.

9. Rotate the Main Tuning Dial knob to tune around the band, and begin normal operation.

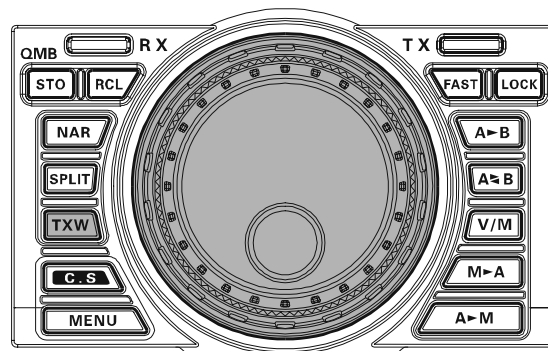

ADVICE:

- Clockwise rotation of the Main Tuning Dial knob increases the operating frequency, one “step” of the synthesizer at a time; similarly, counter-clockwise rotation of the Main Tuning Dial knob will decrease the frequency. Two settings, one “normal” and one “fast”, are available on each operating mode. Pressing the [FAST] button engages the “Fast” tuning selection, see chart below.
- It is possible to set the frequency change over one dial rotation, separately for the CW mode, using the Menu items “084 TUN DIALSTP” and “085 TUN CW FINE”. See page 116.
- If you want to navigate rapidly, so as to effect rapid frequency change, there are several techniques available:
 - Direct keyboard entry of the frequency (see page 39).
 - Use the [CLAR/VFO-B] knob to tune in 1 MHz steps (see page 39).
 - Use the microphone’s [UP]/[DWN] scanning keys, if your microphone is so equipped (see page 39).

MAIN TUNING DIAL KNOB TUNING RATE

| OPERATING MODE | 1 STEP | 1 DIAL ROTATION |
|-----------------------------|-------------------|---------------------|
| | NORMAL [FAST] | NORMAL [FAST] |
| LSB/USB/CW/AM/RTTY/PKT(LSB) | 10 Hz [100 Hz] | 10 kHz [100 kHz] |
| FM/PKT(FM) | 100 Hz [1 kHz] | 100 kHz [1 MHz] |

[] : [FAST] switch set to “ON”

BASIC OPERATION: RECEIVING ON AMATEUR BANDS

OPERATION ON 60-METER (5 MHz) BAND (U.S. AND U.K. VERSION ONLY)

The recently-released 60-meter band is covered, in the **FT-950**, by fixed memory channels. These channels are set to USB, and they appear between the “last” PMS channel (“P9U”) and the first “regular” memory channel (Channel 1):

1. Press the **[V/M]** button once to enter the “Memory” mode; the “**MR**” icon will appear in the display and a memory channel number will appear on the Multi-Display Window in the display.

ADVICE:

If you can not enter the “Memory” mode, check to see if the transceiver is in VFO-B mode (the green **[(VFO-B)RX]** Indicator/Switch is illuminated). If so, press the **[(VFO-A)RX]** Indicator/Switch to return operation to VFO-A. Now, press the **[V/M]** button to enter the “Memory” mode.

2. Press the **[MCH]** button located on the bottom right of the **[CLAR/VFO-B]** knob. The LED imbedded in the button will glow orange to signify that rotation of the **[CLAR/VFO-B]** knob will allow selection of the memory channel.
3. Memory channels (“US1” through “US5”: U.S. version or “US1” through “US7”: U.K. version) are pre-programmed, at the factory, with the permitted frequencies in the 5 MHz band, and the USB mode is automatically selected on these channels.
4. To exit from 60-meter operation and return to the VFO mode, just press the **[V/M]** button.

NOTE:

The frequencies and operating mode for 5 MHz band operation are fixed, and may not be changed.

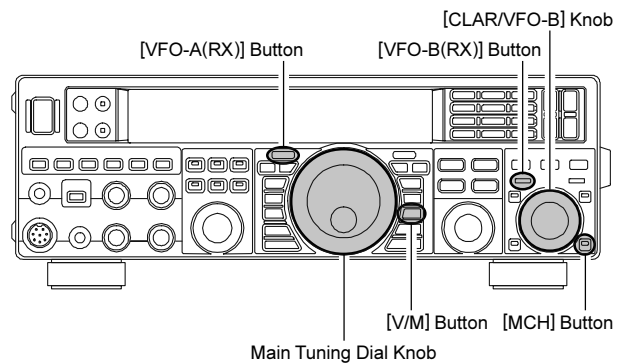

| CHANNEL NUMBER | FREQUENCY | |
|----------------|--------------|--------------|
| | U.S. VERSION | U.K. VERSION |
| US1 | 5.332000 MHz | 5.260000 MHz |
| US2 | 5.348000 MHz | 5.280000 MHz |
| US3 | 5.368000 MHz | 5.290000 MHz |
| US4 | 5.373000 MHz | 5.368000 MHz |
| US5 | 5.405000 MHz | 5.373000 MHz |
| US6 | — | 5.400000 MHz |
| US7 | — | 5.405000 MHz |

CLAR (CLARIFIER) OPERATION

The [TX CLAR], [RX CLAR], [CLEAR] buttons and [CLAR/VFO-B] knob are used to offset the receive frequency, the transmit frequency, or both, from their settings on the VFO-A frequency. Four small numbers on the Multi-Display Window show the current Clarifier offset. The Clarifier controls on the **FT-950** are designed to allow you to preset an offset (up to ± 9.999 kHz) without actually retuning, and then to activate it via the Clarifier's [RX CLAR] and [TX CLAR] buttons. This feature is ideal for following a drifting station, or for setting small frequency offsets sometimes utilized in DX "Split" work.

Here is the technique for utilizing the Clarifier:

1. Press the [RX CLAR] button. In the Multi-Display Window, the "RX" notation will appear, and the programmed offset will be applied to the receive frequency. 
2. Rotation of the [CLAR/VFO-B] knob will allow you to modify your initial offset on the fly. Offsets of up to ± 9.99 kHz may be set using the Clarifier.

To cancel Clarifier operation, press the [RX CLAR] button. The "RX" notation will disappear from the display.

ADVICE:

- Turning the Clarifier off simply cancels the application of the programmed offset from the receive and/or the transmit frequencies. To clear the Clarifier offset, and reset it to "zero," press the [CLEAR] button. The programmed offset is displayed in the small multi-channel window of the frequency display. 
- You may also activate the clarifier on the VFO-B frequency. In this case, the offset frequency is set using the Main Tuning Dial knob, instead of the [CLAR/VFO-B] knob (VFO-B operation is discussed on page 35).
- The Clarifier operation (including the offset frequency) will be memorized independently on each VFO stack of VFO-A and VFO-B.

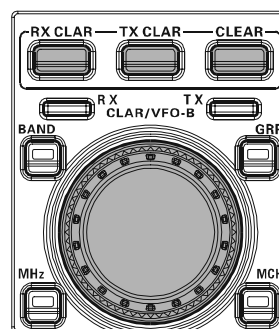
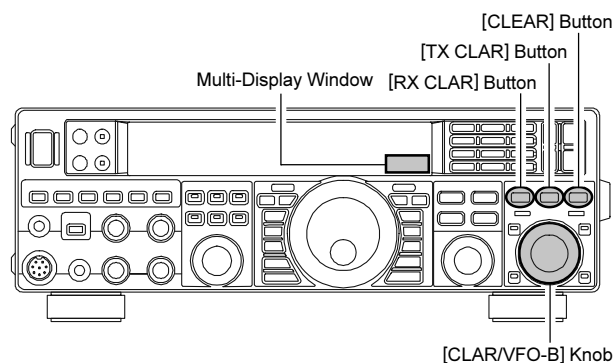

TXCLAR

Alternately, You may apply the Clarifier offset to the transmit frequency, without changing the receive frequency (typically, for "split" DX pile-ups). See page 68 for details.

The Tuning Offset Indicator provides a graphical representation of the Clarifier offset.

In the factory default setting On CW, the Tuning Offset Indicator is used for CW Center Tuning, instead of Clarifier Offset. If you wish to change this so that the Clarifier Offset is also displayed on CW, use the following procedure:

1. Press the [MENU] button to enter the Menu mode.
2. Rotate the [SELECT] knob to select Menu item "006 DISP BAR SEL".

ADVICE:

Press the [SELECT] knob momentarily to toggle the Menu item display between "006 DISP" and "BAR SEL".

3. Rotate the [CLAR/VFO-B] knob to select "CLAR (Clarifier)" (replacing the default "C-tn (CW TUNING)" selection).
4. Press and hold in the [MENU] button for one second to save the new setting and exit to normal operation.

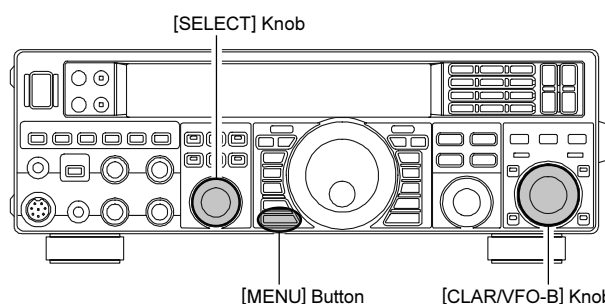
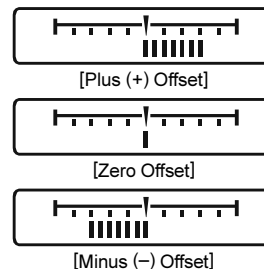

BASIC OPERATION: RECEIVING ON AMATEUR BANDS

LOCK

You may lock the setting of the Main Tuning Dial knob (for VFO-A frequency tuning) and the [CLAR/VFO-B] knob (for VFO-B frequency tuning), to prevent accidental frequency change.

Main Tuning Dial knob Lock

To lock the Main Tuning Dial knob, press the [(VFO-A)RX] Indicator/Switch to illuminate the imbedded green LED, then press the [LOCK] button that is located to the right of the Main Tuning Dial knob. To unlock the Dial setting, and restore normal tuning, press the [LOCK] button once more.

[CLAR/VFO-B] knob Lock

To lock the [CLAR/VFO-B] knob, press the [(VFO-B)RX] Indicator/Switch to illuminate the imbedded green LED, then press the [LOCK] button that is located to the right of the Main Tuning Dial knob. To unlock the [CLAR/VFO-B] knob, and restore normal tuning, press the [LOCK] button once more.

ADVICE:

The lock feature will be memorized independently on each Main Tuning Dial knob and the [CLAR/VFO-B] knob.

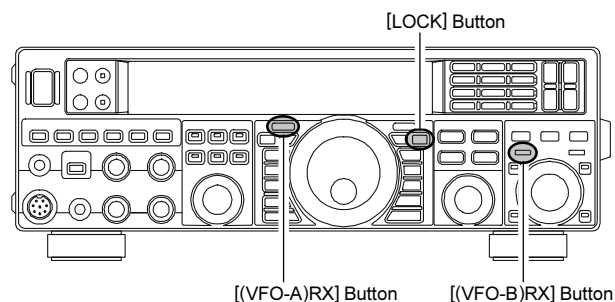

DIMMER

The illumination level of the display may be adjusted via Menu item “005 DISP DIM VFD”.

To adjust the illumination level:

1. Press the [MENU] button to enter the Menu mode.
2. Rotate the [SELECT] knob to select Menu item “005 DISP DIM VFD”.

ADVICE:

Press the [SELECT] knob momentarily to toggle the Menu item display between “005 DISP” and “DIM VFD”.

3. Rotate the [CLAR/VFO-B] knob to select the desired illumination level.
4. Press and hold in the [MENU] button for one second to save the new setting and exit to normal operation.

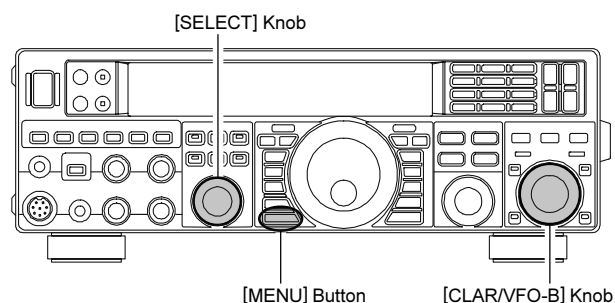

USING THE VFO-B

VFO-B operates similar to VFO-A, which you should be familiar with by now. However, the [CLAR/VFO-B] knob, instead of the Main Tuning Dial knob selects the frequency for VFO-B (See box below for tuning rate). The two VFOs make simple transmit/receive split frequency operation possible. Use various combinations of the four VFO red and green transmit and receive switches to set up split frequency operation. The [SPLIT] button also sets up split frequency operation. See page 69 for details about Split-Frequency Operation

The frequency and mode data can be transferred from VFO-A to VFO-B by pressing the [A▶B] button, don't forget that this will overwrite any settings that were in VFO-B previously. Also, the contents of the two VFOs can be swapped (with no loss of data) by pressing the [A◀B] button.

Most of the interference reduction features, which are described later, can also be used on VFO-B.

Two things you cannot do with VFO-B that you can do with VFO-A, are store the contents of VFO-B directly into a memory, and set the Clarifier offset. For these functions you need to swap the VFO-B with the VFO-A by pressing the [A◀B] button, then store the contents into the memory or set the Clarifier.

[CLAR/VFO-B] KNOB TUNING RATE

| OPERATING MODE | 1 STEP | 1 DIAL ROTATION |
|-----------------------------|-------------------|-------------------|
| | NORMAL [FAST] | NORMAL [FAST] |
| LSB/USB/CW/AM/RTTY/PKT(LSB) | 10 Hz [100 Hz] | 2 kHz [20 kHz] |
| FM/PKT(FM) | 100 Hz [1 kHz] | 20 kHz [200 kHz] |

[] : [FAST] switch set to "ON"

ADVICE:

It is possible to set the frequency change over one dial rotation, separately for the CW mode, using the Menu items "084 TUN DIALSTP" and "085 TUN CW FINE". See page 116.

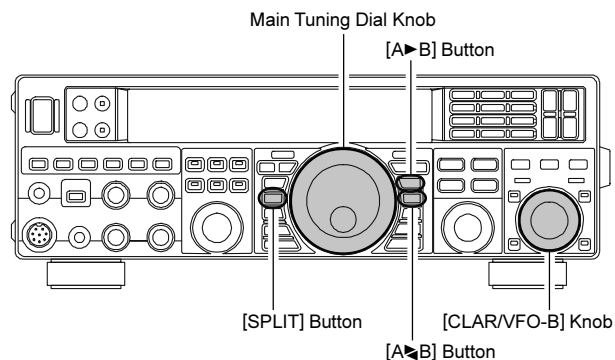

CONVENIENCE FEATURES

“MY BANDS” OPERATION

When operating on an Amateur Band, it is possible to use the [BAND] button to engage the [CLAR/VFO-B] knob for Amateur band selection. The “My Bands” feature allows you to skip some Amateur bands, and make *only* your preferred bands available for selection via the [CLAR/VFO-B] knob.

This feature can be *very* useful in a contest, where the 10/18/24 MHz bands are not used, or if you do not have antennas for some bands.

“My Bands” Setup

1. Press the [MENU] button to engage the Menu mode.
2. Rotate the [SELECT] knob to select Menu item “090 TUN MY BAND”.

ADVICE:

Press the [SELECT] knob to toggle the Menu item display between “090 TUN” and “MY BAND”.

3. Rotate the [CLAR/VFO-B] knob to choose a band that you wish to omit (*skip*) from the band selection loop (when using the [CLAR/VFO-B] knob for band selection). The available choices are 1.8/3.5/5/7/10/14/18/21/24/28/50/GE (General Band).
4. Press the [ENT] button to set the command to ON. The “E” (Enable) notation at the right of the band notation will change to “d” (disable).
5. Repeat steps 3 and 4 to select/deselect as many bands as you like.

NOTE:

The “ON” command sets the selected band to be *skipped*. The “OFF” command sets the selected band to be *included* in the band selection list. Change the “d” notation to “E” to restore a previously deleted band to the band selection list.

6. Press and hold in the [MENU] button for one second to lock in the new configuration and exit to normal operation.

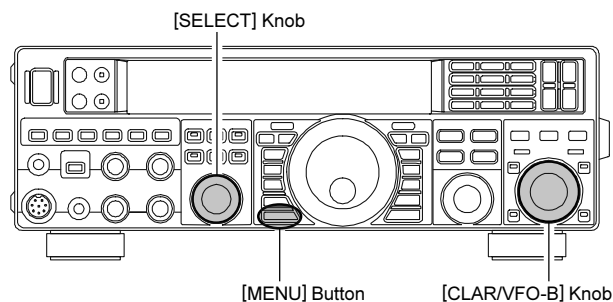

ADVICE:

The “My Band” feature affects both the VFO-A and VFO-B.

“My Band” Operation

1. Press the [BAND] button at the left of the [CLAR/VFO-B] knob; the imbedded LED will glow orange.
2. Rotate the [CLAR/VFO-B] knob to choose the Amateur band on which you wish to operate. Only those Amateur bands that have *not* been set to “skip” will appear as you scroll through the bands.

To disable the “My Band” Operation, press the [BAND] button again; the imbedded orange LED goes out.

ADVICE:

The “My Band” feature affects both the VFO-A and VFO-B.

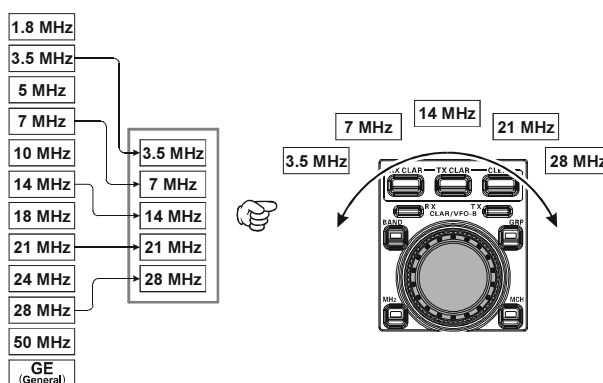
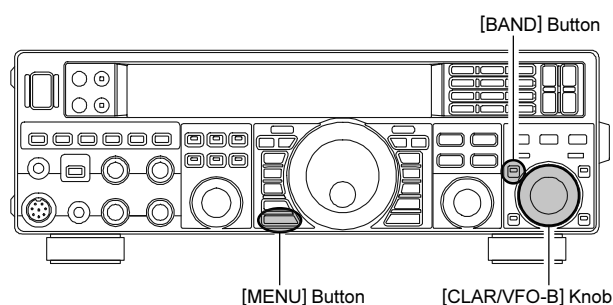

BAND STACK OPERATION

The **FT-950** utilizes a triple band-stack VFO selection technique, that permits you to store up to three favorite frequencies and modes onto each band's VFO register. For example, you may store one frequency each on 14 MHz CW, RTTY, and USB, then recall these VFOs by successive, momentary presses of the **[14]** MHz band button. Each Amateur band key may similarly have up to three frequency/mode settings applied. Both the VFO-A and VFO-B systems have their own, independent, band stacks.

A typical setup, for the 14 MHz band, might be arranged like this:

1. Program 14.025 MHz, CW Mode, then press the **[14]** MHz band button;
2. Program 14.080 MHz, RTTY Mode, then press the **[14]** MHz band button;
3. Program 14.195 MHz, SSB Mode, then press the **[14]** MHz band button.

With this configuration, successive momentary presses of the **[14]** MHz band button will allow you to step sequentially through these three VFOs.

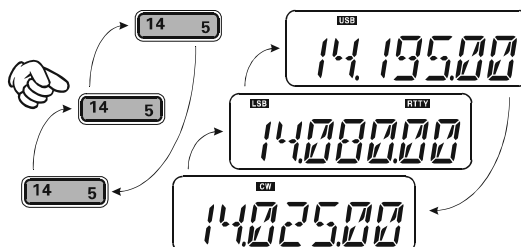
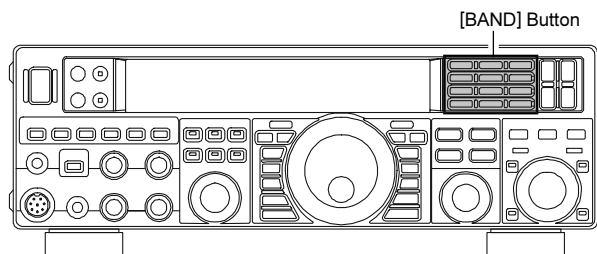

C.S (CUSTOM SWITCH)

The front panel **[C.S]** button may be programmed to directly access an often-used Menu Mode selection.

C.S Setup

1. Press the **[MENU]** button to engage the Menu mode; the Menu list will appear on the display.
2. Rotate the **[SELECT]** knob to select the Menu item you want to access with the front panel **[C.S]** button.

ADVICE:

Press the **[SELECT]** knob to toggle the Menu item display between "Menu item number and group" and "Menu Function".

3. Press and hold in the **[C.S]** button for two seconds to lock in your selection.
4. Press and hold in the **[MENU]** button for one second to save the new configuration and exit to normal operation.

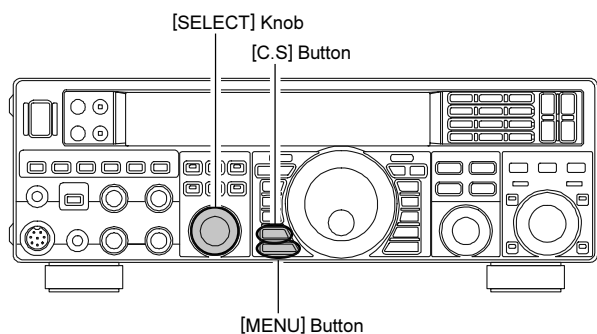

Menu Selection Recall via [C.S] button

Press the **[C.S]** button.

The programmed Menu item will appear on the display. You may now rotate the **[CLAR/VFO-B]** knob to change the setting of this menu item. Press and hold the **[MENU]** button for one second, when you are done, to save the new configuration and exit to normal operation.

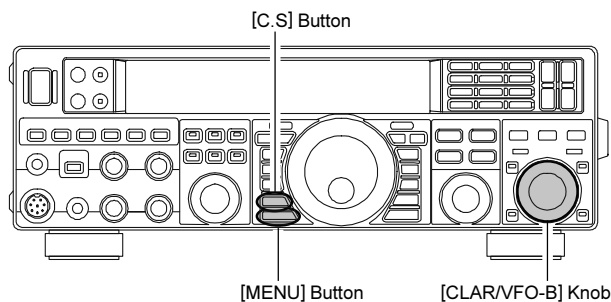

CONVENIENCE FEATURES

ROTATOR CONTROL FUNCTIONS

When using a YAESU model **G-800DXA**, **G-1000DXA**, **G-2800DXA** (for USA/EXP market) or **G-800DXC**, **G-1000DXC**, **G-2800DXC** (for European market) Antenna Rotator (not supplied), it is possible to control it from the front panel of the **FT-950**.

1. Press and hold in the **[ENT]** button (one of the **[BAND]** key switches) for one second. The Frequency Display area will change over to the “Rotator Control” configuration.
2. Press either the **[3.5(2)]** button or the **[7(3)]** button to rotate the antenna. Pressing the **[3.5(2)]** button will cause rotation to the left (counter-clockwise) by two degree steps, while pressing the **[7(3)]** button will cause rotation to the right (clockwise) by two degree steps.
3. Press the **[14(5)]** button or the **[18(6)]** button to control the speed of rotation. Pressing the **[14(5)]** button will cause slower rotation, while pressing the **[18(6)]** button will speed up rotation. Usually, you will be using the “100%” speed setting.

When you are through exercising rotator control, press the **[ENT]** button momentarily. The Frequency Display will return to the main display field.

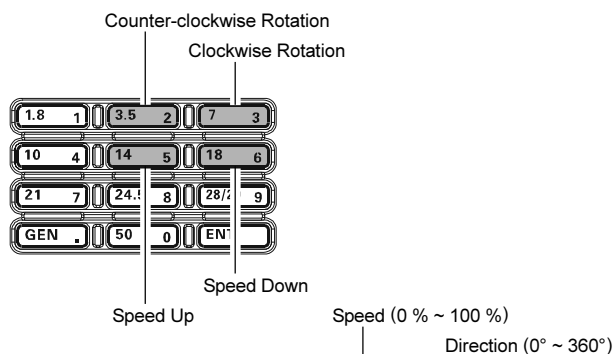
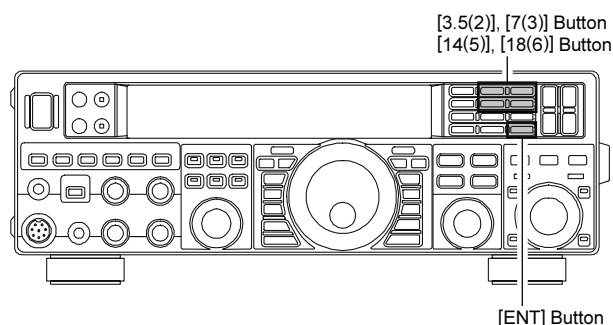

IMPORTANT NOTE

- ❑ Set the starting point to match your rotator control indicator needle via the Menu item “011 DISP RTR STU”. The default setting is zero (north). If your controller starting point is south, the Menu item “011 DISP RTR STU” must be set to “180”. If not set properly the **FT-950** display will not show the correct direction.
- ❑ When the rotator control indicator needle does not indicate the precise antenna direction, calibrate the indicator needle precisely to the antenna direction via the Menu item “012 DISP RTR ADJ”.

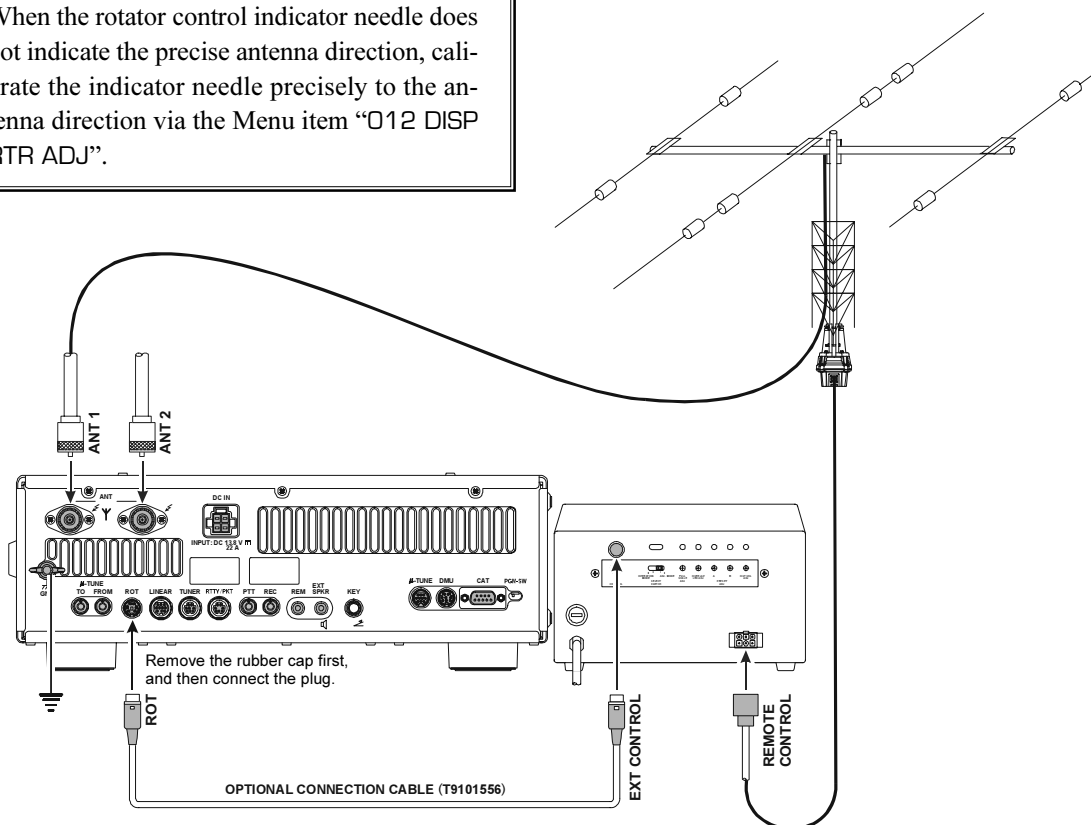

MORE FREQUENCY NAVIGATION TECHNIQUES

Keyboard Frequency Entry

You may enter operating frequencies directly into the current VFO, using the front panel [BAND] key buttons.

Example: Enter 14.250.00 MHz

1. Press the [ENT] button to engage the direct frequency entry process. Now, beginning with the first digit of the frequency (the leftmost digit), we will enter the required digits of the frequency.
2. Press, in order, the digits of the operating frequency, using the [BAND] buttons (the frequency entry digit or decimal point is printed on the right side of the buttons). In this example, enter [1.8(1)] → [10(4)] → [GEN(.)] → [3.5(2)] → [14(5)] → [50(0)] → [50(0)] → [50(0)] → [50(0)]. The decimal point after the “MHz” portion of the frequency must be entered, but no decimal point is required after the “kHz” portion.
3. Press the [ENT] button once more. A short “beep” will confirm that the frequency entry was successful, and the new operating frequency will appear on the display.

ADVICE:

If you attempt to enter a frequency outside the operating range of 30 kHz ~ 56 MHz, the microprocessor will ignore the attempt, and you will be returned to your previous operating frequency. If this happens, please try again, taking care not to repeat the error in the frequency entry process.

Using the [CLAR/VFO-B] knob

You may change the current VFO frequency in 1 MHz steps. Press the [MHz] button located at the bottom and left of the [CLAR/VFO-B] knob. The 1 MHz steps will be applied to the current VFO frequency. The imbedded LED in the [MHz] button will glow orange in the latter case.

When tuning in 1 MHz steps, clockwise rotation of the [CLAR/VFO-B] knob will increase the frequency, while counter-clockwise rotation will decrease the frequency.

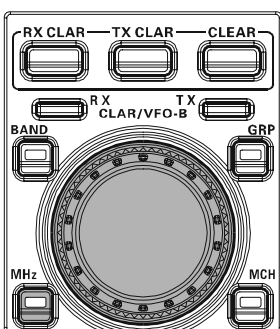
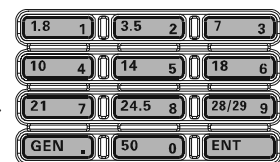

Using the [UP]/[DWN] buttons of the supplied MH-31B8 Hand Microphone

The [UP]/[DWN] buttons on the supplied MH-31B8 Hand Microphone may also be used to manually scan the frequency upward or downward.

The microphone's [UP]/[DWN] buttons utilize the tuning steps of the Main Tuning Dial knob. When the microphone's [FST] button is pressed, the tuning rate increases by a factor of ten, in a manner similar to the transceiver front panel [FST] button.

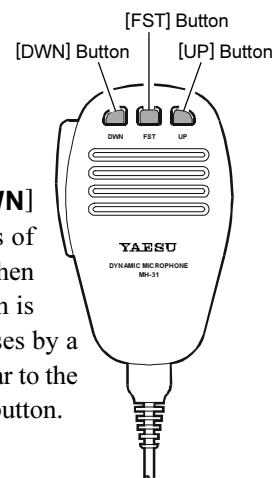

ADVICE:

You may independently set the tuning steps of the [UP]/[DWN] buttons in the AM and FM modes. To set new tuning steps, use Menu items “087 TUN AM STEP” and “088 TUN FM STEP”.

INTERFERENCE REJECTION

RECEIVER OPERATION (FRONT END BLOCK DIAGRAM)

The **FT-950** includes a wide range of special features to suppress the many types of interference that may be encountered on the HF bands. However, real world interference conditions are constantly changing, so optimum setting of the controls is somewhat of an art, requiring familiarity with the types of interference and the subtle effects of some of the controls. Therefore, the following information is provided as a general guideline for typical situations, and a starting point for your own experimentation.

The **FT-950**'s interference-fighting circuitry begins in its "RF" stages, and continues throughout the entire receiver section. **FT-950** allows configuration of the features described below.

R. FLT (IF Roofing Filters) (SEE PAGE 45)

Three Roofing filters, of 15 kHz, 6 kHz, and 3 kHz bandwidths, are provided in the 69 MHz First IF, right after the first mixer. These filters are automatically selected to provide narrow-band selectivity to protect the following IF and DSP stages. The automatically selected filter, may be manually changed by the operator, if desired, for special operating circumstances.

CONTOUR Filter (SEE PAGE 47)

The DSP Contour filter has the unique ability to provide either a null or a peak in tunable segments of the receiver passband. You may suppress interference and excessive frequency components on an incoming signal, or you may peak those tunable frequency segments. The level of the null or peak, and the bandwidth, over which it is applied, are adjustable via the Menu.

IF SHIFT (SEE PAGE 48)

The passband center frequency of the IF DSP filter may be moved up or down by adjusting this control.

IF WIDTH (SEE PAGE 49)

The width of the IF DSP filtering may be adjusted using this control.

IF NOTCH (SEE PAGE 51)

The IF Notch filter is a high-Q notch filter that can significantly reduce, if not eliminate, an interfering carrier.

DNF (Digital Notch filter) (SEE PAGE 52)

When multiple interfering carriers are encountered during reception, the Digital Notch Filter can significantly reduce the level of these signals.

DNR (Digital Noise Reduction) (SEE PAGE 52)

The DSP's Digital Noise Reduction (DNR) feature utilizes 15 different mathematical algorithms to analyze and suppress different noise profiles encountered on the HF/50 MHz bands. Choose the selection that provides the best noise suppression, and allows the signal to rise up out of the noise.

AGC (SEE PAGE 55)

The AGC system is highly adaptable to changing signal and fading characteristics, making reception possible under the most difficult conditions.

INTERFERENCE REJECTION

ATT

When extremely strong local signals or high noise, still degrades reception, you can use the [ATT] button to insert 6, 12, or 18-dB of RF attenuation in front of the RF amplifier.

1. Press the [ATT] button several times to set the desired attenuation level, per the chart below.

OFF : Attenuator is Off

-6dB : The incoming signal power is reduced by 6 dB (Signal voltage reduced by 1/2)

-12dB : The incoming signal power is reduced by 12 dB (Signal voltage reduced to 1/4)

-18dB : The incoming signal power is reduced by 18 dB (Signal voltage reduced to 1/8th)

The selected attenuation level will be indicated in the ATT column of the Block Diagram Display on the display.

2. To restore full signal strength through the Attenuator circuit area, press the [ATT] button to restore the ATT display to the “OFF” position.

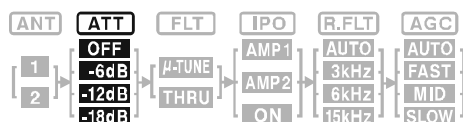

BLOCK DIAGRAM DISPLAY

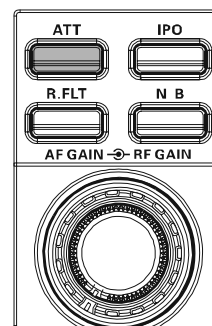
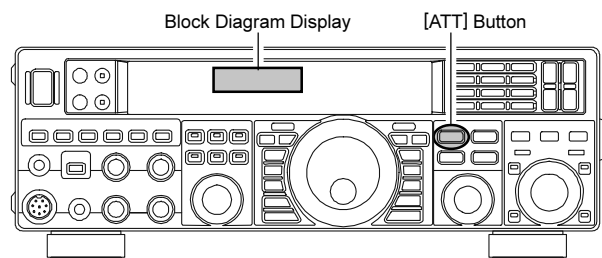

ADVICE:

- The attenuator selection will be memorized independently on each VFO stack of the VFO-A and VFO-B.
- If background noise causes the S-meter to deflect on clear frequencies, press the [ATT] button until the S-meter drops to about “S-1”. This setting optimizes the trade-offs between sensitivity, noise, and interference immunity. Also, once you have tuned in a station you want to work, you may want to reduce sensitivity further (add more attenuation) by pressing the [ATT] button to a higher setting. This reduces the strength of all signals (and noise) and can make reception more comfortable, important especially during long QSOs. When looking for weak signals on a quiet band, you will want maximum sensitivity, so the IPO should be disabled and the [ATT] button should be set to “OFF.” This situation is typical during quiet times on frequencies above 21 MHz, and when using a small or negative-gain receiving antenna on other bands.

INTERFERENCE REJECTION

μ-TUNE FILTER (REQUIRES THE OPTIONAL RF μTUNING KIT)

The RF μTuning Kit provides ultra-sharp RF selectivity for the front end of the transceiver. Very high Q is made possible by the narrow-band design. Three RF μTuning Kits are available. The **MTU-160** covers the 1.8 MHz band. The **MTU-80/40** covers the 3.5 and 7 MHz bands. The **MTU-30/20** covers 10.1 and 14 MHz bands.

When any (or all) of the three optional units are connected, they will be automatically adjusted to center on your operating frequency.

The narrow bandwidth is especially useful on the low bands, when many strong signals are being received via NVIS propagation (Near Vertical-Incidence Signals) within a narrow bandwidth. The added protection for the RF stage is especially helpful in preventing IMD and blocking.

μ-Tune Operation

1. Press the **[μ-TUNE]** button to activate the μ-Tune filter. The LED inside the **[μ-TUNE]** button glows orange. The **[SELECT]** knob works as the μ-TUNING knob.

ADVICE:

- ❑ The tuning position of the μ-Tune filter will appear in the Tuning Offset Indicator on the display for three seconds, and the “**μ-TUNE**” icon will be indicated in the FLT column of the Block Diagram Display on the display.

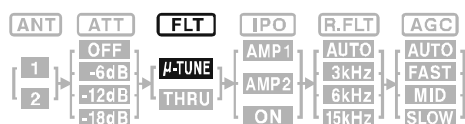

BLOCK DIAGRAM DISPLAY

- ❑ The μ-Tune circuit will automatically align itself onto your operating frequency.
 - ❑ Remember that μ-Tune only operates on the 14 MHz and lower bands.
2. Rotate the **[SELECT]** knob to peak the response (background noise) or reduce interference.

ADVICE:

- ❑ You may observe the relative peak point of the μ-Tune filter in the Tuning Offset Indicator on the display, while tuning the **[SELECT]** knob.
 - ❑ The amount of change in the center frequency of the μ-Tune filter, when rotating the **[SELECT]** knob by one click, can be configured using Menu item “032 GENE μT DIAL”.
 - ❑ If you have performed manual adjustment of the μ-Tune filter center frequency, you may press the **[CLEAR]** button to re-center the filter response on your current operating frequency.
3. Press the **[μ-TUNE]** button (or **[SELECT]** knob) momentarily to disengage the μ-Tune filter; the “**μ-TUNE**” icon will be changed to “**THRU**” in the FLT column of the Block Diagram Display on the display. In this mode, only the fixed bandpass filter for the current band will be engaged.

ADVICE:

Alternate presses of the **[μ-TUNE]** button or the **[SELECT]** knob, will switch the μ-Tune filter between on or off.

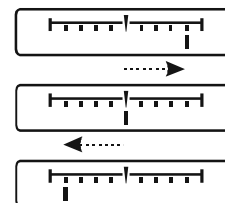
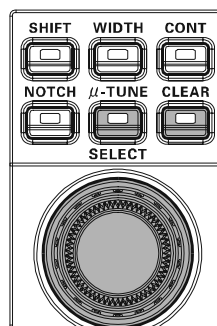
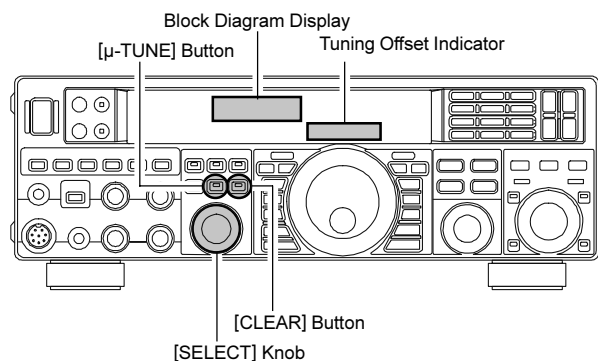

TUNING OFFSET INDICATOR

ADVICE:

- ❑ The μ-Tune Filter selection will be memorized independently on each VFO stack of the VFO-A and VFO-B.
- ❑ You may change the indication of the Tuning Offset Indicator to display the center frequency of the μ-Tune filter continuously while the μ-Tune filter is activated. This is Menu item “006 DISP BARSEL”. See Box on the next page for details of the setting.

QUICK NOTE:

The permeability-tuning concept utilized in the μ-Tune circuit dates back many decades, as it was incorporated in such classic transceivers as the **FT-101**, the **FT-901** series, the **FTdx400**, and similar models. The μ-Tuning Kit uses the same circuit as our flag ship model the **FTdx9000**, which is the highest development of this circuit concept ever employed in an Amateur transceiver.

INTERFERENCE REJECTION

μ-TUNE FILTER (REQUIRES THE OPTIONAL RF μTUNING KIT)

ADVICE:

- The μ-Tune filters are the most advanced, selective RF preselector filters ever incorporated into an Amateur Radio transceiver. The RF selectivity provided by μ-Tune can be of tremendous value in ensuring quiet, intermod-free reception even in the most crowded bands on a contest weekend. The μ-Tune filters provide RF selectivity on the order of a few dozen kHz at -6 dB, at the expense of a few dB of system gain on bands where noise figure is seldom an issue. You will notice that the S-meter deflection, when μ-Tune is engaged, is slightly less than when it is out of the circuit; this is normal. If your antenna system gain is so low that you cannot hear the band noise when μ-Tune is engaged (highly unlikely), just switch it out, to eliminate the slight insertion loss.
- As you tune around on an amateur band with μ-Tune engaged, the microprocessor automatically commands the stepper motor driving the toroid core stack to center the filter on your current operating frequency. You may, however, use the [SELECT(μ-TUNE)] knob to skew the filter response to one side or the other from your operating frequency, to deal with heavy interference on one side. To re-center the μ-Tune filter on your operating frequency, and eliminate any offset, press the [CLEAR] button.

Changing the Tuning Offset Indicator

1. Press the [MENU] button to engage the Menu mode.
2. Rotate the [SELECT] knob to select Menu item "006 DISP BARSEL".

ADVICE:

Press the [SELECT] knob to toggle the Menu item display between "006 DISP" and "BARSEL".

3. Rotate the [CLAR/VFO-B] knob to select "u-trn (μ-Tune)" (replacing the default "C-trn (CW TUNING)" selection).
4. Press and hold in the [MENU] button for one second to lock in the new setting and exit to normal operation.

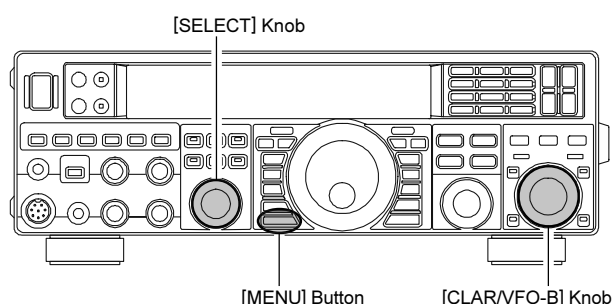

Advice

If you want to use an external bandpass filter or preamplifier, you may connect it between the μ-TUNE IN and μ-TUNE OUT jacks on the rear panel.

1. Connect the external equipment between the μ-TUNE IN and μ-TUNE OUT jacks on the rear panel.
2. Press the [μ-TUNE] button, then press the [SELECT] knob. The receive signal will pass through the external equipment. In this case, the "μ-TUNE" and "THRU" icons will be shown in the FLT column of the VFD display Block Diagram.

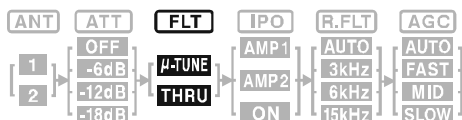

BLOCK DIAGRAM DISPLAY

3. Press the [μ-TUNE] button (or [SELECT] knob) again, the receive signal will bypass the external equipment and be applied directly to the transceiver front-end circuit. The "μ-TUNE" icon will disappear from the VFD display (only the "THRU" icon will be shown).

ADVICE:

Alternate presses of the [μ-TUNE] button or the [SELECT] knob, will switch the receive signal between the external equipment or the direct front-end receive circuit.

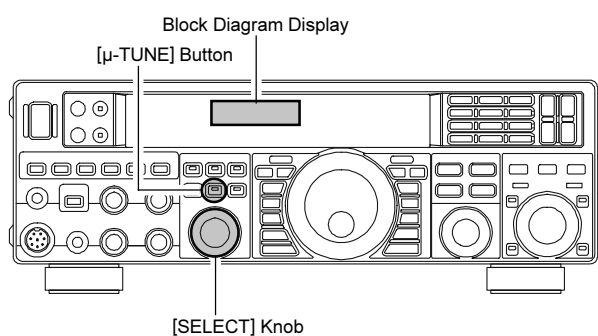

IMPORTANT NOTICE!

When [μ-TUNE] is enabled, the FT-950 cannot receive a signal without an external device of jumper cable between the μ-TUNE IN and μ-TUNE OUT jacks.

INTERFERENCE REJECTION

IPO (INTERCEPT POINT OPTIMIZATION)

The IPO feature allows the operator to optimize the characteristics of the receiver front end, depending on the current noise level and the strength of incoming signals.

Press the [IPO] button several times to set the desired characteristic of the receiver front end, according to the chart below.

- AMP1**: Amplifies the incoming signals, using a low distortion RF preamplifier (gain: approx. 10 dB).
- AMP2**: Amplifies the incoming signals, using a 2-stage low-distortion RF preamplifier (total gain: approx. 17 dB).
- ON**: Bypasses the RF preamplifier, yielding direct feed to the first mixer.

The selected receiver RF preamplifier will be indicated in the IPO column of the Block Diagram Display on the display.

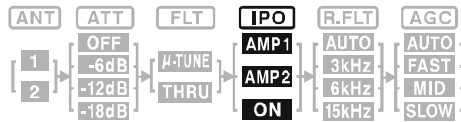

BLOCK DIAGRAM DISPLAY

ADVICE:

- The IPO selection will be memorized independently on each VFO stack of VFO-A and VFO-B.
- On the 10 MHz and lower bands, it generally is not necessary to use any preamplifier at all; selecting the “IPO ON” position as described above will increase the strong-signal-handling capability of the receiver, and generally will result in more pleasant reception due to reduced noise. If you can hear band noise with the preamplifiers disengaged, then a preamplifier is generally not needed.

NOTE:

The IPO feature is always on “IPO ON” (No RF preamplifier) between 30 kHz and 1.7 MHz.

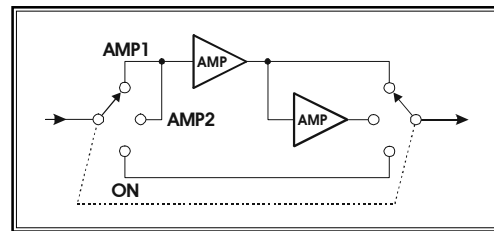
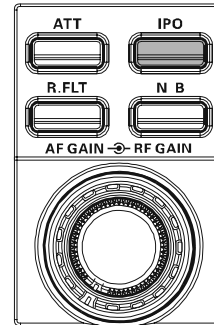
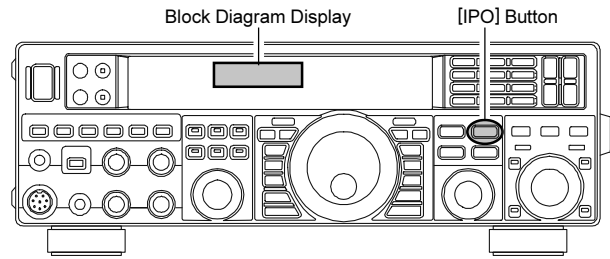

INTERFERENCE REJECTION

R.FLT (ROOFING FILTERS)

Narrow-band Roofing Filters of 15 kHz, 6 kHz, and 3 kHz bandwidths are provided in the first IF, right after the first mixer. These filters provide protection for the 2nd mixer, DSP, and other circuitry that follow and can dramatically improve reception on a very crowded band (during a contest, etc.). Typically, the AUTO selection mode is satisfactory for most operating situations, but in an extremely crowded phone band you may wish to select, for example, the 3 kHz roofing filter for SSB operation for SSB operation.

Press the [R.FLT] button to toggle the Roofing Filter selection.

AUTO → 15 kHz → 6 kHz → 3 kHz → AUTO

ADVICE:

- As you repeatedly press the [R.FLT] button, you will observe changes in the notation in the R.FLT column of the Block Diagram Display on the display, denoting the Roofing Filter currently in use.
- Typically, this selection will be set to “AUTO.”
- The Roofing Filter selection will be memorized independently on each VFO stack of VFO-A and VFO-B.

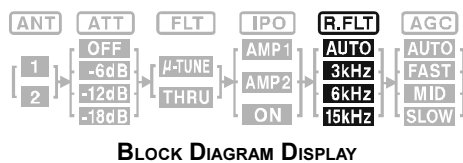

QUICK POINT:

The “AUTO” selection of the Roofing Filter is based on the operating mode. However, you may override the automatic selection, if band conditions warrant a different (usually, a tighter) selection.

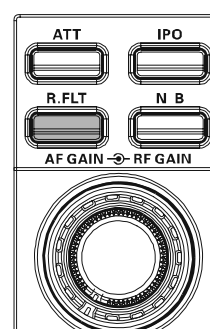
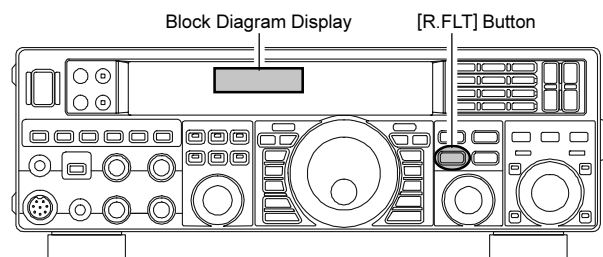

TERMINOLOGY:

A “Roofing Filter,” as its name implies, places a “Roof” over the receiver’s IF system bandwidth. This “Roof” protects the circuitry downstream from the first mixer from interference, just as a roof on a house protects the contents from rain and snow.

INTERFERENCE REJECTION

IF NOISE BLANKER (NB) OPERATION

The **FT-950** includes an effective IF Noise Blanker, which can significantly reduce noise caused by automotive ignition systems.

1. Press the **[NB]** button momentarily to reduce short duration pulse noise such as from switching transients, automobile ignitions and power lines. The “**NB**” icon will appear in the display to confirm that the Narrow-NB is operating. Press and hold in the **[NB]** button for two seconds to reduce longer-duration man-made pulse noise. The “**NB**” icon will blink for three seconds, and thereafter will appear continuously, to confirm that the Wide-NB is operating.
2. If desired, you may adjust the Noise Blanker level via Menu item “067 RGEN NB 1 LVL” (for short-duration pulse noise) or “068 RGEN NB 2 LVL” (for longer duration pulse noise) to the point where the offending noise is best reduced or eliminated. See box below for details.
3. To end Noise Blanker operation, press the **[NB]** button once more. The “**NB**” icon will turn off, confirming that the Noise Blanker is no longer in operation.

ADVICE:

The Noise Blanker operation will be memorized independently on each VFO stack of VFO-A and VFO-B. However, the Noise Blanker level is in common.

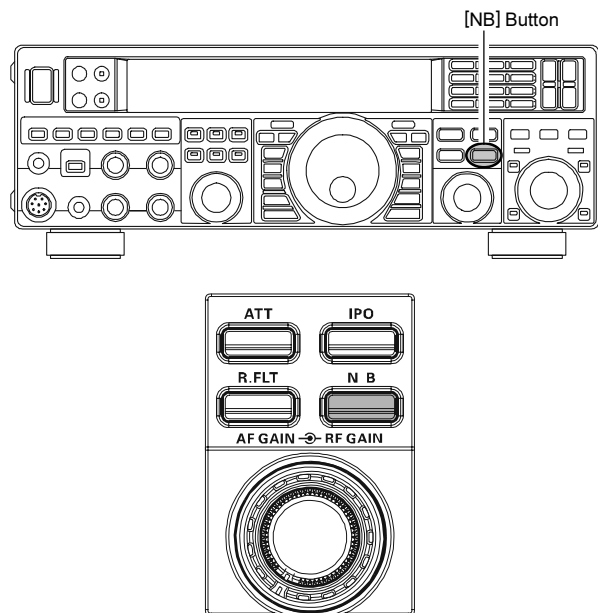

Adjusting the Noise Blanker Level

1. Press the **[MENU]** button to engage the Menu mode.
2. Rotate the **[SELECT]** knob to select Menu item “067 RGEN NB 1 LVL” (for short-duration pulse noise) or “068 RGEN NB 2 LVL” (for longer-duration pulse noise).

ADVICE:

Press the **[SELECT]** knob to toggle the display between “Menu Number & Menu Group Name” and “Menu Item”.

3. Rotate the **[CLAR/VFO-B]** knob to the point where the offending noise is best reduced or eliminated.
4. Press and hold in the **[MENU]** button for one second to lock in the new setting and exit to normal operation.

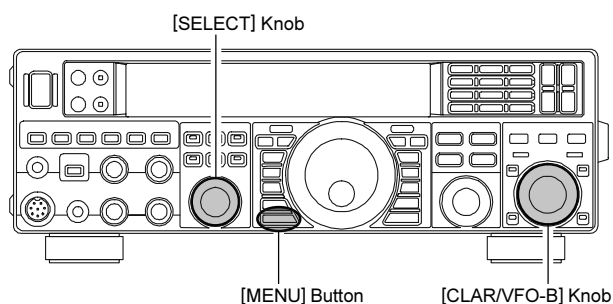

CONTOUR CONTROL OPERATION

The Contour filtering system provides a gentle perturbation of the IF filter passband. The Contour is set to either suppress, or boost specific frequency components, and thus enhance the sound and readability of a received signal.

1. Press the **[CONT]** button to activate the Contour filter. The LED inside the **[CONT]** button glows orange and the current “null” (or “peak”) position of the Contour filter will appear in the CONTOUR indicator on the display. The **[SELECT]** knob will now function as the Contour knob.

2. Rotate the **[SELECT]** knob to achieve the most natural-sounding audio reproduction on the incoming signal.

ADVICE:

The frequency display will show the Contour frequency for 3 seconds whenever the **[SELECT]** knob is turned.

3. Press the **[CLEAR]** button to move the “null” (or “peak”) position to center.

4. To cancel Contour tuning, press the **[CONT]** button (or **[SELECT]** knob) momentarily. The graphic disappears from the CONTOUR indicator on the display, confirming that the Contour filter is no longer in operation.

ADVICE:

Alternate presses of the **[CONT]** button or the **[SELECT]** knob, will switch the Contour filter between on or off.

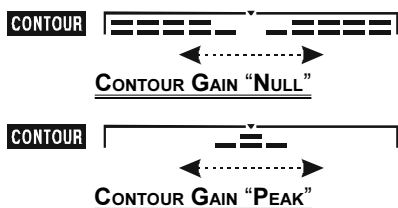
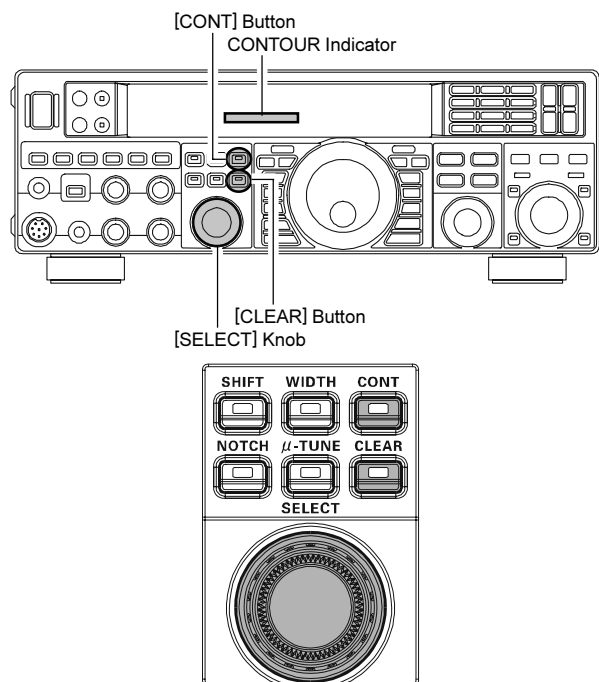

ADVICE:

- The Contour filter selection will be memorized independently on each VFO stack of VFO-A and VFO-B.
- The Contour filter level (either a null or a peak) may be adjusted using Menu item “069 RGEN CNTR LV”. The factory default setting is for a null of -15 (dB).
- The bandwidth over which the Contour filter effect is applied may be adjusted using Menu item “070 RGEN CNTR WI”. The factory default setting is 10.
- When the optional **DMU-2000** Data Management Unit is connected, the Audio Scope (on the “Oscilloscope” page) is particularly useful when adjusting the Contour control. Not only can you see the effect of the null/peak of the Contour system, but you also can see the position of the null/peak with respect to frequency components of interest on the incoming signal. You may then observe (on the Audio Scope) the effect of the Contour control while listening to the effect on the signal, and this will help build your intuition on how best to use Contour tuning in the future.

QUICK POINT:

The steep slopes of the DSP filtering, when adjusted aggressively, can impart an unnatural sound to an incoming signal. Often, a narrow bandwidth is not the key to improving copy; the incoming signal itself may have undesirable or excessive frequency components, especially in the low frequency range around 100-400 Hz. By judicious use of the Contour filter, the “shoulder” of the passband response may be altered, or components may be removed from within the passband, allowing the desired signal to rise above the background noise and interference in a manner not obtainable with other filtering systems.

Refer to Figure “B”, this illustrates an “indentation” of the Contour filter in the center of the passband. The Contour filter is placing a low-Q “notch” (per the setting of Menu item “069 RGEN CNTR LV”, referenced above) in the passband. Counterclockwise rotation (to the left) of the **[SELECT]** knob causes the notch to move toward a lower frequency within the passband, while clockwise rotation (to the right) causes the notch to move toward a higher frequency within the passband. By removing interference or unwanted frequency components of the incoming signal, it is possible to make the desired signal rise out of the background noise/interference, enhancing intelligibility.

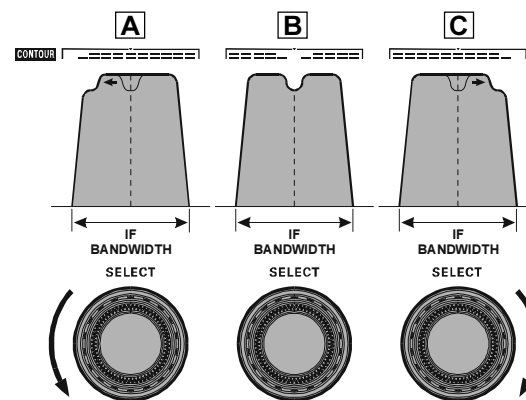

INTERFERENCE REJECTION

IF SHIFT OPERATION (SSB/CW/RTTY/PKT/AM MODES)

IF SHIFT allows you to move the DSP filter passband higher or lower, without changing the pitch of the incoming signal, and thus reduce or eliminate interference. Because the carrier tuning frequency is not varied, there is no need to re-tune the operating frequency to eliminate the interference. The total passband tuning range for the IF SHIFT system is ± 1 kHz.

1. Press the **[SHIFT]** button. The LED inside the **[SHIFT]** button glows orange. The **[SELECT]** knob functions as the IF SHIFT knob. The center position of the IF passband appears in the SHIFT indicator on the display.
2. Rotate the **[SELECT]** knob to the left or right to reduce the interference.

ADVICE:

The frequency display will show the shift value of the IF SHIFT for 3 seconds whenever the **[SELECT]** knob is turned.

3. Press the **[CLEAR]** button to move the filter passband to center.

ADVICE:

The center position of the IF passband will be memorized independently on each VFO stack of VFO-A and VFO-B.

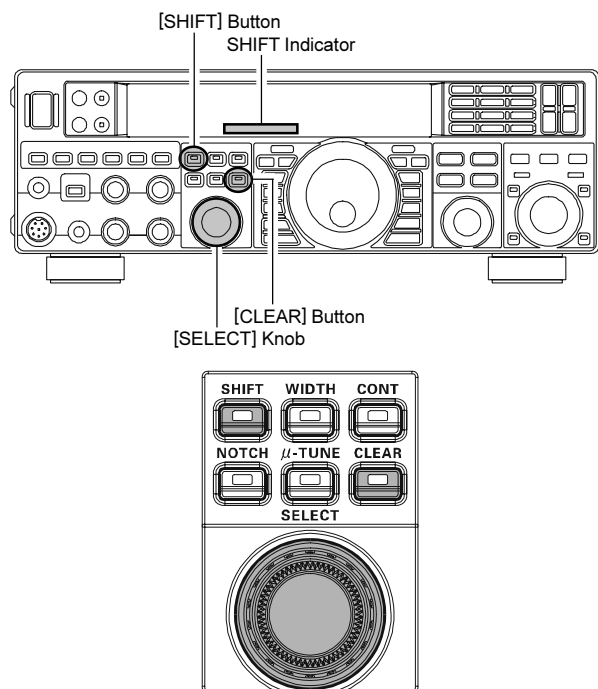

Referring to Figure “**A**”, note the depiction of the IF DSP filter as the thick line, with the **[SELECT(SHIFT)]** knob in the 12 o’clock position. In Figure “**B**”, an interfering signal has appeared inside the original passband. In Figure “**C**”, you can see the effect of rotating the **[SELECT(SHIFT)]** knob. The interference level is reduced by moving the filter passband so that the interference is outside of the passband.

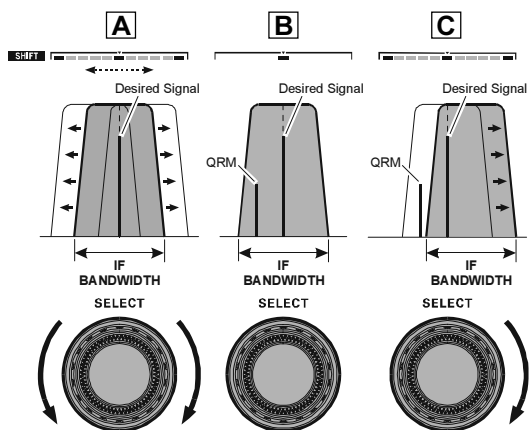

WIDTH (IF DSP BANDWIDTH) TUNING (SSB/CW/RTTY/PKT MODES)

The IF WIDTH tuning system allows you to vary the width of the DSP IF passband, to reduce or eliminate interference. Moreover, the bandwidth may actually be *expanded* from its default setting, should you wish to enhance incoming signal fidelity when interference on the band is low.

1. Press the **[WIDTH]** button. The LED inside the **[WIDTH]** button glows orange. The **[SELECT]** knob functions as the WIDTH knob. The current bandwidth appears in the WIDTH indicator on the display.

2. Rotate the **[SELECT]** knob to the left or right to reduce the interference.

ADVICE:

The frequency display will show the bandwidth of the IF passband for 3 seconds whenever the **[SELECT]** knob is turned.

3. Press the **[CLEAR]** button to set the bandwidth to default.

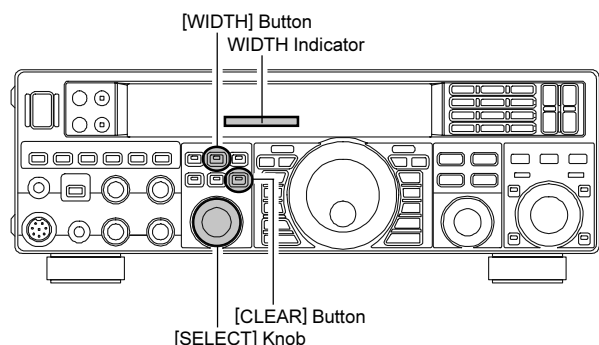
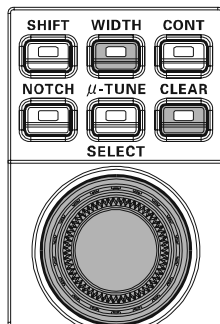

ADVICE:

The IF Bandwidth will be memorized independently on each VFO stack of VFO-A and VFO-B.

Referring to Figure "B", you can see the default bandwidth on the SSB mode by pressing the **[CLEAR]** button.

By rotating the **[SELECT(WIDTH)]** knob to the left, the bandwidth will narrow (see Figure "A", while rotation of the **[SELECT(WIDTH)]** knob to the right, as depicted in Figure "C", will increase the bandwidth.

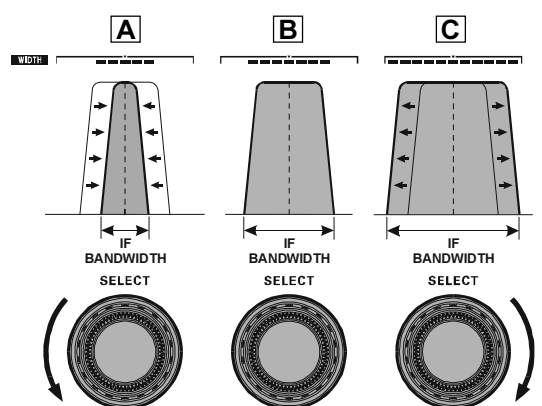

The default bandwidths, and total bandwidth adjustment range, will vary according to the operating mode:

- SSB Mode: 1.8 kHz ~ 3.0 kHz (default: 2.4 kHz).
- CW Mode: 500 Hz ~ 2.4 kHz (default: 2.4 kHz)
- RTTY/PKT Modes: 500 Hz ~ 2.4 kHz (default: 500 Hz)

Using IF SHIFT and WIDTH Together

The IF SHIFT and Variable IF WIDTH features together form a very effective interference-fighting filtering system.

For example, in Figure "A", you can see how interference has appeared both on the high and low sides of the desired signal. Press the **[WIDTH]** button then rotate the **[SELECT(WIDTH)]** knob, the interference from one side can be eliminated (Figure "B"). Next, press the **[SHIFT]** button and rotate the **[SELECT(SHIFT)]** knob to re-positioning the passband (Figure "C"), the interference on the opposite side can be removed, without re-introducing the interference previously eliminated in Figure "B".

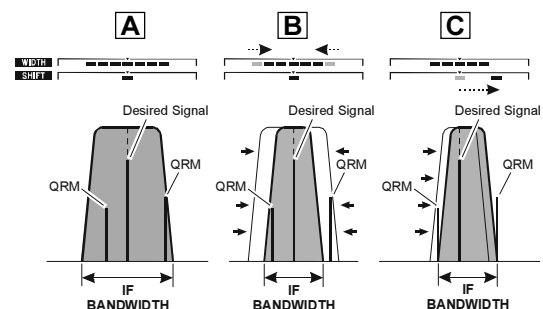

ADVICE:

For best interference reduction, the WIDTH and SHIFT features are the primary tools you should use. After narrowing the bandwidth (WIDTH) and/or adjusting the center of the passband (SHIFT). The Contour control may then yield additional signal-enhancement benefits on the net residual bandwidth. Even more, the IF NOTCH Filter (described later) may also be used, in conjunction with these filter systems, to significant advantage.

INTERFERENCE REJECTION

NARROW (NAR) ONE-TOUCH IF FILTER SELECTION

Pressing the **[NAR]** button provides one-touch, mode-specific, selection of a narrow IF DSP filter setting that does not require resetting the **[SELECT(WIDTH)]** knob.

Pressing the **[NAR]** button once more returns the bandwidth control to the WIDTH/SHIFT system. The factory default bandwidths are:

| OPERATING MODE | [NAR] SWITCH | |
|----------------------|--------------------------------|--------------------------------|
| | "ON" | "OFF" |
| SSB | 200 Hz ~ 1.8 kHz* (1.8 kHz) | 1.8 ~ 3.0 kHz* (2.4 kHz) |
| CW | 100 ~ 500 Hz* (500 Hz) | 500 Hz ~ 2.4 kHz* (2.4 kHz) |
| RTTY/PKT-L/PKT-U | 100 ~ 500 Hz* (300 Hz) | 500 Hz ~ 2.4 kHz* (500 Hz) |
| PKT-FM | 9 kHz | 16 kHz |
| AM | 6 kHz | 9 kHz |
| FM (28/50 MHz Bands) | 9 kHz | 16 kHz |

*: Depends on the **[WIDTH]** knob
(): Default Bandwidth

ADVICE:

- When the narrow bandwidth is selected, the "**NAR**" icon will appear in the display.
- Even if the **[NAR]** button has been pressed to engage the narrow filter, you may adjust the narrow IF bandwidth by rotating the **[SELECT(WIDTH)]** knob (requires pressing the **[WIDTH]** button). The IF SHIFT still is operational (requires pressing the **[SHIFT]** button). For many applications, you may find that simply pressing the **[NAR]** button instead of adjustment of the **[SELECT(WIDTH)]** knob, may be satisfactory for interference reduction.
- When you press the **[NAR]** button in the FM mode, both transmit and receive bandwidths are narrowed.

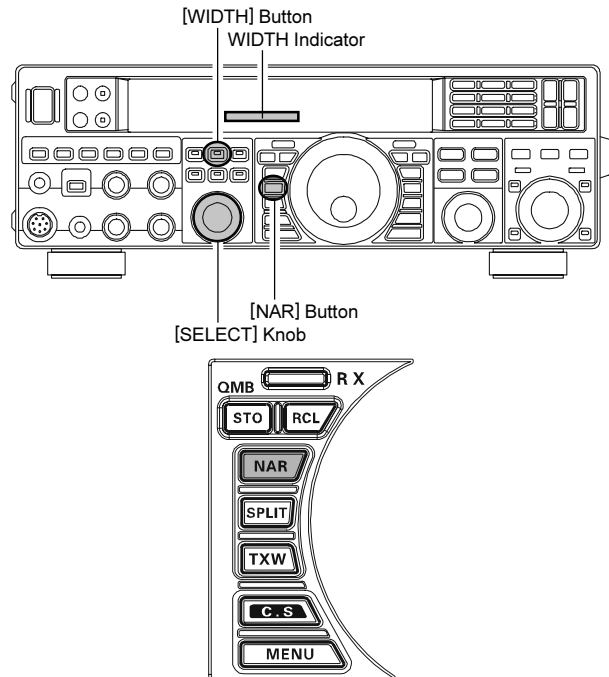

INTERFERENCE REJECTION

IF NOTCH FILTER OPERATION (SSB/CW/RTTY/PKT/AM MODES)

The IF NOTCH filter is a highly effective system that allows you to slice out an interfering beat note or other carrier signal from inside the receiver passband.

1. Press the **[NOTCH]** button to activate the Notch filter. The LED inside the **[NOTCH]** button glows orange and the current “null” position of the NOTCH filter will appear in the NOTCH indicator on the display. The **[SELECT]** knob functions as the Notch adjustment knob.
2. Rotate the **[SELECT]** knob to adjust the “null” position of the Notch filter.

ADVICE:

The frequency display will show the Notch frequency for 3 seconds whenever the **[SELECT]** knob is turned.

3. Press the **[CLEAR]** button to move the “null” position to center.
4. To cancel the NOTCH filter, press the **[NOTCH]** button (or **[SELECT]** knob) momentarily. The graphic disappears from the NOTCH indicator on the display, confirming that the NOTCH filter is no longer operation.

ADVICE:

Alternate presses of the **[NOTCH]** button or the **[SELECT]** knob, will switch the NOTCH filter between on or off.

ADVICE:

- ❑ The IF NOTCH Filter selection will be memorized independently on each VFO stack of VFO-A and VFO-B.
- ❑ When the optional **DMU-2000** Data Management Unit is connected, the effect of the IF NOTCH filter may be observed on the Audio Scope (on the “Oscilloscope” page). The Notch will be observed as a “dip” in the noise platform observed. What’s more, the “Waterfall” display may be used to observe the effect of the IF NOTCH filter, which will appear as a white area in the colored background area.

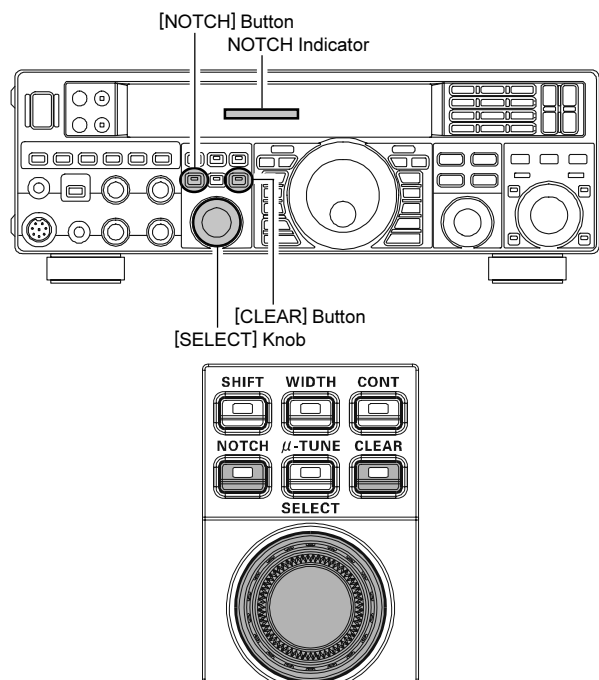

The performance of the IF NOTCH filter is shown in Figure “A”, where the effect of rotation of the **[SELECT(NOTCH)]** knob is depicted. In Figure “B” you can see the notching effect of the IF NOTCH filter as you rotate the **[SELECT(NOTCH)]** knob to eliminate the incoming interference.

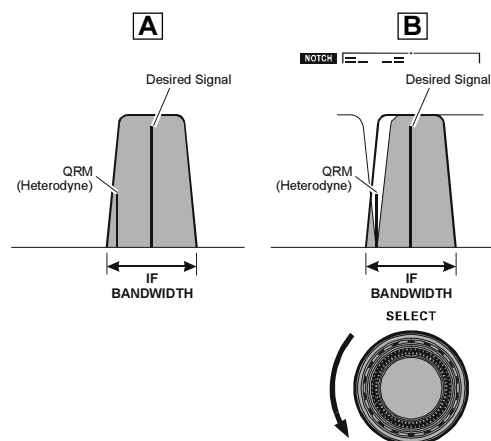

INTERFERENCE REJECTION

DIGITAL NOTCH FILTER (DNF) OPERATION

The Digital NOTCH Filter (DNF) is an effective beat-canceling filter that can null out a number of interfering beat notes inside the receiver passband. Because this is an Auto-Notch feature, there is no adjustment knob associated with this filter.

ADVICE:

If a very strong interfering carrier is encountered, we recommend you first use the IF NOTCH filter, as it is the most effective notching tool in the receiver section.

1. Press the **[MENU]** button to enter the Menu mode.
2. Rotate the **[SELECT]** knob to select Menu item “071 RGEN DNF”.

ADVICE:

Press the **[SELECT]** knob to toggle the Menu item display between “071 RGEN” and “DNF”.

3. Rotate the **[CLAR/VFO-B]** knob to select “ON”. The “**DNF**” icon will appear in the display.
4. Press and hold in the **[MENU]** button for one second to save the new setting and exit to normal operation.

To disable the Digital NOTCH Filter, just repeat the above procedure, rotating the **[CLAR/VFO-B]** knob to select “OFF” in step 3 above. The “**DNF**” icon will turn off, confirming that the Digital NOTCH Filter is not active.

ADVICE:

The Digital NOTCH Filter selection will be memorized independently on each VFO stack of VFO-A and VFO-B.

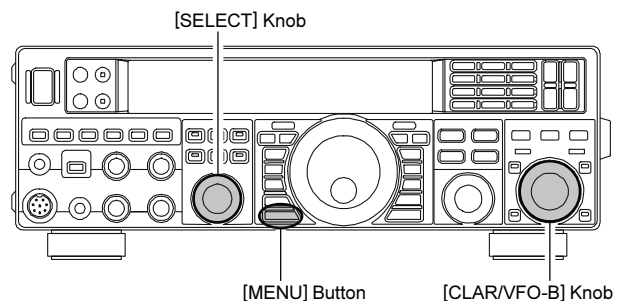

DIGITAL NOISE REDUCTION (DNR) OPERATION

The Digital Noise Reduction (DNR) system is designed to reduce the level of random noise found on the HF and 50 MHz bands, and it is especially effective during SSB operation. By setting the Menu item “072 RGEN DNR”, any of 15 different noise-reduction algorithms can be selected; each of these algorithms was created for dealing with a different noise profile, and you will want to experiment with the DNR system to find the best setting according to the noise currently being experienced.

1. Press the **[MENU]** button to enter the Menu mode.
2. Rotate the **[SELECT]** knob to select Menu item “072 RGEN DNR”.

ADVICE:

Press the **[SELECT]** knob momentarily to toggle the Menu item display between “072 RGEN” and “DNR”.

3. Rotate the **[CLAR/VFO-B]** knob to select the setting that most effectively reduces the noise level. The “**DNR**” icon will appear in the display.
4. Press and hold in the **[MENU]** button for one second to save the new setting and exit to normal operation.

To disable the DNR system, just repeat the above procedure, rotating the **[CLAR/VFO-B]** knob to select “OFF” in step 3 above. The “**DNR**” icon will turn off, confirming that the DNR system is not active.

ADVICE:

The Digital Noise Reduction will be memorized independently on each VFO stack of VFO-A and VFO-B.

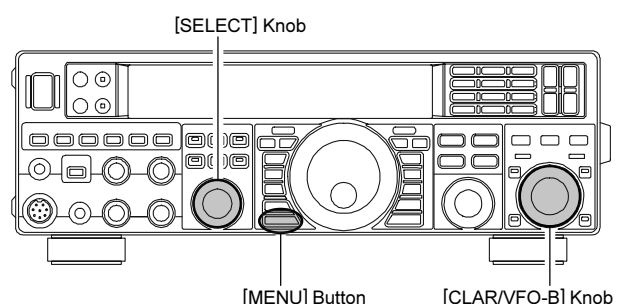

INTERFERENCE REJECTION

RF GAIN (SSB/CW/AM MODES)

The RF Gain control provides manual adjustment of the gain levels for the receiver RF and IF stages, to account for noise and signal strength conditions at the moment.

1. The [RF GAIN] knob should, initially, be rotated to the fully clockwise position. This is the point of maximum sensitivity.
2. Counter-clockwise rotation of the [RF GAIN] knob will gradually reduce the system gain.

ADVICE:

- ❑ As the [RF GAIN] knob is rotated counterclockwise to reduce the gain, the S-meter reading will rise. This indicates that the AGC voltage being applied to the receiver is increasing (which causes a *reduction* in receiver gain).
- ❑ Rotating the [RF GAIN] knob control to the fully counter-clockwise position will essentially disable the receiver, as the gain will be greatly reduced. In this case, the S-meter will appear to be “pegged” against the right edge of the analog S-meter scale.

QUICK POINT:

- ❑ Reception frequently can be optimized by rotating the [RF GAIN] knob slightly counter-clockwise to the point where the “stationary” meter indication is set just about the same as the incoming noise level. This setting ensures that excessive gain is not being utilized, without so much gain reduction that incoming signals cannot be heard.
- ❑ The RF Gain control, along with the IPO and the Attenuator features, all affect the system receiver gain in different ways. The IPO generally should be the first feature engaged when dealing with a high noise level, or a crowded, high-level signal environment, the IPO generally should be the first feature engaged, if the frequency is low enough to allow the preamplifier to be bypassed. Thereafter, the RF Gain and Attenuator features may be employed to provide precise, delicate adjustment of the receiver gain to fully optimize performance.

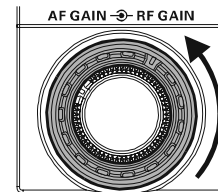
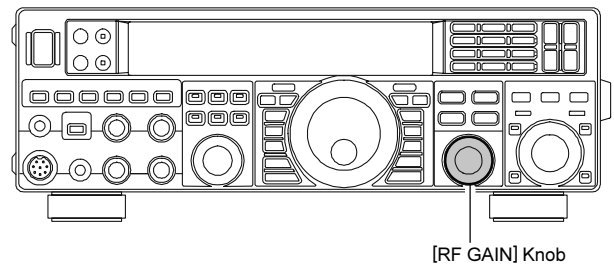

TOOLS FOR COMFORTABLE AND EFFECTIVE RECEPTION

AUDIO PITCH CONTROL (SSB MODE)

The **FT-950** permits adjustment of the receiver audio response by shifting the carrier point during SSB operation.

1. Press the **[MENU]** button to enter the Menu mode.
2. Rotate the **[SELECT]** knob to select Menu item “065 J3E LSB CAR” or “066 J3E USB CAR”.

ADVICE:

Press the **[SELECT]** knob momentarily to toggle the Menu item display between “Menu Item Number & Group Name” and “Menu Function”.

3. Rotate the **[CLAR/VFO-B]** knob to adjust the receiver audio response as desired.
4. Press and hold in the **[MENU]** button for one second to save the new setting and exit to normal operation.

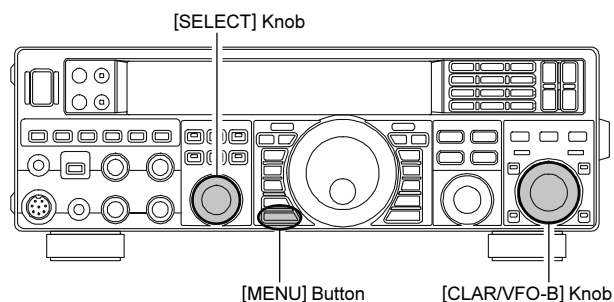

MUTE FEATURE

There may be occasions when you want to silence the receiver audio of the **FT-950**, perhaps to concentrate on another receiver or telephone call. The Mute feature makes this simple to accomplish.

VFO-A/Memory Mute

Press the **[(VFO-A)RX]** Indicator/Switch, while receiving the VFO-A frequency or Memory channel. The **FT-950** will be silenced and the green LED in the **[(VFO-A)RX]** Indicator/Switch will blink.

To restore reception, just press the blinking **[(VFO-A)RX]** Indicator/Switch once more.

VFO-B Mute

While receiving the VFO-B frequency, press the **[(VFO-B)RX]** Indicator/Switch. The **FT-950** will be silenced and the green LED in the **[(VFO-B)RX]** Indicator/Switch will blink.

To restore reception, just press the blinking **[(VFO-B)RX]** Indicator/Switch once more.

ADVICE:

If you press the **[POWER]** switch momentarily while the transceiver is turned on, the transceiver's audio will be muted for three seconds.

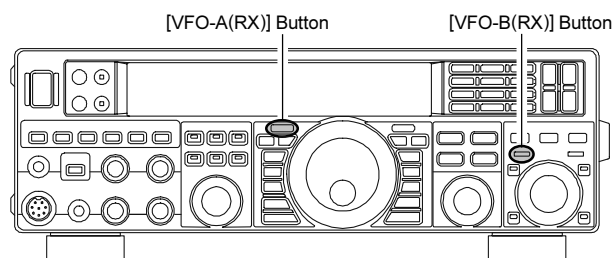

TOOLS FOR COMFORTABLE AND EFFECTIVE RECEPTION

AGC (AUTOMATIC GAIN CONTROL)

The AGC system is designed to help compensate for fading and other propagation effects. The AGC characteristics can be individually set for each operating mode. The basic objective of AGC is to maintain a constant audio output level once a certain minimum threshold of signal strength is achieved.

Press the **[AGC]** button repeatedly to select the desired receiver-recovery time constant. You will observe the AGC status notation in the AGC column of the Block Diagram Display on the display, denoting the AGC receiver-recovery time currently in use. For most operations, we recommend the “AUTO” mode. Additionally, you may disable the AGC by pressing and holding in the **[AGC]** button for one second.

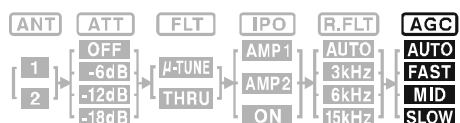

BLOCK DIAGRAM DISPLAY

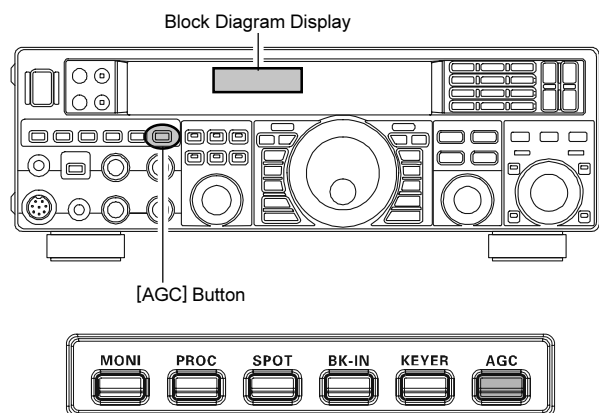

NOTE:

Pressing the **[AGC]** button allows selection of the desired receiver-recovery time constant. Normally, the “AUTO” selection is satisfactory for most situations, but in the event of operation on a crowded band where you wish to receive a weak signal, you may wish to change the setting to FAST. The AUTO mode selections are:

| OPERATING MODE | AUTO AGC SELECTION |
|----------------|--------------------|
| LSB | SLOW |
| USB | SLOW |
| CW | FAST |
| AM | FAST |
| FM | FAST |
| RTTY | SLOW |
| PKT (FM) | FAST |
| PKT (LSB) | SLOW |

ADVICE:

- ❑ The AGC selection will be memorized independently on each VFO stack of VFO-A and VFO-B.
- ❑ If the AGC receiver-recovery time is set to “Off” by pressing and holding in the **[AGC]** button, the S-meter will no longer deflect. Additionally, you will likely encounter distortion on stronger signals, as the IF amplifiers and the following stages are probably being overloaded.

QUICK POINT:

Several aspects of AGC performance may be configured via the Menu. However, because AGC can have such a profound impact on overall receiver performance, we generally do not recommend any changes to the AGC Menu selections until you are thoroughly familiar with the performance of the **FT-950**.

TERMINOLOGY:

Automatic Gain Control, or AGC, is a circuit that senses the incoming signal strength, and then limits the gain of the RF and IF stages to keep the output audio volume at a more-or-less constant level. AGC also protects the RF, IF, Audio, and DSP stages from overload, as it limits the signal strength that is allowed to flow, irrespective of the input signal level.

SSB/AM MODE TRANSMISSION

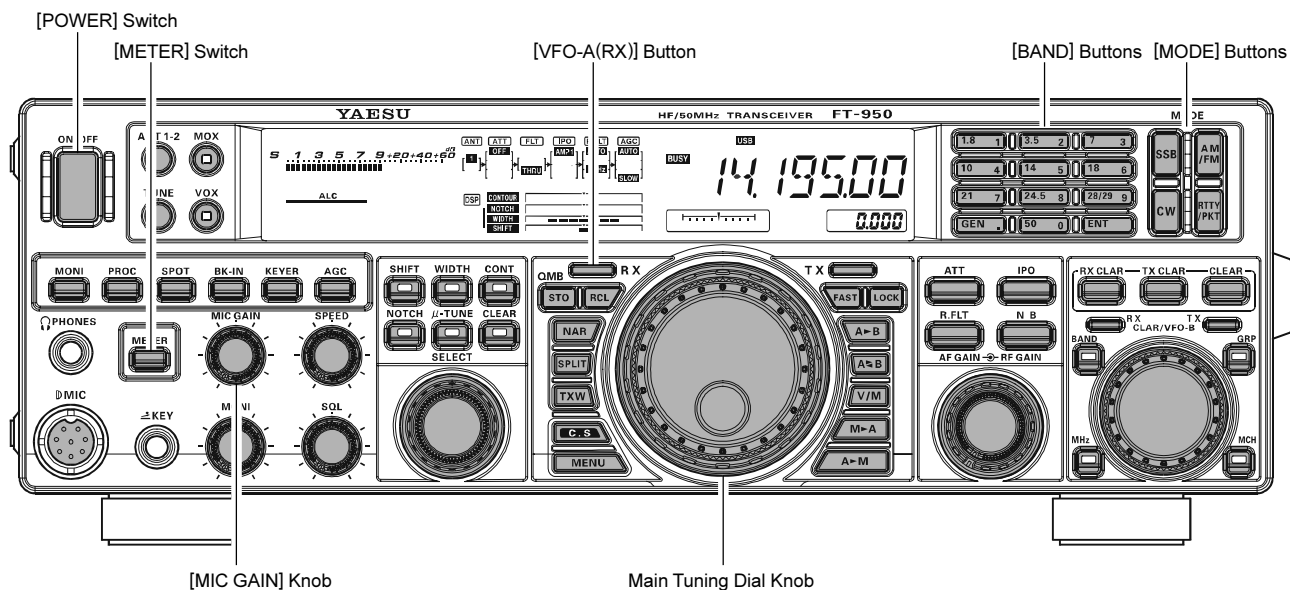

1. Press the **[BAND]** button corresponding to the Amateur band on which you wish to operate.

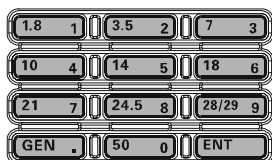

2. Press the **[SSB]** button for SSB operation. For AM operation press the **[AM/FM]** button repeatedly until the “**AM**” icon appears in the display.

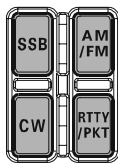

ADVICE:

By convention, LSB is used in the 7 MHz and lower Amateur bands for SSB communication, and USB is used on the 14 MHz and higher bands (the 10 MHz band is used for CW and data modes only).

3. Rotate the Main Tuning Dial knob to adjust the operating frequency. Alternately, you may use the **[UP]/[DWN]** scanning buttons on the **MH-31B8** Hand Microphone to sweep up or down the current band.
4. Press the microphone’s **PTT** (Push To Talk) switch to begin transmission; speak into the microphone in a normal voice level.

ADVICE:

- The “**T X**” indicator will light up in the frequency display area, confirming that transmission is in progress.
- When transmitting in the AM mode, set a maximum (carrier) power output of 25 Watts via the Menu item “112 TGEN AM CAR”. See Box on the next page for details of the setting.

5. Adjust the microphone amplifier gain to match the microphone and your voice level: press the **[METER]** switch repeatedly to select the “ALC” meter, close the **PTT** switch, and speak into the microphone in a normal voice level.



In the SSB mode, adjust the **[MIC GAIN]** knob so that the ALC meter stays within the ALC zone of the meter (up to half scale deflection) on voice peaks.



In the AM mode, adjust the **[MIC GAIN]** knob so that the ALC meter does not deflect at voice peaks.

ADVICE:

The frequency display will show the relative microphone gain level for 3 seconds whenever the **[MIC GAIN]** knob is turned.

6. Release the **PTT** switch at the end of your transmission. The transceiver will return to the receive mode.

SSB/AM MODE TRANSMISSION

ADVICE:

- ❑ ALC meter deflection may be caused by excessive drive power, but also by reflected power detected in the antenna system. If the impedance presented to the transceiver is different from 50 Ohms, ALC meter action may be observed that is not related to the proper setting of the [MIC GAIN] knob. Therefore, we recommend that you make the [MIC GAIN] knob adjustments into a dummy load or antenna system presenting impedance very close to 50 Ohms.
- ❑ **In the SSB mode**, you may set the desired power output via the Menu item “111 TGEN TX PWR”. The adjustment range is between 5 Watts and 100 Watts. You should always use the minimum power necessary to maintain reliable communications.
- ❑ When performing “on air” tests (such as the setup of microphone gain), be sure to check the frequency before transmitting, to avoid interference to others who may already be using the frequency.

- ❑ Four techniques for exercising Transmit/Receive control are provided on the **FT-950**. You may choose the technique(s) that best suit your operating needs:
 - Pressing the microphone **PTT** switch will engage the transmitter.
 - The rear panel **PTT** jack may be connected to a foot switch or other manual switching device in order to engage the transmitter.
 - Pressing the front panel [MOX] button will lock the transmitter on. Press the [MOX] button again to return to receive.
 - The VOX (Voice Operated Xmit) circuit will engage the transmitter automatically when you speak into the microphone. For details of VOX operation, see page 66.

Adjusting the SSB TX Power Output

1. Press the [MENU] button to enter the Menu mode.
2. Rotate the [SELECT] knob to select Menu item “111 TGEN TX PWR”.

ADVICE:

If necessary, press the [SELECT] knob to toggle the Menu item display between “111 TGEN” and “TX PWR”.

3. Close the **PTT** switch, and then rotate the [CLAR/VFO-B] knob to adjust the desired power output on the Multi-Display Window.

ADVICE:

The value (5 -100) displayed in the Multi-Display window is a relative percentage of the maximum TX power available in the selected mode. It is not the true TX output level.

4. Press and hold in the [MENU] button for one second to save the new setting and exit to normal operation.

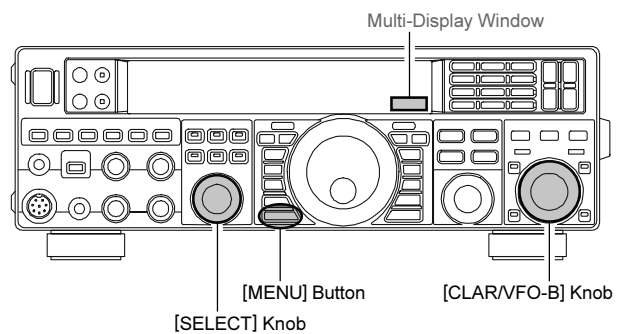

ADVICE:

The TX Power Output setting cannot be stored in any of the memory channels.

Adjusting the AM Carrier

1. Press the [MENU] button to enter the Menu mode.
2. Rotate the [SELECT] knob to select Menu item “112 TGEN AM CAR”.

ADVICE:

Press the [SELECT] knob to toggle the Menu item display between “112 TGEN” and “AM CAR”.

3. Close the **PTT** switch. Do not speak into the microphone. Rotate the [CLAR/VFO-B] knob to adjust the PO meter reading is “25 W”.

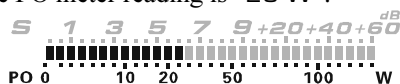

4. Press and hold in the [MENU] button for one second to save the new setting and exit to normal operation.

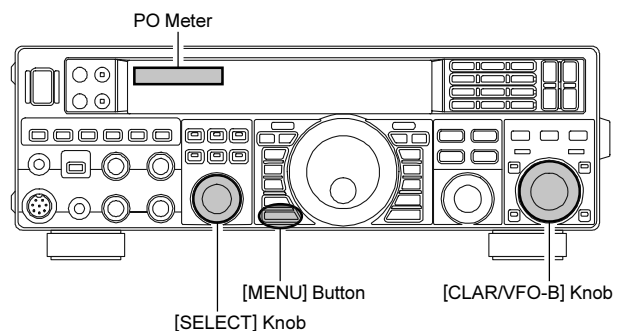

ADVICE:

The AM TX Power Output setting cannot be stored in any of the memory channels.

USING THE AUTOMATIC ANTENNA TUNER

The Automatic Antenna Tuner (hereinafter referred to as the “ATU”) built into each **FT-950** is designed to ensure a 50-Ohm load for the final amplifier stage of the transmitter. We recommend that the ATU be used whenever you operate on the **FT-950**.

ADVICE:

- ❑ Because the ATU of the **FT-950** is located inside the station, it only adjusts the impedance presented to the transceiver at the station end of your coaxial cable feedline. It does not “tune” the SWR at the antenna feed point itself. When designing and building your antenna system, we recommend that every effort be made to ensure a low SWR at the antenna feed point.
- ❑ The ATU of the **FT-950** includes 100 memories for tuning data. Eleven of these memories are allocated, one per Amateur band, so that each band has at least one setting preset for use on that band. The remaining 89 memories are reserved for the 89 most-recent tuning points, for quick frequency change without the need to retune the ATU.
- ❑ The ATU in the **FT-950** is designed to match impedances within the range of 16.5 Ohms to 150 Ohms, corresponding to an SWR of 3:1 or less on the 160 through 6 meter amateur bands. Accordingly, simple non-resonant whip antennas, along with random-length wires and the “G5RV” antenna (on most bands) may not be within the impedance matching range of the ATU.

ATU OPERATION

1. Use the Main Tuning Dial knob to set the radio to the desired operating frequency within the Amateur band.
2. Press the **[TUNE]** button momentarily to place the ATU in the transmit line (no adjustment/tuning will occur yet). The “**TUNER**” icon will appear in the display.

QUICK POINT:

The momentary press of the **[TUNE]** button will turn the tuner on, and the microprocessor will automatically select the tuning point closest to the current operating frequency.

3. Press and hold in the **[TUNE]** button for one second to begin automatic tuning. The transmitter will be engaged, and the “**TUNER**” icon will blink while tuning is in progress. When the optimum tuning point has been reached, the radio will return to receive, and the “**TUNER**” icon will again glow steadily (instead of blinking).
4. To disconnect the ATU from the transmit line, press the **[TUNE]** button momentarily. The “**TUNER**” icon will turn off, confirming that the ATU has been turned off. In the “Off” mode, the transceiver will be directly connected to the coaxial cable connected to your antenna, and will operate based on whatever impedance is present at the station end of the coax.

ADVICE:

The ATU circuit is located between the final amplifier and the rear-panel antenna jack; reception is not affected by the ATU.

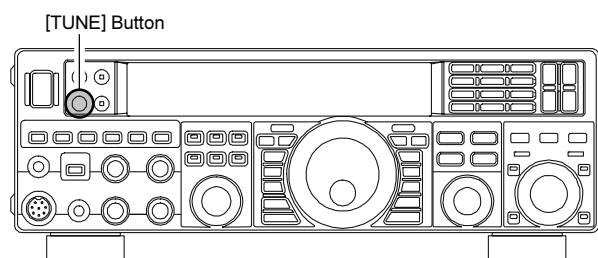

QUICK POINTS:

As shipped from the factory, only one ATU alignment point is saved on each Amateur band. This was memorized during the final alignment and performance verification stages on the production line.

NOTE:

Please check the operating frequency before beginning the tuning process, to be sure you are not interfering with others who may already be using the frequency.

TERMINOLOGY:

Antenna Tuner Memories: The microprocessor of the ATU makes a note of the positions of the tuning capacitors and the selected inductors, and stores the data for each 10 kHz window in which tuning has occurred. This eliminates the need to re-tune every time you return to a frequency on which you have already completed the tuning process.

USING THE AUTOMATIC ANTENNA TUNER

ABOUT ATU OPERATION

Figure 1 depicts a situation where normal tuning via the ATU has been successfully completed, and the tuning data has been stored in the ATU memory. The antenna system as seen by the transmitter is shown.

In Figure 2, the operator has changed frequency, and the “**HI-SWR**” icon has appeared. The operator presses and holds in the [TUNE] button for two seconds to begin impedance matching using the ATU.

If a high SWR condition exists (above 3:1), corrective action must be taken in the antenna system to bring the impedance closer to 50 Ohms. The ATU will refuse to memorize settings on frequencies where the SWR exceeds 3:1. A High SWR may indicate a mechanical failure in the feed system, and can lead to the generation of spurious signals causing TVI, etc.

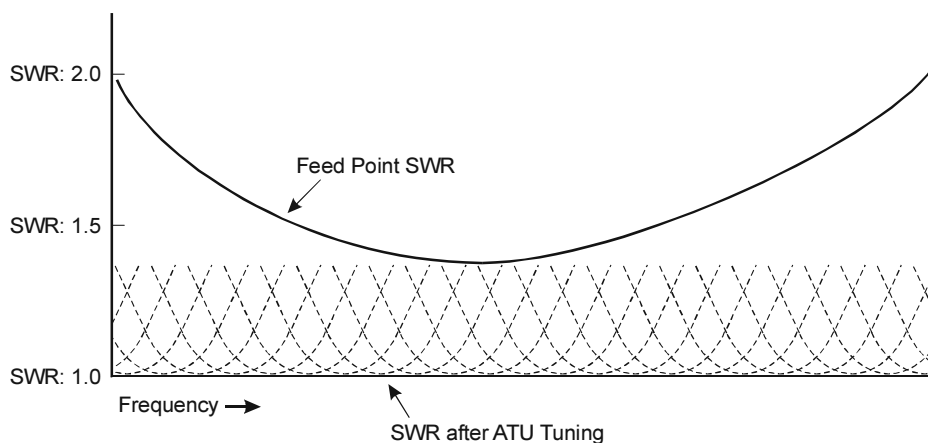

FIGURE 1

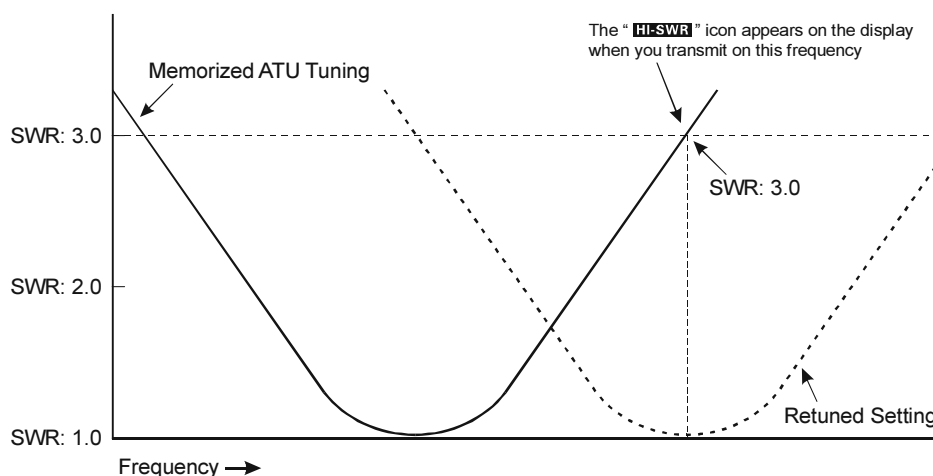

FIGURE 2

About ATU Memories

SWR (After tuning) Less than 1.5:1

The tuner settings are stored in the ATU memory.

SWR (After tuning) Greater than 1.5:1

Tuning data will not be retained in memory. If you return to the same frequency, the tuning process must be repeated.

SWR (After tuning) Greater than 3:1

The “**HI-SWR**” icon will light up, and the tuner settings, if achieved, will not be memorized. Please investigate the high SWR condition and resolve the problem, before attempting further operation using this antenna.

ENHANCING TRANSMIT SIGNAL QUALITY

PARAMETRIC MICROPHONE EQUALIZER (SSB/AM/FM MODE)

The **FT-950** includes a unique Three-Band Parametric Microphone Equalizer that provides precise, independent control over the low, mid and treble ranges in your voice waveform. You may utilize one group of settings when the speech processor is off and an alternate group of settings when the speech processor is on. The speech processor feature is described in the next chapter.

QUICK POINT:

The Parametric Equalizer is a unique technique for adjusting the signal quality. The three audio ranges may be adjusted so precisely, it is possible to craft an audio response that provides a natural and pleasant sound that you may not have ever experienced before. Alternately, the Effective “talk power” can be significantly enhanced.

The aspects of configuration that you may adjust on the Parametric Equalizer are:

Center Frequency: The center frequency of each of the three bands may be adjusted.

Gain: The amount of enhancement (or suppression) within each band may be adjusted.

Q: The bandwidth over which the equalization is applied may be adjusted.

Setup of the Parametric Microphone Equalizer

1. Connect the microphone to the **MIC** jack.
2. Set the RF output power to minimum value via the Menu item “1 11 TGEN TX PWR”, so you will not cause interference to other users while making adjustments.

ADVICE:

- We recommend that you connect a dummy load to one of the Antenna jacks, and monitor your signal on a separate receiver, to prevent interference to other users.
 - You will have the best chance of hearing the effects of adjustments if you wear headphones (connected to the monitor receiver) while listening to your transmitted signal.
3. To adjust the Parametric Microphone Equalizer while the speech processor is disabled, press the **[PROC]** button until the “**MICEQ**” icon appears in the display. To adjust the Parametric Microphone Equalizer with the speech processor engaged, press the **[PROC]** button until the “**MICEQ**” and “**PROC**” icons appear in the display.
 4. Press the **[MONI]** button, if you want to listen on the **FT-950**’s internal monitor.
 5. Press the **[MENU]** button momentarily. The Menu list will appear in the display.
 6. Rotate the **[SELECT]** knob to find the “EQ” Menu area, containing Menu items “091” through “099”; these parameters apply to the adjustment of the Parametric Microphone Equalizer when the speech processor is disabled. Menu items “100” through “108” apply to the adjustment of the Parametric Microphone Equalizer when the speech processor is engaged.

ADVICE:

If you do not find the Menu item number, press the **[SELECT]** knob momentarily to switch the Menu item name to the Menu item number.

7. Rotate the **[CLAR/VFO-B]** knob to perform adjustments to a particular Menu item.

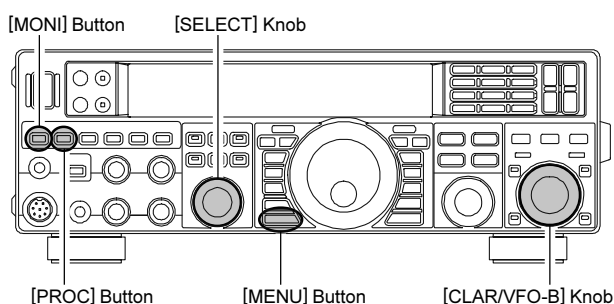

8. Close the **PTT** switch, and speak into the microphone while listening to the effect of the changes you are making. Because the overall effect on the sound will change with each adjustment, you should make several passes through each adjustment area, to be sure that you are achieving the optimum settings.
9. When you have completed all adjustments, press and hold in the **[MENU]** button for one second to save the new settings and exit to normal operation. If you only press the **[MENU]** button momentarily to exit, none of the changes you performed will be stored.

ADVICE:

To roll off excessive bass response in a wide-range studio microphone, try putting a 10 dB null at 100 Hz with a bandwidth of “1” or “2,” do about a 3 dB null centered on 800 Hz with a bandwidth of “3,” and then put an 8 dB peak centered on 2100 Hz with a bandwidth of “1.” These are starting recommendations; each microphone and user’s voice will be different, often requiring different settings.

ENHANCING TRANSMIT SIGNAL QUALITY

PARAMETRIC MICROPHONE EQUALIZER (SSB/AM/FM MODE)

Activating the Parametric Microphone Equalizer

1. Adjust the **[MIC GAIN]** knob, as described on page 56.
2. Press the **[PROC]** button momentarily. The “**MICEQ**” icon will appear in the display, confirming that the Parametric Microphone Equalizer is engaged.

ADVICE:

A blinking “**MICEQ**” icon indicates the Parametric Microphone Equalizer menu settings have all been set to “OFF” (“091 TAUD EQ1 FRQ”, “094 TAUD EQ2 FRQ”, “097 TAUD EQ3 FRQ”).

3. Press the PTT switch on the microphone, and speak into the microphone in a normal voice level.
4. To switch the Parametric Microphone Equalizer off, press the **[PROC]** button repeatedly until the “**MICEQ**” icon disappears.

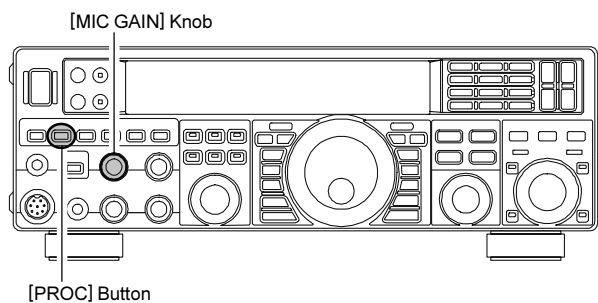

3-STAGE PARAMETRIC EQUALIZER ADJUSTMENTS (SPEECH PROCESSOR: “OFF”)

| | | |
|------------------|---------------------|--------------------------------|
| Center Frequency | “091 tAUd EQ1-FREQ” | “100” (Hz) ~ “700” (Hz) |
| | “094 tAUd EQ2-FREQ” | “700” (Hz) ~ “1500” (Hz) |
| | “097 tAUd EQ3-FREQ” | “1500” (Hz) ~ “3200” (Hz) |
| Parametric Gain | “092 AUd EQ1-LVL” | (Low) “-20” (dB) ~ “+10” (dB) |
| | “095 tAUd EQ2-LVL” | (Mid) “-20” (dB) ~ “+10” (dB) |
| | “098 tAUd EQ3-LVL” | (High) “-20” (dB) ~ “+10” (dB) |
| Q (Bandwidth) | “093 tAUd EQ1-BW” | (Low) “1” ~ “10” |
| | “096 tAUd EQ2-BW” | (Mid) “1” ~ “10” |
| | “099 tAUd EQ3-BW” | (High) “1” ~ “10” |

3-STAGE PARAMETRIC EQUALIZER ADJUSTMENTS (SPEECH PROCESSOR: “ON”)

| | | |
|------------------|---------------------|--------------------------------|
| Center Frequency | “100 tAUd PE1-FREQ” | “100” (Hz) ~ “700” (Hz) |
| | “103 tAUd PE2-FREQ” | “700” (Hz) ~ “1500” (Hz) |
| | “106 tAUd PE3-FREQ” | “1500” (Hz) ~ “3200” (Hz) |
| Parametric Gain | “101 AUd PE1-LVL” | (Low) “-20” (dB) ~ “+10” (dB) |
| | “104 tAUd PE2-LVL” | (Mid) “-20” (dB) ~ “+10” (dB) |
| | “107 tAUd PE3-LVL” | (High) “-20” (dB) ~ “+10” (dB) |
| Q (Bandwidth) | “102 tAUd PE1-BW” | (Low) “1” ~ “10” |
| | “105 tAUd PE2-BW” | (Mid) “1” ~ “10” |
| | “108 tAUd PE3-BW” | (High) “1” ~ “10” |

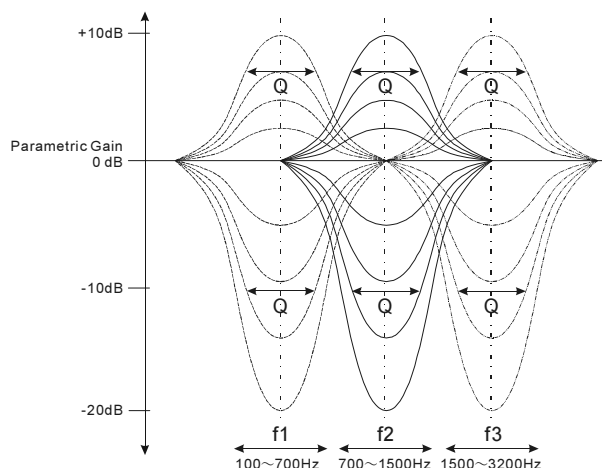

ENHANCING TRANSMIT SIGNAL QUALITY

USING THE SPEECH PROCESSOR (SSB MODE)

The **FT-950**'s Speech Processor is designed to increase "talk power" by increasing the average power output, (via a sophisticated compression technique) and adjusting the audio quality to the menu settings ("100 TAUD PE1 FRQ", "103 TAUD PE2 FRQ", "106 TAUD PE3 FRQ". The result is improved intelligibility when conditions are difficult.

1. Adjust the **[MIC GAIN]** knob, as described on page 56.
2. Press the **[METER]** button repeatedly to select "COMP" (Compression) meter.
3. Press the **[PROC]** button repeatedly until the "**MICEQ**" and "**PROC**" icons appear in the display, confirming that the Speech Processor is engaged.

ADVICE:

Blinking "**MICEQ**" and "**PROC**" icons indicate the Parametric Microphone Equalizer menu settings have all been set to "OFF" ("100 TAUD PE1 FRQ", "103 TAUD PE2 FRQ", "106 TAUD PE3 FRQ").

4. Press the **PTT** switch on the microphone, and speak into the microphone in a normal voice level. Confirm that the compression level is within the 5 dB to 10 dB range.

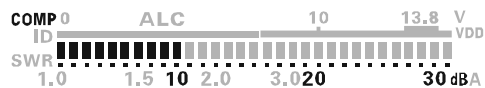

5. To switch the Speech Processor off, press the **[PROC]** button once more. The "**MICEQ**" and "**PROC**" icons will turn off, confirming that the Speech processor is turned off.

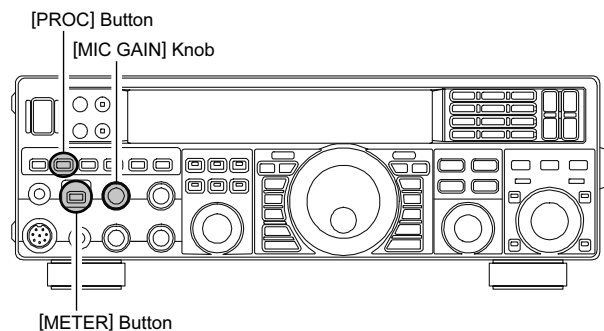

ADVICE:

- You may set the RF power output via the Menu item "111 TGEN TX PWR", whether or not the Speech Processor is engaged.
- You may adjust the Parametric Microphone Equalizer when the speech processor is engaged, using Menu Items "100" through "108". See page 117 for details.
- When the optional **DMU-2000** Data Management Unit is connected, you may observe the effect of your compression level adjustments by viewing the waveform on the "Oscilloscope" page.

Adjusting the compression level of the Speech Processor

You may adjust the compression level of the Speech Processor via the Menu Item "109 TGEN PROCLVL".

1. Press the **[METER]** button repeatedly to select "COMP" (Compression) meter.
2. Press the **[MENU]** button to engage the Menu.
3. Rotate the **[SELECT]** knob to select Menu item "109 TGEN PROCLVL".

ADVICE:

Press the **[SELECT]** knob to toggle the Menu item display between "109 TGEN" and "PROCLVL".

4. Press the **PTT** switch on the microphone, and speak into the microphone in a normal voice level. Rotate the **[CLAR/VFO-B]** knob to level "50" ~ "75".
5. Press and hold in the **[MENU]** button for one second to save the new setting and exit to normal operation.

ADVICE:

- Excessive advancement of the compression gain will result in a degradation of the transmitted signal's signal-to-noise ratio, thereby reducing intelligibility at the other end of the circuit.
- The Transmit Monitor is a very helpful way to verify proper adjustment of the compression level. Pressing the **[MONI]** button and then adjusting the **[MONI]** knob for a comfortable listening level while you are transmitting, you will be able to hear the difference in sound quality as you make adjustments.

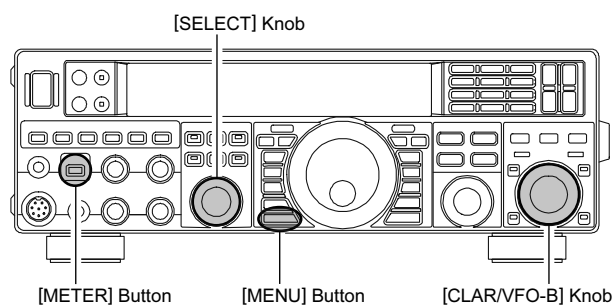

ENHANCING TRANSMIT SIGNAL QUALITY

ADJUSTING THE SSB TRANSMITTED BANDWIDTH (SSB MODE)

For transmission on SSB, a default bandwidth of 2.4 kHz is provided. This bandwidth provides reasonable fidelity along with good talk power, and is typical of the bandwidth used for decades for SSB transmission. The bandwidth may be varied by the operator, to provide different levels of fidelity or talk power, according to your preferences.

Here are the steps to adjust the SSB transmit bandwidth:

1. Press the **[MENU]** button momentarily to engage the Menu.
2. Rotate the **[SELECT]** knob to select Menu item “064 J3E TX BPF”.

ADVICE:

Press the **[SELECT]** knob to toggle the Menu item display between “064 J3E” and “TX BPF”.

3. Rotate the **[CLAR/VFO-B]** knob to select the desired bandwidth. The available selections are 1-30 (100-3000 Hz), 1-29 (100-2900 Hz), 2-28 (200-2800 Hz), 3-27 (300-2700 Hz), and 4-26 (400-2600 Hz). The default is 3-27 (300-2700 Hz). A wider bandwidth will provide greater fidelity. A narrow bandwidth will compress the available transmitter power into less spectrum, resulting in more “talk power” for DX pile-ups.
4. Press and hold in the **[MENU]** button for one second to save the new setting and exit to normal operation.

ADVICE:

- The Transmit Monitor function is a very helpful way to confirm the effect changing the bandwidth will have on fidelity. By Pressing the **[MONI]** button and then adjusting the **[MONI]** knob for a comfortable listening level while you are transmitting, you will be able to hear the difference in sound quality as you make changes.
- When the optional **DMU-2000** Data Management Unit is connected, you may verify the effect of your adjustments of the transmitted bandwidth by observing the Audio Scope on the “Oscilloscope” page.

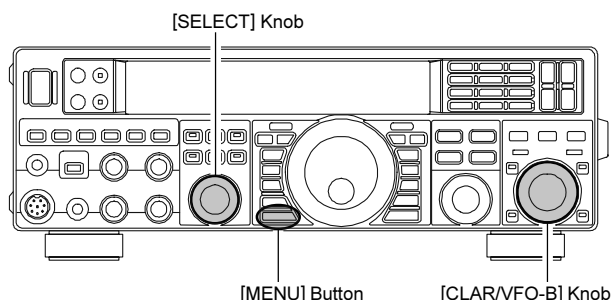

QUICK POINTS:

The higher fidelity associated with wide bandwidth will be particularly enjoyable on the low bands during local rag-chew QSOs.

TRANSMITTER CONVENIENCE FEATURES

VOICE MEMORY (SSB/AM/FM MODES: REQUIRES OPTIONAL DVS-6 VOICE MEMORY UNIT)

You may utilize the Voice Memory capability of the **FT-950** for repetitive messages. The Voice Memory system includes five memories capable of storing up to 20 seconds of voice audio each. The maximum that any memory can hold is 20 seconds.

Recording Your Own Voice in Memory

1. Select the LSB, USB, AM, or FM mode using the front panel **[MODE]** buttons.
2. Adjust the **[MIC GAIN]** knob, as described on page 56.
3. Press and hold the **[SELECT]** knob for one second to activate the Voice Memory Unit. You will see one of following indications in Multi-Display Window on the display; "rEC1", "rEC2", "rEC3", "rEC4", "rEC5", "PLY1", "PLY2", "PLY3", "PLY4", or "PLY5".
4. Rotate the **[SELECT]** knob to recall the Voice Memory Channel ("rEC1" - "rEC5") you wish to record. 
5. Press the **[SELECT]** knob momentarily. A blinking "**REC**" icon will appear in the display.
6. Press the microphone's **PTT** switch momentarily. The "**REC**" icon will glow steadily and recording will begin. If you do not press the **PTT** switch within five seconds of pressing the **[SELECT]** knob, the memory storage process will be cancelled.
7. Speak into the microphone in a normal voice level to record the message (such as "CQ DX, CQ DX, this is W 6 Delta X-Ray Charlie, W 6 Delta X-Ray Charlie, Over"). Remember that the time limit for recording any message is 20 seconds.
8. Press the **[SELECT]** knob momentarily to terminate the message storage process.

Checking Your Recording

1. Be sure that the front panel **[MOX]**, **[VOX]**, and **[BK-IN]** button are "Off" (the LED imbedded in the switch must be off.)
2. Press and hold the **[SELECT]** knob for one second to activate the Voice Memory Unit. You will see one of following indications in Multi-Display Window on the display; "rEC1", "rEC2", "rEC3", "rEC4", "rEC5", "PLY1", "PLY2", "PLY3", "PLY4", or "PLY5".
3. Rotate the **[SELECT]** knob to recall the Voice Memory Channel ("PLY1" - "PLY5") which ever one you just recorded in. 
4. Press the **[SELECT]** knob. The "**PLAY**" icon will appear in the display and you will hear the contents of the Voice Memory you just recorded.

ADVICE:

You may adjust the playback level of the recording via Menu item "O14 DVS RX LVL".

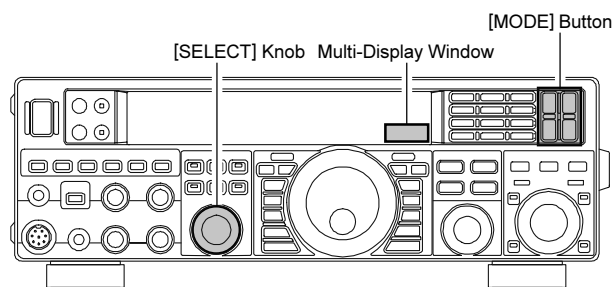

Transmitting the Recorded Message

1. Select the LSB, USB, AM, or FM mode using the front panel **[MODE]** buttons.
2. Press the front panel's **[BK-IN]** button. The "**BK-IN**" icon will appear in the display.
3. Press and hold the **[SELECT]** knob for one second to activate the Voice Memory Unit. You will see one of the following indications in the Multi-Display Window on the display; "rEC1", "rEC2", "rEC3", "rEC4", "rEC5", "PLY1", "PLY2", "PLY3", "PLY4", or "PLY5".
4. Rotate the **[SELECT]** knob to recall the Voice Memory Channel ("PLY1" - "PLY5"), depending on which memory message you wish to transmit. 
5. Press the **[SELECT]** knob. A "**PLAY**" icon will appear in the display and the message will be transmitted.

ADVICE:

You may adjust the transmit (audio) level of the recording via Menu item "O15 DVS TX LVL".

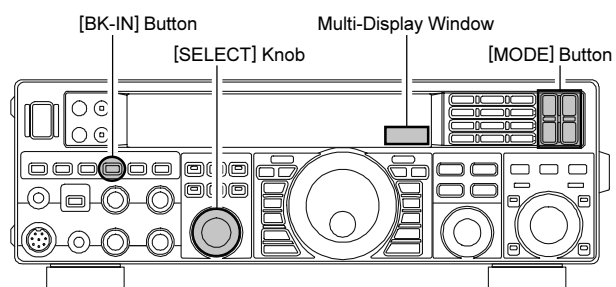
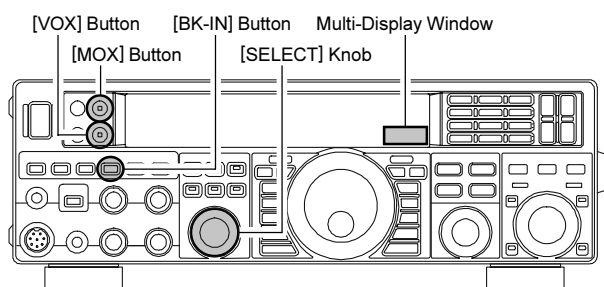

TRANSMITTER CONVENIENCE FEATURES

VOICE MEMORY (SSB/AM/FM MODES: REQUIRES OPTIONAL DVS-6 VOICE MEMORY UNIT)

Voice Memory Operation from the optional FH-2 Remote Control Keypad

You may also utilize the Voice Memory capability of the FT-950 from the optional FH-2 Remote Control Keypad, which plugs into the rear panel's **REM** jack.

Recording Your Own Voice in Memory

1. Select the LSB, USB, AM, or FM mode using the front panel **[MODE]** buttons.
2. Adjust the **[MIC GAIN]** knob, as described on page 56.
3. Press the **[MEM]** key on the **FH-2**. A blinking "**REC**" icon will appear in the display.

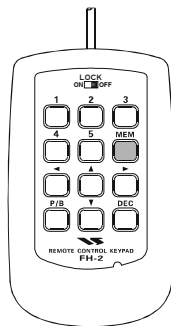

4. Press any of the **FH-2**'s keys numbered **[1]** through **[5]** to select that memory storage register.

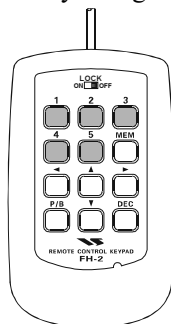

ADVICE:

If you do not press the **PTT** key (see next step) within five seconds, the memory storage process will be cancelled.

5. Press the microphone's **PTT** switch momentarily. The "**REC**" icon will glow steadily and recording will begin.
6. Speak into the microphone in a normal voice level to record the message (such as "CQ DX, CQ DX, this is W 6 Delta X-Ray Charlie, W 6 Delta X-Ray Charlie, Over"). Remember that the time limit for recording any message is 20 seconds.
7. Press the **FH-2**'s **[MEM]** key to terminate the message storage process.

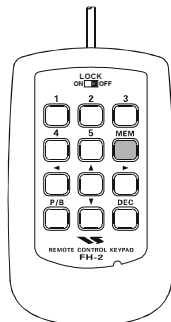

Checking Your Recording

1. Be sure that the front panel **[MOX]**, **[VOX]**, and **[BK-IN]** button are "Off" (the LED imbedded in the button must be off).
2. Press the **FH-2**'s **[1]** ~ **[5]** key (whichever one you just recorded in). The "**PLAY**" icon will appear in the display and you will hear the contents of the Voice Memory you just recorded.

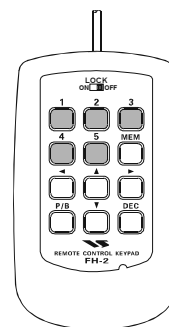

ADVICE:

You may adjust the playback level of the recording via Menu item "O14 DVS RX LVL".

Transmitting the Recorded Message

1. Select the LSB, USB, AM, or FM mode using the front panel **[MODE]** buttons.
2. Press the front panel **[BK-IN]** button. The "**BK-IN**" icon will appear in the display.
3. Press the **FH-2**'s **[1]** ~ **[5]** key (whichever one you just recorded in). A "**PLAY**" icon will appear in the display and the message will be transmitted.

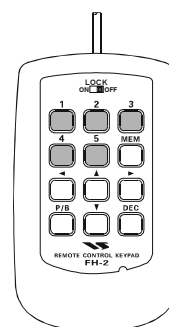

ADVICE:

You may adjust the transmit (audio) level of the recording via Menu item "O15 DVS TX LVL".

TRANSMITTER CONVENIENCE FEATURES

VOX (SSB/AM/FM MODES: AUTOMATIC TX/RX SWITCHING USING VOICE CONTROL)

Instead of using the microphone's **PTT** switch or the front panel **[MOX]** switch to activate the transmitter, the VOX (Voice Operated TX/RX Control) system provides hands-free, automatic activation of the transmitter, based on voice input into the microphone.

1. Press the **[VOX]** button to activate the VOX circuitry. The LED inside the **[VOX]** button glows red.
2. Without pressing the **PTT** switch, speak into the microphone in a normal voice level. When you start speaking, the transmitter should be activated automatically. When you finish speaking, the transceiver should return to the receive mode (after a short delay).
3. To cancel VOX and return to **PTT** operation, press the **[VOX]** button again. The LED inside the **[VOX]** button will disappear, signifying that the VOX circuitry has been turned off.

ADVICE:

- ❑ The VOX Gain may be adjusted to prevent accidental transmitter activation in a noisy environment. To adjust the VOX Gain:

- 1) Press the **[VOX]** button to activate the VOX circuitry, if necessary.
- 2) Press the **[MENU]** button momentarily to engage the Menu mode.
- 3) Rotate the **[SELECT]** knob and select Menu item "115 TGEN V GAIN".

ADVICE:

Press the **[SELECT]** knob to toggle the Menu item display between "115 TGEN" and "V GAIN".

- 4) While speaking into the microphone, rotate the **[CLAR/VFO-B]** knob to the point where the transmitter is quickly activated by your voice, without background noise causing the transmitter to activate.
 - 5) When you are satisfied with the setting, press and hold in the **[MENU]** button for one second to save the new setting and exit to normal operation.
- ❑ The "Hang-Time" of the VOX system (the transmit/receive delay after the cessation of speech) may also be adjusted via the Menu mode. The default delay is 500 msec. To set a different delay time:
- 1) Press the **[VOX]** button to activate the VOX circuitry, if necessary.
 - 2) Press the **[MENU]** button to engage the Menu.
 - 3) Rotate the **[SELECT]** knob and select Menu item "116 TGEN VOX DLY".

ADVICE:

Press the **[SELECT]** knob momentarily to toggle the Menu item display between "116 TGEN" and "VOX DLY".

- 4) Rotate the **[CLAR/VFO-B]** knob while saying a brief syllable like "Ah" and listening to the hang time for the desired delay.
- 5) When your adjustments are complete, press and hold in the **[MENU]** button for one second to save the new setting and exit to normal operation.

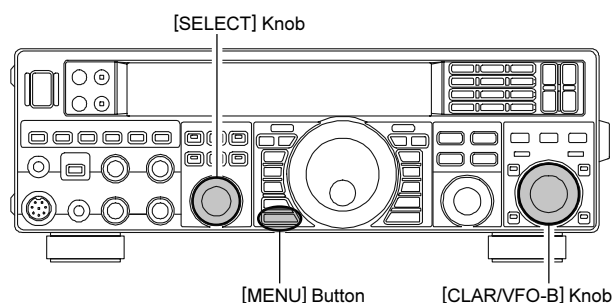
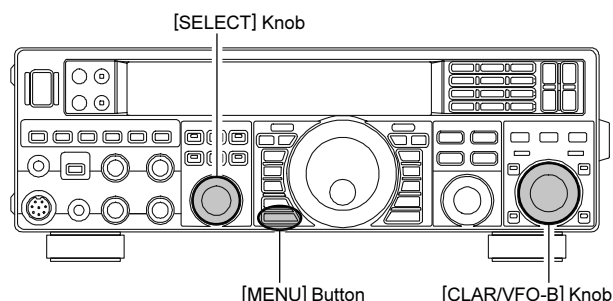
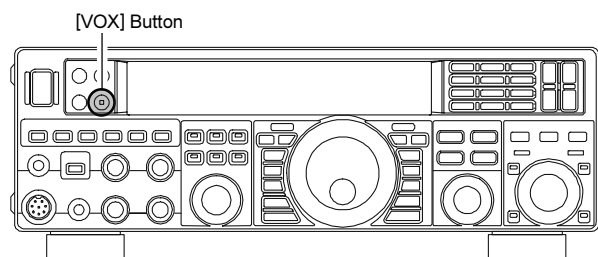

- ❑ The Anti-Trip setting adjusts the level of negative receiver audio feedback to the microphone, to prevent receiver audio from activating the transmitter (via the microphone). This setting can also be adjusted via Menu item "117 TGEN ANTIVOX".
- ❑ VOX operation may be engaged on either Voice modes (SSB/AM/FM) or on AFSK-based Data modes. Use Menu item "114 TGEN VOX SEL" (the selections are "niC (MIC)" and "dAtA (DATA)").

TRANSMITTER CONVENIENCE FEATURES

MONITOR (SSB/AM/FM MODES)

You may listen to the quality of your transmitted signal using the Monitor feature.

1. Press the **[MONI]** button. The “**MONI**” icon will appear in the display, indicating that the Monitor is turned on.
2. During transmission, rotate the **[MONI]** knob to adjust the audio level in the Headphones or speaker. Clockwise rotation of this knob will increase the volume level.
3. To switch the Monitor off again, press the **[MONI]** button once more. The “**MONI**” icon will turn off, confirming that the Monitor is now disengaged.

ADVICE:

- If you are using the speaker for monitoring, excessive advancement of the **[MONI]** knob can cause feedback to occur. This feedback can cause the VOX system to hang up in a loop, making it impossible for VOX to return to receive. Therefore, we recommend the use of headphones, if possible. If the speaker must be used, adjust the **[MONI]** knob to the minimum useable setting.
- Because the Monitor feature samples the transmitter IF signal, it can be very useful for checking the adjustment of the Speech Processor or Parametric Equalizer on SSB, and for checking the general signal quality on AM and FM.

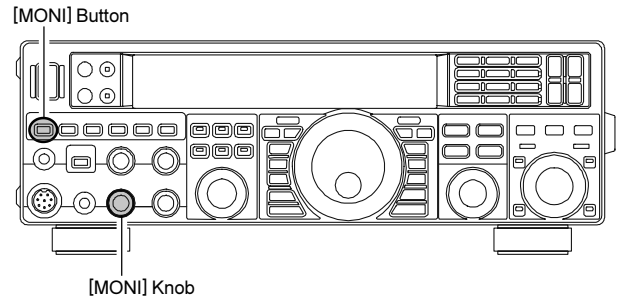

TRANSMITTER CONVENIENCE FEATURES

SPLIT OPERATION USING THE TX CLARIFIER

For split TX/RX operation in “casual” pile-ups, where the split is less than 10 kHz, the TX Clarifier (Offset Tuning) feature may be utilized.

1. Press the **[TX CLAR]** button. The “TX” icon will appear in the Multi-Display Window in the display. 

QUICK POINT:

The Clarifier is frequently used for receiver offset tuning. However, for DX pile-ups where the DX station is using a split of less than 10 kHz, the TX Clarifier function is usually the quickest way to set the transmitter to the desired offset frequency.

2. Rotate the **[CLAR/VFO-B]** knob to set the desired transmitter offset. A maximum split of ± 9.999 kHz may be set.
3. To exit from TX Clarifier operation, press the **[TX CLAR]** button once more. The “TX” icon will disappear from the Multi-Display Window.

ADVICE:

- When listening to a “pile-up” calling a DX station, in order to find the station currently being worked, you may press the **[RX CLAR]** button. Then, use the **[CLAR/VFO-B]** knob to zero in on the station calling the DX (use the SPOT function on CW for precise alignment of your frequency). You may then press the **[RX CLAR]** button again to cancel the RX Clarifier, and return to reception on the DX station’s frequency.
- Just as with receiver Clarifier operation, the amount of offset from the original VFO frequency will appear in the small display window.
- As with receiver Clarifier operation, when you turn the TX Clarifier off the last-used offset is remembered, and will be available if you turn the TX Clarifier back on. To clear the Clarifier offset, press  the **[CLEAR]** button.

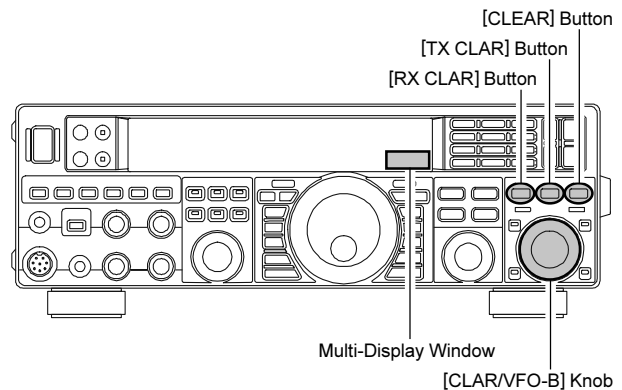

- When you operate on the VFO-B frequency, you may also activate the Clarifier on the VFO-B frequency. However, the offset frequency is set using the Main Tuning Dial knob, instead of the **[CLAR/VFO-B]** knob.
- The Clarifier operation (including the offset frequency) will be memorized independently on each VFO stack of the VFO-A and VFO-B.

QUICK POINT:

When attempting to work a DX station on CW in a split frequency pile-up, remember that a large number of other stations may also be using Yaesu transceivers with capability similar to that of your **FT-950**. On the DX side of the pile-up, everyone calling precisely on the same CW frequency will sound like a single tone! So you may have more success if you use the RX Clarifier to find a *hole* in the pile-up, instead of trying to zero-beat the last station worked by the DX station.

Clarifier Offset Bar Indicator

A visual depiction of the relative offset of the Clarifier may be displayed, using the Bar Indicator.

1. Press the **[MENU]** button to engage the Menu mode.
2. Rotate the **[SELECT]** knob to select Menu item “006 DISP BAR SEL”.

ADVICE:

Press the **[SELECT]** knob momentarily to toggle the Menu item display between “006 DISP” and “BAR SEL”.

3. Rotate the **[CLAR/VFO-B]** knob to select “CLAR” from the available choices; the factory default is “C-tn”.
4. Press and hold in the **[MENU]** button for one second to save the new setting and exit to normal operation.

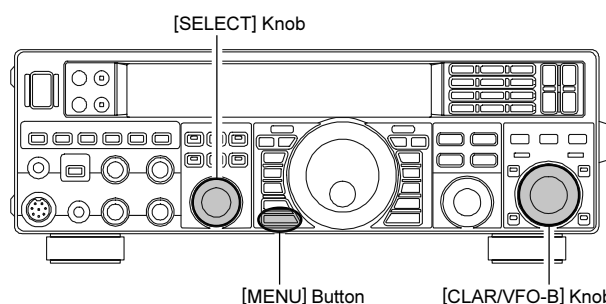
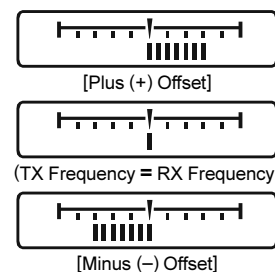

TRANSMITTER CONVENIENCE FEATURES

SPLIT-FREQUENCY OPERATION

A powerful capability of the **FT-950** is its flexibility in Split Frequency operation using the VFO-A and VFO-B frequency registers. This makes the **FT-950** especially useful for high-level DX-peditions. The Split operation capability is very advanced and easy to use.

1. Press the **[VFO-B(RX)]** Indicator/Switch, then rotate the **[CLAR/VFO-B]** knob to set the desired VFO-B frequency.
2. Press the **[VFO-A(RX)]** Indicator/Switch, then rotate the Main Tuning Dial knob to set the desired VFO-A frequency.
3. Now press the **[SPLIT]** button. The front panel Indicator/Switch LEDs will look like this:
[VFO-A(RX)] Indicator/Switch: “ON” (LED glows Green)
[VFO-A(TX)] Indicator/Switch: “OFF” (LED Off)
[VFO-B(RX)] Indicator/Switch: “OFF” (LED Off)
[VFO-B(TX)] Indicator/Switch: “ON” (LED glows Red)

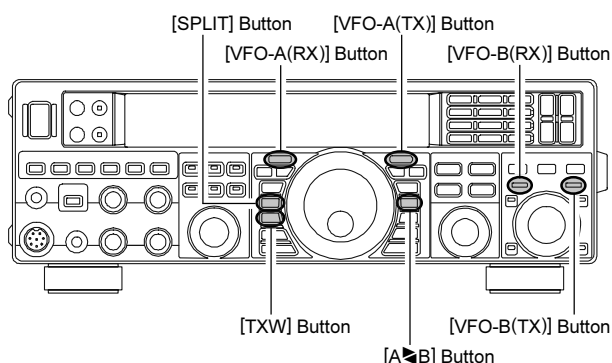

During Split operation, the VFO-A register will be used for reception, while the VFO-B register will be used for transmission. If you press the **[SPLIT]** button once more, Split operation will be cancelled.

You may also press the **[VFO-A(TX)]** Indicator/Switch to return transmit frequency control to the VFO-A register, thereby canceling Split operation.

ADVICE:

- During normal (non-split) VFO-A operation, you may simply press the **[VFO-B(TX)]** Indicator/Switch (located on the upper right of the **[CLAR/VFO-B]** knob) to engage Split operation. The **[VFO-B(TX)]** Indicator/Switch will glow Red when you press the **[VFO-B(TX)]** Indicator/Switch.
- During Split operation, pressing the **[A↔B]** button will reverse the contents of the VFO-A and VFO-B. Press the **[A↔B]** button once more to return to the original frequency alignment.
- During Split operation you may listen to the TX frequency temporarily while pressing the **[TXW]** button located on the bottom left of the Main Tuning Dial knob.
- It is possible to set different operating modes (for example, LSB and USB) on the two VFOs used during Split operation.
- During Split operation it is also possible to set the VFO-A and VFO-B to different Amateur bands if you use a multi band antenna.

Quick Split Operation

The Quick Split feature allows you to set a one-touch offset of +5 kHz to be applied to your radio's VFO-B (transmit) frequency, compared to the VFO-A frequency.

1. Start with regular transceiver operation on the VFO-A.
[VFO-A(RX)] Indicator/Switch: “ON” (LED glows Green)
[VFO-A(TX)] Indicator/Switch: “ON” (LED glows Red)
[VFO-B(RX)] Indicator/Switch: “OFF” (LED Off)
[VFO-B(TX)] Indicator/Switch: “OFF” (LED Off)
2. Press and hold in the **[SPLIT]** button for one second to engage the Quick Split feature, and apply a frequency 5 kHz above the VFO-A frequency to the VFO-B frequency register.

The VFO configuration will then be:

- [VFO-A(RX)]** Indicator/Switch: “ON” (LED glows Green)
 - [VFO-A(TX)]** Indicator/Switch: “OFF” (LED Off)
 - [VFO-B(RX)]** Indicator/Switch: “OFF” (LED Off)
 - [VFO-B(TX)]** Indicator/Switch: “ON” (LED glows Red)
3. Press and hold in the **[SPLIT]** switch for two seconds to increment the Sub (VFO-B) frequency another +5 kHz.

QUICK POINTS:

- The operating mode applied to the VFO-B register will be the same as that in use on the VFO-A register.
- The offset of VFO-B from the VFO-A is programmed via the Menu and is set to +5 kHz at the factory. However, other offsets may be selected using the following procedure:

1. Press the **[MENU]** button to engage the Menu mode.
2. Rotate the **[SELECT]** knob to select Menu item “O30 GENE Q SPLIT”.

ADVICE:

Press the **[SELECT]** knob momentarily to toggle the Menu item display between “O30 GENE” and “Q SPLIT”.

3. Rotate the **[CLAR/VFO-B]** knob to select the desired offset. The available selections are -20kHz ~ +20kHz (factory default: +5 kHz).
4. Press and hold in the **[MENU]** button for one second to save the new setting and exit to normal operation.

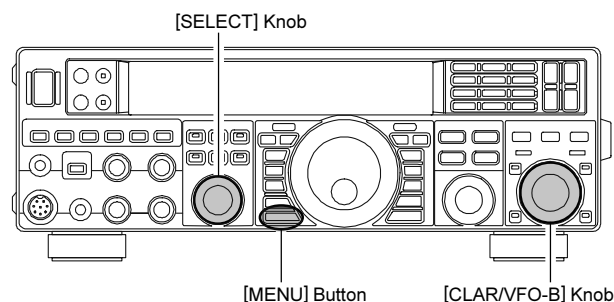

CW MODE OPERATION

The powerful CW operating capabilities of the **FT-950** permit operation using an electronic keyer paddle, a “straight key”, or a computer-based keying device.

SETUP FOR STRAIGHT KEY (AND STRAIGHT KEY EMULATION) OPERATION

Before starting, connect your key line(s) to the front and/or rear panel **KEY** jack(s). Be sure the **[KEYER]** button on the left side of the front panel is turned off for now.

1. Press the **[CW]** mode button to engage CW operation. The “**CW**” and “**USB**” icons will appear in the display. The “**MONI**” icon will also appear in the display; and the CW monitor is activated.

ADVICE:

If you press the **[CW]** button repeatedly, you will engage the “CW Reverse” mode (see page 75), whereby the “opposite” sideband injection is used, compared to the “normal” sideband. The “**CW**” and “**LSB**” icons will appear in the display if you select CW Reverse.

2. Rotate the Main Tuning Dial knob to select the desired operating frequency.
3. Press the **[BK-IN]** button to engage automatic activation of the transmitter when you close the CW key. The “**BK-IN**” icon will appear in the display.

ADVICE:

- When you close your CW key, the transmitter will automatically be activated, and the CW carrier will be transmitted. When you release the key, transmission will cease, and after a brief delay, receive will be restored. The delay time is user-programmable per the discussion on page 76.
 - As shipped from the factory, the **FT-950** TX/RX system for CW is configured for “Semi-break-in” operation. However, using Menu item “043 A1A BK-IN”, you may change this setup for full break-in (QSK) operation, whereby the switching is quick enough to hear incoming signals in the spaces between the dots and dashes of your transmission. This may prove very useful during contest and traffic handling operations.
4. Operation using your CW key may now proceed.

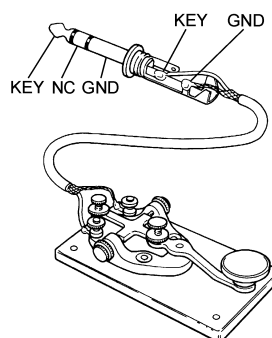
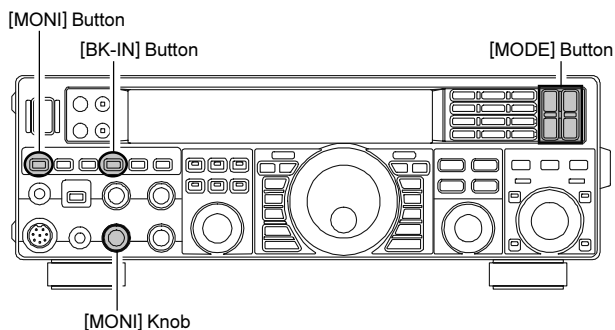

ADVICE:

- You may adjust the CW sidetone audio level with the **[MONI]** knob. Rotate the **[MONI]** knob for a comfortable listening level of the CW sidetone. To disable the CW monitor, press the **[MONI]** button (the “**MONI**” icon will disappear).
- If you set the **[BK-IN]** button to Off, you may practice sending CW with the sidetone only, without having the signal go out over the air.
- If you reduce power via the Menu item “111 TGEN TX PWR”, the ALC meter reading will increase; this is normal and does not indicate any problem whatsoever (because increased ALC voltage is being used to lower the power).

TERMINOLOGY:

Semi-break-in

This is a pseudo-“VOX” mode used on CW, whereby the closure of the CW key will engage the transmitter, and release of the key will allow the receiver to recover after a short delay. No signals will be heard during the spaces between dots and dashes (unless the sending speed is extremely slow).

Full break-in

Full break-in (also known as “Full QSK”) involves very fast switching between transmit and receive, incoming signals may be heard between the dots and dashes as you send them. This allows you to hear a station that suddenly starts transmitting on your frequency, while you are in the midst of a transmission.

USING THE BUILT-IN ELECTRONIC KEYS

Connect the cable from your keyer paddle to the front or rear panel **KEY** jack.

1. Press the **[CW]** mode button to engage CW operation. The “**CW**” and “**USB**” icons will appear in the display. The “**MONI**” icon will also appear in the display; to indicate the CW monitor is activated.

ADVICE:

If you press the **[CW]** button repeatedly, after initially selecting CW, you will engage the “CW Reverse” mode (see page 75), whereby the “opposite” sideband injection is used, compared to the “normal” sideband. The “**CW**” and “**LSB**” icons will appear in the display if you select CW Reverse.

2. Rotate the Main Tuning Dial knob to select the desired operating frequency.
3. Press the **[KEYER]** button. The “**KEYER**” icon will appear in the display, confirming that the built-in Electronic Keyer is now active.
4. Rotate the **[SPEED]** knob to set the desired sending speed (4 ~ 60 WPM). Clockwise rotation of the **[SPEED]** knob will increase the keying speed.

ADVICE:

- The frequency display will show the keying speed for 3 seconds whenever the **[SPEED]** knob is turned.
 - When you press either the “Dot” or “Dash” side of your paddle, the CW keying tone will automatically be generated.
5. Press the **[BK-IN]** button to engage automatic activation of the transmitter when you press either the “Dot” or “Dash” side of your paddle. The “**BK-IN**” icon will appear in the display.
 6. CW operation utilizing your paddle may now commence.

ADVICE:

When you utilize your keyer paddle, the transmitter will automatically be activated, and the CW characters (or a string of dots and dashes) will be transmitted. When you release the keyer paddle contacts, transmission will cease, and reception will be restored after a brief delay. The delay time is user-programmable, per the discussion on page 76.

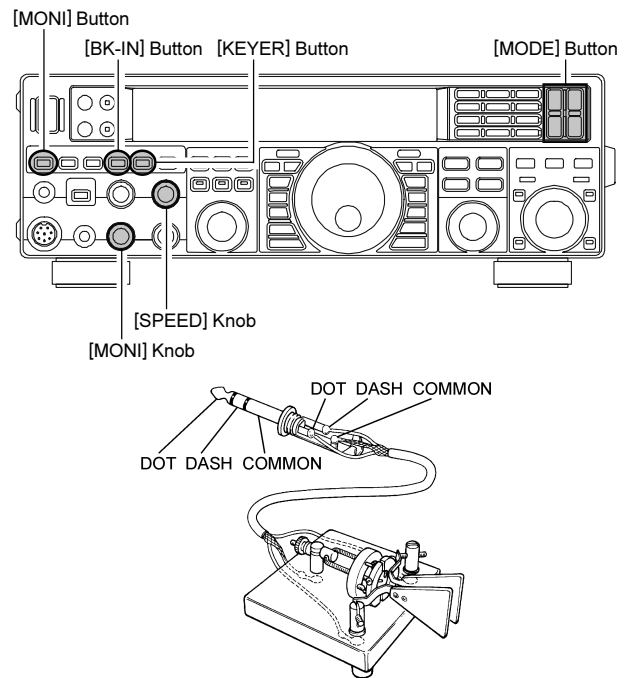

ADVICE:

- You may adjust the CW sidetone level with the **[MONI]** knob. Rotate the **[MONI]** knob for a comfortable listening level of the CW sidetone. To disable the CW monitor, press the **[MONI]** button (the “**MONI**” icon will disappear).
- If you set the **[BK-IN]** button to Off, you may practice sending CW with the sidetone only, without having the signal go out over the air.
- If you reduce power via the Menu item “111 TGEN TX PWR”, the ALC meter reading will increase. This is normal and does not indicate any problem whatsoever (because increased ALC voltage is being used to lower the power).

CW MODE OPERATION

USING THE BUILT-IN ELECTRONIC KEYS

Full Break-in (QSK) Operation

As shipped from the factory, the **FT-950** TX/RX system for CW is configured for “Semi-break-in” operation. However, using Menu item “043 A1A BK-IN,” you may change this setup for full break-in (QSK) operation, whereby the switching is quick enough to hear incoming signals in the spaces between the dots and dashes of your transmission.

1. Press the **[MENU]** button to engage the Menu.
2. Rotate the **[SELECT]** knob to select Menu item “043 A1A BK-IN”.

ADVICE:

Press the **[SELECT]** knob momentarily to toggle the Menu item display between “043 A1A” and “BK-IN”.

3. Rotate the **[CLAR/VFO-B]** knob to set this Menu item to “FULL”.
4. When your adjustments are complete, press and hold in the **[MENU]** button for one second to save the new setting and exit to normal operation.

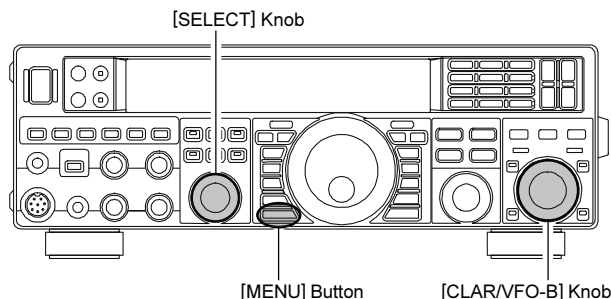

A number of interesting and useful features are available during Electronic Keyer operation.

Setting the Keyer Weight (Dot/Dash) Ratio

This Menu item may be used to adjust the dot/dash ratio for the built-in Electronic Keyer. The default weighting is 3:1 (a dash is three times longer than a dot).

1. Press the **[MENU]** button to enter the Menu mode.
2. Rotate the **[SELECT]** knob to select Menu item “046 A1A WEIGHT”.

ADVICE:

Press the **[SELECT]** knob momentarily to toggle the Menu item display between “046 A1A” and “WEIGHT”.

3. Rotate the **[CLAR/VFO-B]** knob to set the weight to the desired value. The available adjustment range is for a Dot/Dash ratio of 2.5 ~ 4.5 (default value: 3.0).
4. When you are finished, press and hold in the **[MENU]** button for one second to save the new setting and exit to normal operation.

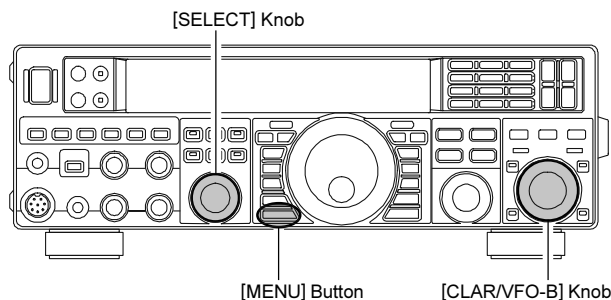

USING THE BUILT-IN ELECTRONIC KEYS

Selecting the Keyer Operating Mode

The configuration of the Electronic Keyer may be customized independently for the front **KEY** jacks of the **FT-950**. This permits utilization of Automatic Character Spacing (ACS), if desired. This permits the use of an electronic keyer via the front jack and a straight key or computer-driven keying line via the rear panel jack.

1. Press the **[MENU]** button to enter the Menu mode.
2. Rotate the **[SELECT]** knob to select Menu item "037 A1A F-TYPE" (for the front **KEY** jack) or "039 A1A R-TYPE" (for the rear-panel **KEY** jack).

ADVICE:

Press the **[SELECT]** knob momentarily to toggle the Menu item display between "037 A1A" and "F-TYPE" or "039 A1A" and "R-TYPE".

3. Rotate the **[CLAR/VFO-B]** knob to set the keyer to the desired mode. The available selections are:
 - OFF: The built-in Electronic Keyer is turned off ("straight key" mode).
 - buG: Dots will be generated automatically by the keyer, but dashes must be sent manually.
 - ELE: Both dots and dashes will be generated automatically when you use your paddle.
 - ACS: Same as "ELE" except that the spacing between characters is precisely set by the keyer to be the same length as a dash (three dots in length)
4. When you are finished, press and hold in the **[MENU]** button for one second to save the new setting and exit to normal operation.

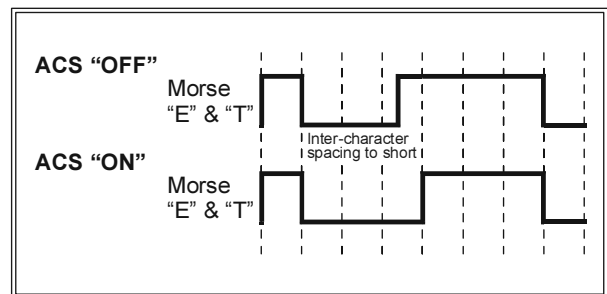
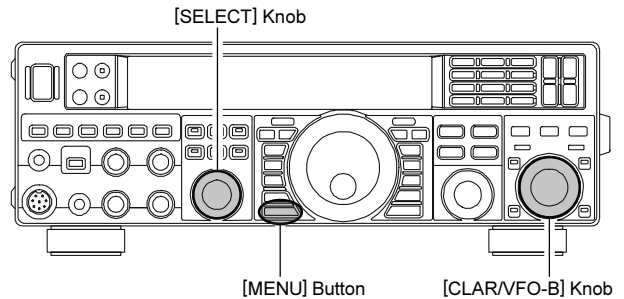

CW CONVENIENCE FEATURES

AUDIO PEAK FILTER

1. Press the **[CONT]** button to disable the Contour filter, if necessary. The Contour indicator disappears from the CONTOUR indication on the display.

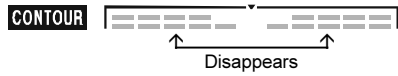

2. Press and hold the **[CONT]** button for 2 seconds to activate the APF (Audio Peak Filter) which provides a very narrow audio bandwidth.

ADVICE:

When APF is engaged, the peak position of the APF is depicted graphically in the CONTOUR indicator (but, “**CONTOUR**” icon does not appear).

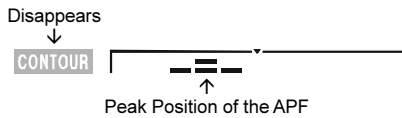

3. Press the **[CONT]** button to disable the APF, and then press the **[CONT]** button again to activate the Contour filter, if desired.

ADVICE:

The APF may only be activated while the transceiver is in CW mode.

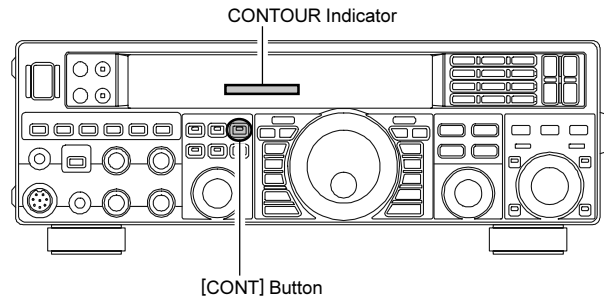

CW CONVENIENCE FEATURES

CW SPOTTING (ZERO-BEATING)

“Spotting” (zeroing in on another CW station) is a handy technique to ensure you and the other station are precisely on the same frequency.

The Tuning Offset Indicator in the display may also be moved so you can adjust your receiver frequency to center the incoming station on the pitch corresponding to that of your transmitted signal.

Using the SPOT System

While pressing the front panel **[SPOT]** button, the Spot tone will be heard through your speaker and the frequency display will show the Spot tone frequency. This tone corresponds to the pitch of your transmitted signal. If you adjust the receiver frequency until the pitch of the received CW signal matches that of the Spot tone, your transmitted signal will be precisely matched to that of the other station.

Release the **[SPOT]** button to turn the Spot tone off.

ADVICE:

- ❑ In a tough DX pile-up, you may actually want to use the SPOT system to find a “gap” in the spread of calling stations, instead of zeroing in precisely on the last station being worked by the DX station. From the DX side, if a dozen or more operators (also using Yaesu’s SPOT system) all call precisely on the same frequency, their dots and dashes merge into a single, long tone that the DX station cannot decipher. In such situations, calling slightly higher or lower in frequency may get your call through.
- ❑ The Tuning Offset Indicator in the display may be utilized for CW frequency adjustment, as well. Its configuration is set via Menu item “006 DISP BAR SEL” at the factory, and the Tuning Offset Indicator is already set to the “C-tr” selection.

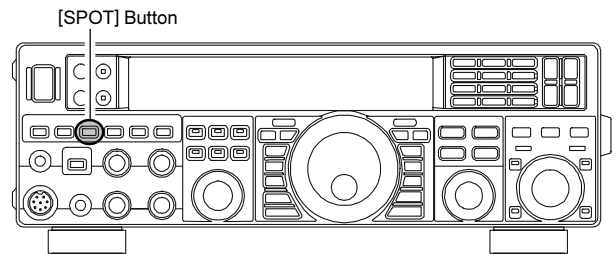

QUICK POINTS:

- ❑ The CW Spotting process utilizes the Spot tone or the Tuning Offset Indicator. The actual offset pitch is set by Menu item “045 A1A PITCH” (see page 112). The offset pitch may be set to any frequency between 300 Hz and 1050 Hz, in 50 Hz steps. You can either match tones audibly (using the **[SPOT]** button) or tune the receiver frequency so that the central red LED on the Tuning Offset indicator lights up. Note that there are 21 “dots” on the Tuning Offset Indicator, and depending on the resolution selected, the incoming CW signal may fall outside the visible range of the bar indicator, if you are not reasonably close to the proper alignment of tones.
- ❑ The displayed frequency on CW normally reflects the “zero beat” frequency of your offset carrier. That is, if you were to listen on USB on 14.100.00 MHz to a signal with a 700 Hz offset, the “zero beat” frequency of that CW carrier would be 14.000.70 MHz; the latter frequency is what the **FT-950** displays, by default. However, you can change the display to be identical to what you would see on SSB by using Menu item “047 A1A FRQDISP” and setting it to “dlr” instead of the default “OFSt” setting.

CW CONVENIENCE FEATURES

USING CW REVERSE

If you experience a difficult interference situation, where an interfering station cannot readily be eliminated, you may wish to try receiving using the opposite sideband. This may move the interfering station's frequency in a direction that may lend itself more readily to rejection.

1. To start, let's use a typical example where you have set the CW mode (using the default "USB" injection).
2. Now be sure your mode selection is still set for VFO-A, and then press the [CW] mode button once more. The "CW" and "LSB" icons will appear in the display, indicating that the "LSB" injection side has now been selected.
3. To return to the normal (USB) injection side and cancel CW Reverse operation, press the [CW] mode button once more. (the "CW" and "USB" icons will appear in the display).

NOTES:

- When CW Reverse is engaged, the action of the Tuning Offset Indicator will also be reversed
- When the incoming signal pitch tone is properly aligned, the central red marker lights up whether or not CW Reverse is engaged.

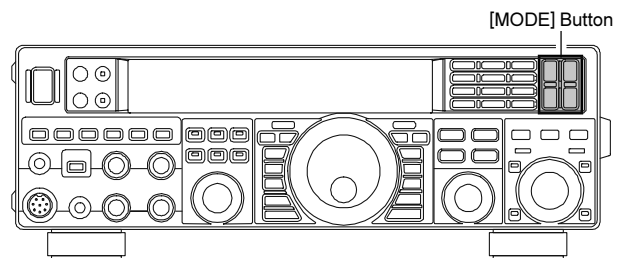
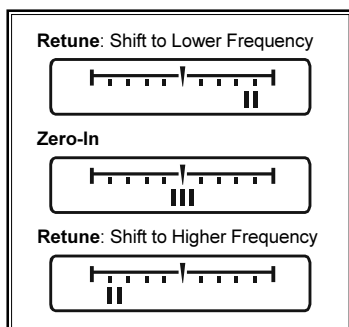

In the illustration, Figure "A" demonstrates the normal CW injection setup, using the USB side. In Figure "B", CW Reverse has been engaged, to receive using LSB-side injection and eliminate interference.

The beneficial effect of switching sidebands can be clearly seen in this example.

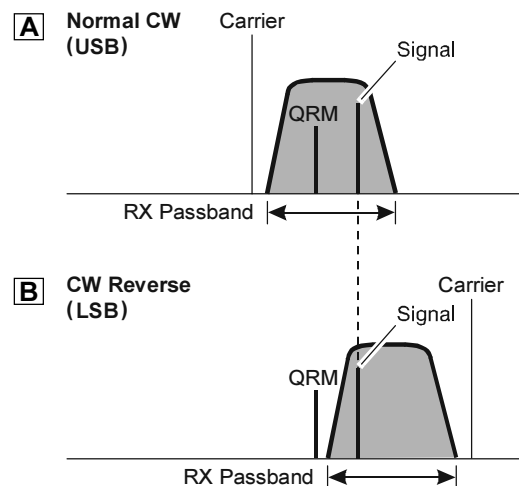

CW CONVENIENCE FEATURES

CW DELAY TIME SETTING

During semi-break-in (not QSK) operation, the hang time of the transmitter, after you have finished sending, may be adjusted to a comfortable value consistent with your sending speed. This is the functional equivalent of the “VOX Delay” adjustment used on voice modes, and the delay may be varied anywhere between 30 msec and 3 seconds via Menu item “044 A1A DELAY”.

1. Press the **[BK-IN]** button to enable CW transmission (Menu item “043 A1A BK-IN” must be set to “SEni”).
2. Press the **[MENU]** button to enter the Menu mode.
3. Rotate the **[SELECT]** knob to select Menu item “044 A1A DELAY”.

ADVICE:

Press the **[SELECT]** knob momentarily to toggle the Menu item display between “044 A1A” and “DELAY”.

4. Start sending and rotate the **[CLAR/VFO-B]** knob to adjust the hang time, as you prefer for comfortable operation.
5. When you are finished, press and hold in the **[MENU]** button for one second to save the new setting and exit to normal operation.

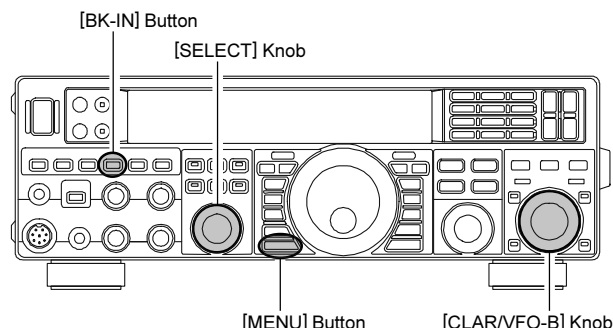

CW PITCH ADJUSTMENT

You may adjust the center frequency of the receiver passband, and change the pitch of your offset CW carrier, to the tone you prefer via the Menu item “045 A1A PITCH”. The tone may be varied between 300 Hz and 1050 Hz, in 50 Hz steps.

1. Press the **[MENU]** button to enter the Menu mode.
2. Rotate the **[SELECT]** knob to select Menu item “045 A1A PITCH”.

ADVICE:

Press the **[SELECT]** knob momentarily to toggle the Menu item display between “045 A1A” and “PITCH”.

3. Rotate the **[CLAR/VFO-B]** knob to select the desired tone.
4. When you are finished, press and hold in the **[MENU]** button for one second to save the new setting and exit to normal operation.

ADVICE:

You may confirm the Spot tone frequency by pressing the **[SPOT]** button. The frequency display will show the Spot tone frequency.

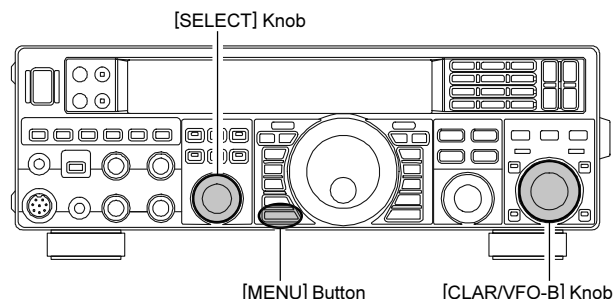

TERMINOLOGY:

CW Pitch: If you tuned to an exact “zero beat” on an incoming CW signal, you could not copy it (“Zero beat” implies a 0 Hz tone). Therefore, the receiver is offset several hundreds of Hz (typically), to allow your ear to detect the tone. The BFO offset associated with this tuning (that produces the comfortable audio tone) is called the CW Pitch.

CW CONVENIENCE FEATURES

CONTEST MEMORY KEYS

The **FT-950** is capable of automatically sending CW messages (as you might do in a contest). Two techniques for message storage are available: you may either send the desired message contents using your keyer paddle (“Message Memory”), or you may input the text characters using the Main Dial Tuning knob and [CLAR/VFO-B] knobs (“Text Memory”).

Message Memory

Five memory channels capable of retaining 50 characters each are provided (using the PARIS standard for characters and word length).

Example: CQ CQ CQ DE W6DXC K (19 characters)

--- · · · · · --- · · · · · --- · · · · · --- · · · · · --- · · · · · --- · · · · · --- · · · · · --- · · · · · --- · · · · · --- · · · · · --- · · · · ·
(C) (Q) (C) (Q) (C) (Q) (D) (E) (W) (6) (D) (X) (C) (K)

STORING A MESSAGE INTO MEMORY

1. Press the [MENU] button to enter the Menu mode.
2. Rotate the [SELECT] knob to select the CW Memory Register, into which you wish to store the message; for now, we are just selecting the message entry technique for (Keyer entry).
019 KEY CW MEM1
020 KEY CW MEM2
021 KEY CW MEM3
022 KEY CW MEM4
023 KEY CW MEM5
- ADVICE:**
Press the [SELECT] knob momentarily to toggle the Menu item display between “Menu Item Number & Group Name” and “Menu Function”.
3. Rotate the [CLAR/VFO-B] knob to set the selected CW Memory Register to “tyP2”. If you want to use your keyer paddle for message entry on all memories, set all five Menu items (#019 ~ 023) to “tyP2”.
4. Press and hold in the [MENU] button for one second to save the new settings and exit.

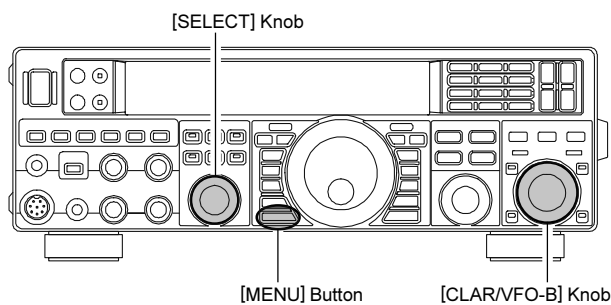

TERMINOLOGY:

PARIS Word Length: By convention in the Amateur industry (utilized by ARRL and others), the length of one “word” of CW is defined as the length of the Morse Code characters spelling the word “PARIS”. This character (dot/dash/space) length is used for the rigorous definition of code speed in “words per minute”.

MESSAGE MEMORY PROGRAMMING (USING YOUR PADDLE)

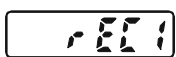
1. Press the [CW] button to set the operating mode to CW.
2. Be sure that Break-in is “Off” by pressing the [BK-IN] button.
3. Turn the internal Electronic Keyer “On” by pressing the [KEYER] button, if necessary.
4. Press and hold the [SELECT] knob for one second to activate the Contest Memory Keyer. One of following indications will appear in the Multi-Display Window on the display; “rEC1”, “rEC2”, “rEC3”, “rEC4”, “rEC5”, “PLY1”, “PLY2”, “PLY3”, “PLY4”, or “PLY5”.
5. Rotate the [SELECT] knob to select the CW Memory Register (“rEC1” through “rEC5”) that you wish to store the message in. 
6. Press the [SELECT] knob momentarily. The “REC” icon will appear in the display.
7. Send the desired message using your keyer paddle.
ADVICE:
If you do not key within ten seconds of pressing the [SELECT] knob, the memory storage process will be cancelled.
8. Press the [SELECT] knob momentarily once more at the end of your message. Up to 50 characters may be stored in each of the five memories.

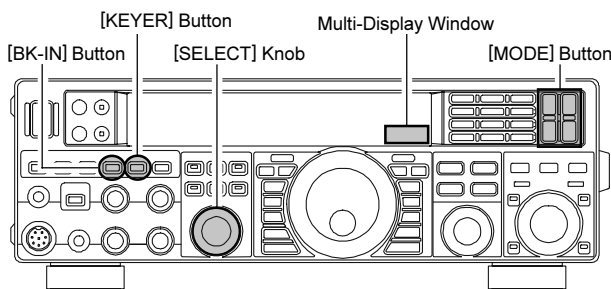

NOTE:

You must exercise care in sending to ensure that the spaces between letters and words are accurately done; if your timing is off, the spacing may not come out right in the stored message. For ease in setting up the keyer memories, we recommend you set Menu item “037 A1A F-TYPE” and/or “039 A1A R-TYPE” to “ACS” (Automatic Character Spacing) while you are programming the keyer memories.

CW CONVENIENCE FEATURES

CONTEST MEMORY KEYER

CHECKING THE CW MEMORY CONTENTS

1. Be sure that Break-in is still turned "Off" by the [BK-IN] button.
2. Press the [MONI] button to enable the CW monitor. A "MONI" icon will appear in the display.
3. Press and hold the [SELECT] knob for one second to activate the Contest Memory Keyer. You will see one of following indications in Multi-Display Window on the display; "rEC1", "rEC2", "rEC3", "rEC4", "rEC5", "PLY1", "PLY2", "PLY3", "PLY4", or "PLY5".
4. Rotate the [SELECT] knob to select the CW Memory Register ("PLY1" through "PLY5") in which you wish to check the message. 
5. Press the [SELECT] knob momentarily. You will hear the results in the sidetone monitor, but no RF energy will be transmitted.

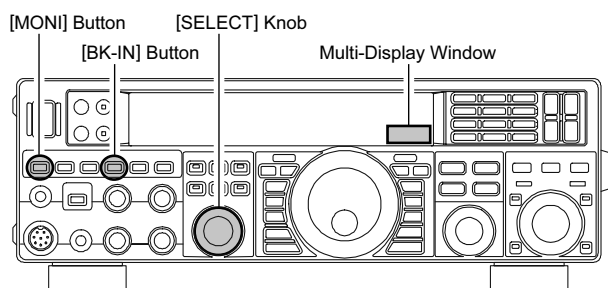

NOTE:

Adjust the sidetone monitor level using the [MONI] knob.

ON-THE-AIR CW MESSAGE PLAYBACK

1. Press the [BK-IN] button to enable transmission. Either Full- or Semi-break-in will be engaged, depending on the setting of Menu item "043 A1A BK-IN."
2. Press and hold the [SELECT] knob for one second to activate the Contest Memory Keyer. You will see one of following indications in Multi-Display Window on the display; "rEC1", "rEC2", "rEC3", "rEC4", "rEC5", "PLY1", "PLY2", "PLY3", "PLY4", or "PLY5".
3. Rotate the [SELECT] knob to select the CW Memory Register ("PLY1" through "PLY5") that you wish to transmit. 
4. Press the [SELECT] knob momentarily. The programmed message will be transmitted on the air.

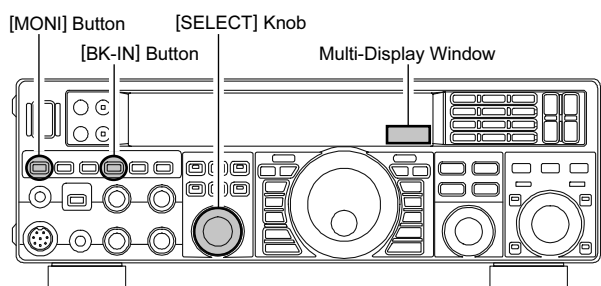

NOTE:

If you subsequently decide to use the "Text Memory" technique for memory storage, please note that the contents of a message stored using keyer paddle input will not be transferred over when you select "Text Memory technique" on a particular memory register (the Menu Mode Setting is set to "tyP1").

Transmitting in the Beacon Mode

It is possible to transmit repetitively in a "Beacon" mode, any message programmed either via paddle input or via the "Text" input method. The time delay between message repeats may be set anywhere between 1 and 690 seconds (1 ~ 240 sec (1 sec/step) or 270 ~ 690 sec (30 sec/step)) via Menu item "016 KEY BEACON". If you do not wish the message to repeat in a "Beacon" mode, please set this Menu item to "OFF".

To transmit the message:

1. Press and hold the [SELECT] knob for two seconds to activate the Contest Memory Keyer. You will see one of following indication in Multi-Display Window on the display; "rEC1", "rEC2", "rEC3", "rEC4", "rEC5", "PLY1", "PLY2", "PLY3", "PLY4", or "PLY5".
2. Rotate the [SELECT] knob to select the CW Memory Register ("PLY1" through "PLY5") where the Beacon message is stored. 
3. Press the [SELECT] knob momentarily. Repetitive transmission of the Beacon message will begin. Press the [SELECT] knob once more to halt the Beacon transmissions.

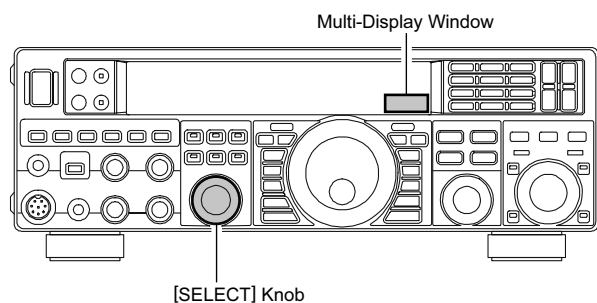

CW CONVENIENCE FEATURES

CONTEST MEMORY KEYER

TEXT Memory

The five channels of CW message memory (up to 50 characters each) may also be programmed using a text-entry technique. This technique is somewhat slower than sending the message directly from your keyer paddle, but accuracy of character spacing is ensured.

Example 1: CQ CQ CQ DE W6DXC K (20 characters)

The sequential Contest Number (“Countup”) feature is another powerful feature of the CW Memory Keyer.

Example 2: 599 10 200 # K (15 characters)

STORING A MESSAGE INTO MEMORY

1. Press the **[MENU]** button to enter the Menu mode.
2. Rotate the **[SELECT]** knob to select the CW Memory Register into which you wish to store the message; for now, we are just setting the message entry technique to (Text entry).

019 KEY CW MEM1
020 KEY CW MEM2
021 KEY CW MEM3
022 KEY CW MEM4
023 KEY CW MEM5

ADVICE:

Press the **[SELECT]** knob momentarily to toggle the Menu item display between “Menu Item Number & Group Name” and “Menu Function”.

3. Rotate the **[CLAR/VFO-B]** knob to set the selected CW Memory Register to “tyP1”. If you want to use text message entry on all memories, set all five Menu items (#019 ~ 023) to “tyP1”.
4. Press and hold in the **[MENU]** button for one second to save the new settings and exit.

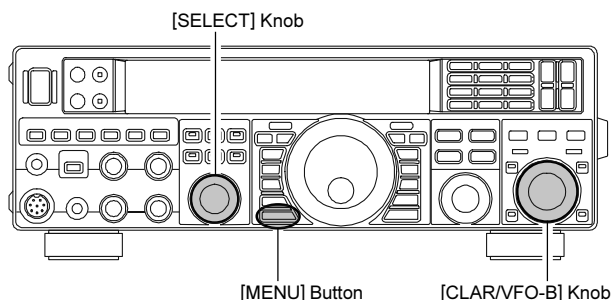

TEXT MESSAGE PROGRAMMING

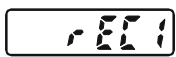
1. Press the **[CW]** button to set the operating mode to CW.
2. Be sure that the Break-in is “Off” by pressing the **[BK-IN]** button, if necessary.
3. Press and hold the **[SELECT]** knob for one second to activate the Contest Memory Keyer. You will see one of following indication in Multi-Display Window on the display; “rEC1”, “rEC2”, “rEC3”, “rEC4”, “rEC5”, “PLY1”, “PLY2”, “PLY3”, “PLY4”, or “PLY5”.
4. Rotate the **[SELECT]** knob to select the Memory Register (“rEC1” through “rEC5”), in which you wish to program the text. 
5. Press the **[SELECT]** knob momentarily.
6. Use the Main Tuning Dial knob to set the cursor position and use the **[CLAR/VFO-B]** knob to choose the letter/number to be programmed in each slot of the memory. In the case of *Example 2* above, the “#” character designates the slot where the Contest “Count up” Number will be inserted.
7. When the message is complete, add the “}” character at the end to signify the termination of the message.
8. Press and hold in the **[SELECT]** button for one second to exit, once all characters (including “}”) have been programmed.

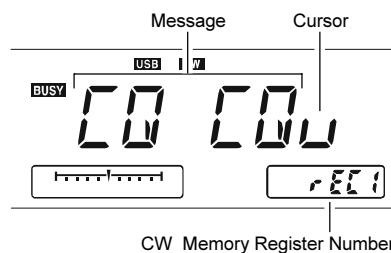
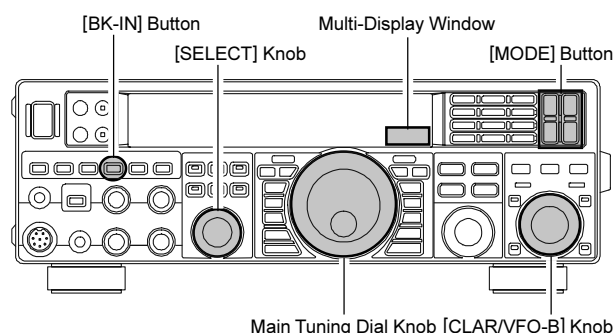

ADVICE:

Momentarily pressing the **[SELECT]** button will cancel the programming.

CW CONVENIENCE FEATURES

CONTEST MEMORY KEYS

CHECKING THE CW MEMORY CONTENTS

1. Be sure that Break-in is still turned "Off" by the [BK-IN] button.
2. Press the [MONI] button momentarily to enable CW monitor. A "MONI" icon will appear in the display.
3. Press and hold the [SELECT] knob for one second to activate the Contest Memory Keyer. You will see one of following indications in Multi-Display Window on the display; "rEC1", "rEC2", "rEC3", "rEC4", "rEC5", "PLY1", "PLY2", "PLY3", "PLY4", or "PLY5".
4. Rotate the [SELECT] knob to select the CW Memory Register ("PLY1" through "PLY5") whichever one you just recorded. 
5. Press the [SELECT] knob momentarily. You will hear the results in the sidetone monitor, but no RF energy will be transmitted.

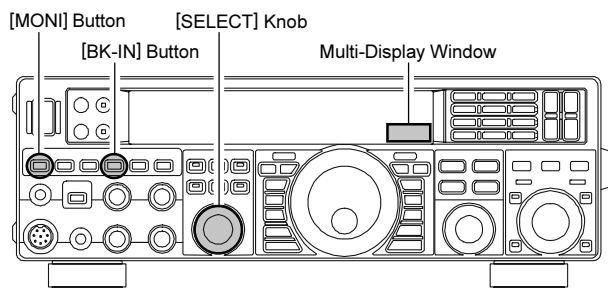

NOTE:

Adjust the monitor level using the [MONI] knob.

Deleting Previously-stored Characters

Use the Main Tuning Dial knob to select the last correct letter in the message. Now rotate the [CLAR/VFO-B] knob to select the "}" character; everything after the "}" character will be deleted.

ON-THE-AIR CW MESSAGE PLAYBACK

1. Press the [BK-IN] button to enable transmission. Either Full- or Semi-break-in will be engaged, depending on the setting of Menu item "O43 A1A BK-IN".
2. Press the [MONI] button momentarily to enable CW monitor. A "MONI" icon will appear in the display.
3. Press and hold the [SELECT] knob for one second to activate the Contest Memory Keyer. You will see one of following indications in Multi-Display Window on the display; "rEC1", "rEC2", "rEC3", "rEC4", "rEC5", "PLY1", "PLY2", "PLY3", "PLY4", or "PLY5".
4. Rotate the [SELECT] knob to select the CW Memory Register ("PLY1" through "PLY5") that you wish to transmit. 
5. Press the [SELECT] knob momentarily. The programmed message will be transmitted on the air.

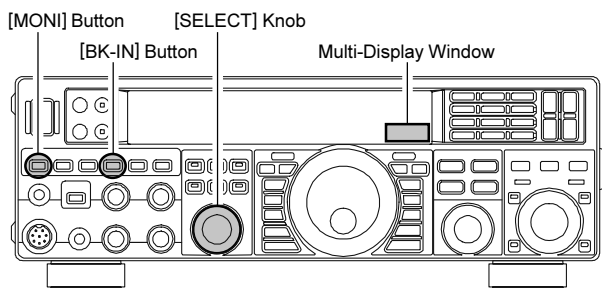

NOTE:

If you subsequently decide to use the "Message Memory" technique for memory storage, please note that the contents of a message stored using text input will not be transferred over when you select "Message Memory technique" on a particular memory register (the Menu Mode Setting is set to "tyP2").

| TEXT | DISPLAY | CW CODE | TEXT | DISPLAY | CW CODE | TEXT | DISPLAY | CW CODE | TEXT | DISPLAY | CW CODE |
|------|---------|---------|------|---------|---------|------|---------|---------|------|---------|---------|
| ! | | SN | (| | KN | / | | DN | @ | | @ |
| " | | AF |) | | KK | : | | OS | [| | - |
| # | | - | * | | - | ; | | KR | \ | | AL |
| \$ | | SX | + | | AR | < | | - |] | | - |
| % | | KA | , | | MIM | = | | BT | ^ | | - |
| & | | AS | - | | DU | > | | - | _ | | IQ |
| ' | | WG | . | | AAA | ? | | IMI | } | | - |

CW CONVENIENCE FEATURES

CONTEST MEMORY KEYER (USING THE OPTIONAL FH-2 REMOTE CONTROL KEYPAD)

You may also utilize the CW message capability of the **FT-950** from the optional **FH-2** Remote Control Keypad, which plugs into the rear panel **REM** jack.

Message Memory

Five memory channels capable of retaining 50 characters total are provided (using the PARIS standard for characters and word length).

Example: CQ CQ CQ DE W6DXC K (19 characters)

STORING A MESSAGE INTO MEMORY

1. Press the **[MENU]** button to enter the Menu mode.
2. Rotate the **[SELECT]** knob to select the CW Memory Register into which you wish to store the message; for now, we are just setting the message entry technique to (Keyer entry).

019 KEY CW MEM1
020 KEY CW MEM2
021 KEY CW MEM3
022 KEY CW MEM4
023 KEY CW MEM5

ADVICE:

Press the **[SELECT]** knob momentarily to toggle the Menu item display between “Menu Item Number & Group Name” and “Menu Function”.

3. Rotate the **[CLAR/VFO-B]** knob to set the selected CW Memory Register to “tyP2”. If you want to use your keyer paddle for message entry on all memories, set all five Menu items (#019 ~ 023) to “tyP2”.
4. Press and hold in the **[MENU]** button for one second to save the new settings and exit.

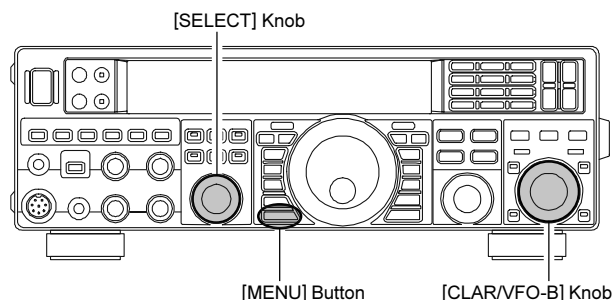

Contest Number Programming

Use this process if you are starting a contest, or if you somehow get out of sync with the proper number in the middle of a contest.

1. Press the **[MENU]** button to enter the Menu mode.
2. Rotate the **[SELECT]** knob to select Menu item “018 KEY CONTEST”. The current contest number appears in the Multi-Display Window on the display.

ADVICE:

Press the **[SELECT]** knob momentarily to toggle the Menu item display between “018 KEY” and “CONTEST”.

3. Rotate the **[CLAR/VFO-B]** knob to set the Contest Number to the desired value.

ADVICE:

Press the **[CLEAR]** button (located at the upper right of the **[SELECT]** knob) to reset the Contest Number to “1”.

4. Press and hold the **[MENU]** button for one second more to store the new number and exit.

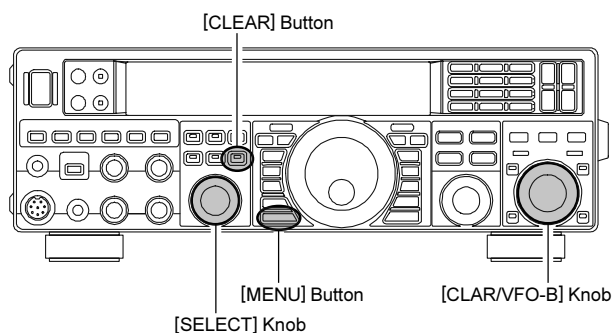

CW CONVENIENCE FEATURES

CONTEST MEMORY KEYER (USING THE OPTIONAL FH-2 REMOTE CONTROL KEYPAD)

MESSAGE MEMORY PROGRAMMING (USING YOUR PADDLE)

1. Set the operating mode to CW.
2. Set the [BK-IN] button to "Off".
3. Turn the internal Electronic Keyer "On" by pressing the [KEYER] button, if necessary.
4. Press the [MEM] key on the FH-2. A blinking "REC" icon will appear in the display.

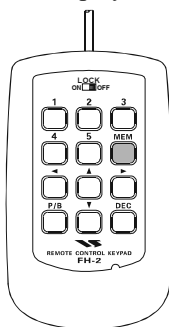

5. Press any of the FH-2's keys numbered [1] through [5] to begin the memory storage process, and the "REC" icon will glow steadily.

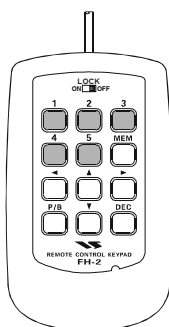

6. Send the desired message using your keyer paddle.

ADVICE:

If you do not start keying within ten seconds, the memory storage process will be cancelled.

7. Press the [MEM] key on the FH-2 once more at the end of your message. Up to 50 characters may be stored in each of the five memories.

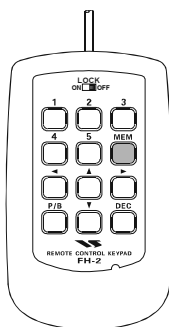

NOTE:

You must exercise care in sending to ensure that the spaces between letters and words are accurately done; if your timing is off, the spacing may not come out right in the stored message. For ease in setting up the keyer memories, we recommend you set Menu item "037 A1A F-TYPE" and/or "039 A1A R-TYPE" to "ACS" (Automatic Character Spacing) while you are programming the keyer memories.

CHECKING THE CW MEMORY CONTENTS

1. Be sure that Break-in is still turned "Off" by the [BK-IN] button.
2. Press the [MONI] button to enable the CW monitor. A "MONI" icon will appear in the display.
3. Press the FH-2's [1] ~ [5] key whichever one you just recorded in. You will hear the results in the sidetone monitor, but no RF energy will be transmitted.

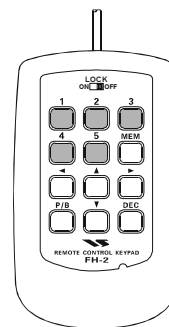

NOTE:

You may adjust the monitor level using the [MONI] knob.

ON-THE-AIR CW MESSAGE PLAYBACK

1. Press the [BK-IN] button to enable transmission. Either Full- or Semi-break-in will be engaged, depending on the setting of Menu item "043 A1A BK-IN".
2. Press the FH-2's [1] ~ [5] key, depending on which CW Memory Register's message you wish to transmit. The programmed message will be transmitted on the air.

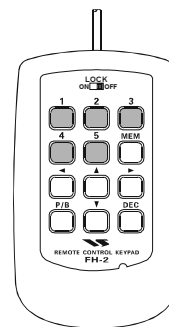

NOTE:

If you subsequently decide to use the "Text Memory" technique for memory storage, please note that a message stored using keyer paddle input will not be transferred over when you select "Text Memory technique" on a particular memory register (the Menu Mode Setting is set to "tyP1").

CW CONVENIENCE FEATURES

CONTEST MEMORY KEYS (USING THE OPTIONAL FH-2 REMOTE CONTROL KEYPAD)

TEXT Memory

The five channels of CW message memory (up to 50 characters each) may also be programmed using a text-entry technique. This technique is somewhat slower than when you send the message directly from your keyer paddle, but accuracy of character spacing is ensured.

Example 1: CQ CQ CQ DE W6DXC K (20 characters)

The sequential Contest Number (“Count up”) feature is another powerful feature of the CW Memory Keyer.

Example 2: 599 10 200 # K (15 characters)

TEXT MEMORY STORAGE

1. Press the **[MENU]** button to enter the Menu mode.
2. Rotate the **[SELECT]** knob to select the CW Memory Register into which you wish to store the message; we are now setting the message entry technique to (Text entry).

019 KEY CW MEM1
020 KEY CW MEM2
021 KEY CW MEM3
022 KEY CW MEM4
023 KEY CW MEM5

ADVICE:

Press the **[SELECT]** knob to toggle the Menu item display between “Menu Item Number & Group Name” and “Menu Function”.

3. Rotate the **[CLAR/VFO-B]** knob to set the selected CW Memory Register to “tyP1”. If you want to use text message entry on all memories, set all five Menu items (#019 ~ 023) to “tyP1”.
4. Press and hold in the **[MENU]** button for one second to save the new settings and exit.

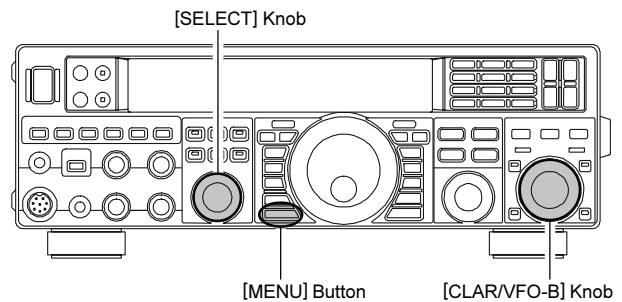

CW CONVENIENCE FEATURES

CONTEST MEMORY KEYER (USING THE OPTIONAL FH-2 REMOTE CONTROL KEYPAD)

TEXT MESSAGE PROGRAMMING

1. Press the [CW] button to set the operating mode to CW.
2. Be sure that Break-in is "Off" by pressing the [BK-IN] button, if necessary.
3. Press the FH-2 [MEM] key. A blinking "REC" icon will appear in the display.

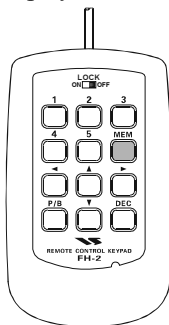

4. Press an FH-2 [1] ~ [5] key to select the desired CW Memory Register into which you wish to program the text, the blinking "REC" icon will be disappeared.

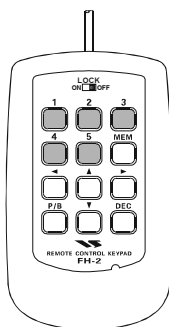

5. Use the FH-2's [◀] and [▶] keys to set the cursor position and use the FH-2's [▲] and [▼] keys to choose the letter/number to be programmed in each slot of the memory. In the case of the second example above, the "#" character designates the slot where the Contest Number will appear.

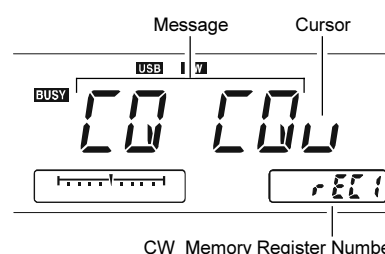
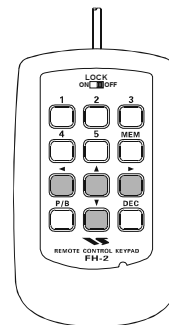

ADVICE:

You may also use the Main Tuning Dial knob and the [CLAR/VFO-B] knobs to program the message characters.

6. When the message is complete, add the "}" character at the end to signify the termination of the message.
7. Press and hold in the FH-2's [MEM] key for one second to exit, once all characters (including "}") have been programmed.

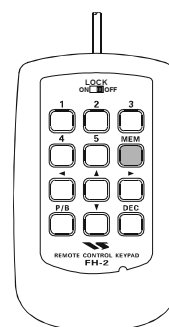

Deleting Previously-stored Characters

Use the FH-2's [◀] and [▶] keys or Main Tuning Dial knob to select the last correct letter in the message. Now use the FH-2's [▲] and [▼] keys or rotate the [CLAR/VFO-B] knob to select the "}" character; everything after the "}" character will be deleted.

CW CONVENIENCE FEATURES

CONTEST MEMORY KEYS (USING THE OPTIONAL FH-2 REMOTE CONTROL KEYPAD)

CHECKING THE CW MEMORY CONTENTS

1. Be sure that Break-in is still turned “Off” by the [BK-IN] key.
2. Press the [MONI] button to enable the CW monitor. The “MONI” icon will appear in the display.
3. Press an FH-2 [1] ~ [5] key, whichever one you just recorded in. You will hear the results in the sidetone, but no RF energy will be transmitted.

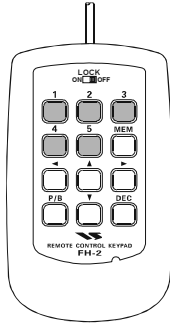

NOTE:

You may adjust the monitor level using the [MONI] knob.

ON-THE-AIR CW MESSAGE PLAYBACK

1. Press the [BK-IN] button to enable transmission. Either Full- or Semi-break-in will be engaged, depending on the setting of Menu item “043 A1A BK-IN”.
2. Press an FH-2 [1] ~ [5] key, depending on which CW Memory Register message you wish to transmit. The programmed message will be transmitted on the air.

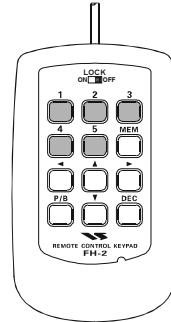

NOTE:

If you subsequently decide to use the “Message Memory” technique for memory storage, please note that the contents of a message stored using text input will not be transferred over when you set entry to “Message Memory technique” on a particular memory register (the Menu Mode Setting is set to “tyP2”).

Decrementing the Contest Number

Use this process if the current contest number gets slightly ahead of the actual number you want to send (in case of a duplicate QSO, for example).

Press the FH-2 [DEC] key momentarily. The current Contest Number will be reduced by one. Press the FH-2's [DEC] key as many times as necessary to reach the desired number. If you go too far, use the “Contest Number Programming” technique described previously.

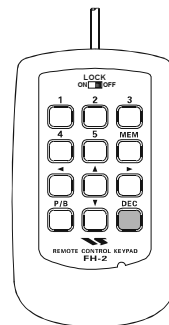

BASIC OPERATION

1. Press the **[AM/FM]** button several times, until the “**FM**” icon will appear in the display, to select the FM operating mode.
2. Rotate the Main Tuning Dial knob to select the desired operating frequency. Pressing the microphone’s **[UP]** or **[DWN]** button will cause frequency change in 5 kHz steps.
3. Press the microphone’s **PTT** switch (or press the front panel **[MOX]** button) to transmit. Speak into the microphone in a normal voice level. Release the **PTT** or **[MOX]** switch to return to receive.
4. Adjustment of the microphone gain may be accomplished in two ways. At the factory, a default level has been programmed that should be satisfactory for most situations. However, using Menu item “056 F3E FM MIC”, you may set a different fixed value, or choose the “ur” option, which then lets you use the front panel **[MIC GAIN]** knob to set the microphone gain in the FM mode.

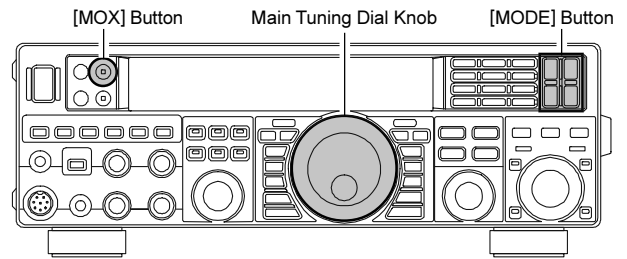

ADVICE:

- You may change the tuning step of the Main Tuning Dial knob via the Menu item “089 TUN FM DIAL”.
- You may change the tuning step of the microphone’s **[UP]/[DWN]** button via the Menu item “088 TUN FM STEP”.
- The Transmit Monitor is another helpful way to verify proper adjustment of the FM MIC Gain. By pressing the **[MONI]** button, then adjusting the **[MONI]** knob for a comfortable listening level while you are transmitting, you will be able to hear the difference in deviation as you make adjustments.
- FM is only used in the 28 MHz and 50 MHz Amateur bands covered by the **FT-950**. Please do not use FM on any other bands.

FM MODE OPERATION

REPEATER OPERATION

The **FT-950** may be utilized on 29 MHz and 50 MHz repeaters.

1. Rotate the Main Tuning Dial knob to the output frequency (downlink) from the repeater.
2. If CTCSS Tone operation is desired/needed, press and hold in the **[AM/FM]** button for one second to engage the CTCSS mode.
3. Rotate the Main Tuning Dial knob to select the desired CTCSS mode. If you just need to send the uplink encoding tone, select "TN." For encode/decode operation, choose "TS" instead. The available choices are "OFF" → "TN (Tone Encoder)" → "TS (Tone Squelch)" → "OFF".
4. Rotate the **[CLAR/VFO-B]** knob to select the desired CTCSS Tone to be used. A total of 50 standard CTCSS tones are provided (see the CTCSS Tone Chart).
5. Press the **[AM/FM]** Mode button to select the desired repeater shift direction. The selections are: "S" → "+" → "-" → "S" where "S" represents "Simplex" operation (not used on a repeater).
6. Press and hold in the **[AM/FM]** button for one second to exit from the repeater setup mode.
7. Close the microphone's **PTT** switch (or press the **[MOX]** button) to begin transmission. You will observe that the frequency has shifted to correspond to the programming you set up in the previous steps, and a "T" notation will appear on the "10 Hz" frequency digit while transmitting. Speak into the microphone in a normal voice level. Release the **PTT** switch or **[MOX]** button to return to the receive mode.

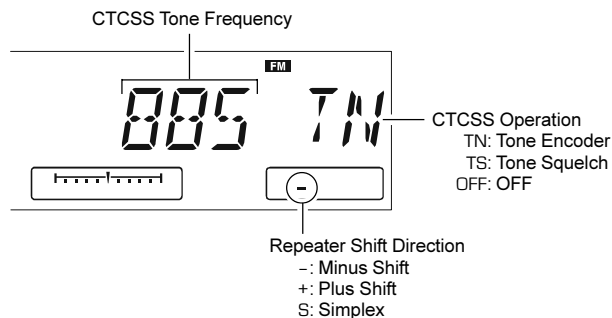
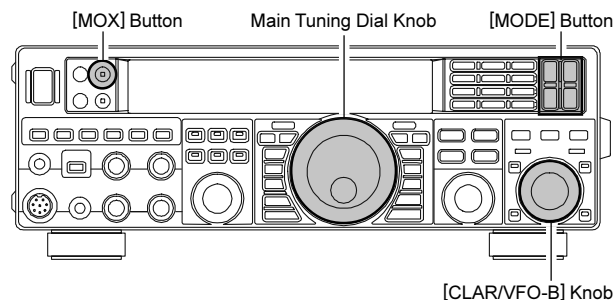

| CTCSS TONE FREQUENCY (Hz) | | | | | | | |
|---------------------------|-------|-------|-------|-------|-------|-------|-------|
| 67.0 | 69.3 | 71.9 | 74.4 | 77.0 | 79.7 | 82.5 | 85.4 |
| 88.5 | 91.5 | 94.8 | 97.4 | 100.0 | 103.5 | 107.2 | 110.9 |
| 114.8 | 118.8 | 123.0 | 127.3 | 131.8 | 136.5 | 141.3 | 146.2 |
| 151.4 | 156.7 | 159.8 | 162.2 | 165.5 | 167.9 | 171.3 | 173.8 |
| 177.3 | 179.9 | 183.5 | 186.2 | 189.9 | 192.8 | 196.6 | 199.5 |
| 203.5 | 206.5 | 210.7 | 218.1 | 225.7 | 229.1 | 233.6 | 241.8 |
| 250.3 | 251.4 | - | - | - | - | - | - |

ADVICE:

- ❑ The Repeater operation will be memorized independently on each VFO stack of the VFO-A and VFO-B.
- ❑ The conventional repeater shift used on 29 MHz is 100 kHz, while on the 50 MHz band the shift may vary between 500 kHz and 1.7 MHz (or more). To program the proper repeater shift, use Menu items "057 F3E 28 RPT" (28 MHz) and "058 F3E 50 RPT" (50 MHz), as appropriate.

TONE SQUELCH OPERATION

You may also use “Tone Squelch” whereby your receiver will be kept silent until an incoming signal modulated with a matching CTCSS tone is received. Your receiver’s squelch will then open in response to the reception of the required tone.

1. Rotate the Main tuning Dial to the output frequency (downlink) from the repeater.
2. Press and hold in the **[AM/FM]** button for one second to engage the CTCSS mode.
3. Rotate the Main Tuning Dial to choose “TS” from the available choices of
“OFF” → “TN (Tone Encoder)”
→ “TS (Tone Squelch)” → “OFF”
4. Rotate the **[CLAR/VFO-B]** knob to select the desired CTCSS Tone to be used. Fifty standard CTCSS tones are provided (see the CTCSS Tone Chart).
5. Press and hold in the **[AM/FM]** button for one second. A “D” notation on the “10 Hz” frequency digit in the display will indicate that the Tone Decoder is engaged. A “T” notation on the “10 Hz” frequency digit while transmitting will indicate that the Tone Squelch is engaged.

ADVICE:

The Tone Squelch operation will be memorized independently on each VFO stack of the VFO-A and VFO-B.

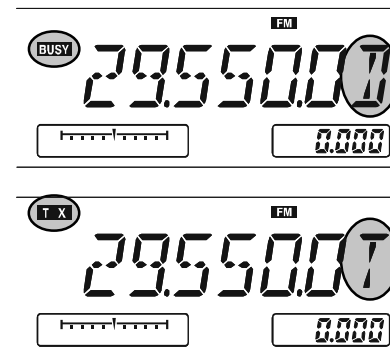
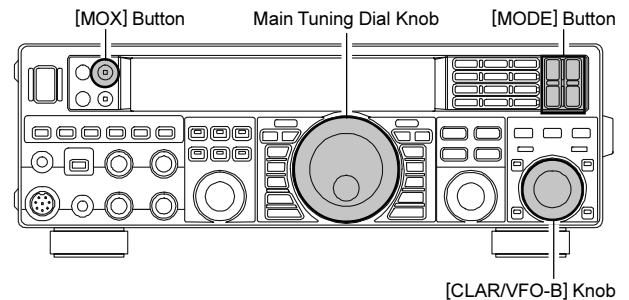

MEMORY OPERATION

CONVENIENT MEMORY FUNCTIONS

The **FT-950** contains ninety-nine regular memories, labeled “01” through “99”, nine special programmed limit memory pairs, labeled “P1L/P1U” through “P9L/P9U”, and five QMB (Quick Memory Bank) memories, labeled “C-1” through “C-5”. Each stores various settings, in addition to the VFO-A frequency and mode (See below). By default, the 99 regular memories are contained in one group; however, they can be arranged in up to six separate groups, if desired.

QUICK POINT:

The **FT-950**'s memory channels store the following data (not just the operating frequency):

- VFO-A Frequency
- VFO-A Mode
- Clarifier status and its Offset Frequency
- ANT status
- IPO status
- Roofing filter status and its Bandwidth
- Attenuator status
- Noise Blanker status
- IF SHIFT and WIDTH status
- CONTOUR status and its Peak Frequency
- DSP Noise Reduction (DNR) status and its Reduction algorithm selection.
- DSP Notch filter (NOTCH) status
- NAR bandwidth status
- DSP Auto Notch filter (DNF) status
- Repeater Shift Direction and CTCSS Tone Frequency

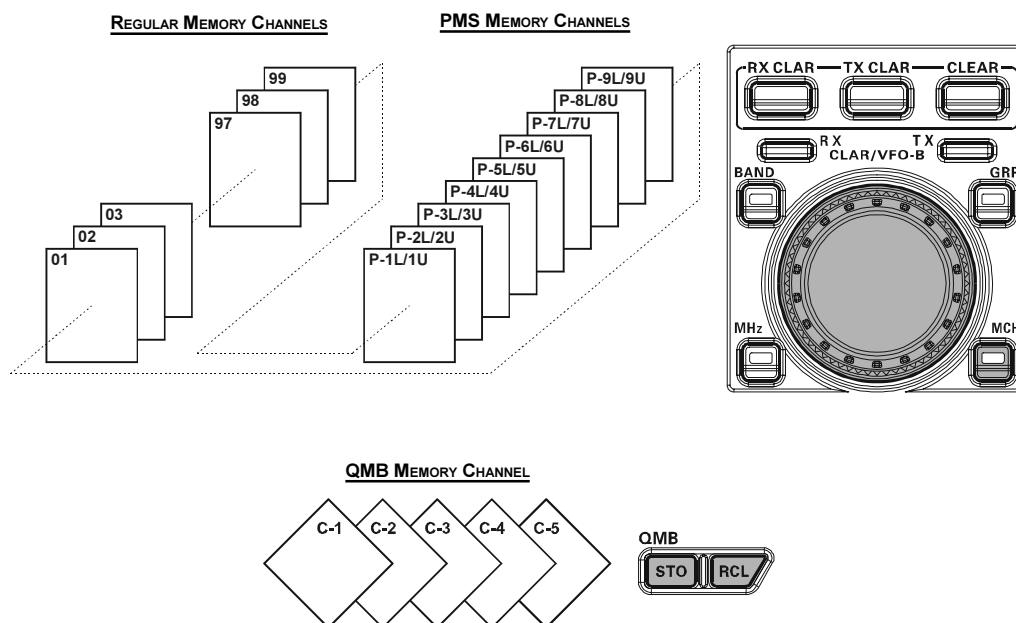

QMB (QUICK MEMORY BANK)

The Quick Memory Bank consists of five memories (labeled “C-1” through “C-5.”) independent from the regular and PMS memories. These can quickly store operating parameters for later recall.

QMB Channel Storage

1. Tune to the desired frequency on the VFO-A.
2. Press the blue **[QMB(STO)]** button. The “beep” will confirm that the VFO-A contents have been written to the currently available QMB memory.

If you repeatedly press the **[QMB(STO)]** button, the QMB memories will be written in the following order:

C-2 → C-3 → C-4 → C-5 → C-1.

Once all five QMB memories have data on them, previous data (starting with channel C-1) will be over-written on a first-in, first-out basis.

QMB Channel Recall

1. Press the **[QMB(RCL)]** button. The current QMB channel’s data will be shown on the frequency display field and the QMB memory channel number will be shown in the Multi-Display Window.
2. Repeatedly pressing the **[QMB(RCL)]** button will toggle you through the QMB channels:
C-2 → C-3 → C-4 → C-5 → C-1.
3. Press the **[V/M]** button to return to the VFO or Memory mode.

ADVICE:

Rotating the Main Tuning Dial knob, or changing the operating mode, will place the transceiver in the “Memory Tune” mode, which is a temporary “pseudo-VFO” method of tuning off of a stored memory channel. If you do not over-write the contents of the current memory channel, the original contents will not be disturbed by the initiation of Memory Tune operation.

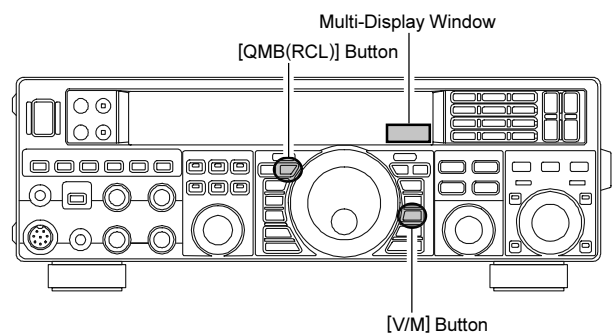
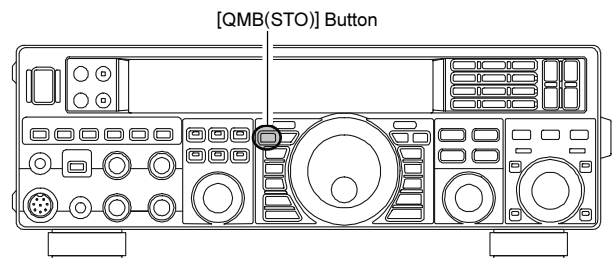

MEMORY OPERATION

STANDARD MEMORY OPERATION

The Standard Memory of the **FT-950** allows storage and recall of up to 99 memories, each storing frequency, mode, and a wide variety of status information detailed previously. Memories may be grouped into as many as six Memory Groups, and additionally you get nine pairs of band-limit (PMS) memories along with five QMB (Quick Memory Bank) memories.

Memory Storage

1. Set the VFO-A up with the frequency, mode, and status, the way you want to have it stored.
2. Press the **[A▶M]** button momentarily (the current channel number will start blinking in the Multi-Panel Window); the contents of the current memory channel will be shown on the frequency display field.
3. Rotate the **[CLAR/VFO-B]** knob to select the memory channel onto which you wish to store the data. If you have selected a channel on which data is already stored, that frequency will appear on the display.
4. Press and hold in the **[A▶M]** button for one second to store the frequency and other data into the selected memory channel. A double beep will confirm that you have held the **[A▶M]** button in long enough.

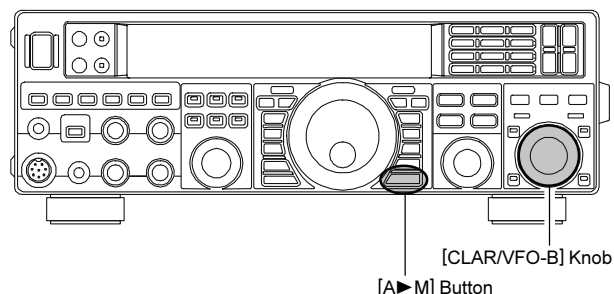

Memory Channel Recall

1. Press the **[V/M]** button, if necessary, to enter the "Memory mode". A memory channel number will appear in the Multi-Panel Window.

ADVICE:

If you cannot enter the "Memory mode", check the **[VFO-B(RX)]** Indicator/Switch. If it is illuminated green, press the **[VFO-A(RX)]** Indicator/Switch to make the **[VFO-B(RX)]** Indicator/Switch go out, then press the **[V/M]** button again.

2. Press the **[MCH]** button. The orange LED inside the button will light up, indicating that you are ready to recall a memory channel.
3. After pressing the **[MCH]** button, you may rotate the **[CLAR/VFO-B]** knob to select the desired memory channel.

ADVICE:

To work within a particular Memory Group, press the **[GRP]** button (the imbedded LED will glow orange), then rotate the **[CLAR/VFO-B]** knob to select the desired Memory Group. Now press the **[MCH]** button (the imbedded LED will glow orange); you may now choose the memory channel within the selected Memory Group.

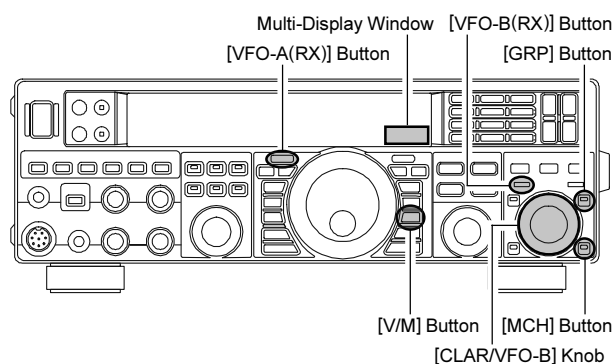

STANDARD MEMORY OPERATION

Checking a Memory Channel's Status

Before programming a channel into memory, you can check the current contents of that channel without the danger of overwriting the channel accidentally.

1. Press the [**A▶M**] button momentarily.
The data stored in the currently selected memory channel will be displayed in the frequency field. However, since you are only checking the contents of the memory channel, your radio will not have moved to the memory channel's frequency.
2. Rotate the [**CLAR/VFO-B**] knob to select a different memory channel. To exit from the Memory Check mode, press the [**A▶M**] button momentarily once more.

ADVICE:

- While the Memory Check function is engaged, the memory channel number will blink in the Multi-Display Window.
- While operating in the VFO mode, using Memory Check, you may store the current VFO frequency into the selected memory by pressing and holding in the [**A▶M**] button for one second (until the double beep). Conversely, if you wish to write the contents of the current memory into the VFO-A register, press and hold in the [**M▶A**] button for one second.

Erasing Memory Channel Data

1. Press the [**V/M**] button, if necessary, to enter the VFO mode.
2. Press the [**A▶M**] button. The data stored in the currently selected memory channel will be displayed in the frequency field.
3. Rotate the [**CLAR/VFO-B**] knob to select the memory channel that you would like to erase. The memory channel number appears in the Multi-Panel Window.
4. Press the [**LOCK**] button to erase the contents of the selected memory channel.

ADVICE:

- The **FT-950** can not erase the memory channels "01" (and "US1" through "US5": U.S. version).
- After erasure, only the memory channel number will remain; the frequency data will disappear from the display.
- If you make a mistake and wish to restore the memory's contents, just repeat steps (1) through (4) above.

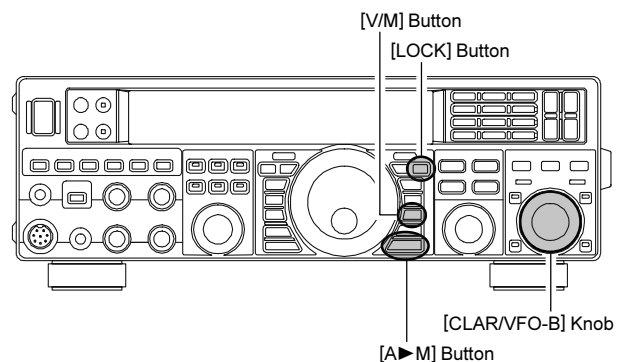
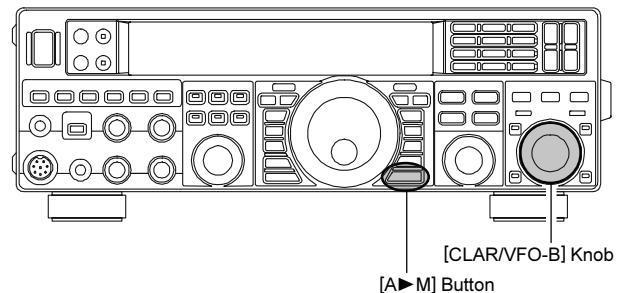

MEMORY OPERATION

STANDARD MEMORY OPERATION

Moving Memory Data to the VFO-A register

You may transfer the contents of the currently selected memory channel into the VFO-A register, if you like.

1. Press the **[V/M]** button, as necessary, to go to the “Memory” mode. The memory channel number will appear in the multi-panel window.

ADVICE:

If you can not enter the “Memory” mode, check to see if the transceiver is in VFO-B mode (the green **[VFO-B(RX)]** Indicator/Switch is illuminated). If so, press the **[VFO-A(RX)]** Indicator/Switch to return operation to VFO-A. Now, press the **[V/M]** button to enter the “Memory” mode.

2. Press the **[MCH]** button. The orange LED inside the switch will light up, indicating that you are ready to recall a memory channel.
3. Rotate the **[CLAR/VFO-B]** knob to select the memory channel the contents of which you wish to transfer to VFO-A.
4. Press and hold in the **[M▶A]** button for two seconds, until you hear the double beep. The data in the selected memory channel will now be transferred to VFO-A.

ADVICE:

This transfer of data to the VFO-A does not affect the original contents of the memory channel; this is a “copy” function that leaves the memory contents unchanged.

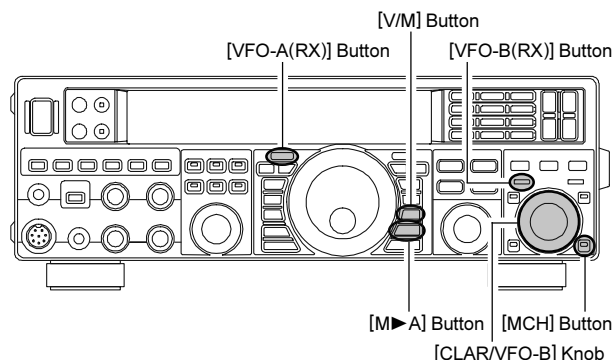

Memory Tune Operation

You may freely tune off from any memory channel in a “Memory Tune” mode, this is similar to VFO operation. So long as you do not over-write the contents of the current memory, Memory Tune operation will not alter the contents of the memory channel.

1. Press the **[V/M]** button to recall any memory channel.

ADVICE:

If you can not enter the “Memory” mode, check to see if the transceiver is in VFO-B mode (the green **[VFO-B(RX)]** Indicator/Switch is illuminated). If so, press the **[VFO-A(RX)]** Indicator/Switch to return operation to VFO-A. Now, press the **[V/M]** button to enter the “Memory” mode.

2. Rotate the Main Tuning Dial knob; you will now observe that the memory channel’s frequency is changing.

ADVICE:

- The “**MT**” icon will replace the “**MR**” icon in the multi-panel window, indicating you are in the “Memory Tune” mode.
- During Memory Tune operation, you may change operating modes, and engage the offset Clarifier, if desired.

3. Press the **[V/M]** button momentarily to return to the originally memorized frequency of the current memory channel. One more press of the **[V/M]** button will return you to VFO operation.

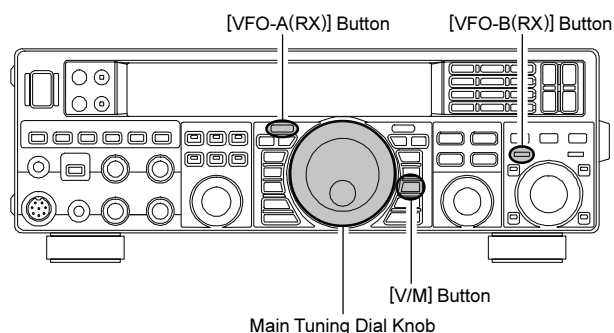

NOTE:

Computer software programs utilizing the CAT system interface port may presume that the transceiver is operating in the VFO mode, for certain features like “band mapping” and/or frequency logging, because the “Memory Tune” mode so closely resembles the VFO mode. Be sure that you have the **FT-950** operating in a control mode compatible with your software’s requirements. Use the VFO mode if you’re not sure.

MEMORY GROUPS

Memory channels may be grouped into as many as six convenient batches, for easy identification and selection. For example, you might want to designate memory groups for AM BC stations, shortwave broadcast stations, contest frequencies, repeater frequencies and PMS limits, or any other groupings you like.

Each memory group is capable of holding up to 20 memory channels (except Memory Group 01: it is 19 memory channels, and the Group size is fixed). When a memory channel is grouped, the channel numbers change to correspond to the chart

below:

Memory Group Assignment

1. Press the **[MENU]** button to enter the Menu mode.
2. Rotate the **[SELECT]** knob to select Menu item "029 GENE MEM GRP".

ADVICE:

Press the **[SELECT]** knob momentarily to toggle the Menu item display between "029 GENE" and "MEM GRP".

3. Rotate the **[CLAR/VFO-B]** knob to set this Menu item to "On" (the default setting is "OFF").
4. Press and hold in the **[MENU]** button for one second to save the new setting and exit. Operation will now be restricted to the six Memory Groups.

To cancel Memory Group operation, repeat steps (1) through (4) above, choosing "OFF" in step (3).

ADVICE:

To avoid confusion, note that the PMS memory group and the PMS memories "P1L" through "P9U" will be so designated.

Choosing the Desired Memory Group

You may recall memories just within a particular Memory Group, if desired.

1. Press the **[V/M]** button, if necessary, to enter the "Memory" mode.

ADVICE:

If you can not enter the "Memory" mode, check to see if the transceiver is in VFO-B mode (the green **[VFO-B(RX)]** Indicator/Switch is illuminated). If so, press the **[VFO-A(RX)]** Indicator/Switch to return operation to VFO-A. Now, press the **[V/M]** button to enter the "Memory" mode.

2. Press the **[GRP]** button (located to the upper right of the **[CLAR/VFO-B]** knob). The imbedded LED inside the switch will glow orange.
3. Rotate the **[CLAR/VFO-B]** knob to select the desired Memory Group.
4. Press the **[MCH]** button (just below the **[GRP]** button). The imbedded LED inside the switch will glow orange.
5. Rotate the **[CLAR/VFO-B]** knob to select the desired Memory Channel within the Selected Memory Group.

ADVICE:

If no channels have been assigned to a particular Memory Group, you will not have access to that Group.

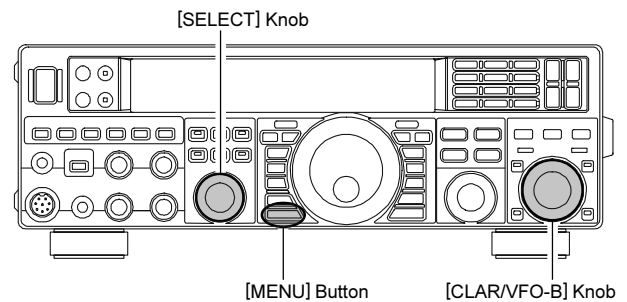

| MEMORY CHANNEL NUMBER | |
|-----------------------|-------------------|
| GROUP MEMORY "OFF" | GROUP MEMORY "ON" |
| 01 ~ 19 | 1-01 ~ 1-19 |
| 20 ~ 39 | 2-01 ~ 2-20 |
| 40 ~ 59 | 3-01 ~ 3-20 |
| 60 ~ 79 | 4-01 ~ 4-20 |
| 80 ~ 99 | 5-01 ~ 5-20 |
| P-1L/1U ~ P-9L/9U | P-1L/1U ~ P-9L/9U |
| US1 ~ US5 | US-1 ~ US-5 |

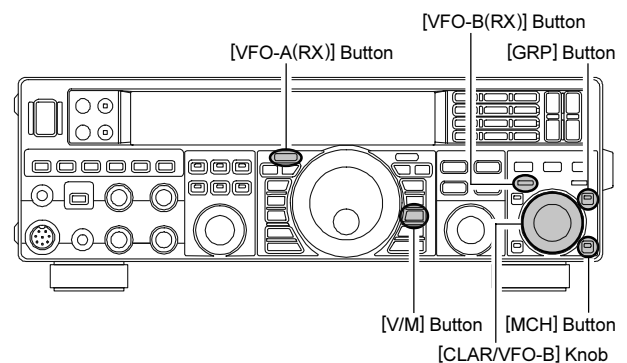

OPERATION ON ALASKA EMERGENCY FREQUENCY: 5167.5 kHz (U.S. VERSION ONLY)

Section 97.401(d) of the regulations governing amateur radio in the United States permit emergency amateur communications on the spot frequency of 5167.5 kHz by stations in (or within 92.6 km of) the state of Alaska. This frequency is only to be used when the immediate safety of human life and/or property are threatened, and is never to be used for routine communications.

The **FT-950** includes the capability for transmission and reception on 5167.5 kHz under such emergency conditions via the Menu system. To activate this feature:

1. Press the **[MENU]** button to enter the Menu mode.
2. Rotate the **[SELECT]** knob to select Menu item “118 TGEN EMRGNCY”.

ADVICE:

Press the **[SELECT]** knob momentarily to toggle the Menu item display between “118 TGEN” and “EMRGNCY”.

3. Rotate the **[CLAR/VFO-B]** knob to select “EnA (Enable).”
4. Press and hold in the **[MENU]** button for one second to save the new setting and exit to normal operation. Emergency communication on this spot frequency is now possible.
5. Press the **[V/M]** button, as necessary, to enter the Memory mode. Press the **[MCH]** button, then rotate the **[CLAR/VFO-B]** knob to select the emergency channel (“EUS”), which is found between channels “US5” and “01”.

NOTE:

- ❑ The receive-mode CLARIFIER functions normally while using this frequency, but variation of the transmit frequency is not possible. Activation of “118 TGEN EMRGNCY” does not enable any other out of amateur band capability on the transceiver. The full specifications of the **FT-950** are not necessarily guaranteed on this frequency, but power output and receiver sensitivity should be fully satisfactory for the purpose of emergency communication.
- ❑ If you wish to disable operation capability on the Alaska Emergency Frequency, repeat the above procedures, but set “118 TGEN EMRGNCY” to “diS” in step 3.
- ❑ In an emergency, note that a half-wave dipole cut for this frequency should be approximately 45’3” on each leg (90’6” total length). Emergency operation on 5167.5 kHz is shared with the Alaska-Fixed Service. This transceiver is not authorized for operation, under the FCC’s Part 87, for aeronautical communications.

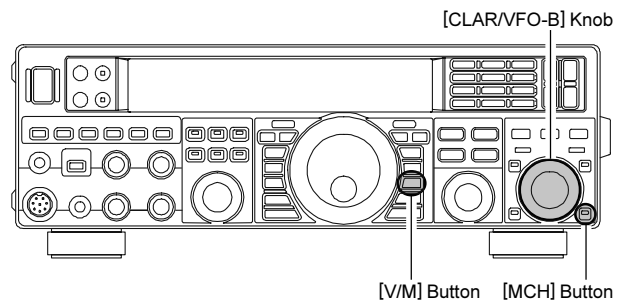
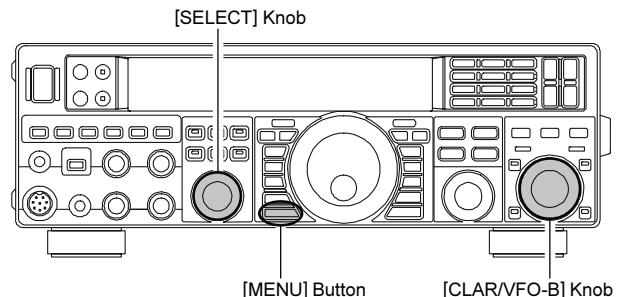

VFO AND MEMORY SCANNING

You may scan either the VFO or the memories of the **FT-950**, and the radio will halt scanning on any station with a signal strong enough to open the receiver's squelch.

VFO SCANNING

1. Set the VFO-A to the frequency on which you would like to begin scanning.
2. Rotate the **[SQL]** knob so that the background noise is just silenced.
3. Press and hold in the microphone's **[UP]** or **[DWN]** key for one second to start scanning in the specified direction on the VFO frequency.

ADVICE:

If you would like to begin scanning on the VFO-B frequency, press the **[VFO-B(RX)]** Indicator/Switch first, then press and hold in the microphone's **[UP]** or **[DWN]** key for one second.

4. If the scanner halts on an incoming signal, the decimal point between the "MHz" and "kHz" digits of the frequency display will blink.

ADVICE:

- If the incoming signal disappears, scanning will resume in about five seconds.
- On the SSB/CW and SSB-based Data modes, the scanner will pause on a received signal, then will step across the signal very slowly, giving you time to stop the scan, if you like. In these modes on the VFO, the scanner does not stop, however.

5. To cancel scanning, press the microphone's **[UP]** or **[DWN]** key momentarily.

ADVICE:

You may select the manner in which the scanner resumes while it has paused on a signal, using Menu item "034 GENE SCN RSM". The default "5SEc" setting will cause the scanner to resume scanning after five seconds; you may change it, however, to resume only after the carrier has dropped out, if you like See page 111.

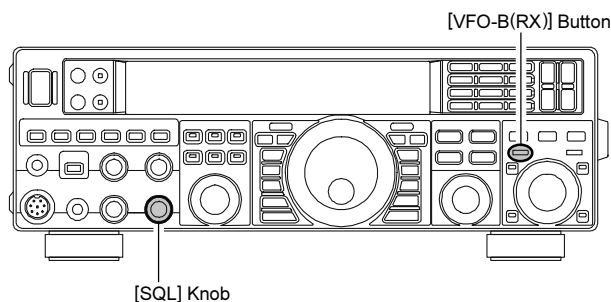

VFO AND MEMORY SCANNING

MEMORY SCAN

1. Set the transceiver up in the “Memory” mode by pressing the **[V/M]** button, if necessary.

ADVICE:

If you can not enter the “Memory” mode, check to see if the transceiver is in VFO-B mode (the green **[VFO-B(RX)]** Indicator/Switch is illuminated). If so, press the **[VFO-A(RX)]** Indicator/Switch to return operation to VFO-A. Now, press the **[V/M]** button to enter the “Memory” mode.

2. Rotate the **[SQL]** knob so that the background noise is just silenced.
3. Press and hold in the microphone’s **[UP]** or **[DWN]** key for one second to start scanning in the specified direction.

ADVICE:

- If the scanner halts on an incoming signal, the decimal point between the “MHz” and “kHz” digits of the frequency display will blink.
- If the incoming signal disappears, scanning will resume in about five seconds.

4. To cancel scanning, press the microphone’s **[UP]** or **[DWN]** key momentarily.

ADVICE:

- During Memory Group operation, only the channels within the current Memory Group will be scanned.
- If the scan has paused on a signal, pressing the microphone’s **[UP]** or **[DWN]** key will cause scanning to resume instantly.
- If you press the microphone’s **PTT** switch during scanning, the scanner will halt at once. However, pressing the **PTT** switch during scanning will not cause transmission.
- You may select the manner in which the scanner resumes while it has paused on a signal, using Menu item “034 GEN E SCN RSM”. During memory scanning, the default “5SEC” setting will cause the scanner to resume scanning after five seconds. However, you may change this setting to resume only after the carrier has dropped out, if you like. See page 111.

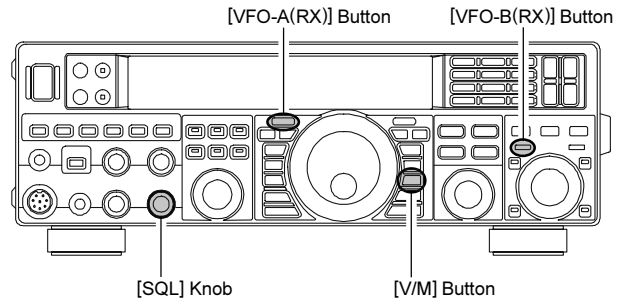

QUICK POINT:

If you have no interest in scanning, and wish to prohibit the microphone’s **[UP]**/**[DWN]** keys from initiating scanning, you may disable scanning control from the microphone using Menu item “033 GENE MIC SCN” (set it to “OFF”).

PMS (PROGRAMMABLE MEMORY SCANNING)

To limit scanning (and manual tuning) within a particular frequency range, you can use the Programmable Memory Scanning (PMS) feature, which utilizes nine special-purpose memory pairs (“P1L/P1U” through “P9L/P9U”). The PMS feature is especially useful in helping you to observe any operating sub-band limits, which apply to your Amateur license class.

1. Store the Lower and Upper tuning/scanning limit frequencies into the memory pair “P1L” and “P1U”, respectively, or any other “L/U” pair of memories in the special PMS memory area. See page 92 for details regarding memory storage.
2. Press the **[V/M]** button to enter the “Memory” mode.

ADVICE:

If you can not enter the “Memory” mode, check to see if the transceiver is in VFO-B mode (the green **[VFO-B(RX)]** Indicator/Switch is illuminated). If so, press the **[VFO-A(RX)]** Indicator/Switch to return operation to VFO-A. Now, press the **[V/M]** button to enter the “Memory” mode.

3. Press the **[MCH]** button momentarily. The imbedded LED inside the switch will glow orange.
4. Rotate the **[CLAR/VFO-B]** knob to select memory channel “P1L” or “P1U”.
5. Rotate the **[SQL]** knob so that the background noise is just silenced.
6. Turn the Main Tuning Dial knob slightly (to activate memory tuning). Tuning and scanning are now limited to the range within the P1L/P1U limits until you press the **[V/M]** button to return to memory channel or VFO operation.
7. Press and hold in the microphone’s **[UP]** or **[DWN]** key for one second to start scanning in the specified direction.

ADVICE:

- If the scanner halts on an incoming signal, the decimal point between the “MHz” and “kHz” digits of the frequency display will blink.
 - If the incoming signal disappears, scanning will resume in about five seconds.
 - On the SSB/CW and SSB-based Data modes, the scanner will pause on a received signal, then will step across the signal very slowly, giving you time to stop the scan, if you like. However, in these modes on the VFO, the scanner does not stop.
 - If the scan has paused on a signal, pressing the microphone’s **[UP]** or **[DWN]** key will cause scanning to resume instantly.
8. If you rotate the Main Tuning Dial knob in the opposite direction from the current scanning direction (in other words, you rotate the dial to the left when scanning toward a higher frequency), the direction of the scan will reverse.
 9. If you press the microphone’s **PTT** switch during scanning, the scanner will halt at once. Pressing the **PTT** switch *during scanning* will not cause transmission.

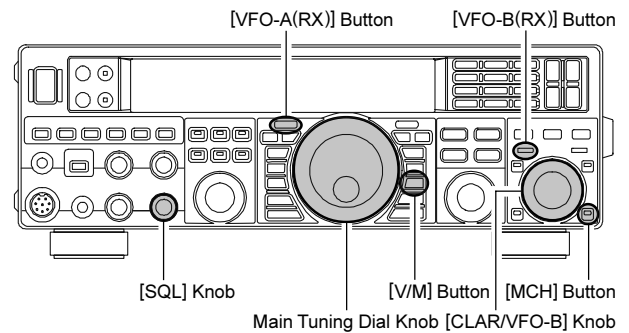

PACKET OPERATION

Packet operation is easily accomplished on the **FT-950** by connecting your TNC (Terminal Node Controller) to the transceiver, per the illustration. “Packet” operation also applies to SSB-based AFSK data modes, such as PSK31, etc.

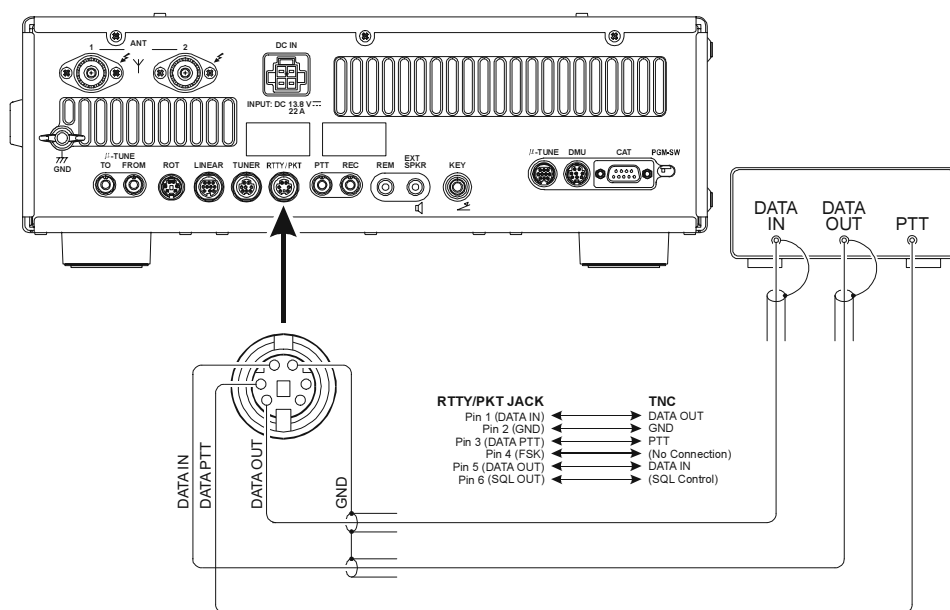

PACKET SETUP (INCLUDING SUBCARRIER FREQUENCY)

Before operation can commence, some basic setup procedures must be performed using the Menu, to configure your radio for the data mode to be used.

| MENU ITEM | AVAILABLE VALUES | MENU ITEM | AVAILABLE VALUES |
|------------------|------------------|------------------|--------------------|
| 050 DATA DT GAIN | 0 ~ 100 | 053 DATA V GAIN | 0 ~ 100 |
| 051 DATA OUT LVL | 0 ~ 100 | 054 DADA PKTDISP | -3000 ~ +3000 (Hz) |
| 052 DATA VOX DLY | 30 ~ 3000 (ms) | 055 DATA PKT SFT | -3000 ~ +3000 (Hz) |

BASIC SETUP

- Press the **[RTTY/PKT]** button, briefly, to toggle the selected Packet mode. Press the **[RTTY/PKT]** button to toggle the mode between “PKT-LSB” and “RTTY-LSB”.

ADVICE:

- When both “**PKT**” and “**LSB**” icons appear on the display, the mode is LSB SSB-based Data operation which is generally used for HF operation.
 - If you need to do FM-based 1200-baud packet on the 29/50 MHz bands, press and hold in the **[RTTY/PKT]** button repeatedly until the “**PKT**” and “**FM**” icons appear on the display, to engage the “PKT-FM” mode.
 - To operate USB SSB-based Data modes, press and hold in the **[RTTY/PKT]** button repeatedly until the “**PKT**” and “**USB**” icons are shown on the display, the **FT-950** is configured for Packet operation in the “USB” mode.
- When the “transmit” command is received from the TNC, the transmitter of the **FT-950** will automatically be engaged. Likewise, the command to return to receive will cause the radio to revert to the receive mode.

ADVICE:

- If you need to adjust the output level from the “DATA OUT” pin (pin 5) of the **RTTY/PKT** jack on the rear panel of the transceiver, please use Menu item “051 DATA OUT LVL”. For the input level from the TNC, as applied to the DATA IN pin (pin 1) of the **RTTY/PKT** jack, please use Menu item “050 DATA DT GAIN”.
- During Packet operation via the rear panel’s **RTTY/PKT** jack, the front panel **MIC** jack is cut off, so you won’t have a “live microphone” problem during data operation.

NOTE:

If you anticipate making data transmissions of longer than a few minutes, we recommend that you reduce the transmitter power to 1/3 ~ 1/2 of its normal maximum via the Menu item “111 TGEN TX PWR”.

QUICK POINT:

RTTY/PKT Jack Specifications

DATA IN (Pin 1)

Nominal Input Level: 50 mVp-p

Impedance: 10 k-Ohms

DATA OUT (Pin 5)

Maximum Output Level: 100 mVp-p

Impedance: 10 k-Ohms

RTTY (RADIO TELETYPE) OPERATION

Most RTTY operation today is accomplished using a TNC or other computer-based system that utilizes AFSK tones. As such, the previous discussion on LSB-mode “Packet” operation will apply for Baudot operation, as well. For RTTY operation using a Terminal Unit (TU) or the “FSK” output from a TNC, please see the discussion below. See also the illustration for details regarding connection to your TU.

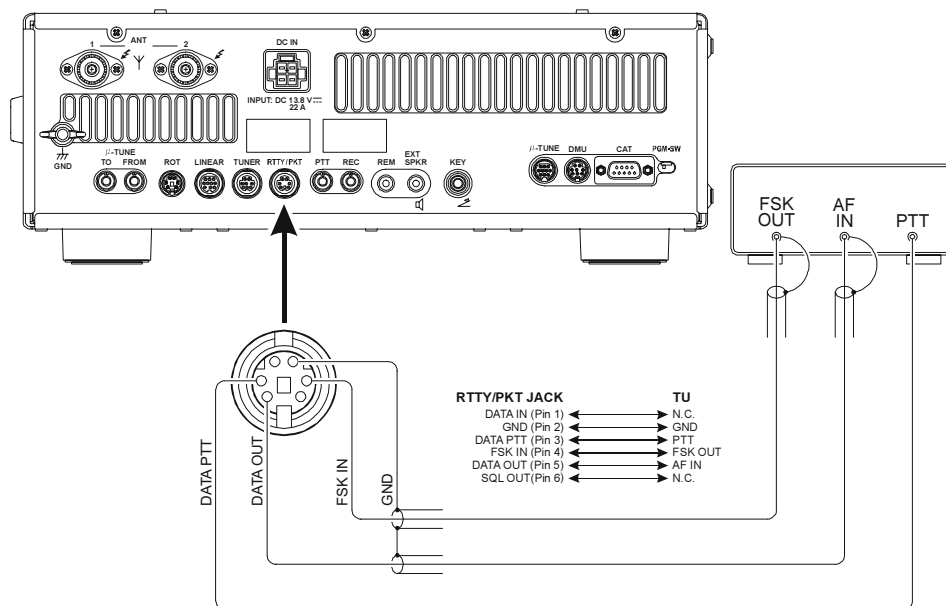

SETTING UP FOR RTTY OPERATION

Before commencing RTTY operation, please direct your attention to the setup steps shown in the chart to the right.

| MENU ITEM | AVAILABLE VALUES |
|------------------|------------------------------|
| 059 RTTY R PLRTY | nor (normal) / rEU (reverse) |
| 060 RTTY T PLRTY | nor (normal) / rEU (reverse) |
| 061 RTTY OUT LEL | 0 ~ 100 |
| 062 RTTY SHIFT | 170/200/425/850 (Hz) |
| 063 RTTY TONE | 1275/2125 (Hz) |

BASIC SETUP

- To engage RTTY operation using “LSB” injection, which is generally used in the Amateur service. Press the [RTTY/PKT] button repeatedly until both the “RTTY” and “LSB” icons appear on the display.
- To switch to USB-side injection in RTTY, press and hold in the [RTTY/PKT] button. Both the “RTTY” and “USB” icons will appear on the display.
- When you begin typing on your TU or computer keyboard, the command to transmit should automatically be sent to the transceiver, causing it to enter the transmit mode.

NOTE:

If you anticipate making data transmissions of longer than a few minutes, we recommend that you reduce the transmitter power to 1/3 ~ 1/2 of its normal maximum via the Menu item “111 TGEN TX PWR”.

ADVICE:

- If you need to adjust the output level from the “DATA OUT” pin (pin 5) of the RTTY/PKT jack on the rear panel of the transceiver, please use Menu item “061 RTTY OUT LVL”. For the input level from the TU, there is no adjustment of the FSK input level (Pin 4) of the RTTY/PKT jack. Please make any needed level adjustments at the TU side.

- The Mark/Space Shift utilized in most Amateur RTTY operation is 170 Hz. Other shifts may be configured, however, using Menu item “062 RTTY SHIFT”. The FT-950 is set up for “high tone” operation (centered on 2125 Hz) by default, but you may configure it for low tone (1275 Hz) operation using Menu item “063 RTTY TONE”.
- You may find that you are unable to decode some RTTY stations, even if they are of sufficient signal strength. If this is observed, there may be a Mark/Space polarity problem between your station and the other station. If so, try setting Menu item “059 RTTY R PLRTY” to “rEU” (“Reverse”) to see if that permits copy. A separate Menu Item permits reversal of your transmitter’s Mark/Space polarity: “060 RTTY T PLRTY”.

QUICK POINT:

In the FT-950, “RTTY” is a mode defined as being an “FSK” mode, whereby the closing and opening of a keying line (to ground) causes the Mark/Space tones to alternate. The RTTY mode is not an AFSK based mode in this transceiver, and the AFSK output tones from a TNC will not cause Mark/Space shifting to occur. Use the “Packet” mode for AFSK-based Baudot and other data modes.

MISCELLANEOUS AFSK-BASED DATA MODES

The **FT-950** may also be used for a host of other SSB-based Data modes. Please set up your system using the illustration as a guideline.

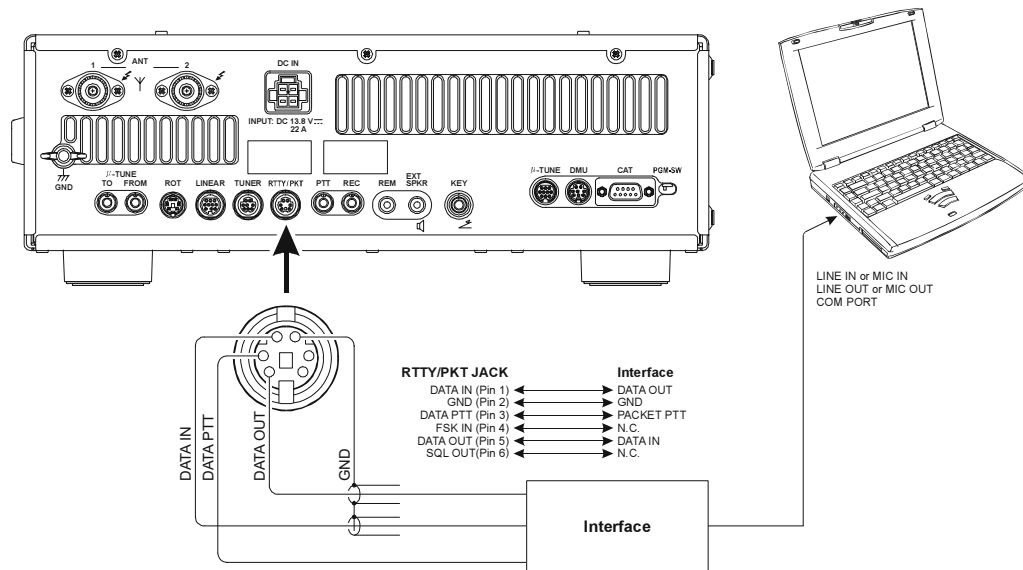

QUICK POINT:

When you have configured Menu item “114 TGEN VOX SEL” to “dAtA,” the transceiver will operate in a “VOX” mode, and it is not necessary to connect a PTT line. This makes for very convenient interfacing to computer Sound Cards, etc.

MENU MODE

The Menu system of the **FT-950** provides extensive customization capability, so you can set up your transceiver just the way you want to operate it. The Menu items are grouped by general utilization category, and are numbered from “001 AGC FST DLY” to “118 TGEN EMRGNCY”.

USING THE MENU

1. Press the **[MENU]** button momentarily, to engage the Menu mode.

The display will show the Menu Number, Menu Group Name, and Menu Item. Press the **[SELECT]** knob momentarily to toggle the display between “Menu Number & Menu Group Name” and “Menu Item”. The Multi-Display Window shows the current setting of the currently selected Menu item.

2. Rotate the **[SELECT]** knob to select the Menu item you wish to modify.
3. Rotate the **[CLAR/VFO-B]** knob to change the current setting of the selected Menu item.

ADVICE:

Press the **[CLEAR]** button (located the upper right of the **[SELECT]** knob) momentarily to reset the selected Menu item to the factory default value.

4. When you have finished making your adjustments, press and hold in the **[MENU]** button for one second to save the new setting and exit to normal operation. If you only *momentarily* press the **[MENU]** button, the new settings will *not* be retained.

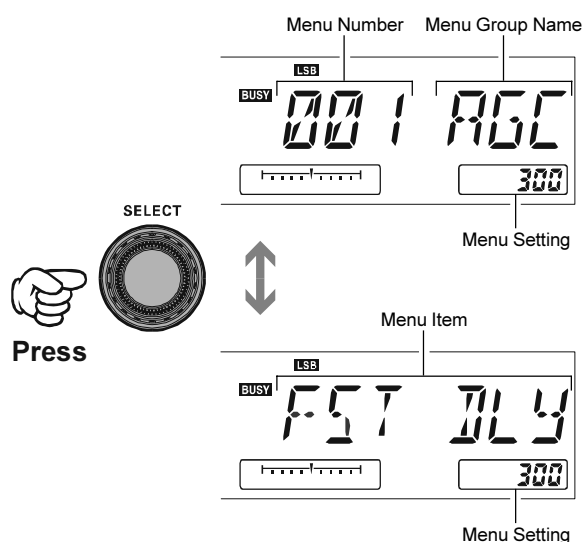
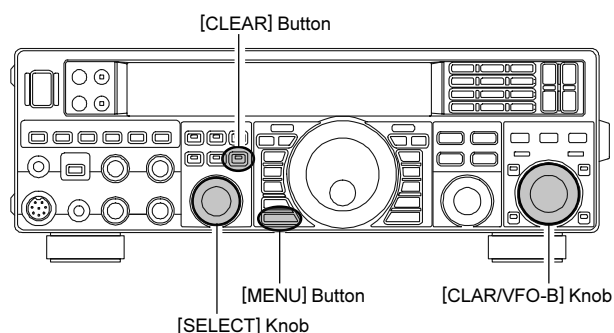

MENU MODE RESET

You may reset all the Menu settings to their original factory defaults, if desired.

1. Turn the front panel **[POWER]** switch off.
2. Press and hold in the **[MENU]** button, and while holding it in, press the **[POWER]** switch to turn the transceiver back on. Now release the **[MENU]** button.

MENU MODE

| GROUP | No. MENU FUNCTION | AVAILABLE VALUES | DEFAULT SETTING |
|---------|-------------------|--|-----------------|
| AGC | 001 AGC FST DLY | 20 ~ 4000 msec (20 msec/step) | 300 msec |
| AGC | 002 AGC MID DLY | 20 ~ 4000 msec (20 msec/step) | 700 msec |
| AGC | 003 AGC SLW DLY | 20 ~ 4000 msec (20 msec/step) | 3000 msec |
| DISPLAY | 004 DISP COLOR | bL1/bL2/bL3/ub1/ub2 | bL1*1 |
| DISPLAY | 005 DISP DIM VFD | 0 ~ 15 | 8 |
| DISPLAY | 006 DISP BAR SEL | CLAr/C-tn/u-tn | C-tn |
| DISPLAY | 007 DISP PKH S | OFF/0.5/1.0/2.0 sec | OFF |
| DISPLAY | 008 DISP PKH PO | OFF/0.5/1.0/2.0 sec | OFF |
| DISPLAY | 009 DISP PKH ALC | OFF/0.5/1.0/2.0 sec | OFF |
| DISPLAY | 010 DISP PKH ID | OFF/0.5/1.0/2.0 sec | OFF |
| DISPLAY | 011 DISP RTR STU | 0/90/180/270° | 0°*2 |
| DISPLAY | 012 DISP RTR ADJ | -30 ~ 0° (2°/step) | 0°*2 |
| DISPLAY | 013 DISP QMB MKR | On/OFF | On |
| DVS | 014 DVS RX LVL | 0 ~ 100 | 50*3 |
| DVS | 015 DVS TX LVL | 0 ~ 100 | 50*3 |
| KEYER | 016 KEY BEACON | OFF/1 ~ 240 sec (1 sec/step)/ 270 ~ 690 sec (30 sec/step) | OFF |
| KEYER | 017 KEY NUM STL | 1290/AunO/Aunt/A2nO/A2nt/12nO/12nt | 1290 |
| KEYER | 018 KEY CONTEST | 0 ~ 9999 | 1 |
| KEYER | 019 KEY CW MEM1 | tyP1/tyP2 | tyP2 |
| KEYER | 020 KEY CW MEM2 | tyP1/tyP2 | tyP2 |
| KEYER | 021 KEY CW MEM3 | tyP1/tyP2 | tyP2 |
| KEYER | 022 KEY CW MEM4 | tyP1/tyP2 | tyP2 |
| KEYER | 023 KEY CW MEM5 | tyP1/tyP2 | tyP2 |
| GENERAL | 024 GENE ANT SEL | bAnd/rEG | bAnd |
| GENERAL | 025 GENE BEP LVL | 0 ~ 100 | 50 |
| GENERAL | 026 GENE CAT BPS | 4800/9600/192H (19200)/384H (38400) bps | 4800 bps |
| GENERAL | 027 GENE CAT TOT | 10/100/1000/3000 msec | 10 msec |
| GENERAL | 028 GENE CAT RTS | On/OFF | On |
| GENERAL | 029 GENE MEM GRP | On/OFF | OFF |
| GENERAL | 030 GENE Q SPLIT | -20 ~ 0 ~ +20 kHz (1 kHz/step) | +5 kHz |
| GENERAL | 031 GENE TX TOT | OFF/1 ~ 30 min | OFF |
| GENERAL | 032 GENE uT DIAL | StP1/ StP2 | StP1*4 |
| GENERAL | 033 GENE MIC SCN | On/OFF | On |
| GENERAL | 034 GENE SCN RSM | CAr/5SEc | 5SEc |
| GENERAL | 035 GENE FRQ ADJ | -25 ~ 0 ~ +25 | 0 |
| MODE-AM | 036 A3E MICGAIN | Ur/0 ~ 100 | Ur |
| MODE-CW | 037 A1A F-TYPE | OFF/buG/ELE/ACS | ELE |
| MODE-CW | 038 A1A F-REV | nor/rEV (NORNAL/REVERSE) | nor (NORNAL) |
| MODE-CW | 039 A1A R-TYPE | OFF/buG/ELE/ACS | ELE |
| MODE-CW | 040 A1A R-REV | nor/rEV (NORNAL/REVERSE) | nor (NORNAL) |
| MODE-CW | 041 A1A CW AUTO | OFF/50/On | OFF |
| MODE-CW | 042 A1A BFO | USb/LSb/Auto | USb |
| MODE-CW | 043 A1A BK-IN | SEni/FuLL | SEni |
| MODE-CW | 044 A1A DELAY | 30 ~ 3000 msec (10 msec/step) | 200 msec |
| MODE-CW | 045 A1A PITCH | 300 ~ 1050 Hz (50 Hz/step) | 700 Hz |
| MODE-CW | 046 A1A WEIGHT | (1:) 2.5 ~ 4.5 | 3.0 |
| MODE-CW | 047 A1A FRQDISP | dir/OFSt | OFSt |
| MODE-CW | 048 A1A PC KYNG | EnA/diS (ENABLE/DISABLE) | diS (Disable) |
| MODE-CW | 049 A1A QSKTIME | 15/20/25/30 msec | 15 msec |

*1: Requires optional **DMU-2000** Data Management Unit.

*2: Requires optional Antenna Rotator.

*3: Requires optional **DVS-6** Voice Memory Unit.

*4: Requires optional RF μ Tuning Kit.

MENU MODE

| GROUP | No. MENU FUNCTION | AVAILABLE VALUES | DEFAULT SETTING |
|------------|-------------------|---------------------------------------|----------------------------|
| MODE-DATA | 050 DATA DT GAIN | 0 ~ 100 | 50 |
| MODE-DATA | 051 DATA OUT LVL | 0 ~ 100 | 50 |
| MODE-DATA | 052 DATA VOX DLY | 30 ~ 3000 msec (10 msec/step) | 300 msec |
| MODE-DATA | 053 DATA V GAIN | 0 ~ 100 | 50 |
| MODE-DATA | 054 DATA PKTDISP | -3000 ~ +3000 Hz (10 Hz/step) | 0 Hz |
| MODE-DATA | 055 DATA PKT SFT | -3000 ~ +3000 Hz (10 Hz/step) | 1000 Hz |
| MODE-FM | 056 F3E MIC | Ur/0 ~ 100 | 50 |
| MODE-FM | 057 F3E 28 RPT | 0 ~ 1000 kHz (10 kHz/step) | 100 kHz |
| MODE-FM | 058 F3E 50 RPT | 0 ~ 4000 kHz (10 kHz/step) | 1000 kHz |
| MODE-RTTY | 059 RTTY R PLRTY | nor/rEV (NORMAL/REVERSE) | nor (NORMAL) |
| MODE-RTTY | 060 RTTY T PLRTY | nor/rEV (NORMAL/REVERSE) | nor (NORMAL) |
| MODE-RTTY | 061 RTTY OUT LVL | 0 ~ 100 | 50 |
| MODE-RTTY | 062 RTTY SHIFT | 170/200/425/850 Hz | 170 Hz |
| MODE-RTTY | 063 RTTY TONE | 1275/2125 Hz | 2125 Hz |
| MODE-SSB | 064 J3E TX BPF | 1-30/1-29/2-28/3-27/4-26 | 3-27 (300 ~ 2700 Hz) |
| MODE-SSB | 065 J3E LSB CAR | -200 Hz ~ +200 Hz (10 Hz/steps) | 0 Hz |
| MODE-SSB | 066 J3E USB CAR | -200 Hz ~ +200 Hz (10 Hz/steps) | 0 Hz |
| RX GENERAL | 067 RGEN NB 1 LVL | 0 ~ 255 | 128 |
| RX GENERAL | 068 RGEN NB 2 LVL | 0 ~ 255 | 128 |
| RX GENERAL | 069 RGEN CNTR LV | -40 ~ +20 dB | -15 dB |
| RX GENERAL | 070 RGEN CNTR WI | 1 ~ 11 | 10 |
| RX GENERAL | 071 RGEN DNF | OFF/On | OFF |
| RX GENERAL | 072 RGEN DNR | OFF/1 ~ 15 | OFF |
| SCOPE | 073 SCP 1.8 FIX | 1.800 ~ 1.999 MHz (1 kHz/steps) | 1.800 MHz ^{*1} |
| SCOPE | 074 SCP 3.5 FIX | 3.500 ~ 3.999 MHz (1 kHz/steps) | 3.500 MHz ^{*1} |
| SCOPE | 075 SCP 5.2 FIX | 5.250 ~ 5.499 MHz (1 kHz/steps) | 5.250 MHz ^{*1} |
| SCOPE | 076 SCP 7.0 FIX | 7.000 ~ 7.299 MHz (1 kHz/steps) | 7.000 MHz ^{*1} |
| SCOPE | 077 SCP 10.1 FIX | (1)0.100 ~ (1)0.149 MHz (1 kHz/steps) | (1)0.100 MHz ^{*1} |
| SCOPE | 078 SCP 14.0 FIX | (1)4.000 ~ (1)4.349 MHz (1 kHz/steps) | (1)4.000 MHz ^{*1} |
| SCOPE | 079 SCP 18.0 FIX | (1)8.000 ~ (1)8.199 MHz (1 kHz/steps) | (1)8.068 MHz ^{*1} |
| SCOPE | 080 SCP 21.0 FIX | (2)1.000 ~ (2)1.449 MHz (1 kHz/steps) | (2)1.000 MHz ^{*1} |
| SCOPE | 081 SCP 24.8 FIX | (2)4.800 ~ (2)4.989 MHz (1 kHz/steps) | (2)4.890 MHz ^{*1} |
| SCOPE | 082 SCP 28.0 FIX | (2)8.000 ~ (2)9.699 MHz (1 kHz/steps) | (2)8.000 MHz ^{*1} |
| SCOPE | 083 SCP 50.0 FIX | (5)0.000 ~ (5)3.999 MHz (1 kHz/steps) | (5)0.000 MHz ^{*1} |
| TUNING | 084 TUN DIALSTP | 1/5/10 Hz | 10 Hz |
| TUNING | 085 TUN CW FINE | EnA/diS (ENABLE/DISABLE) | diS (DISABLE) |
| TUNING | 086 TUN MHz SEL | 1/0.1 MHz | 1 MHz |
| TUNING | 087 TUN AM STEP | 2.5/5/9/10/12.5 kHz | 5 kHz |
| TUNING | 088 TUN FM STEP | 5/6.25/10/12.5/20/25 kHz | 5 kHz |
| TUNING | 089 TUN FM DIAL | 10/100 Hz | 100 Hz |
| TUNING | 090 TUN MY BAND | 1.8 ~ 50/GE | - |

※1: Requires optional **DMU-2000** Data Management Unit.

MENU MODE

| GROUP | No. MENU FUNCTION | AVAILABLE VALUES | DEFAULT SETTING |
|------------|-------------------|---|----------------------|
| TX AUDIO | 091 TAUD EQ1 FRQ | OFF/100 ~ 700 Hz (100 Hz/step) | OFF |
| TX AUDIO | 092 TAUD EQ1 LVL | -20 ~ +10 | +5 |
| TX AUDIO | 093 TAUD EQ1 BW | 1 ~ 10 | 10 |
| TX AUDIO | 094 TAUD EQ2 FRQ | OFF/700 ~ 1500 Hz (100 Hz/step) | OFF |
| TX AUDIO | 095 TAUD EQ2 LVL | -20 ~ +10 | +5 |
| TX AUDIO | 096 TAUD EQ2 BW | 1 ~ 10 | 10 |
| TX AUDIO | 097 TAUD EQ3 FRQ | OFF/1500 ~ 3200 Hz (100 Hz/step) | OFF |
| TX AUDIO | 098 TAUD EQ3 LVL | -20 ~ +10 | +5 |
| TX AUDIO | 099 TAUD EQ3 BW | 1 ~ 10 | 10 |
| TX AUDIO | 100 TAUD PE1 FRQ | OFF/100 ~ 700 Hz (100 Hz/step) | 200 Hz |
| TX AUDIO | 101 TAUD PE1 LVL | -20 ~ +10 | 0 |
| TX AUDIO | 102 TAUD PE1 BW | 1 ~ 10 | 2 |
| TX AUDIO | 103 TAUD PE2 FRQ | OFF/700 ~ 1500 Hz (100 Hz/step) | 800 Hz |
| TX AUDIO | 104 TAUD PE2 LVL | -20 ~ +10 | 0 |
| TX AUDIO | 105 TAUD PE2 BW | 1 ~ 10 | 1 |
| TX AUDIO | 106 TAUD PE3 FRQ | OFF/1500 ~ 3200 Hz (100 Hz/step) | 2100 Hz |
| TX AUDIO | 107 TAUD PE3 LVL | -20 ~ +10 | 0 |
| TX AUDIO | 108 TAUD PE3 BW | 1 ~ 10 | 1 |
| TX GENERAL | 109 TGEN PROCLVL | 1 ~ 100 | 50 |
| TX GENERAL | 110 TGEN EXT TUN | itu/Etu (INTERNAL TUNER/EXTERNAL TUNER) | itu (INTERNAL TUNER) |
| TX GENERAL | 111 TGEN TX PWR | 5 ~ 100 | 100 |
| TX GENERAL | 112 TGEN AM CAR | 0 ~ 100 | 50 |
| TX GENERAL | 113 TGEN PWRCTRL | ALL/CAR | ALL |
| TX GENERAL | 114 TGEN VOX SEL | nic/dAtA | nic |
| TX GENERAL | 115 TGEN V GAIN | 0 ~ 100 | 50 |
| TX GENERAL | 116 TGEN VOX DLY | 30 ~ 3000 msec (10 msec/step) | 500 msec |
| TX GENERAL | 117 TGEN ANTIVOX | 0 ~ 100 | 50 |
| TX GENERAL | 118 TGEN EMRGNCY | EnA/diS (ENABLE/DISABLE) | diS(DISABLE) |

AGC GROUP

001 AGC FST DLY

Function: Sets the delay time for the AGC FAST mode.

Available Values: 20 ~ 4000 msec (20 msec/step)

Default Setting: 300 msec

002 AGC MID DLY

Function: Sets the delay time for the AGC MID mode.

Available Values: 20 ~ 4000 msec (20 msec/step)

Default Setting: 700 msec

003 AGC SLW DLY

Function: Sets the delay time for the AGC SLOW mode.

Available Values: 20 ~ 4000 msec (20 msec/step)

Default Setting: 3000 msec

DISPLAY GROUP

004 DISP COLOR

Function: Selects the Display color when the optional Data Management Unit (**DMU-2000**) is connected.

Available Values: bL1/bL2/bL3/ub1/ub2

Default Setting: bL1 (COOL BLUE)

bL1: COOL BLUE

bL2: CONTRAST BLUE

bL3: FLASH WHITE

ub1: CONTRAST UMBER

ub2: UMBER

ADVICE:

If the optional **DMU-2000** Data Management Unit is not connected, this adjustment has no effect.

005 DISP DIM VFD

Function: Setting of the display brightness level.

Available Values: 0 ~ 15

Default Setting: 8

006 DISP BAR SEL

Function: Selects one of three parameters to be viewed on the Tuning Offset Indicator.

Available Values: CLAr/C-tn/u-tn

Default Setting: C-tn

CLAr: Displays relative clarifier offset.

C-tn: Displays relative tuning offset between the incoming signal and transmitted frequency while in CW operation.

u-tn: Displays the peak position of the optional μ -TUNE filter.

007 DISP PKH S

Function: Selects the peak hold time of the S-meter.

Available Values: OFF/0.5/1.0/2.0 sec

Default Setting: OFF

008 DISP PKH PO

Function: Selects the peak hold time of the PO meter.

Available Values: OFF/0.5/1.0/2.0 sec

Default Setting: OFF

009 DISP PKH ALC

Function: Selects the peak hold time of the ALC meter.

Available Values: OFF/0.5/1.0/2.0 sec

Default Setting: OFF

010 DISP PKH ID

Function: Selects the peak hold time of the ID meter.

Available Values: OFF/0.5/1.0/2.0 sec

Default Setting: OFF

DISPLAY GROUP

011 DISP RTR STU

Function: Selects the starting point of your rotator controller's indicator needle.

Available Values: 0/90/180/270°

Default Setting: 0°

ADVICE:

If the optional Antenna Rotator is not connected, this adjustment has no effect.

012 DISP RTR ADJ

Function: Adjusts the indicator needle precisely to the starting point set in menu item "011 DISP RTR STU".

Available Values: -30 ~ 0° (2°/step)

Default Setting: 0

ADVICE:

If the optional Antenna Rotator is not connected, this adjustment has no effect.

013 DISP QMB MKR

Function: Enables/Disables the QMB Marker (White arrow "▽") to display on the Spectrum Band Scope when the optional **DMU-2000** Data Management Unit is connected.

Available Values: On/OFF

Default Setting: On

ADVICE:

If the optional **DMU-2000** Data Management Unit is not connected, this adjustment has no effect.

DVS GROUP

014 DVS RX LVL

Function: Sets the audio output level from the optional **DVS-6** Voice Memory Unit.

Available Values: 0 ~ 100

Default: 50

ADVICE:

If the optional **DVS-6** Voice Memory Unit is not connected, this adjustment has no effect.

015 DVS TX LVL

Function: Sets the microphone input level to the optional **DVS-6** Voice Memory Unit

Available Values: 0 ~ 100

Default: 50

ADVICE:

If the optional **DVS-6** Voice Memory Unit is not connected, this adjustment has no effect.

KEYER GROUP

016 KEY BEACON

Function: Sets the interval time between repeats of the beacon message.

Available Values: OFF/1 ~ 240 sec (1 sec/step)/270 ~ 690 sec (30 sec/step)

Default Setting: OFF

017 KEY NUM STL

Function: Selects the Contest Number "Cut" format for an imbedded contest number.

Available Values: 1290/AunO/Aunt/A2nO/A2nt/12nO/12nt

Default Setting: 1290

1290: Does not abbreviate the Contest Number

AunO: Abbreviates to "A" for "One", "U" for "Two", "N" for "Nine", and "O" for "Zero."

Aunt: Abbreviates to "A" for "One", "U" for "Two", "N" for "Nine", and "T" for "Zero".

A2nO: Abbreviates to "A" for "One", "N" for "Nine", and "O" for "Zero".

A2nt: Abbreviates to "A" for "One", "N" for "Nine", and "T" for "Zero".

12nO: Abbreviates to "N" for "Nine" and "O" for "Zero".

12nt: Abbreviates to "N" for "Nine" and "T" for "Zero".

018 KEY CONTEST

Function: Enters the initial contest number that will increment/decrement after sending during contest QSOs.

Available Values: 0 ~ 9999

Default Setting: 1

ADVICE:

Press the [CLEAR] button to reset the contest number to "1".

KEYER GROUP

019 KEY CW MEM1

Function: Permits entry of the CW message for message register 1.

Available Values: tyP1/tyP2

Default Setting: tyP2

tyP1: You may enter the CW message from the Main Tuning Dial knob and [CLAR/VFO-B] knob.

tyP2: You may enter the CW message from the CW keyer.

020 KEY CW MEM2

Function: Permits entry of the CW message for message register 2.

Available Values: tyP1/tyP2

Default Setting: tyP2

tyP1: You may enter the CW message from the Main Tuning Dial knob and [CLAR/VFO-B] knob.

tyP2: You may enter the CW message from the CW keyer.

021 KEY CW MEM3

Function: Permits entry of the CW message for message register 3.

Available Values: tyP1/tyP2

Default Setting: tyP2

tyP1: You may enter the CW message from the Main Tuning Dial knob and [CLAR/VFO-B] knob.

tyP2: You may enter the CW message from the CW keyer.

022 KEY CW MEM4

Function: Permits entry of the CW message for message register 4.

Available Values: tyP1/tyP2

Default Setting: tyP2

tyP1: You may enter the CW message from the Main Tuning Dial knob and [CLAR/VFO-B] knob.

tyP2: You may enter the CW message from the CW keyer.

023 KEY CW MEM5

Function: Permits entry of the CW message for message register 5.

Available Values: tyP1/tyP2

Default Setting: tyP2

tyP1: You may enter the CW message from the Main Tuning Dial knob and [CLAR/VFO-B] knob.

tyP2: You may enter the CW message from the CW keyer.

GENERAL GROUP

024 GENE ANT SEL

Function: Sets the method of antenna selection.

Available Values: bAnd/rEG

Default Setting: bAnd

bAnd: The antenna is selected in accordance with the operating band.

rEG: The antenna is selected in accordance with the band stack (different antennas may be utilized on the same band, if so selected in the band stack).

025 GENE BEP LVL

Function: Sets the beep level.

Available Values: 0 ~ 100

Default Setting: 50

026 GENE CAT BPS

Function: Sets the transceiver's computer-interface circuitry for the CAT baud rate to be used.

Available Values: 4800/9600/192H (19200)/384H (38400) bps

Default Setting: 4800 bps

027 GENE CAT TOT

Function: Sets the Time-Out Timer countdown time for a CAT command input.

Available Values: 10/100/1000/3000 msec

Default Setting: 10 msec

The Time-Out Timer shuts off the CAT data input after the continuous transmission of the programmed time.

028 GENE CAT RTS

Function: Enables/Disables the RTS port of the CAT jack.

Available Values: On/OFF

Default Setting: On

029 GENE MEM GRP

Function: Enables/Disables Memory Group Operation.

Available Values: On/OFF

Default Setting: OFF

030 GENE Q SPLIT

Function: Selects the tuning offset for the Quick Split feature.

Available Values: -20 ~ 0 ~ +20 kHz (1 kHz Step)

Default Setting: +5 kHz

031 GENE TX TOT

Function: Sets the Time-Out Timer countdown time.

Available Values: OFF/1 ~ 30 min

Default Setting: OFF

The Time-Out Timer shuts off the transmitter after continuous transmission of the programmed time.

GENERAL GROUP

032 GENE μ T DIAL

Function: Selects the μ -TUNE mode.

Available Values: StP1/StP2

Default Setting: StP1

StP1: Activates the μ -TUNE system using “COARSE” steps of the [SELECT(μ -TUNE)] knob (2 steps/click) on the 7 MHz and lower amateur bands. On the 10/14 MHz bands, “FINE” [SELECT(μ -TUNE)] knob steps will be used (1 step/click).

StP2: Activates the μ -TUNE system using “FINE” steps of the [SELECT(μ -TUNE)] knob (1 step/click) on the 14 MHz and lower amateur bands.

ADVICE:

If an optional RF μ Tuning Kit is not connected, this adjustment has no effect.

033 GENE MIC SCN

Function: Enables/disables scanning access via the microphone’s [UP]/[DWN] keys.

Available Values: On/OFF

Default Setting: On

034 GENE SCN RSM

Function: Selects the Scan Resume mode.

Available Values: CAR/5SEc

Default Setting: 5SEc

CAR: The scanner will hold until the signal disappears, then will resume after one second.

5SEc: The scanner will hold for five seconds, then resume whether or not the other station is still transmitting.

035 GENE FRQ ADJ

Function: Adjusts the reference oscillator.

Available Values: -25 ~ 0 ~ +25

Default Setting: 0

Connect a 50-Ohm dummy load and frequency counter to the antenna jack; adjust the [CLAR/VFO-B] knob so that the frequency counter reading is same as the VFO frequency while pressing the PTT switch.

ADVICE:

Do not perform this Menu item unless you have a high performance frequency counter. Perform this Menu item after aging the transceiver and frequency counter sufficiently (at least 30 minutes).

MODE-AM GROUP

036 A3E MICGAIN

Function: Sets the microphone gain for the AM mode.

Available Values: Ur/0 ~ 100

Default Setting: Ur

When this menu is set to “Ur”, you may adjust the microphone gain using the front panel’s [MIC GAIN] knob.

MODE-CW GROUP

037 A1A F-TYPE

Function: Selects the desired keyer operation mode for the device connected to the front panel’s KEY jack.

Available Values: OFF/buG/ELE/ACS

Default Setting: ELE

OFF: Disables the front panel’s keyer (“straight key” mode for use with external keyer or computer-driven keying interface).

buG: Mechanical “bug” keyer emulation. One paddle produces “dits” automatically, while the other paddle manually produces “dahs”.

ELE: Iambic keyer with ACS (Automatic Character Spacing) disabled.

ACS: Iambic keyer with ACS (Automatic Character Spacing) enabled.

038 A1A F-REV

Function: Selects the keyer paddle’s wiring configuration for the KEY jack on the front panel.

Available Values: nor/rEV

Default Setting: nor

nor: Tip = Dot, Ring = Dash, Shaft = Ground

rEV: Tip = Dash, Ring = Dot, Shaft = Ground

039 A1A R-TYPE

Function: Selects the desired keyer operation mode for the device connected to the rear panel’s KEY jack.

Available Values: OFF/buG/ELE/ACS

Default Setting: ELE

OFF: Disables the front panel’s keyer (“straight key” mode for use with external keyer or computer-driven keying interface).

buG: Mechanical “bug” keyer emulation. One paddle produces “dits” automatically, while the other paddle manually produces “dahs”.

ELE: Iambic keyer with ACS (Automatic Character Spacing) disabled.

ACS: Iambic keyer with ACS (Automatic Character Spacing) enabled.

040 A1A R-REV

Function: Selects the keyer paddle’s wiring configuration for the KEY jack on the rear panel.

Available Values: nor/rEV

Default Setting: nor

nor: Tip = Dot, Ring = Dash, Shaft = Ground

rEV: Tip = Dash, Ring = Dot, Shaft = Ground

MODE-CW GROUP

041 A1A CW AUTO

Function: Enables/disables CW keying while operating on SSB.

Available Values: OFF/50/On

Default Setting: OFF

OFF: Disables CW keying while operating on SSB.

50: Enables CW keying only while operating SSB on 50 MHz (but not HF).

On: Enables CW keying while operating on SSB (all TX bands).

NOTE:

This feature allows you to move someone from SSB to CW without having to change modes on the front panel.

042 A1A BFO

Function: Sets the CW carrier oscillator injection side for the CW mode.

Available Values: USB/LSb/Auto

Default Setting: USB

USB: Injects the CW carrier oscillator on the USB side.

LSb: Injects the CW carrier oscillator on the LSB side.

Auto: Injects the CW carrier oscillator on the LSB side while operating on the 7 MHz band and below, and the USB side while operating on the 10 MHz band and up.

043 A1A BK-IN

Function: Sets the CW “break-in” mode.

Available Values: SEni/FuLL

Default Setting: SEni

SEni (SEMI): The transceiver will operate in the semi break-in mode. The delay (receiver recovery) time is set via the Menu item “044 A1A DELAY”.

FuLL: The transceiver will operate in the full break-in (QSK) mode.

044 A1A DELAY

Function: Adjusts the Keying Delay (receiver recovery) time on the CW mode.

Available Values: 30 ~ 3000 msec (10 msec/step)

Default Setting: 200 msec

045 A1A PITCH

Function: Adjusts your preferred CW tone pitch.

Available Values: 300 ~ 1050 Hz (50 Hz/step)

Default Setting: 700 Hz

046 A1A WEIGHT

Function: Sets the Dot:Dash ratio for the built-in electronic keyer.

Available Values: (1:) 2.5 ~ 4.5

Default Setting: 3.0

047 A1A FRQDISP

Function: Selects the frequency Display Format for the CW mode.

Available Values: dir/OFSt

Default Setting: OFSt

dir (Direct Frequency): Displays the receiver carrier frequency, without any offset added. When changing modes between SSB and CW, the frequency display remains constant.

OFSt (Pitch Offset): This frequency display reflects the added BFO offset.

048 A1A PC KYNG

Function: Enables/disables CW keying from the “DATA PTT” terminal (pin 3) on the rear panel’s RTTY/PKT jack while operating on the CW mode.

Available Values: EnA (Enable)/diS (Disable)

Default Setting: diS (Disable)

049 A1A QSKTIME

Function: Selects the time delay between when the PTT is keyed and the carrier is transmitted during QSK operation when using the internal keyer.

Available Values: 15/20/25/30 msec

Default Setting: 15 msec

MODE-DATA GROUP

050 DATA DT GAIN

Function: Sets the data input level from the TNC to the AFSK modulator.

Available Values: 0 ~ 100

Default Setting: 50

051 DATA OUT LVL

Function: Sets the AFSK data output level at the output port (pin 5) of the **RTTY/PKT** jack.

Available Values: 0 ~ 100

Default Setting: 50

052 DATA VOX DLY

Function: Adjusts the “VOX” Delay (receiver recovery) time in the PACKET mode.

Available Values: 30 ~ 3000 msec (10 msec/step)

Default Setting: 300 msec

053 DATA V GAIN

Function: Adjusts the “VOX” Gain in the PACKET mode.

Available Values: 0 ~ 100

Default Setting: 50

054 DATA PKTDISP

Function: Sets the packet frequency display offset.

Available Values: -3000 ~ +3000 Hz (10 Hz/step)

Default: 0 Hz

055 DATA PKT SFT

Function: Sets the carrier point during the SSB packet operation.

Available Values: -3000 ~ +3000 Hz (10 Hz/step)

Default: 1000 Hz (typical center frequency for PSK31, etc.)

MODE-FM GROUP

056 F3E MIC

Function: Sets the microphone gain for the FM mode.

Available Values: Ur/0 ~ 100

Default Setting: 50

When this menu is set to “Ur”, you may adjust the microphone gain using the front panel’s **[MIC GAIN]** knob.

057 F3E 28 RPT

Function: Sets the magnitude of the repeater shift on the 28 MHz band.

Available Values: 0 ~ 1000 kHz (10 kHz/step)

Default Setting: 100 kHz

058 F3E 50 RPT

Function: Sets the magnitude of the repeater shift on the 50 MHz band.

Available Values: 0 ~ 4000 kHz (10 kHz/step)

Default Setting: 1000 kHz

MODE-RTTY GROUP

059 RTTY R PLRTY

Function: Selects normal or reverse Mark/Space polarity for RTTY receive operation.

Available Values: nor/rEV

Default Setting: nor

060 RTTY T PLRTY

Function: Selects normal or reverse Mark/Space polarity for RTTY transmit operation.

Available Values: nor/rEV

Default Setting: nor

061 RTTY OUT LVL

Function: Sets the RTTY (AFSK) data output level at the output port (pin 5) of the **RTTY/PKT** jack.

Available Values: 0 ~ 100

Default Setting: 50

062 RTTY SHIFT

Function: Selects the frequency shift for RTTY (AFSK) operation.

Available Values: 170/200/425/850 Hz

Default Setting: 170 Hz

063 RTTY TONE

Function: Selects the Mark tone for RTTY operation.

Available Values: 1275/2125 Hz

Default Setting: 2125 Hz

MODE-SSB GROUP

064 J3E TX BPF

Function: Selects the audio passband of the DSP modulator on the SSB mode.

Available Values: 1-30/1-29/2-28/3-27/4-26

Default Setting: 3-27: 300 ~ 2700 (Hz)

1-30: 100 ~ 3000 (Hz)

1-29: 100 ~ 2900 (Hz)

2-28: 200 ~ 2800 (Hz)

3-27: 300 ~ 2700 (Hz)

4-26: 400 ~ 2600 (Hz)

NOTE:

The *apparent* power output, when using the widest bandwidths, may seem lower. This is normal, and it occurs because the available transmitter power is distributed over a wider bandwidth. The greatest compression of power output, conversely, occurs when using the “4-26” setting (400 ~ 2600 Hz), and this setting is highly recommended for contest or DX pile-up work.

065 J3E LSB CAR

Function: Adjusts the receiver carrier point for the LSB mode.

Available Values: -200 Hz ~ +200 Hz (10 Hz steps)

Default Setting: 0 Hz

066 J3E USB CAR

Function: Adjusts the receiver carrier point for the USB mode.

Available Values: -200 Hz ~ +200 Hz (10 Hz steps)

Default Setting: 0 Hz

RX GENERAL GROUP

067 RGEN NB 1 LVL

Function: Adjusts the noise blanking level of the IF Noise Blanker for short duration pulse noise.

Available Values: 0 ~ 255

Default Setting: 128

068 RGEN NB 2 LVL

Function: Adjusts the noise blanking level of the IF Noise Blanker for longer duration pulse noise.

Available Values: 0 ~ 255

Default Setting: 128

069 RGEN CNTR LV

Function: Adjusts the parametric equalizer gain of the Contour filter.

Available Values: -40 ~ +20 dB

Default Setting: -15 dB

070 RGEN CNTR WI

Function: Adjusts the Q-factor of the Contour filter.

Available Values: 1 ~ 11

Default Setting: 10

071 RGEN DNF

Function: Enables/disables the Digital Notch Filter.

Available Values: OFF/On

Default Setting: OFF

072 RGEN DNR

Function: Set the Digital Noise Reduction response.

Available Values: OFF/1 ~ 15

Default Setting: OFF

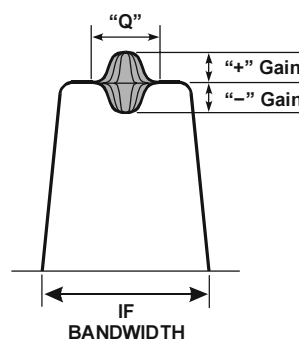

CONTOUR “GAIN” AND “Q”

SCOPE GROUP

ADVICE:

This group's adjustment has no effect if the optional **DMU-2000** Data Management Unit is not connected.

073 SCP 1.8 FIX

Function: Selects the scan start frequency of the FIX mode Spectrum Scope while monitoring on the 160 m amateur band.

Available Values: 1.800 ~ 1.999 MHz (1 kHz steps)

Default Setting: 1.800 MHz

074 SCP 3.5 FIX

Function: Selects the scan start frequency of the FIX mode Spectrum Scope while monitoring on the 80 m amateur band.

Available Values: 3.500 ~ 3.999 MHz (1 kHz steps)

Default Setting: 3.500 MHz

075 SCP 5.2 FIX

Function: Selects the scan start frequency of the FIX mode Spectrum Scope while monitoring on the 60 m amateur band.

Available Values: 5.250 ~ 5.499 MHz (1 kHz steps)

Default Setting: 5.250 MHz

076 SCP 7.0 FIX

Function: Selects the scan start frequency of the FIX mode Spectrum Scope while monitoring on the 40 m amateur band.

Available Values: 7.000 ~ 7.299 MHz (1 kHz steps)

Default Setting: 7.000 MHz

077 SCP 10.1 FIX

Function: Selects the scan start frequency of the FIX mode Spectrum Scope while monitoring on the 30 m amateur band.

Available Values: (1)0.100 ~ (1)0.149 MHz (1 kHz steps)

Default Setting: (1)0.100 MHz

078 SCP 14.0 FIX

Function: Selects the scan start frequency of the FIX mode Spectrum Scope while monitoring on the 20 m amateur band.

Available Values: (1)4.000 ~ (1)4.349 MHz (1 kHz steps)

Default Setting: (1)4.000 MHz

079 SCP 18.0 FIX

Function: Selects the scan start frequency of the FIX mode Spectrum Scope while monitoring on the 17 m amateur band.

Available Values: (1)8.000 ~ (1)8.199 MHz (1 kHz steps)

Default Setting: (1)8.068 MHz

080 SCP 21.0 FIX

Function: Selects the scan start frequency of the FIX mode Spectrum Scope while monitoring on the 15 m amateur band.

Available Values: (2)1.000 ~ (2)1.449 MHz (1 kHz steps)

Default Setting: (2)1.000 MHz

081 SCP 24.8 FIX

Function: Selects the scan start frequency of the FIX mode Spectrum Scope while monitoring on the 12 m amateur band.

Available Values: (2)4.800 - (2)4.989 MHz (1 kHz steps)

Default Setting: (2)4.890 MHz

082 SCP 28.0 FIX

Function: Selects the scan start frequency of the FIX mode Spectrum Scope while monitoring on the 10 m amateur band.

Available Values: (2)8.000 ~ (2)9.699 MHz (1 kHz steps)

Default Setting: (2)8.000 MHz

083 SCP 50.0 FIX

Function: Selects the scan start frequency of the FIX mode Spectrum Scope while monitoring on the 6 m amateur band.

Available Values: (5)0.000 ~ (5)3.999 MHz (1 kHz steps)

Default Setting: (5)0.000 MHz

MENU MODE

TUNING GROUP

084 TUN DIALSTP

Function: Setting of the Main Tuning Dial knob's and the [CLAR/VFO-B] knob's tuning speed on the SSB, CW, and AM modes.

Available Values: 1/5/10 Hz

Default Setting: 10 Hz

085 TUN CW FINE

Function: Enabling/disabling of the "Fine" tuning speed in the CW mode.

Available Values: EnA/diS (ENABLE/DISABLE)

Default Setting: diS (DISABLE)

EnA (ENABLE): Tuning in 1 Hz steps on the CW mode.

diS (DISABLE): Tuning according to the steps determined via menu item "084 TUN DIALSTP".

086 TUN MHz SEL

Function: Selects the tuning steps for the [CLAR/VFO-B] knob when the [MHz] button is pressed.

Available Values: 1/0.1 MHz

Default Setting: 1 MHz

087 TUN AM STEP

Function: Selects the tuning steps for the microphone's [UP]/[DWN] keys in the AM mode.

Available Values: 2.5/5/9/10/12.5 kHz

Default Setting: 5 kHz

088 TUN FM STEP

Function: Selects the tuning steps for the microphone's [UP]/[DWN] keys in the FM mode.

Available Values: 5/6.25/10/12.5/20/25 kHz

Default Setting: 5 kHz

089 TUN FM DIAL

Function: Setting of the Main Tuning Dial knob's and the [CLAR/VFO-B] knob's tuning speed in the FM mode.

Available Values: 10/100 Hz

Default Setting: 100 Hz

090 TUN MY BAND

Function: Programs a band to be skipped while selecting bands using the [CLAR/VFO-B] knob.

To program the band to be skipped, rotate the [CLAR/VFO-B] knob to recall the band to be skipped while selecting bands via the [CLAR/VFO-B] knob, then press the [ENT] button to change this setting to "ON" (a "d" notation will replace the "E" notation). Repeat the same procedure to cancel the setting (skipped "Off": "d" notation appears).

TX AUDIO GROUP

091 TAUD EQ1 FRQ

Function: Selects the center frequency of the lower range for the parametric microphone equalizer.

Available Values: OFF/100 ~ 700 Hz (100 Hz/step)

Default Setting: OFF

OFF: The equalizer gain and Q-factor are set to factory defaults (flat).

100 ~ 700: Center frequencies of 100 Hz ~ 700 Hz.

You may adjust the equalizer gain and Q-factor at this selected audio frequency via menu items "092 TAUD EQ1 LVL" and "093 TAUD EQ1 BW".

092 TAUD EQ1 LVL

Function: Adjusts the equalizer gain of the low range of the parametric microphone equalizer.

Available Values: -20 ~ +10

Default Setting: +5

093 TAUD EQ1 BW

Function: Adjusts the Q-factor of the low range of the parametric microphone equalizer.

Available Values: 1 ~ 10

Default Setting: 10

094 TAUD EQ2 FRQ

Function: Selects the center frequency of the middle range for the parametric microphone equalizer.

Available Values: OFF/700 ~ 1500 Hz (100 Hz/step)

Default Setting: OFF

OFF: The equalizer gain and Q-factor are set to factory defaults (flat).

700 ~ 1500: Center frequencies of 700 Hz ~ 1500 Hz.

You may adjust the equalizer gain and Q-factor at this selected audio frequency via menu items "095 TAUD EQ2 LVL" and "096 TAUD EQ2 BW".

095 TAUD EQ2 LVL

Function: Adjusts the equalizer gain of the middle range of the parametric microphone equalizer.

Available Values: -20 ~ +10

Default Setting: +5

096 TAUD EQ2 BW

Function: Adjusts the Q-factor of the middle range of the parametric microphone equalizer.

Available Values: 1 ~ 10

Default Setting: 10

TX AUDIO GROUP

097 TAUD EQ3 FRQ

Function: Selects the center frequency of the high range for the parametric microphone equalizer.

Available Values: OFF/1500 ~ 3200 Hz (100 Hz/step)

Default Setting: OFF

OFF: The equalizer gain and Q-factor are set to factory defaults (flat).

1500 ~ 3200: Center frequencies of 1500 Hz ~ 3200 Hz. You may adjust the equalizer gain and Q-factor in this selected audio frequency via menu items “098 TAUD EQ3 LVL” and “099 TAUD EQ3 BW”.

098 TAUD EQ3 LVL

Function: Adjusts the equalizer gain of the high range of the parametric microphone equalizer.

Available Values: -20 ~ +10

Default Setting: +5

099 TAUD EQ3 BW

Function: Adjusts the Q-factor of the high range of the parametric microphone equalizer.

Available Values: 1 ~ 10

Default Setting: 10

100 TAUD PE1 FRQ

Function: Selects the center frequency of the lower range for the parametric microphone equalizer when the speech processor is activated.

Available Values: OFF/100 ~ 700 Hz (100 Hz/step)

Default Setting: 200 Hz

OFF: The equalizer gain and Q-factor are set to factory defaults (flat).

100 ~ 700: Center frequencies of 100 Hz ~ 700 Hz.

You may adjust the equalizer gain and Q-factor at this selected audio frequency via menu items “101 TAUD PE1 LVL” and “102 TAUD PE1 BW”.

101 TAUD PE1 LVL

Function: Adjusts the equalizer gain of the low range of the parametric microphone equalizer when the speech processor is activated.

Available Values: -20 ~ +10

Default Setting: 0

102 TAUD PE1 BW

Function: Adjusts the Q-factor of the low range of the parametric microphone equalizer when the speech processor is activated.

Available Values: 1 ~ 10

Default Setting: 2

103 TAUD PE2 FRQ

Function: Selects the center frequency of the middle range for the parametric microphone equalizer when the speech processor is activated.

Available Values: OFF/700 ~ 1500 Hz (100 Hz/step)

Default Setting: 800 Hz

OFF: The equalizer gain and Q-factor are set to factory defaults (flat).

700 ~ 1500: Center frequencies of 700 Hz ~ 1500 Hz.

You may adjust the equalizer gain and Q-factor at this selected audio frequency via menu items “104 TAUD PE2 LVL” and “105 TAUD PE2 BW”.

104 TAUD PE2 LVL

Function: Adjusts the equalizer gain of the middle range of the parametric microphone equalizer when the speech processor is activated.

Available Values: -20 ~ +10

Default Setting: 0

105 TAUD PE2 BW

Function: Adjusts the Q-factor of the middle range of the parametric microphone equalizer when the speech processor is activated.

Available Values: 1 ~ 10

Default Setting: 1

106 TAUD PE3 FRQ

Function: Selects the center frequency of the high range for the parametric microphone equalizer when the speech processor is activated.

Available Values: OFF/1500 ~ 3200 Hz (100 Hz/step)

Default Setting: 2100 Hz

OFF: The equalizer gain and Q-factor are set to factory defaults (flat).

1500 ~ 3200: Center frequencies of 1500 Hz ~ 3200 Hz.

You may adjust the equalizer gain and Q-factor in this selected audio frequency via menu items “107 TAUD PE3 LVL” and “108 TAUD PE3 BW”.

107 TAUD PE3 LVL

Function: Adjusts the equalizer gain of the high range of the parametric microphone equalizer when the speech processor is activated.

Available Values: -20 ~ +10

Default Setting: 0

108 TAUD PE3 BW

Function: Adjusts the Q-factor of the high range of the parametric microphone equalizer when the speech processor is activated.

Available Values: 1 ~ 10

Default Setting: 1

TX GENERAL GROUP

109 TGEN PROCLVL

Function: Sets a compression level of the Speech Processor.

Available Values: 1 ~ 100

Default Setting: 50

110 TGEN EXT TUN

Function: Enable/disable the optional **FC-40** Antenna Tuner.

Available Values: itu/Etu (INTERNAL TUNER/EXTERNAL TUNER)

Default Setting: itu (INTERNAL)

itu (INTERNAL TUNER): The [**TUNE**] button will activate the internal Antenna Tuner.

Etu (EXTERNAL TUNER): The [**TUNE**] button will activate the optional **FC-40** Antenna Tuner.

111 TGEN TX PWR

Function: Sets a transmitter output level.

Available Values: 5 ~ 100 %

Default Setting: 100 %

112 TGEN AM CAR

Function: Sets a carrier power output level.

Available Values: 0 ~ 100

Default Setting: 50

113 TGEN PWRCTRL

Function: Setting the menu item “111 TGEN TX PWR”.

Available Values: ALL/CAR

Default Setting: ALL

ALL: The Menu Item “111 TGEN TX PWR” affects all modes except AM.

CAR: The Menu Item “111 TGEN TX PWR” affects all modes except SSB. In this case, the SSB output power will be set to maximum, regardless of the setting of the Menu Item “111 TGEN TX PWR”.

114 TGEN VOX SEL

Function: Selects the audio input source for triggering TX during VOX operation.

Available Values: nic/dAtA

Default Setting: nic

nic (MIC): The VOX function will be activated by microphone audio input.

dAtA (DATA): The VOX function will be activated by data audio input port (pin 1) of the **RTTY/PKT** Jack.

115 TGEN V GAIN

Function: Adjusts the “VOX” Gain on the SSB/AM/FM modes.

Available Values: 0 ~ 100

Default Setting: 50

116 TGEN VOX DLY

Function: Adjusts the “VOX” Delay (receiver recovery) time on the SSB/AM/FM modes.

Available Values: 30 ~ 3000 msec (10 msec/step)

Default Setting: 500 msec

117 TGEN ANTIVOX

Function: Adjusts the Anti-VOX Trip Gain, which is the level of negative AF feedback of receiver audio to the microphone, to prevent receiver audio from activating the transmitter (via the microphone) during VOX operation.

Available Values: 0 ~ 100

Default Setting: 50

118 TGEN EMRGNCY

Function: Enables Tx/Rx operation on the Alaska Emergency Channel, 5167.5 kHz.

Available Values: EnA(ENABLE)/diS(DISABLE)

Default Setting: diS(DISABLE)

When this Menu Item is set to “EnA(ENABLE),” the spot frequency of 5167.5 kHz will be enabled. The Alaska Emergency Channel will be found between the Memory channels “P-1” and “01 (or 1-01).”

Important: The use of this frequency is restricted to stations operating in or near Alaska, and only for emergency purposes (never for routine operations). See §97.401(c) of the FCC’s regulations for details.

INSTALLATION OF OPTIONAL ACCESSORIES

VOICE MEMORY UNIT (DVS-6)

The **DVS-6** Voice Memory Unit provides five memories capable of storing up to 20 seconds each of voice audio. You can store and then repeatedly transmit short identification and information messages.

Installation

1. Turn the **FT-950**'s **[POWER]** switch "off", and turn off the external DC power supply.
2. Disconnect all the cables from the **FT-950**.
3. Referring to Figure 1, remove the 18 screws attaching the bottom case, then remove the bottom case.
4. Refer to Figure 2 for the mounting location for the **DVS-6**.
5. Refer to Figure 3, push the **DVS-6** onto the pins corresponding to its assigned mounting location on the transceiver. Gently press the board down until it is firmly seated in its connectors.
6. Replace the bottom case and its 18 screws.
7. Connect the antenna and DC power supply to the **FT-950**.

Operation

Please see page 64 of this Operating Manual.

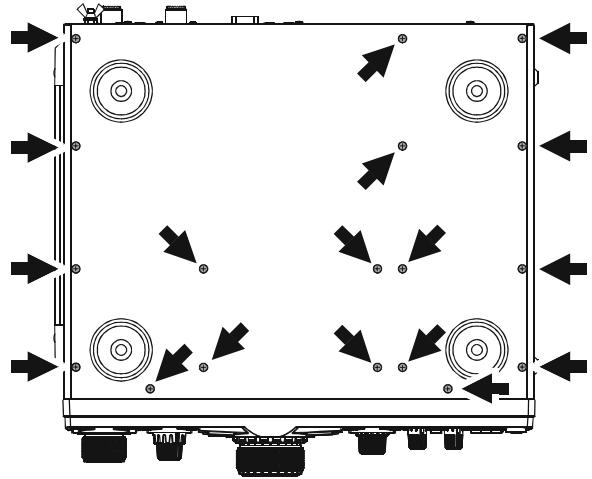

FIGURE 1

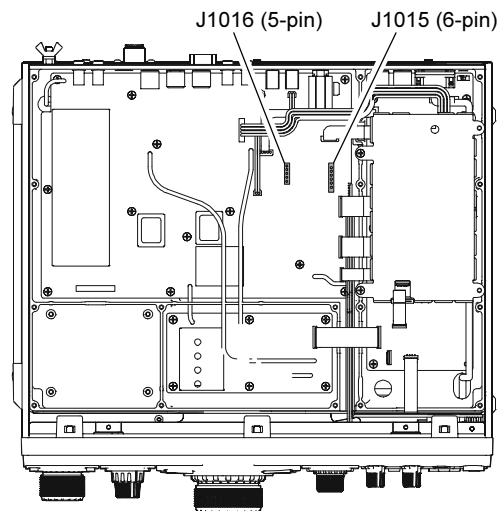

FIGURE 2

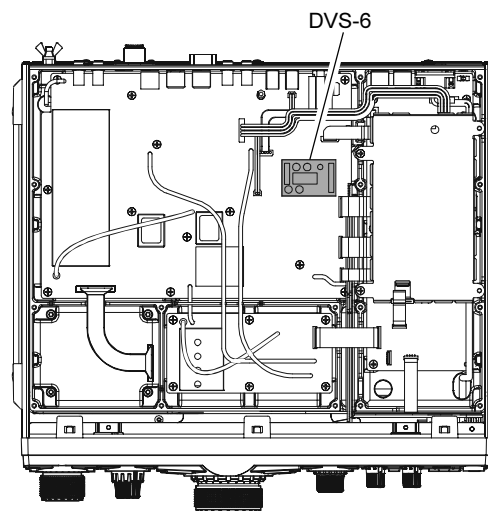

FIGURE 3

INSTALLATION OF OPTIONAL ACCESSORIES

RF μ TUNING KIT

The RF μ Tuning Kits provide ultra-sharp RF selectivity for the front end of the transceiver. Very high Q is made possible by the narrow-band design. Three RF μ Tuning Kits are available. The **MTU-160** covers the 1.8 MHz band. The **MTU-80/40** covers the 3.5 and 7 MHz bands. The **MTU-30/20** covers 10.1 and 14 MHz bands.

The narrow bandwidth is especially useful on the low bands, when many strong signals are being received via NVIS propagation (Near Vertical-Incidence Signals) within a narrow bandwidth. The added protection for the receiver RF stages is especially helpful in preventing IMD and blocking.

Installation

Assemble the RF μ Tuning Unit according to the “RF μ Tuning Kit Installation Manual” supplied with the RF μ Tuning Kit.

Interconnections to FT-950

Connect each cable (supplied with the RF μ Tuning Kit) between the RF μ Tuning Unit and the **FT-950** Transceiver.

Operation

Please see page 42 of this Operating Manual.

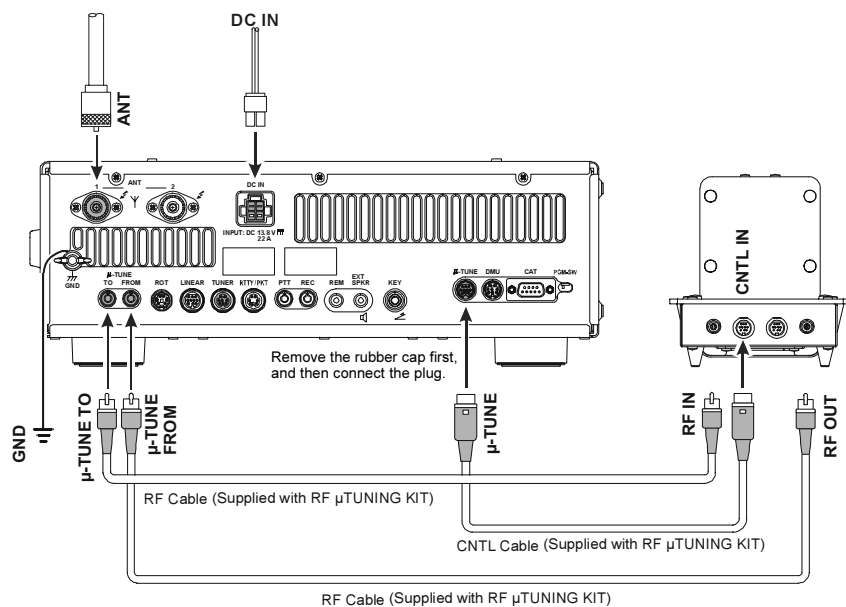

SINGLE CONNECTION

- ADVICE**
- The RF connecting cables are color coded (black and gray) to assist in properly connecting the **RF IN** and **RF OUT** jacks. (See illustration)
 - Miss-connection will not damage the RF μ Tuning Kit. However, improper operation may occur.
 - Connect the color-coded control cable(s) between the **CNTL OUT** and **CNTL IN** jacks (see illustration). Confirm all connections before turning on the transceiver.
 - If the **FT-950** does not operate and the frequency display blinks sometimes, confirm and correct the “**CNTL IN**” and “**CNTL OUT**” connections on the RF μ Tuning Unit.
 - The order of connecting multiple RF μ Tuning Units is not important.

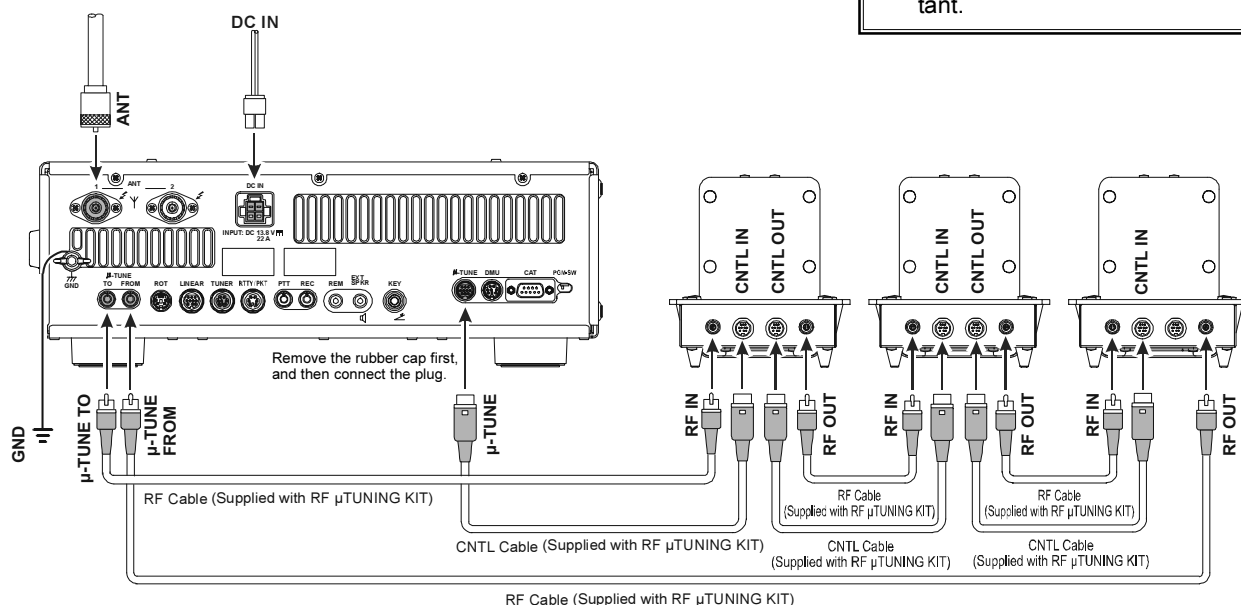

MULTI CONNECTION

INSTALLATION OF OPTIONAL ACCESSORIES

FC-40 EXTERNAL AUTOMATIC ANTENNA TUNER (FOR WIRE ANTENNA)

The **FC-40** makes use of the control circuitry built into the transceiver, which allows the operator to control and monitor automatic operation of the **FC-40**, which mounts near the antenna feedpoint. The **FC-40** uses specially selected, thermally stable components, and is housed in a waterproof case to withstand severe environmental conditions with high reliability.

A carefully-chosen combination of solid-state switching components and high-speed relays allows the **FC-40** to match a wide variety of antennas to within a 2:1 SWR on any amateur band frequency (160 through 6 meters), typically in less than eight seconds. Transmitter power required for matching may be as little as 4 - 60 Watts, and matching settings are automatically stored in memory for instant recall when the same frequency range is selected later.

Please see the **FC-40** Operating Manual for detailed information.

Interconnections to FT-950

After mounting the **FC-40**, connect the cables from the **FC-40** to the **ANT** and **TUNER** jacks on the rear panel of the **FT-950** Transceiver.

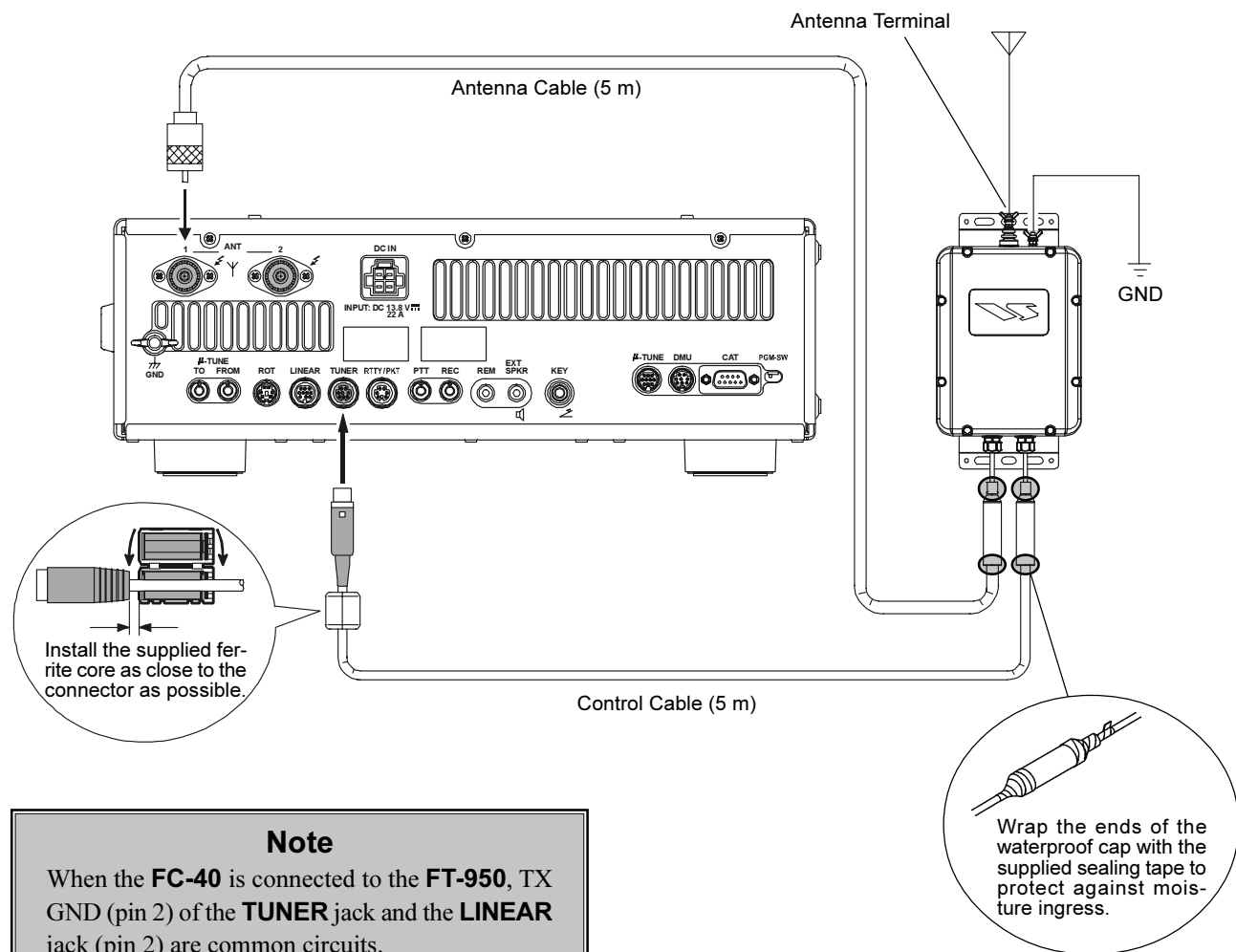

Note

When the **FC-40** is connected to the **FT-950**, TX GND (pin 2) of the **TUNER** jack and the **LINEAR** jack (pin 2) are common circuits.

Therefore, the maximum voltage at TX GND (pin 2) of the **LINEAR** jack must not exceed +5V.

INSTALLATION OF OPTIONAL ACCESSORIES

FC-40 EXTERNAL AUTOMATIC ANTENNA TUNER (FOR WIRE ANTENNA)

Setup the FT-950

The optional **FC-40** Automatic Antenna Tuner provides automatic tuning of a coaxial line to present nominal 50-ohm impedance to the **FT-950**'s **ANT** jack.

Before operation can begin, you must instruct the **FT-950**'s microprocessor that the **FC-40** is being used. This is done using the Menu Mode:

1. Press the **[MENU]** button momentarily, to engage the Menu mode.
2. Rotate the **[SELECT]** knob to select the Menu Item "110 TGEN EXT TUN".

ADVICE:

Press the **[SELECT]** knob momentarily to toggle the Menu item display between "110 TGEN" and "EXT TUN".

3. Rotate the **[CLAR/VFO-B]** knob to select "Etu (External Tuner)".
4. Press and hold in the **[MENU]** button for one second to save the new setting and exit to normal operation.

Operation

1. Press the **[TUNE]** button briefly to activate the Automatic Antenna Tuner.
2. The "**TUNER**" icon will appear in the display.
3. If the transceiver frequency is out of the amateur band, the "**TUNER**" icon will not appear.
4. Press and hold the **[TUNE]** button for one second to begin automatic tuning. The transmitter will be engaged, and the "**TUNER**" icon will blink while tuning is in progress.
5. Tuning will stop automatically when a low SWR is achieved. You may Press and hold the **[TUNE]** button for one second while tuning is in progress, to cancel the automatic tuning.
6. To disable the Automatic Antenna Tuner, press the **[TUNE]** button briefly again.

NOTE:

- Please connect a good earth ground to the **GND** terminal of **FC-40**.
- The carrier signal transmits continuously while tuning is in progress. Please monitor the operating frequency before beginning the tuning process. Be sure you are not interfering with others who may already be using the frequency.
- It is normal to hear the sound of the relays while tuning is in progress.
- If the impedance cannot be matched by the **FC-40** better than 2:1, and the "**TUNER**" icon blinks, the microprocessor will not retain the tuning data for that frequency, as the **FC-40** presumes that you will want to adjust or repair your antenna system to correct the high SWR condition.

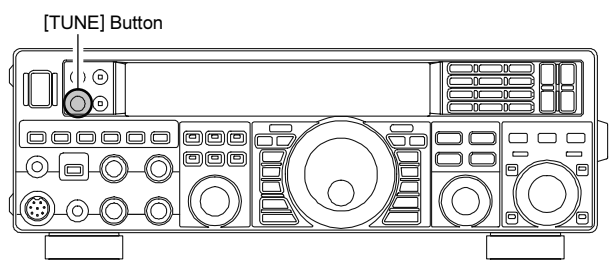
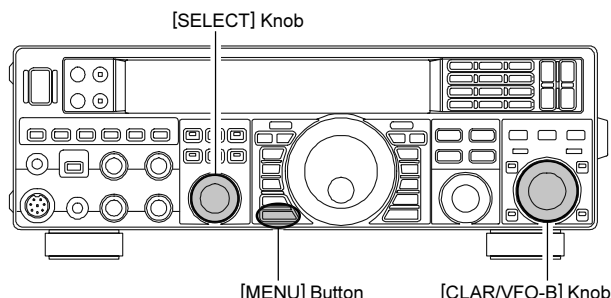

INSTALLATION OF OPTIONAL ACCESSORIES

DATA MANAGEMENT UNIT (DMU-2000)

The **DMU-2000** Data Management Unit provides a Band Scope, Audio Scope, X-Y Oscilloscope, World Clock, Rotator Control, extensive Transceiver Status Displays, and Station Logging Capability. These extensive functions are displayed on a user-supplied computer monitor.

Installation of the SCOPE Unit

1. Turn the **FT-950's** [POWER] switch "off", and turn off the external DC power supply.
2. Disconnect all the cables from the **FT-950**.
3. Referring to Figure 1, remove the 18 screws that attach the bottom case, then remove the bottom case.
4. Refer to Figure 2 for the mounting location of the SCOPE Unit. There is a disconnected 14-pin plug.
5. Mount the SCOPE Unit using the supplied four screws (Figure 3).
6. Referring to Figure 3, plug the 14-pin plug which was removed from the chassis in the previous step into the J7002 connector on the SCOPE Unit.
7. Locate the Coaxial plug (labeled ©) installed in jack (J4006) on the LOCAL Unit. Unplug the Coaxial plug (©) from the LOCAL Unit and plug it into the J7003 on the SCOPE Unit. Similarly, locate the Coaxial plug (labeled Ⓜ) installed in jack (J1029) on the MAIN Unit. Unplug the Coaxial plug (Ⓜ) from the MAIN Unit and plug it into the J7003 on the SCOPE Unit.
8. Referring to Figure 4, lay out the Coaxial cables into the slits of the chassis.
9. Replace the bottom case and its 18 screws.

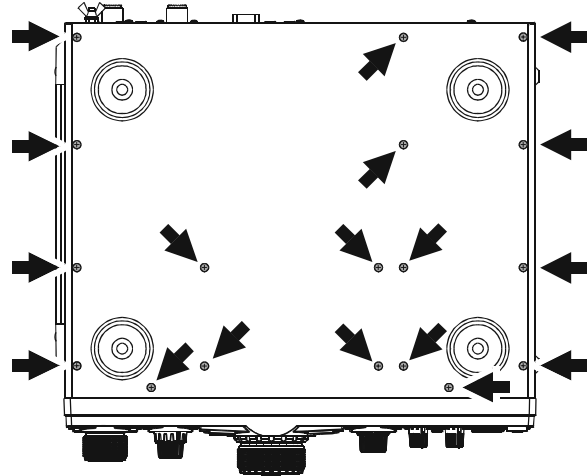
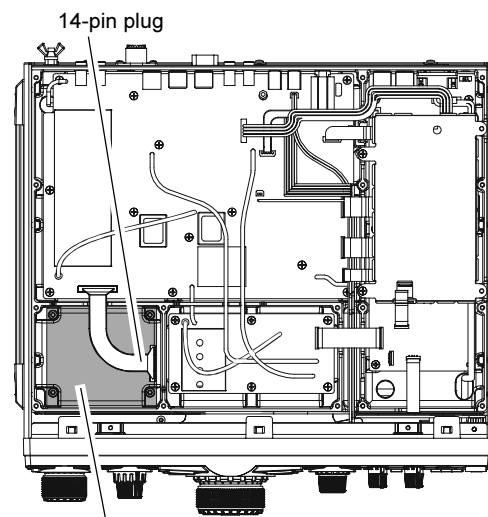

FIGURE 1



SCOPE Unit Mounting Location

FIGURE 2

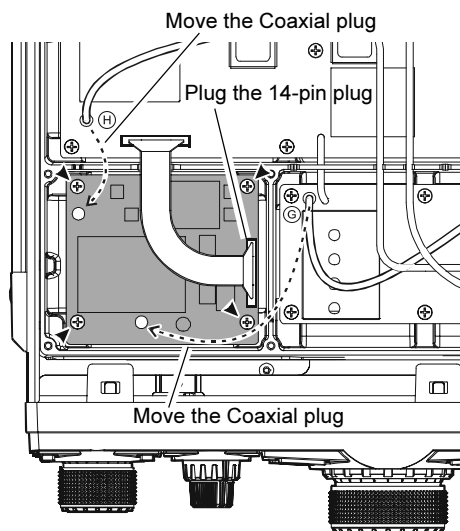

FIGURE 3

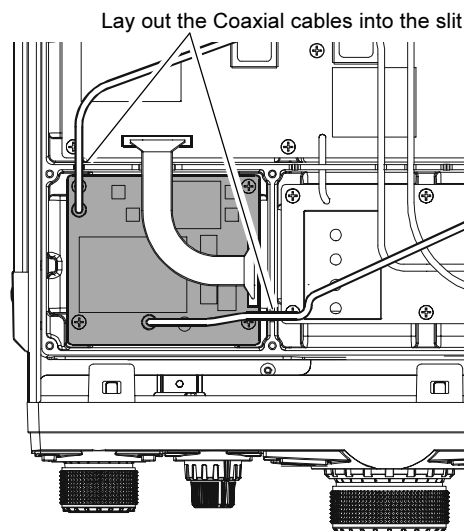

FIGURE 4

INSTALLATION OF OPTIONAL ACCESSORIES

DATA MANAGEMENT UNIT (DMU-2000)

Interconnections to FT-950

Connect the **DMU-2000** and **FT-950** transceiver, your after market Display, and your after market Keyboard (if used) as shown in Figure below.

NOTICE:

Keep an inch (2.5 cm) of space on either side of the **DMU-2000** to prevent overheating.

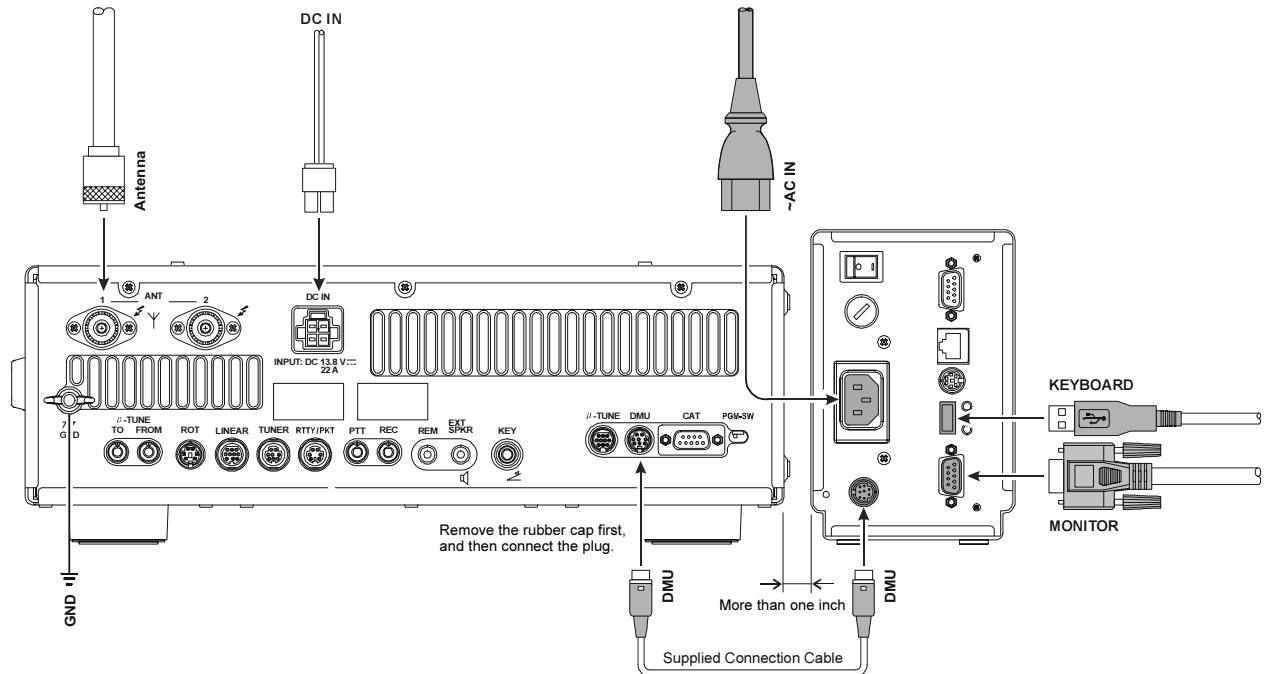

Operation

The operation of the **DMU-2000** is described in the Operation Manual supplied with the **DMU-2000**.

However, the arrangement of the function keys is different than the **FT-2000**. The **FT-950** **[BAND]** buttons are used for the **DMU-2000** operations instead of Function Buttons. Press and hold the **FT-950** **[ENT(DISPLAY)]** button for one second, the **FT-950**'s **[BAND]** buttons will act as "function" keys for the **DMU-2000**. Please see the **DMU-2000** Operation Manual for operating details.

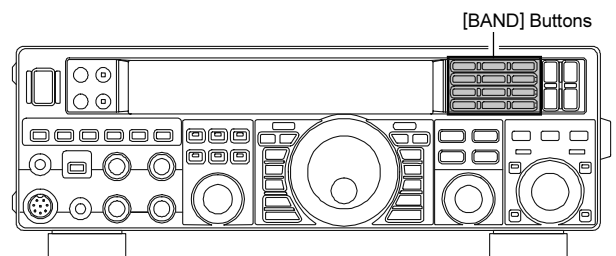

SPECIFICATIONS

General

| | |
|-------------------------------------|---|
| Rx Frequency Range: | 30 kHz - 56 MHz (operating) 1.8 MHz - 50 MHz (specified performance, Amateur bands only) |
| Tx Frequency Ranges: | 1.8 MHz - 50 MHz (Amateur bands only) |
| Frequency Stability: | ±0.5 ppm (after 1 minute @+77 °F [+25 °C]) ±1.0 ppm (after 1 minute @+14 °F to +122 °F [-10 °C to +50 °C]) |
| Operating Temperature Range: | +14 °F to +122 °F (-10 °C to +50 °C) |
| Emission Modes: | A1A (CW), A3E (AM), J3E (LSB, USB), F3E (FM), F1B (RTTY), F1D (PACKET), F2D (PACKET) |
| Frequency Steps: | 1/10 Hz (SSB, CW, & AM), 100 Hz (FM) |
| Antenna Impedance: | 50 Ohms, unbalanced 16.7 - 150 Ohms, unbalanced (Tuner ON, 1.8 MHz - 50 MHz Amateur bands, TX only) |
| Power Consumption (Approx.): | Rx (no signal) 1.8 A Rx (signal present) 2.1 A Tx (100 W) 22 A |
| Supply Voltage: | DC 13.8 V ± 10% (Negative Ground) |
| Dimensions (WxHxD): | 14.4" x 4.5" x 12.4" (365 x 115 x 315 mm) |
| Weight (Approx.): | 21.6 lbs (9.8 kg) |

Transmitter

| | |
|--|---|
| Power Output: | 5 - 100 watts (2 - 25 watts AM carrier) |
| Modulation Types: | J3E (SSB): Balanced, A3E (AM): Low-Level (Early Stage), F3E (FM): Variable Reactance |
| Maximum FM Deviation: | ±5.0 kHz/±2.5 kHz |
| Harmonic Radiation: | Better than -60 dB (1.8 MHz - 28 MHz Amateur bands: Harmonics) Better than -50 dB (1.8 MHz - 28 MHz Amateur bands: Others) Better than -65 dB (50 MHz Amateur band) |
| SSB Carrier Suppression: | At least 60 dB below peak output |
| Undesired Sideband Suppression: | At least 60 dB below peak output |
| 3rd-order IMD: | -31 dB @14 MHz 100 watts PEP |
| Bandwidth: | 3 kHz (LSB/USB), 500 Hz (CW), 6 kHz (AM), 16 kHz (FM) |
| Audio Response (SSB): | Not more than -6 dB from 300 to 2700 Hz |
| Microphone Impedance: | 600 Ohms (200 to 10 kOhms) |

Receiver

| | | |
|-------------------------------------|--|--|
| Circuit Type: | Triple-conversion Superheterodyne | |
| Intermediate Frequencies: | 69.450 MHz/450 kHz/30 kHz (24 kHz for AM/FM) | |
| Sensitivity: | SSB (BW: 2.4 kHz, 10 dB S+N/N) 4 μ V (0.5 - 1.8 MHz) (IPO "ON") 0.2 μ V (1.8 - 30 MHz) (RF AMP 2 "ON") 0.125 μ V (50 - 54 MHz) (RF AMP 2 "ON") AM (BW: 6 kHz, 10 dB S+N/N, 30 % modulation @400 Hz) 28 μ V (0.5 - 1.8 MHz) (IPO "ON") 2 μ V (1.8 - 30 MHz) (RF AMP 2 "ON") 1 μ V (50 - 54 MHz) (RF AMP 2 "ON") FM (BW: 15 kHz, 12 dB SINAD) 0.5 μ V (28 - 30 MHz) (RF AMP 2 "ON") 0.35 μ V (50 - 54 MHz) (RF AMP 2 "ON") | |
| | There is no specification for frequency ranges not listed. | |
| Selectivity (WIDTH: Center): | Mode | -6 dB -60 dB |
| | CW/RTTY/PKT | 0.5 kHz or better 750 Hz or less |
| | SSB | 2.4 kHz or better 3.6 kHz or less |
| | AM | 6 kHz or better 15 kHz or less |
| | FM | 15 kHz or better 25 kHz or less |
| Image Rejection: | 70 dB or better (1.8 MHz - 28 MHz Amateur bands) 60 dB or better (50 MHz Amateur band) | |
| Maximum Audio Output: | 2.5 W into 4 Ohms with 10% THD | |
| Audio Output Impedance: | 4 to 8 Ohms (4 Ohms: nominal) | |
| Conducted Radiation: | Less than 4 nW | |

Specifications are subject to change, in the interest of technical improvement, without notice or obligation, and are guaranteed only within the amateur bands.

This equipment has been tested and found to comply with the limits for a Class B digital device, pursuant to Part 15 of the FCC Rules. These limits are designed to provide reasonable protection against harmful interference in a residential installation. This equipment generates, uses and can radiate radio frequency energy and, if not installed and used in accordance with the instructions, may cause harmful interference to radio communications. However, there is no guarantee that interference will not occur in a particular installation.

If this equipment does cause harmful interference to radio or television reception, which can be determined by turning the equipment off and on, the user is encouraged to try to correct the interference by one or more of the following measures:

- Increase the separation between the equipment and receiver.
- Connect the equipment into an outlet on a circuit different from that to which the receiver is connected.
- Consult the dealer or an experienced radio/TV technician for help.

1. Changes or modifications to this device not expressly approved by YAESU could void the user's authorization to operate this device.
2. This device complies with part 15 of the FCC Rules. Operation is subject to the following two conditions; (1) this device may not cause harmful interference, and (2) this device must accept any interference including interference that may cause undesired operation.
3. The scanning receiver in this equipment is incapable of tuning, or readily being altered, by the User to operate within the frequency bands allocated to the Domestic public Cellular Telecommunications Service in Part 22.

DECLARATION BY MANUFACTURER

The scanner receiver is not a digital scanner and is incapable of being converted or modified a digital scanner receiver by any user.

WARNING: MODIFICATION OF THIS DEVICE TO RECEIVE CELLULAR RADIOTELEPHONE SERVICE SIGNALS IS PROHIBITED UNDER FCC RULES AND FEDERAL LAW.

YAESU



Declaration of Conformity

We, YAESU UK LTD. declare under our sole responsibility that the following equipment complies with the essential requirements of the Directive 1999/5/EC and 2011/65/EU.

Type of Equipment: HF Transceiver
Brand Name: YAESU
Model Number: FT-950
Manufacturer: YAESU MUSEN CO., LTD.
Address of Manufacturer: Tennozu Parkside Building, 2-5-8 Higashi-Shinagawa,
Shinagawa-ku, Tokyo 140-0002 Japan

Applicable Standards:

This equipment is tested and conforms to the essential requirements of directive, as included in following standards.

Radio Standard: EN 301 783-2 V1.2.1
EMC Standard: EN 301 489-1 V1.9.2
EN 301 489-15 V1.2.1
Safety Standard: EN 60065:2002 +A1:2006 +A11:2008+A2:2010 +A12:2011
RoHS2 Standard: EN 50581 : 2012

The technical documentation as required by the Conformity Assessment procedures is kept at the following address:

Company: YAESU UK LTD.
Address: Unit 12, Sun Valley Business Park, Winnall Close
Winchester, Hampshire, SO23 0LB, U.K.

Disposal of your Electronic and Electric Equipment

Products with the symbol (crossed-out wheeled bin) cannot be disposed as household waste. Electronic and Electric Equipment should be recycled at a facility capable of handling these items and their waste byproducts.

In EU countries, please contact your local equipment supplier representative or service center for information about the waste collection system in your country.



Attention in case of use

This transceiver works on frequencies which are not generally permitted. As for the actual usage, the user has to possess an amateur radio licence. Usage is allowed only in the frequency bands which are allocated for amateur radios.

| List of the practicable area | | | | | | |
|------------------------------|-----|-----|-----|-----|-----|-----|
| AUT | BEL | BGR | CYP | CZE | DEU | DNK |
| ESP | EST | FIN | FRA | GBR | GRC | HUN |
| IRL | ITA | LTU | LUX | LVA | MLT | NLD |
| POL | PRT | ROM | SVK | SVN | SWE | CHE |
| ISL | LIE | NOR | | | | |

YAESU

The radio

Copyright 2013
YAESU MUSEN CO., LTD.
All rights reserved

No portion of this manual
may be reproduced without
the permission of
YAESU MUSEN CO., LTD.

Printed in Japan

1305O-EY



E H 0 3 1 H 2 0 6