

System Fusion

DR-1X / DR-1XE

Operating Manual

144/430MHz 50W
VHF/UHF AMS DIGITAL REPEATER

C4FM FDMA/FM

Before Using

Installation and Connection

Operations

Appendix



Features of this radio

- 144/430 MHz repeater is equipped with a standard C4FM digital communication modem capable of selecting the communications mode automatically
- Clear audio and data communication is achieved using the digital modem functions
- Transmit power 50 watts with cooling fan
- Full color 3.5-inch LCD, high luminance TFT touch panel controller
- Intuitive, user touch panel operation

About the touch panel

● Precautions in using the touch panel

The touch panel of the controller is designed to work with the slightest touch of a finger.

- The touch panel may not work when a protective film or sheet is affixed to the LCD.
- Use of a pointed fingernail or pen to operate the touch panel, or pressing too hard may damage or scratch the screen.
- Smart phone operations such as flicking, pinch in and pinch out are not possible.

● Maintaining the touch panel

- To clean the touch panel, switch the power supply OFF before using a dry, soft cloth to wipe away dust and dirt from the touch panel. When the touch panel is really dirty, wet a soft cloth and wring it out thoroughly before using it to wipe the touch panel.
- When wiping the touch panel, be careful not to wipe too hard or scratch the surface with your nails. When the touch panel is scratched, it may become difficult to see the display.

About registered trademarks and copyrights

Company and product names described in this manual are trademarks and registered trademarks of their respective companies.

Unauthorized reproduction or copying of a part or all of the copyrights owned by Yaesu Musen Co., Ltd. in any form whatsoever is strictly prohibited.

How to read this manual

In this manual, controller operations are expressed as follows:

Touch **[SQL]**Indicates that the symbol on the touch panel screen is to be touched quickly.

Select **[MODE]**Indicates that the items are to be highlighted on the touch panel screen.

The following symbols are also used in this manual:

Caution  ...Explains information to avoid incorrect operation.

Tip  ...Explains operating hints and helpful advice.

Also note: the actual product may differ from the drawings shown in this manual.

Contents

Introduction.....	2	Setting other configuration.....	36
Features of this radio.....	2	Setting the repeater for remote operation.....	36
About the touch panel.....	2	Turning transmission ON/OFF from the remote controller.....	36
About registered trademarks and copyrights.....	2	Setting the display turn-on time.....	37
How to read this manual.....	2	Setting the Packet Speed.....	37
Before Using.....	4	Restoring Default Settings (Factory Reset).....	38
Safety Precautions (make sure to read these).....	4	Appendix.....	39
Accessories.....	6	Installation of the Optional Voice Guide Unit "FVS-2".....	39
Options.....	6	Maintenance.....	40
Name and Function of Each Component.....	7	Care and maintenance.....	40
Front.....	7	Replacing the fuse.....	40
Rear.....	8	Advice When There Is a Problem.....	41
Explanation of the screen.....	9	There is no power.....	41
Installation and Connection.....	11	There is no sound.....	41
Setting up the Repeater.....	11	There is no transmission.....	41
Safety measures for installation.....	11	There is no screen on the display.....	41
Installing the repeater.....	11	About internal spurious signals.....	41
Mounting on a desk.....	11	After-market Services.....	41
About electrical grounding.....	12	Specifications.....	42
About the antenna.....	12		
Antenna consideration.....	12		
Connecting the antenna.....	13		
Connecting the Power Supply.....	14		
Connection for DR-1X.....	14		
Connection for DR-1XE.....	15		
Connecting External Devices.....	16		
Connection of an external microphone or PTT switch.....	16		
Connection to a personal computer.....	16		
Connection to an external controller.....	17		
To use DR-1X/DR-1XE in Remote mode.....	18		
Repeater Operation.....	19		
Basic Operations.....	19		
Turning the power on.....	19		
Switching the power off.....	19		
Setting the ID (call sign).....	19		
Turning the display on and off.....	20		
Adjusting the volume.....	20		
Switching the operating mode.....	21		
Switching the communication mode.....	22		
Adjusting the squelch level.....	22		
Adjusting the transmit power.....	23		
Setting the TX Inhibit.....	24		
Remote Operation.....	25		
Turning remote operation ON/OFF.....	25		
Control from external controller.....	26		
Base Station Operation.....	27		
Transmitting C4FM digital signals.....	27		
Setting up the Repeater.....	28		
Setup menu basic operations.....	28		
Setting the frequency.....	29		
Setting the tone signals.....	30		
Setting the tone frequency.....	30		
Setting the DCS code.....	30		
Switching the tone signal types.....	31		
Setting the digital squelch code.....	32		
Setting the ID (call sign).....	32		
Setting the ID announcement.....	33		
Setting the way to announce.....	33		
Setting the announcement output level.....	34		
Setting the ID announcement CW speed.....	34		
Setting the announcement time interval.....	35		
Setting the TOT (timeout timer).....	36		

Safety Precautions (make sure to read these)

Make sure to read this manual in order to use this radio safely and correctly.

Note beforehand that the company shall not be liable for any damages suffered by the customer or third parties in using this product, or for any failures and faults that occur during the use or misuse of this product, unless otherwise provided for under the law.



Type and meaning of the marks



 **DANGER** This symbol indicates the possibility of death or serious injury being inflicted on the user and the surrounding people when these instructions are ignored and the product is handled improperly.

 **WARNING** This symbol indicates the possibility of death or serious injury being inflicted on the user and the surrounding people when these instructions are ignored and the product is handled improperly.

 **CAUTION** This symbol indicates the possibility of physical impediments occurring or impediments being inflicted on the user and the surrounding people when these instructions are ignored and the product is handled improperly.

Type and meaning of symbols

 Prohibited actions that must not be carried out in order to use this radio safely. For example,  signifies that disassembly is prohibited.

 Precautions that must be adhered to in order to use this radio safely. For example,  signifies that the power supply is to be disconnected.

DANGER

 **Do not use the device in "locations or aircraft and vehicles where its use is prohibited" such as in hospitals and aeroplanes.**
This may exert an impact on electronic and medical devices.

 **Never touch the antenna during transmission.**
This may result in injury, electric shock and equipment failure.

 **Do not transmit in crowded places in consideration of people who are fitted with medical devices such as heart pacemakers.**
Electromagnetic waves from the device may affect the medical device, resulting in accidents caused by malfunctions.

 **Do not operate the device when flammable gas is generated.**
Doing so may result in fire and explosion.

 **Use good engineering, proper grounding and protective devices to protect the repeater from power surges, lightning and electrical damage via the power and external antenna connections.**

 **Otherwise when it thunders, immediately disconnect the external antenna from the repeater and shut OFF the power supply.**
If not, fire, electric shock and equipment failure this may result.

 **Do not touch any liquid leaking from the liquid display with your bare hands.**

 There is a risk of chemical burns occurring when the liquid comes into contact with the skin or gets into the eyes. In this case, seek medical treatment immediately.

WARNING

 **Do not use voltages other than the specified power supply voltage.**
Doing so may result in fire and electric shock.

 **Do not transmit continuously for long periods of time.**
This may cause the temperature of the main body to rise and result in burns and failures due to overheating.

 **Do not dismantle or modify the device.**
This may result in injury, electric shock and equipment failure.

 **Do not handle the power plug and connector etc. with wet hands. Also do not plug and unplug the power plug with wet hands.**
This may result in injury, electric shock and equipment failure.

When smoke or strange odors are emitted from the radio, turn off the power and disconnect the power cord from the socket.

 This may result in fire, liquid leak, overheating, damage, ignition and equipment failure. Please contact our company amateur customer support or the retail store where you purchased the device.

 **Keep the power plug pins and the surrounding areas clean at all times.**
This may result in fire, overheating, breakage, ignition etc.

 **Do not place the device in areas that may get wet easily (e.g. near a humidifier).**
This may result in fire, electric shock and equipment failure.



 **When connecting a DC power cord, pay due care not to mix up the positive and negative polarities.**
This may result in fire, electric shock and equipment failure.



 **Do not use power cords other than the one enclosed or specified.**
This may result in fire, electric shock and equipment failure.

 **Do not bend, twist, pull, heat and modify the power cord and connection cables in an unreasonable manner.**
This may cut or damage the cables and result in fire, electric shock and equipment failure.









 **Do not pull the cable when plugging and unplugging the power cord and connection cables.**
Please hold the plug or connector when unplugging. If not, this may result in fire, electric shock and equipment failure.









 **Do not use the device when the power cord and connection cables are damaged, and when the power connector cannot be plugged in tightly.**
Please contact our company amateur customer support or the retail store where you purchased the device as this may result in fire, electric shock and equipment failure.

-  **Do not use fuses other than those specified.**
Doing so may result in fire and equipment failure.
-  **Do not allow metallic objects such as wires and water to get inside the product.**
This may result in fire, electric shock and equipment failure.
-  **Disconnect the power cord and connection cables before incorporating items sold separately or replacing the fuse.**
This may result in fire, electric shock and equipment failure.

-  **Follow the instructions given when installing items sold separately and replacing the fuse.**
This may result in fire, electric shock and equipment failure.
-  **Do not use the device when it thunders.**
For safety reasons, pull the power plug out of the AC socket. Never touch the antenna as well. This may result in fire, electric shock and equipment failure due to thunder.

CAUTION

-  **Do not place this device near a heating instrument or in a location exposed to direct sunlight.**
This may result in deformation and discoloration.
-  **Do not place this device in a location where there is a lot of dust and humidity.**
Doing so may result in fire and equipment failure.
-  **Stay as far away from the antenna as possible during transmission.**
Long-term exposure to electromagnetic radiation may have a negative effect on the human body.
-  **Do not wipe the case using thinner and benzene etc.**
Please use a soft and dry piece of cloth to wipe away the stains on the case.
-  **Do not put heavy objects on top of the power cord and connection cables.**
This may damage the power cord and connection cables, resulting in fire and electric shock.
-  **Do not transmit near the television and radio.**
This may result in electromagnetic interference.
-  **Do not use optional products other than those specified.**
If not, this may result in equipment failure.
-  **Do not place the device on an unsteady or sloping surface, or in a location where there is a lot of vibration.**
The device may fall over or drop, resulting in fire, injury and equipment failure.

-  **For safety reasons, switch off the power and pull out the power cord when the device is not going to be used for a long period of time.**
If not, this may result in fire and overheating.
-  **Do not throw or subject the device to strong impact forces.**
This may result in equipment failure.
-  **Do not put this device near magnetic cards and video tapes.**
The data in the cash card and video tape etc. may be erased.
-  **Keep out of the reach of small children.**
If not, this may result in injuries to children.
-  **Do not stand on top of the product, and do not place heavy objects on top or insert objects inside it.**
If not, this may result in equipment failure.
-  **Do not use a microphone other than those specified when connecting a microphone to the device.**
If not, this may result in equipment failure.
-  **Do not touch the heat radiating parts.**
When used for a long period of time, the temperature of the heat radiating parts will get higher, resulting in burns when touched.
-  **Do not open the case of the product except when replacing the fuse and when installing items sold separately.**
This may result in injury, electric shock and equipment failure.

Accessories

AC Power Cord (T9017882) *1	1
DC Power Cord with Fuse (T9026115)	1
Spare Fuse 15 A (Q0000075)	1
5 A (Q0000143) *1	1
Case Legs (S4000052)	4
PC Connection Cable SCU-20 (T9101621)	1
Operating Manual (this manual)	1
Warranty Certificate	1

*1: For DR-1X only

Options

DTMF Microphone MH-48A6JA
Hand Microphone MH-42C6J
Voice Guide Unit FVS-2

Name and Function of Each Component

Front

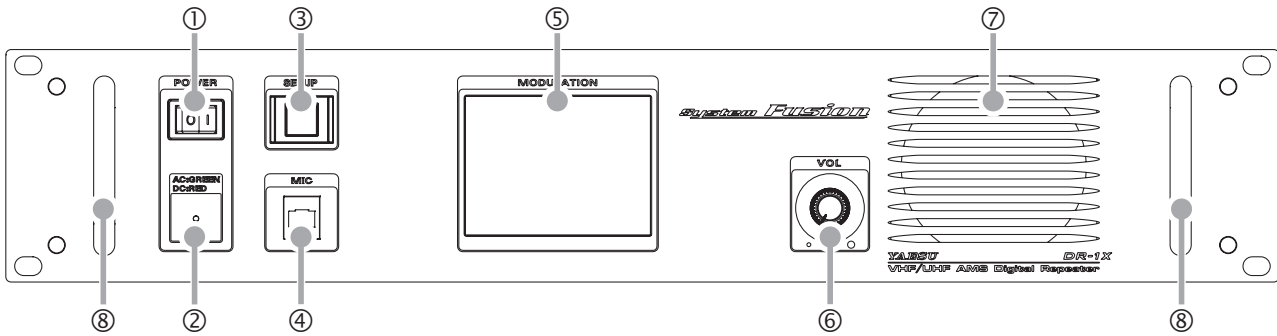

- ① POWER switch
Press "I" side to switch the radio on, and "O" side to switch the radio off.
- ② Power supply monitor (LED indicator)
 - When the indicator illuminates in green, the power is supplied from the AC IN jack (DR-1X only).
 - When the indicator illuminates in red, the power supply is backed up through the BACKUP terminals (13.8 V DC).
- ③ SETUP button
Press to switch the display on and off.
- ④ MIC jack
Insert the plug of the optional microphone to this 6-pin modular jack.
- ⑤ Touch panel display
- ⑥ VOL knob
The audio volume of the received (up link) signal will increase when the knob is turned in a clockwise direction and decrease when turned in a counter-clockwise direction.
- ⑦ Speaker
The internal speaker is located here.
- ⑧ Handle

Rear

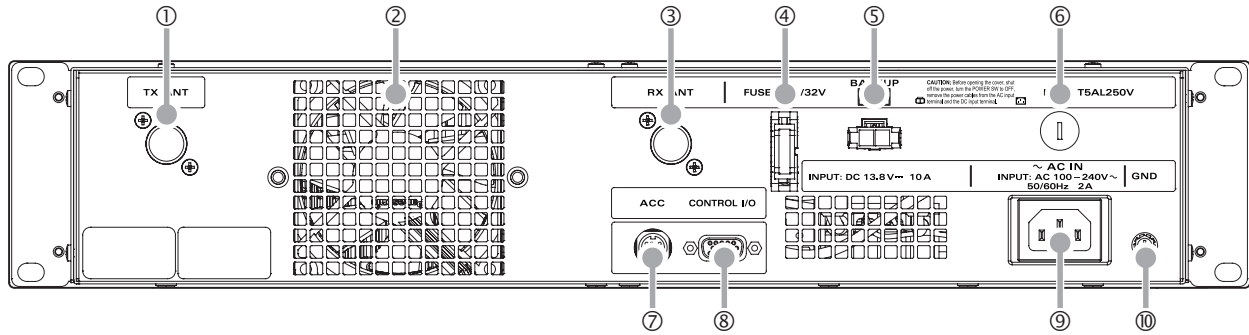

Note The figure above shows the rear panel of the DR-1X.

- ① TX ANT terminal
Connect to the transmitting antenna (down link) with the coaxial cable.
The output impedance requirement is 50 ohms.
- ② Air outlet for cooling fan
- ③ RX ANT terminal
Connect to the receiving antenna (up link) with the coaxial cable.
The input impedance requirement is 50 ohms.
- ④ FUSE 15A jack
A 15 A fuse for the DC power supply through the BACKUP terminals is attached.
- ⑤ BACKUP terminals
Connect to the 13.8 V DC power supply.
- ⑥ FUSE 5A jack (DR-1X only)
A 5 A fuse for the AC power supply through the AC IN jack is attached.
- ⑦ ACC jack
Connect to a personal computer with the provided PC connection cable “SCU-20”.
- ⑧ CONTROL I/O connector
This connector allows the repeater to be connected to an external controller for remote operation.
- ⑨ AC IN jack (DR-1X only)
Connect to the 100 V to 240 V AC power supply with the provided power cable.
- ⑩ GND terminal

Explanation of the screen

Operation mode screen

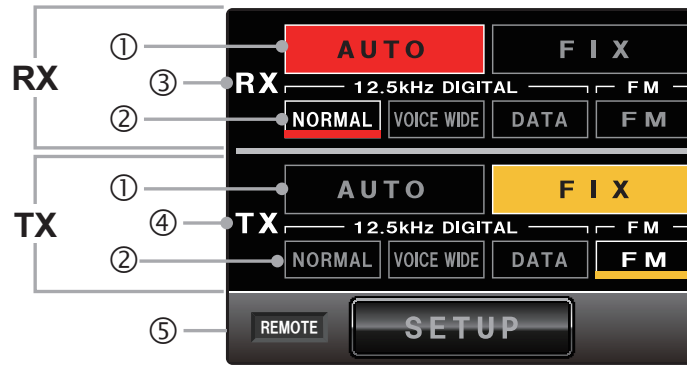

RX Receive (up link) band display area

TX Transmit (down link) band display area

① Operation mode display area

[AUTO] Touch here to activate the AMS (automatic mode select) function. The communication mode switches automatically according to the received/transmitted signal types.

[FIX] Touch here to receive/transmit signals in the selected communication mode at all time.

② Communication mode display area

The items are displayed in red during the AUTO mode and yellow during the FIX mode.

[NORMAL] Indicates operation is in the simultaneous voice and data communication mode (digital).

[VOICE WIDE] Indicates operation is in the high-rate voice communication mode (digital).

[DATA] Indicates operation is in the high speed data communication mode (digital).

[FM] Indicates operation is in the analog communication mode on the FM band.

③ RX indicator

This indicator shows green when a signal is received and white when there is no signal.

④ TX indicator

This indicator shows red when the repeater transmits and white when there is no transmit.

⑤ Settings display area

[REMOTE] Displayed in red when remote operation with an external controller is enabled (see page 24).

[SETUP] Touch here to switch the display to the setup mode screen.

Setup mode screen

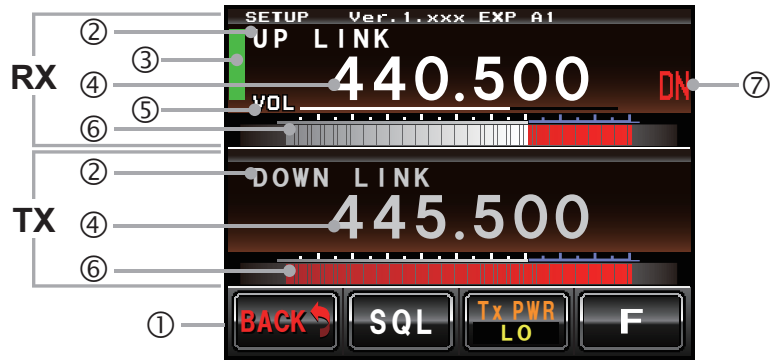

RX Receive (up link) band display area
TX Transmit (down link) band display area

- ① Touch key display area
 - [BACK]** Touch here to return to the operation mode screen.
 - [SQL]** Touch here to set the squelch level of the receiver.
 - [Tx PWR]** Touch here to set the transmitter output level.
 - [F]** Touch here to display the setup menu.
- ② Direction display area
 - “UP LINK” is displayed on the RX band.
 - “DOWN LINK” is displayed on the TX band.
- ③ Status display area
 - A green bar is displayed during receive when signals are detected.
 - The bar will not be displayed when the squelch is turned on.
- ④ Frequency display
- ⑤ VOL/SQL level display
- ⑥ S-meter/transmission power level display
- ⑦ Communication mode display

● Squelch level setting screen

The screen appears as below after **[SQL]** is touched.

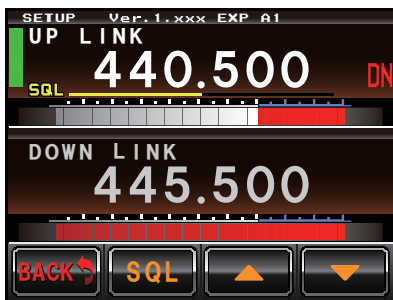

[▲][▼]

The squelch threshold will increase by touching **[▲]** and decrease by touching **[▼]**.

Setting up the Repeater

Safety measures for installation

Note the followings precautions when installing this repeater.

- Use good engineering, proper grounding and protective devices to protect the repeater from power surges, lightning and electrical damage via the power and external antenna connections.
- Do not install the repeater in a place where there is extreme vibration, where there is a lot of dust, excessive humidity or high temperature, or where it is exposed to direct sunlight.
- Install the repeater in a well ventilated position, so heat dissipation is not obstructed. The heat sink becomes hot when transmitting for long periods of time.
- Do not place any objects on top of the repeater.
- Note that there is a risk that hum and noise may be introduced, depending on the installation conditions and the external power source used.
- Install the repeater as far as possible away from TV and radio equipment to avoid (TVI, BCI).
In particular, do not install the repeater near indoor antenna elements.

Installing the repeater

Place the repeater on a flat and level rack or shelf, with its bottom side down.

We recommend securing the wings of the repeater front panel to the equipment rack or shelf with bolts.

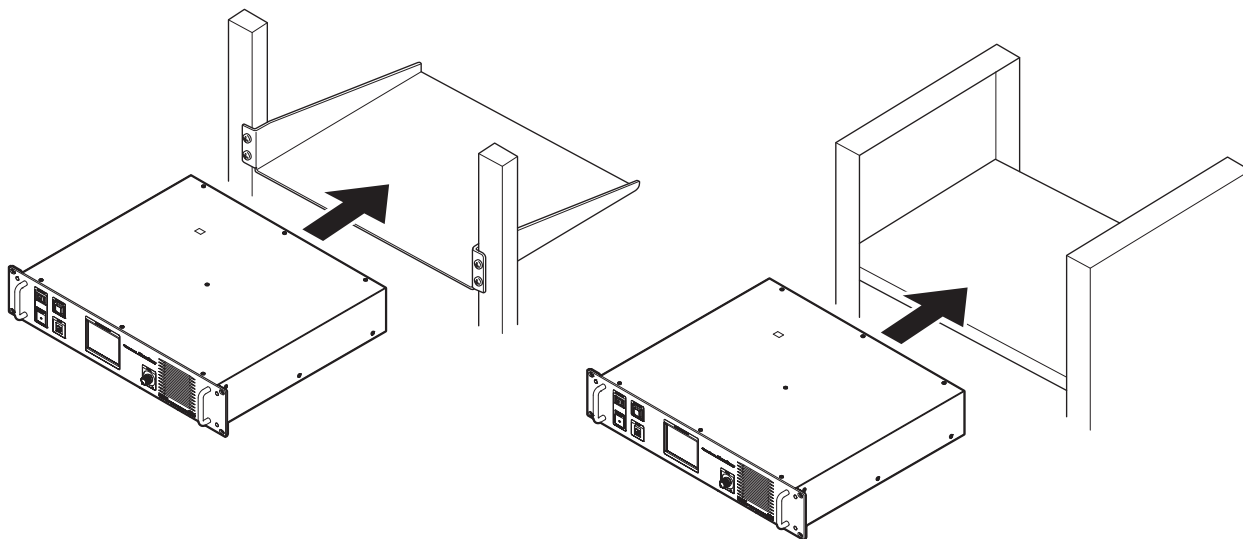

Mounting on a desk

When using the repeater in a desktop location instead of a rack or shelf, attach the four supplied legs onto the bottom of the repeater case.

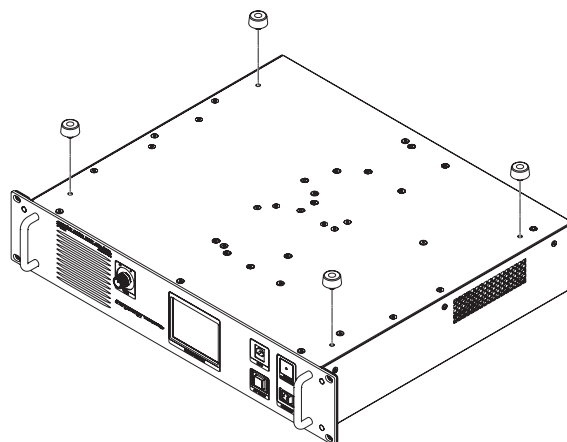

About electrical grounding

The DR-1X/DR-1XE repeater, like any other communications apparatus, requires an effective ground system for maximum electrical safety and best communications effectiveness. A good ground system can contribute to station efficiency in a number of ways:

- It can minimize the possibility of electrical shock to the operator.
- It can minimize RF currents flowing on the shield of the coaxial cable and the chassis of the repeater. Such currents may lead to radiation, which can cause interference to home entertainment devices or laboratory test equipment.
- It can minimize the possibility of erratic repeater/accessory operation caused by RF feedback and/or improper current flow through logic devices.

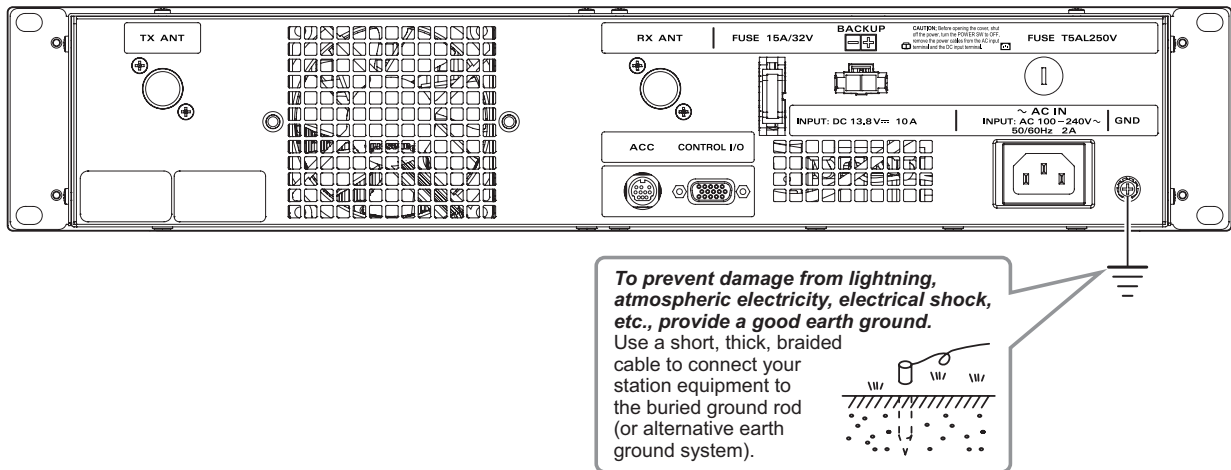

Note The figure above shows the rear panel of the DR-1X.

About the antenna

A good antenna installation is extremely important for transmission and reception purposes. Note the followings, as the type and characteristics of the antenna largely determines whether the performance of the repeater can be fully realized.

- Use an antenna that is designed for the installation conditions and application objective.
- Use an antenna that is tuned for the operating band and frequency.
- Use an antenna and a co-axial cable with a characteristic impedance of 50Ω.
- Adjust the VSWR (standing wave ratio) until it is 1.5 or less for an antenna with an adjusted impedance of 50Ω.
- Keep the coaxial cable routing length as short as possible.
- Use lightning and voltage surge protection devices.

Antenna consideration

Repeater operation without a duplexer requires that two antennas be installed, one for receiving and one for transmitting, so that the receiving antenna does not absorb energy from the transmitting antenna. There are a number of ways to do this, depending on the TX/RX frequency separation, and on the locations available for antenna mounting. If a duplexer is used, a single antenna suffices for both transmitting and receiving. If using a reduced-size duplexer, a six-cavity model (minimum) is recommended. Yaesu recommends the use of the duplexer. For further details, contact your Yaesu dealer.

Regardless of the above choice, it is of paramount importance that the antenna(s) be mounted as high and in the clear as possible, preferably within line-of-sight to all repeater users. Furthermore, losses in the feedline(s) must be minimized, so the feedline(s) should be high quality, and as short as possible. If a long feedline is necessary, use coaxial “hardline” cable to reduce losses. Repeater antennas should have an impedance of 50 Ω at the operating frequency. When separate receive and transmit antennas are used, high-Q narrow-band types may serve to minimize interaction. However, when a single antenna is used with a duplexer, it should be a low-Q wide-band type.

Cautions

- Never transmit without having a transmit antenna connected to the TX antenna jack of the Repeater.
- Create a loop (slack) in the coaxial cable directly underneath the antenna and fasten it so that the weight of the cable does not pull on the antenna or connector itself.
- Install the antenna taking into consideration the securing supports and how the guying wires are positioned, so that the antenna does not fall over or get blown away in strong winds.

Connecting the antenna

- 1 Plug the coaxial connectors into the TX ANT and RX ANT jacks respectively at the rear of the repeater, and tighten the shields onto the jacks.

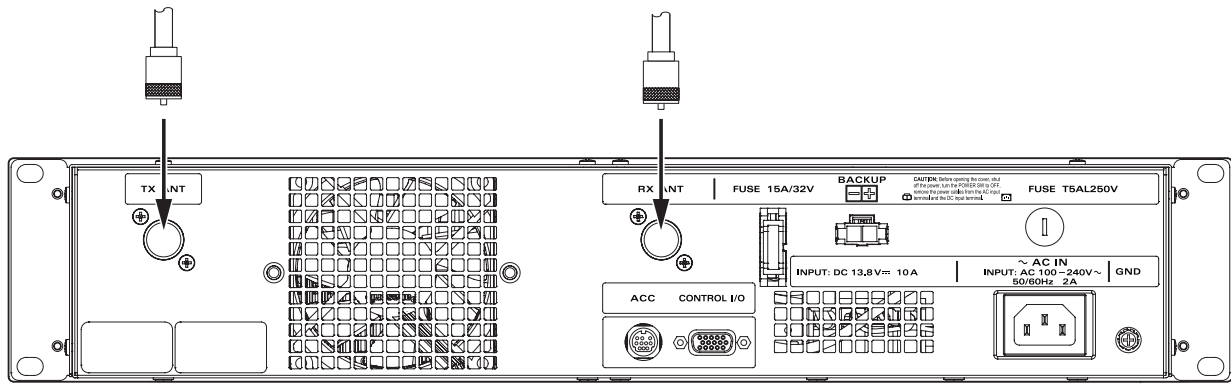

Note The figure above shows the rear panel of the DR-1X.

- 2 To use a duplexer prepared by yourself, plug in the terminal of the coaxial cables from the TX ANT and RX ANT terminals into the jacks of the duplexer, and turn to tighten
- 3 Plug in the terminal of the coaxial cable connected to the antenna into the jack of the duplexer, and turn to tighten

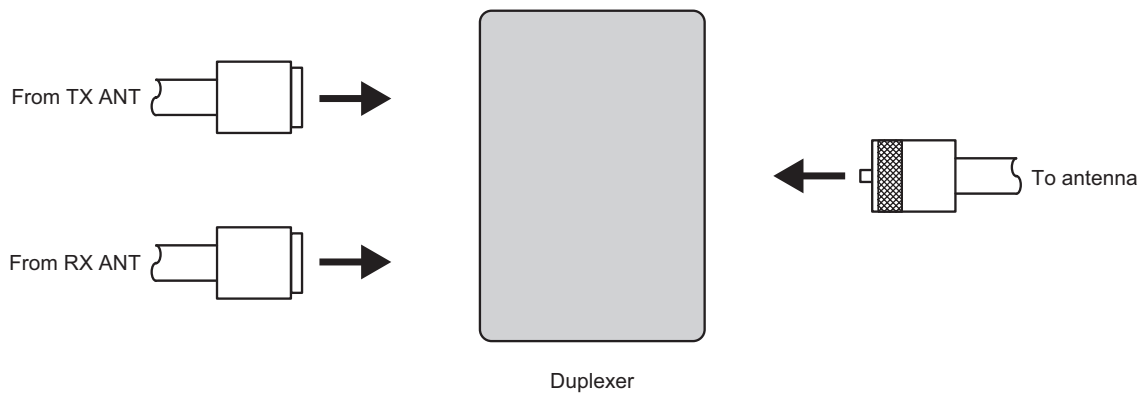

Connecting the Power Supply

Connection for DR-1X

● Main power

Caution

- Use an AC outlet capable of supplying AC 100 to 240 V at 50 or 60 Hz.

- 1 Insert the socket of the provided AC power cord into the AC IN jack at the rear of the repeater
- 2 Insert the plug of the provided AC power cord into the AC outlet

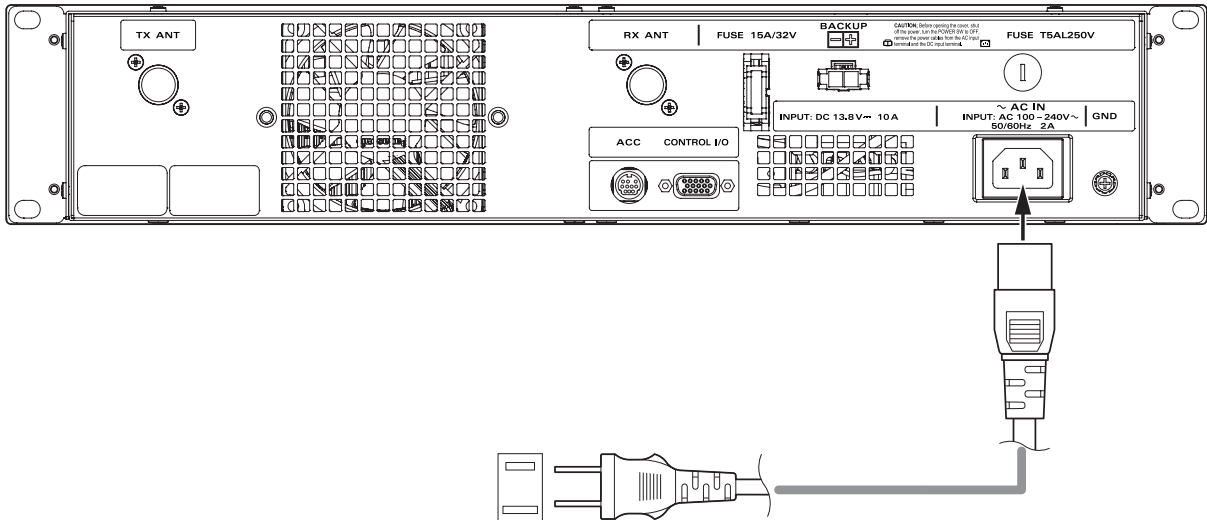

● Backup power

For uninterrupted operation during power failures, a 13.8 V rechargeable automotive type battery (55-Ah or more recommended) may be connected to the BACKUP terminal posts on the rear panel. In the event of an AC power outage, the automatic power control circuit will automatically switch the repeater to the backup battery, and operation will not be interrupted.

If the power is out for a long time, the battery may be completely discharged. When the power is restored the DC startup current may blow the protection fuse. So the protection fuse in charge circuit should be checked after an outage.

While operating from a battery or DC supply, the repeater requires approximately 14 A at 13.8 V during transmit.

Follow the outline in the illustration regarding the proper connection of the DC power cable.

Always observe proper polarity when making DC connection.

Cautions

- Use a power source capable of supplying DC 13.8 V and a current capacity of 14 A or more.
- Make sure to switch OFF the power of the external power source before connecting.

- 1 Insert the socket of the provided DC power cord to the BACKUP jack at the rear of the repeater
- 2 Connect the **red** wire (+) of the provided DC power cord to the positive (+) terminal of the external power source, and the **black** wire (-) to the negative (-) terminal

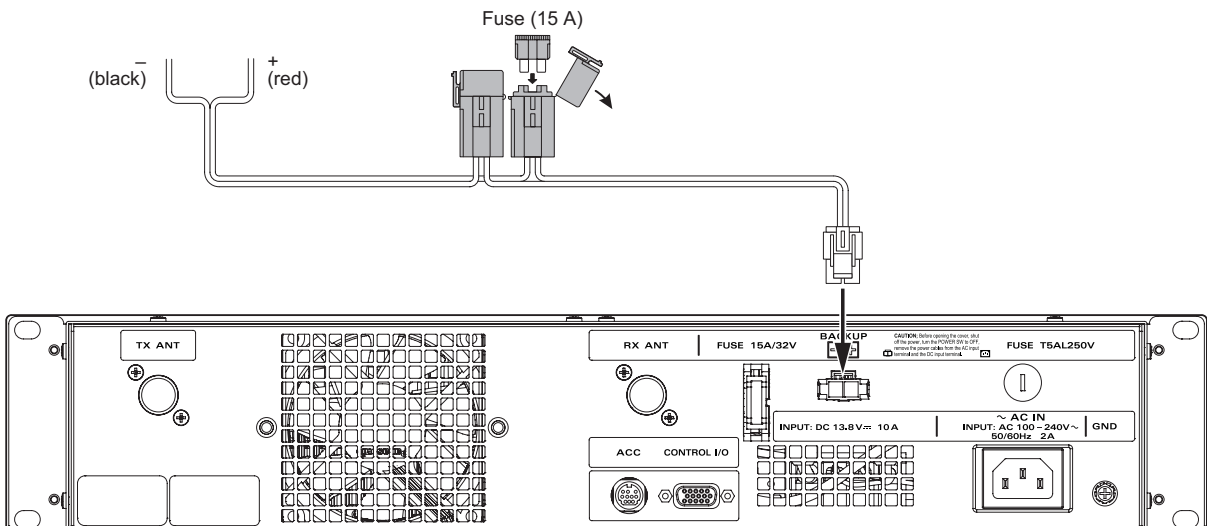

Connection for DR-1XE

Follow the outline in the illustration regarding the proper connection of the DC power cable.

The DC power connector for the DR-1XE must only be connected to a DC source providing 13.8 V DC ($\pm 15\%$), and capable of at least 10 A of current.

Always observe proper polarity when making DC connection.

Caution

- Make sure to switch OFF the power of the external power source before connecting.

- 1 Insert the socket of the provided DC power cord to the DC IN jack at the rear of the repeater
- 2 Connect the **red** wire (+) of the provided DC power cord to the positive (+) terminal of the external power source, and the **black** wire (-) to the negative (-) terminal

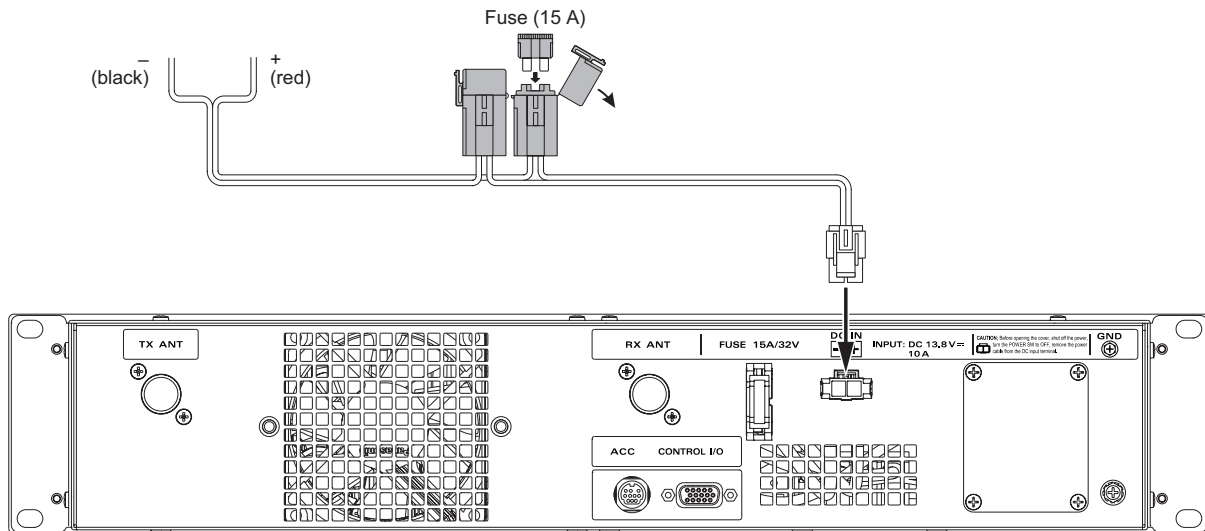

Tip

The external power source should be installed near the equipment and should be easily accessible.



Permanent damage can result when improper supply voltage, or reverse-polarity voltage, is applied to the DR-1XE. The Limited Warranty on this radio does not cover damage caused by application of AC voltage, reverse polarity DC, or DC voltage outside the specified range of 13.8 V $\pm 15\%$. When replacing fuses, be certain to use a fuse of the proper rating. The DR-1XE requires a 15 A blade fuse.

Connecting External Devices

Connection of an external microphone or PTT switch

By connecting an optional microphone MH-48A6JA to the [MIC] jack on the front panel, voice communications are possible in the mode which is set on the transmitter. Except, when AMS is set on the transmitter, data transmission is not available via the [MIC] jack.

Connection to a personal computer

The provided PC connection cable "SCU-20" and other optional cables can be used to connect the repeater to a personal computer as a COM port.

Use the [ACC] jack at the back of the repeater to connect with the personal computer.

The pin assignments of the [ACC] jack are as follows.

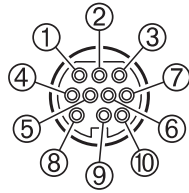

- ① PKD (packet data input)
- ② GND
- ③ PSK (PTT)
- ④ RX 9600 (9600 bps packet data output)
- ⑤ RX 1200 (1200 bps packet data output)
- ⑥ PK SQL (squelch control)
- ⑦ TXD (serial data output [transceiver → PC])
- ⑧ RXD (serial data output [transceiver ← PC])
- ⑨ CTS (data communication control)
- ⑩ RTS (data communication control)

Tips

- Make sure to switch off the power to the radio before connecting the cable.
- When using the PC connection cable "SCU-20", a dedicated driver needs to be installed in the personal computer. Download and use the driver and installation manual from the YAESU website.

Connection to an external controller

To control the DR-1X/DR-1XE remotely, optional cables can be used to connect the repeater to an external controller.

Use the [CONTROL I/O] connector at the back of the repeater to connect with the external controller.

To interface the DR-1X/DR-1XE with an external controller, additional cables with a 15-pin mini d-sub connector are needed to connect to the [CONTROL I/O] connector. Your controller may also require rewiring.

Link operation may require four connections: receiver audio, transmitter audio, receiver COR, and transmitter PTT; however these are not available on the [CONTROL I/O] connector.

The pin assignment of the [CONTROL I/O] connector is as follows.

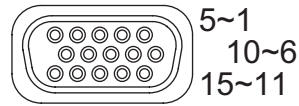

Pin No	Pin Name	I/O	Descriptions
1	EXT I/O	Input	[L] GND: Remote mode [H] OPEN: Repeater mode
2	PTT	Input	[L] GND: EXT PTT ON [H] OPEN: EXT PTT OFF When this pin is pulled low by an external device, it keys the repeater transmitter. Tip On signaling while controlling the external PTT: Pin 6 (TONE IN) ... Valid Pin 7 (AF IN) ... Invalid
3	CTCSS/DCS (PKSQL)	Output	[L] GND: Decoded [H] OPEN: Un-decoded Signaling settings in the repeater setup menu will be applied.
4	SQL DET (Noise SQL)	Output	[L] GND: SQL open [H] OPEN: SQL close This is an open-collector, active-low output capable of sinking about 10 mA. It indicates that the receiver squelch is open. If the squelch control is properly set, this indicates a carrier on the receiver channel.
5	GND	GND	Chassis ground for all logic levels and power supply return
6	TONE IN	Input	CTCSS/DCS EXT input / 600 ohm, 500 mV peak to peak Valid during external PTT control This pin is sub-audible tone input, and has a flat response characteristic (repeater deviation is constant for a given signal level over the frequency range of 5 ~ 250 Hz). Injecting a too high signal level here causes over-deviation of CTCSS or DCS, degrading performance. Use shielded cable to connect to this pin, connecting the shield to GND.
7	AF IN	Input	EXT Modulation input / 600 ohm, 1.5 V peak to peak Valid during external PTT control This pin is audio input (300 ~ 3,000 Hz). This audio is injected before the splatter filter stage, so excess signal input levels are clipped. It is impossible to input analog modulation signals and convert them to digital signals on DR-1X/DR-1XE. Use shielded cable to connect to this pin, and connect the shield to GND. Tip AF IN is usually used for analog modulation input with a packet speed of 1200 bps, however, to input C4FM digital signals for digital modulation operations, enter the DR-1X/DR-1XE Repeater mode, then touch the up-link frequency display area to change the packet speed to 9600 bps.
8	DISC OUT	Output	Up-link RX DISC output (w/o de-emphasis), 500 mV peak to peak Discriminator output during up-link reception. Does not affect the operation mode of the repeater. Received signals with standard deviation produce 500 mVp-p audio (0 ~ 3,000 Hz) are output at this pin. The signal is extracted before the de-emphasis and squelch circuitry. Use shielded cable to connect to this pin, and connect the shield to GND.
9	AF OUT	Output	Up-link RX AF output (w/ de-emphasis), 300 mV peak to peak Analog audio output during up-link reception. Does not affect the operation mode of the repeater. This pin is an output for AF signal (300 mVp-p), being extracted after the de-emphasis. Demodulated digital signals can be output as well.
10	GND	GND	Chassis ground for all logic levels and power supply return

Connecting External Devices

Pin No	Pin Name	I/O	Descriptions																				
11	EXT port 1*1	Input	In Remote mode, the logic combination of Ports 1 and 2 determines the transmit and receive modes as below: <table border="1" style="margin-left: 20px;"> <thead> <tr> <th>Port 2</th> <th>Port 1</th> <th>RX</th> <th>TX</th> </tr> </thead> <tbody> <tr> <td>H</td> <td>H</td> <td>Auto (AMS)</td> <td>FM</td> </tr> <tr> <td>H</td> <td>L</td> <td>FM</td> <td>FM</td> </tr> <tr> <td>L</td> <td>H</td> <td>Digital</td> <td>Digital</td> </tr> <tr> <td>L</td> <td>L</td> <td>Auto (AMS)</td> <td>Auto (AMS)</td> </tr> </tbody> </table>	Port 2	Port 1	RX	TX	H	H	Auto (AMS)	FM	H	L	FM	FM	L	H	Digital	Digital	L	L	Auto (AMS)	Auto (AMS)
Port 2	Port 1	RX		TX																			
H	H	Auto (AMS)		FM																			
H	L	FM		FM																			
L	H	Digital		Digital																			
L	L	Auto (AMS)	Auto (AMS)																				
12	EXT port 2*1	Input																					
13	EXT port 3*1	Input	[L] GND: RX Tone OFF [H] OPEN: Setup mode Input a low level signal to indicate that the receiving tone is invalid.																				
14	EXT port 4*1	Input	[L] GND: TX Tone OFF [H] OPEN: Setup mode Input a low level signal to indicate that the transmitting tone is invalid.																				
15	VCC	VCC	Power supply This pin provides 13.8 V, 2.0 A, DC from the repeater supply. There is an internal 3 A fuse to prevent damage to the repeater.																				

*1: These functions may only be activated while the repeater is in Remote mode.

Pins 6, 7, 8, and 9 Functions Controlled by Operation Mode

Pin No	Pin Name	Receive Mode	In Repeater / Remote Mode
6	TONE IN	Digital	Invalid
		Analog	Invalid
7	AF IN	Digital	Invalid
		Analog	Invalid
8	DISC OUT	Digital	Invalid
		Analog	Discriminator output
9	AF OUT	Digital	Demodulated digital audio output
		Analog	Analog audio output

Caution

Even when using the DR-1X/DR-1XE with an external controller, the COR, analog and digital IDs, TOT, DSC/CTCSS, TX power, etc. are already controlled by the DR-1X/DR-1XE internal control. These internal controls cannot be disabled. The external controller must not conflict with these functions. Some functions of the internal controller cannot be overridden. Before connecting an external controller you must make sure which functions are already internally controlled. Special precautions must be considered when planning to link with external systems.

Tips

- Make sure to switch off the power to the radio before connecting the cable.
- In case of jamming or interfering signal while in Repeater mode, Pin 1 may be grounded by external control to temporarily disable repeating the receiver input.

To use DR-1X/DR-1XE in Remote mode

By setting [REMOTE] in the setup menu to ON and inputting a low level to Pin 1 of the [CONTROL I/O] connector, the repeater may be used in Remote mode and controlled remotely by the external controller. Pins 1, 8, 9, 11, 12, 13 and 14 may be used for input, output and control while in Remote mode.

For details, see "Remote Operation" (Page 25).

Basic Operations

Turning the power on

- 1 Press the “I” side of the POWER switch

The power will be switched on, and the power supply monitor (LED indicator) will illuminate.

- Tips**
- When the power is supplied from the AC IN jack, the indicator illuminates in green (DR-1X only).
 - When the power is supplied through the BACKUP terminals (13.8 V DC), the indicator illuminates in red.

The operation mode screen will appear on the display.

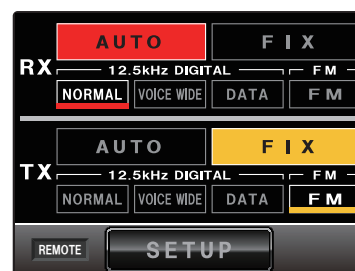
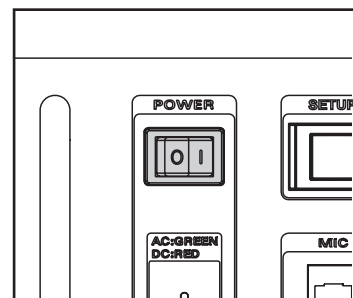

Switching the power off

- 1 Press the “O” side of the POWER switch

The power supply monitor and the display will turn off, and the power will be switched off.

Setting the ID (call sign)

When switching the power on for the first time after purchasing, or after resetting the radio, you must enter the call sign.

- 1 Touch [F] in the setup mode screen

The setup menu will appear.

- 2 Touch [ID SET]

The character input screen will appear.

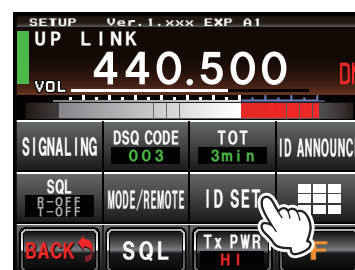

- 3 Touch a character key

The touched character will be displayed at the top of the screen.

- Tips**
- Each time [X] is touched the cursor will move to the left and erase one character.
 - The input screen changes between numbers input and alphabet input each time [ABC] is touched.
 - The cursor in the input field moves left or right when [←] or [→] are touched.
 - Alphabets, numbers, and a hyphen up to 10 characters can be entered.



- 4 Touch [ENT]

The ID setting is saved and the display will return to the setup menu.

- Tip** When switching the power ON for the first time after purchasing, or after resetting the radio, a screen will be displayed requesting the repeater ID be entered.



Turning the display on and off

- 1 Press the SETUP button for 1 second to turn the display off

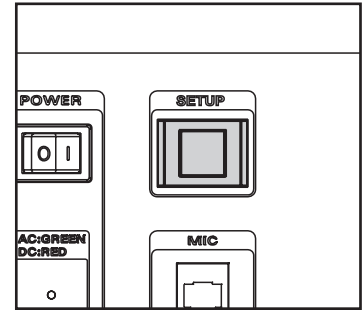

- 2 Press the SETUP button for 3 seconds to turn the display on

Tip The display can be set to turn off automatically after a period of time with no operation. See “Setting the display turn-on time” (Page 37) for details.

Adjusting the volume

- 1 Turn the VOL knob
The monitor speaker audio volume of the received (up link) signal will increase when the knob is turned in a clockwise direction and decrease when the knob is turned in a counter-clockwise direction.

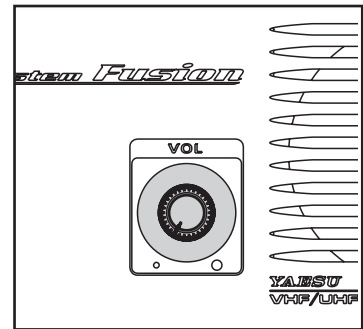

Switching the operating mode

The operating mode can be switched between the AUTO mode in which the communication mode switches automatically corresponding to the received/transmitted signal types, and the FIX mode in which the signals are always received/transmitted in the previously selected communication mode.

Tip

In the factory default, the RX band is set to the AUTO mode, and the TX band to the FIX mode.

- 1 Touch **[AUTO]** to activate the AMS (automatic mode select) function

One of the communication modes will be selected automatically and the corresponding indicator will be displayed in red (also see the next page).

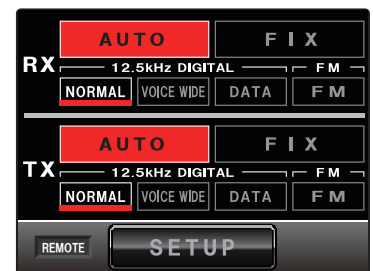
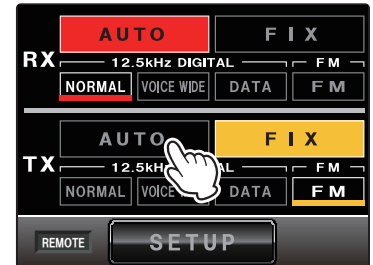

- 2 Touch **[FIX]** to operate in the FIX mode

The indicator of the selected communication mode will turn yellow on the operation mode screen.

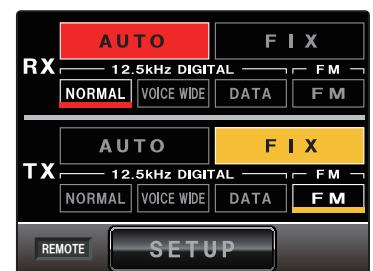

Switching the communication mode

This repeater is equipped with the AMS (automatic mode select) function which automatically selects one of four communication modes to match the signal received or transmitted.

C4FM digital signals or analog signals are identified in order to automatically match the communication mode of the partner station. When using AUTO mode, the AMS function is activated and the selected communication mode is indicated in red on the operation mode screen.

When using FIX mode, touch **[FIX]** repeatedly on the operation mode screen to select the communication mode. The selected mode is indicator in yellow and changes each time **[FIX]** is touched.

Tip The combination of UP LINK for "FIX mode" and DOWN LINK for "AUTO mode" can not be set.

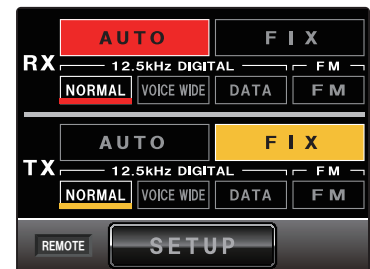
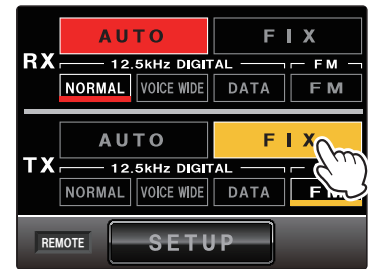

Communication mode	Indicator	Explanation of mode
V/D mode (Simultaneous voice and data communication mode)	NORMAL / DN	The audio signal error is detected and repaired during the transmission of the digital audio signal. This reduces interruptions to the conversation and is the basic C4FM FDMA digital mode.
Voice FR mode (Voice full-rate mode)	VOICE WIDE / VW	Digital voice data is transmitted using the entire 12.5 kHz bandwidth. High quality voice communication is possible.
Data FR mode (High speed data communication mode)	DATA / DW	High speed data communication mode using the entire 12.5 kHz bandwidth for data communication. Automatically switches to this mode for video communication.
Analog FM mode	FM	Analog communications using the FM mode. This mode is effective for communication when the signal strength is so weak that the voice is cut off or interrupted in the digital mode.

Caution

In the V/D mode ("NORMAL" is displayed), the position information is included in the transmitted signal during the conversation, however in the Voice FR mode ("VOICE WIDE" is displayed), the position information is not included.

Adjusting the squelch level

Annoying noises can be muted when no signal is detected. The noise can be canceled more effectively when the squelch threshold is increased, but it may become more difficult to receive weak signals. Adjust the squelch level as required.

Note When the squelch level is set to "open" the repeater will transmit, it must be connected to the duplexer and antenna. Use extreme caution when making the squelch adjustment or measurement with a signal generator. Do not connect the signal generator to the duplexer antenna port. To avoid damaging the test equipment, connect the signal generator directly to the RX antenna connector on the DR-1X/DR-1XE.

1 Touch **[SETUP]**

The setup mode screen will appear.

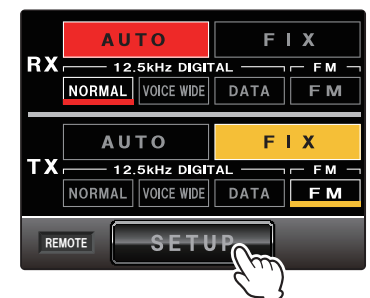

2 Touch [SQL]

When [SQL] turns orange, the VOL meter below the frequency of the RX band will change to the SQL meter showing the squelch level setting.

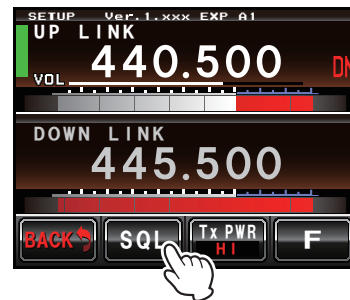

3 Touch [▲] or [▼] to adjust the squelch level

The level will be displayed in the SQL meter.

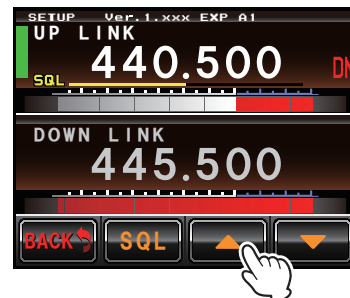

4 Touch [BACK]

The squelch level is set and the display will return to the previous screen.

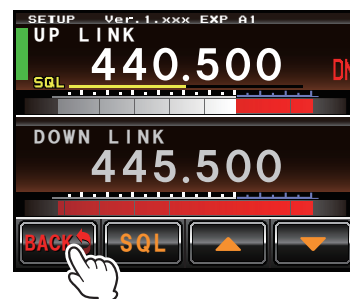

Adjusting the transmit power

The transmit power can be reduced to save on power consumption.

1 Touch [SETUP]

The setup mode screen will appear.

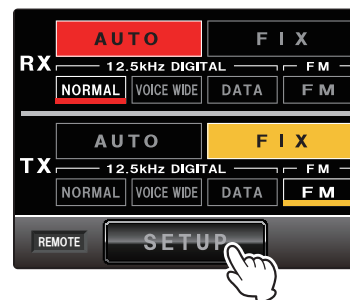

2 Touch [Tx PWR] to select the transmit power

The setting is changed in the following sequence, each time [Tx PWP] is touched.

“HI” → “LO” → “MD”

HI	MD	LO
50 W	20 W	5 W

- Tips**
- The current setting is displayed below [Tx PWR] on the screen.
 - Factory default: HI

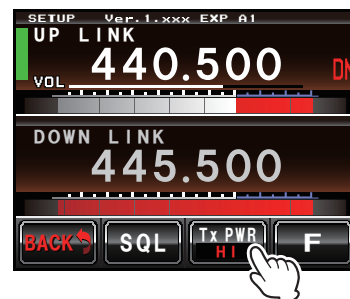

3 Touch [BACK]

The transmit power level is set and the display will return to the operation mode screen.

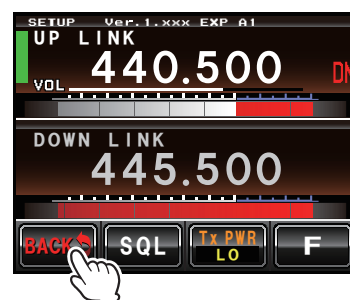

Setting the TX Inhibit

- 1 Touch **[SETUP]** on the operation mode screen
The setup mode screen will appear.
- 2 Touch **[F]** in the setup mode screen
The setup menu will appear.
- 3 Touch **[MODE/REMOTE]**
The menu list will appear.

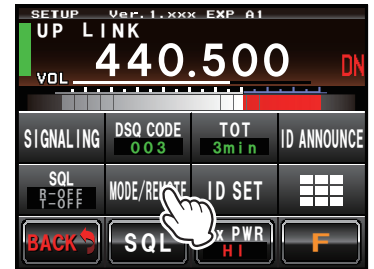

- 4 Select **[TX INHIBIT]**

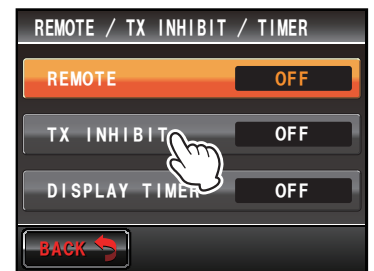

- 5 Touch **[TX INHIBIT]**
The set value will change between **[OFF]** and **[ON]** each time it is touched.

ON	OFF
Disable transmission	Enable transmission

Tip Factory default: OFF

Note When [TX INHIBIT] is set to "ON", all transmit action will be disabled.

- 6 Touch **[BACK]**
The setting is saved and the display will return to the setup menu.

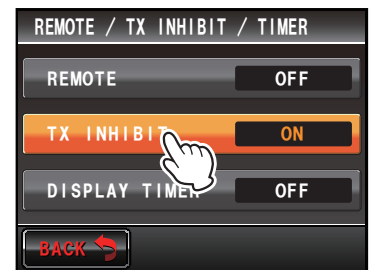

Remote Operation

You can control the repeater operation remotely by connecting an external controller through the [CONTROL I/O] connector at the back of the repeater (see “Connection to an external controller” (Page 17)).

The following features are available while in remote operation:

- Changing the communication mode of repeater transmission and reception
- Turning the RX and TX tone signal “ON” or “OFF”
- Monitoring the discriminator and analog or demodulated digital audio during up-link reception

To use the repeater under remote control, set up the repeater as explained below, after it is connected to the external controller.

Turning remote operation ON/OFF

When the remote operation is “ON”, the repeater operates according to the control instructions received from the external controller (the instructions are received through Pin 11 to Pin 14 of the [CONTROL I/O] connector). When the remote operation is “OFF”, the repeater operates according to the settings determined through the setup mode.

1 Touch [SETUP]

The setup mode screen will appear.

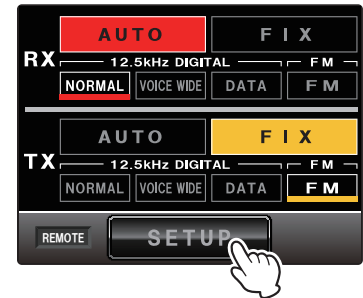

2 Touch [F]

The setup menu will appear.

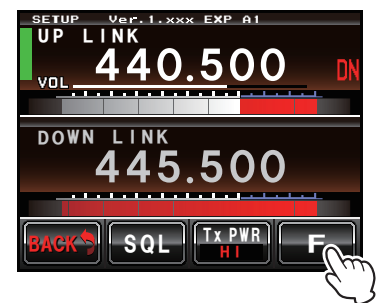

3 Touch [MODE/REMOTE]

The menu list will appear.

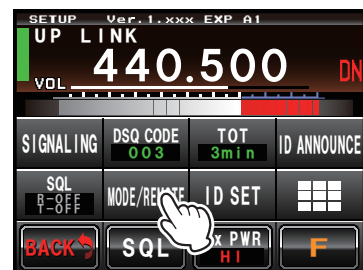

4 Select and touch [REMOTE]

The set value will change between [OFF] and [ON] each time it is touched.

Tip Factory default: OFF

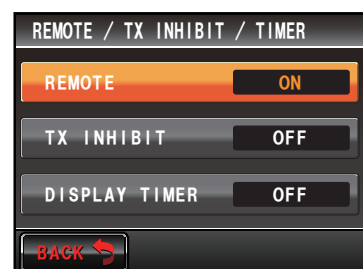
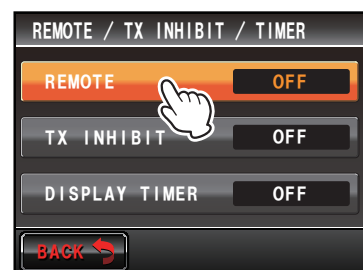

5 Touch [BACK] three times

The setting is determined and the display will return to the operation mode screen.

Note that [REMOTE] at the bottom left of the screen is displayed in red.

Control from external controller

Your external controller must generate and accept the following signals through a connection cable with a 15-pin mini d-sub connector corresponding to the [CONTROL I/O] connector of the repeater.

Caution

Do not use a VGA cable for PC display to connect your external controller to the repeater.

Pin No	Pin Name	I/O	Descriptions and Settings																				
1	EXT I/O	Input	L (GND) Mode selection. Fix this input to low level to enable remote operation.																				
2	PTT	Input	L (GND): EXT PTT ON H (OPEN): EXT PTT OFF When this pin is pulled low by an external device, it keys the repeater transmitter. Tip On signaling while controlling the external PTT: Pin 6 (TONE IN) ... Valid Pin 7 (AF IN) ... Invalid																				
3	CTCSS/DCS (PKSQL)	Output	L (GND): Decoded H (OPEN): Un-decoded Signaling settings in the repeater setup menu will be applied.																				
4	SQL DET (Noise SQL)	Output	L (GND): SQL open H (OPEN): SQL close This indicates whether the receiver squelch is open. If the squelch control is properly set, this indicates a carrier on the receiver channel.																				
5	GND	GND	Chassis ground for all logic levels and power supply return																				
6	TONE IN	Input	CTCSS/DCS EXT input / 600 ohm, 500 mV peak to peak Valid during external PTT control																				
7	AF IN	Input	EXT Modulation input / 600 ohm, 1.5 V peak to peak Valid during external PTT control Caution It is impossible to input analog modulation signals and convert them to digital signals on DR-1X/DR-1XE. Tip AF IN is usually used for analog modulation input with a packet speed of 1200 bps, however, to input C4FM digital signals for digital modulation operations, enter the DR-1X/DR-1XE Repeater mode, then touch the up-link frequency display area to change the packet speed to 9600bps (see the next page).																				
8	DISC OUT	Output	Up-link RX DISC output (w/o de-emphasis), 500 mV peak to peak Discriminator output during up-link reception																				
9	AF OUT	Output	Up-link RX AF output (w/ de-emphasis), 300 mV peak to peak Analog or demodulated digital audio output during up-link reception																				
10	GND	GND	Chassis ground for all logic levels and power supply return																				
11	EXT port 1	Input	The logic combination of these two pins determines the communication mode of transmission and reception as below:																				
12	EXT port 2	Input																					
<table border="1"> <thead> <tr> <th>Port 2</th> <th>Port 1</th> <th>RX</th> <th>TX</th> </tr> </thead> <tbody> <tr> <td>H</td> <td>H</td> <td>Auto (AMS)</td> <td>FM</td> </tr> <tr> <td>H</td> <td>L</td> <td>FM</td> <td>FM</td> </tr> <tr> <td>L</td> <td>H</td> <td>Digital</td> <td>Digital</td> </tr> <tr> <td>L</td> <td>L</td> <td>Auto (AMS)</td> <td>Auto (AMS)</td> </tr> </tbody> </table>				Port 2	Port 1	RX	TX	H	H	Auto (AMS)	FM	H	L	FM	FM	L	H	Digital	Digital	L	L	Auto (AMS)	Auto (AMS)
Port 2	Port 1	RX	TX																				
H	H	Auto (AMS)	FM																				
H	L	FM	FM																				
L	H	Digital	Digital																				
L	L	Auto (AMS)	Auto (AMS)																				
13	EXT port 3	Input	L (GND): RX Tone OFF H (OPEN): RX Tone ON (with signal type set in the setup mode) Input a low level signal to indicate that the receiving tone is invalid.																				
14	EXT port 4	Input	L (GND): TX Tone OFF H (OPEN): TX Tone ON (with signal type set in the setup mode) Input a low level signal to indicate that the transmitting tone is invalid.																				
15	VCC	VCC	Power supply (13.8 V DC)																				

Base Station Operation

You can use the repeater as a VHF/UHF base station by connecting an optional MH-48A6JA microphone to the [MIC] jack on the front panel.

Transmitting C4FM digital signals

For digital modulation operation, the packet speed (data transmission rate) of the repeater must be set to 9600 bps, remember to change the default setting from 1200 bps.

If the repeater is expected to transmit digital modulation signals while in base station operation, set the packet speed to 9600 bps before starting base station operation as below.

- 1 Touch **[SETUP]** on the operation mode screen
The setup mode screen will appear.
- 2 Touch **[F]**
The setup menu will appear.
- 3 Touch the up-link frequency display area
"Packet Speed 9600bps" will appear for a while.

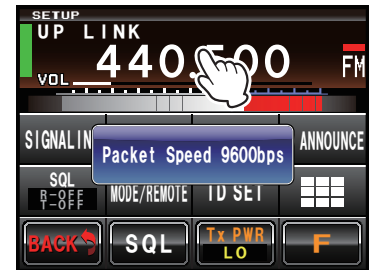

- 4 Touch **[BACK]**
The display will return to the setup mode screen.

Setting up the Repeater

Using the setup menu, the various functions of the repeater can be customized to match the method of use. You can select the items that you would like to adjust from the respective lists and enter or select the appropriate settings for the intended repeater operation.

Setup menu basic operations

- 1 Touch **[SETUP]** on the operation mode screen
The setup mode screen will appear.
- 2 Touch **[F]**
The setup menu will appear.
- 3 Touch the menu item
The menu list will appear.
- 4 Touch the item to be set
The item will turn orange in color.
- 5 Touch **[▲]** or **[▼]**, or touch the item repeatedly
The set value will change each time it is touched.
- 6 Touch **[BACK]**
The setting is determined and the display will return to the setup menu.

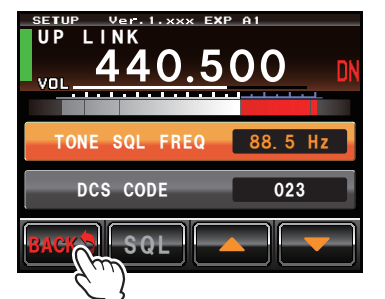
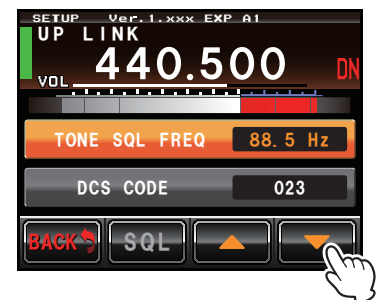
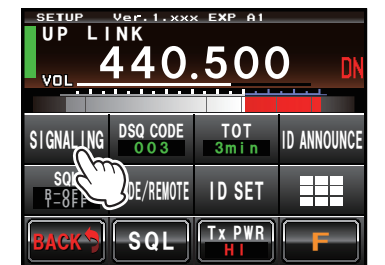
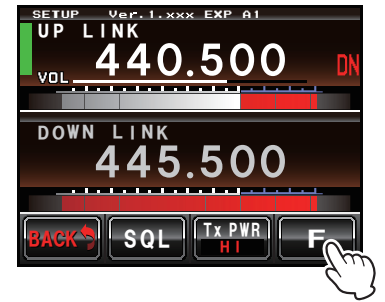

Setting the frequency

- 1 Touch the TX or RX band area.
The number input screen will appear.

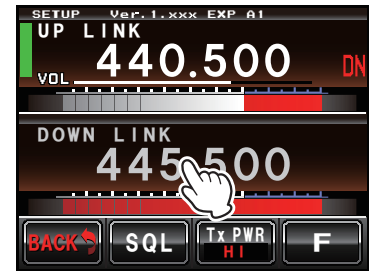

- 2 Touch a number key
The touched number will be displayed at the top of the screen.

- Tips**
- Each time [**X**] is touched the cursor will move to the left and erase one character.
 - Touch the "DOWN LINK" or "UP LINK" area to change the frequency setting between TX or RX.
 - When the last digit is entered, the display will return to the setup menu.
 - The entered frequency will be displayed on the selected band.

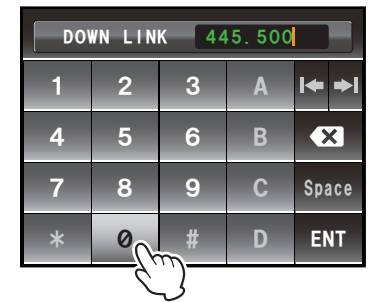

- 3 Touch [**ENT**]
The display will return to the setup menu.
The entered frequency will be displayed on the selected band.

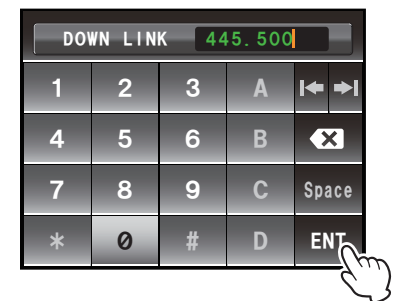

Setting the tone signals

Setting the tone frequency

1 Touch **[F]** in the setup mode screen
The setup menu will appear.

2 Touch **[SIGNALING]**
The menu list will appear.

3 Select **[TONE SQL FREQ]**

4 Touch **[▲]** or **[▼]**
The set value will change each time it is touched.

- Tips**
- Tone frequencies between 67.0 Hz and 254.1 Hz can be selected.
 - Factory default: 100.0 Hz

5 Touch **[BACK]**
The setting is determined and the display will return to the setup menu.

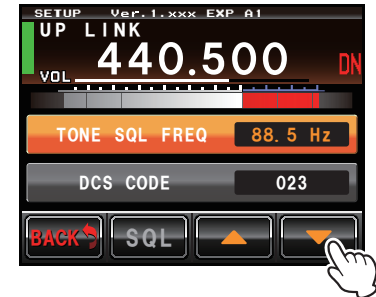
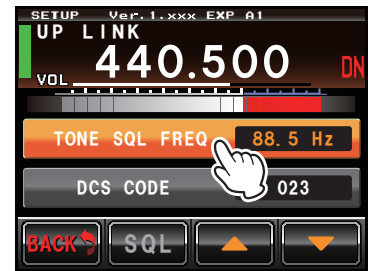

Setting the DCS code

1 Touch **[F]** in the setup mode screen
The setup menu will appear.

2 Touch **[SIGNALING]**
The menu list will appear.

3 Select **[DCS CODE]**

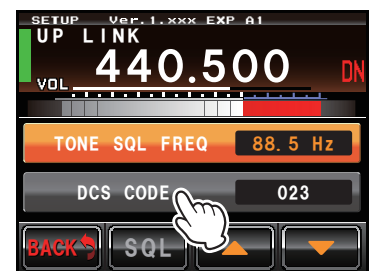
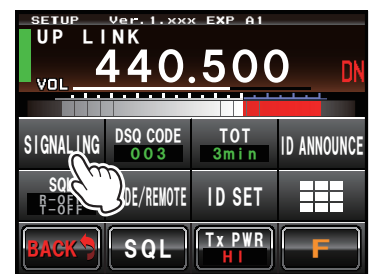

4 Touch [▲] or [▼]

The set value will change each time it is touched.

- Tip** • DCS codes between 023 and 754 can be selected.
- Factory default: 023

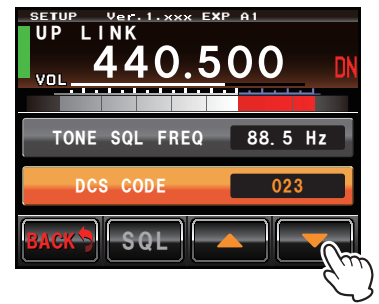

5 Touch [BACK]

The setting is determined and the display will return to the setup menu.

Switching the tone signal types

1 Touch [F] in the setup mode screen

The setup menu will appear.

2 Touch [SQL] in the setup menu

The menu list will appear.

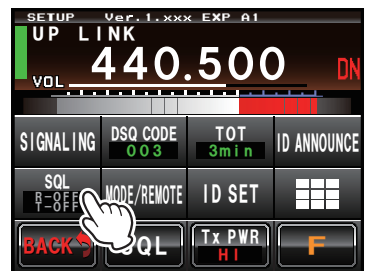

3 Select [RX SQL] to set the tone signal type during reception, or select [TX SQL] to set the tone signal type during transmission

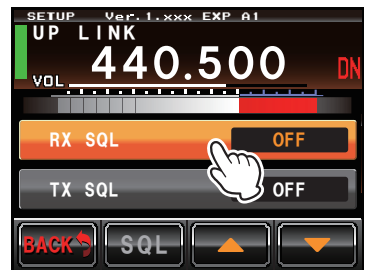

4 Touch [▲] or [▼]

The setting will change in the following sequence each time it is touched.

“OFF” → “TONE” → “DCS”

- Tip** Factory default: OFF

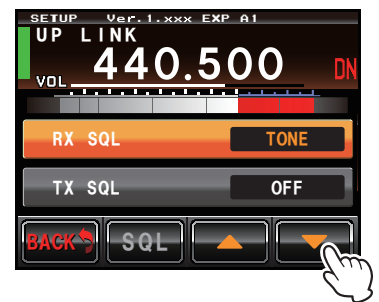

5 Touch [BACK]

The setting is determined and the display will return to the setup menu.

Setting the digital squelch code

1 Touch **[F]** in the setup mode screen
The setup menu will appear.

2 Touch **[DSQ CODE]**
The menu list will appear.

3 Touch **[▲]** or **[▼]**
The set value will change each time it is touched.

- Tips**
- Tone squelch codes between 001 and 126 or OFF can be selected.
 - Factory default: OFF

4 Touch **[BACK]**
The setting is determined and the display will return to the setup menu.
The set value will be displayed below **[DSQ CODE]** on the menu.

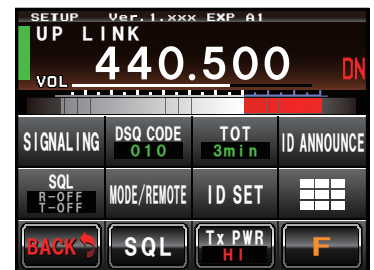
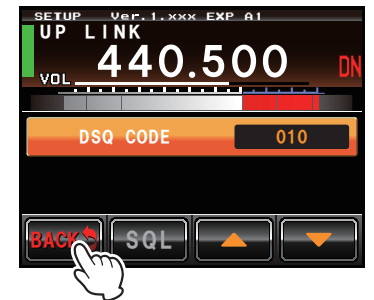
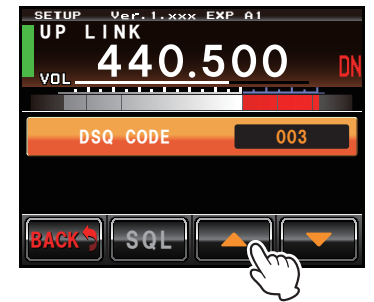
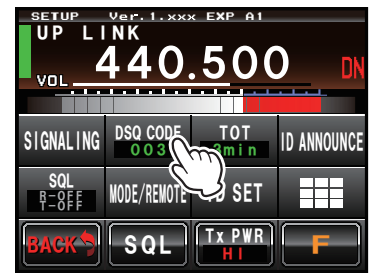

Setting the ID (call sign)

1 Touch **[F]** in the setup mode screen
The setup menu will appear.

2 Touch **[ID SET]**
The character input screen will appear.

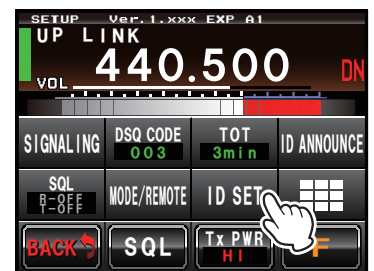

3 Touch a character key

The touched character will be displayed at the top of the screen.

- Tips**
- One character to the left of the cursor is erased when [X] is touched.
 - The screen changes to the input screen for numbers and alphabet each time [ABC] is touched.
 - The cursor in the input field moves left and right when [←] and [→] are touched.
 - Alphabets, numbers, and a hyphen up to 10 characters can be entered.

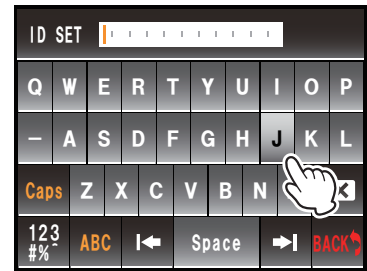

4 Touch [ENT]

The setting is determined and the display will return to the setup menu.

- Tip** When switching the power ON for the first time after purchasing, or after resetting the radio, a screen will be displayed requesting the repeater ID entered.



Setting the ID announcement

Setting the way to announce

- 1 Touch [F] in the setup mode screen
The setup menu will appear.
- 2 Touch [ID ANNOUNCE]
The menu list will appear.

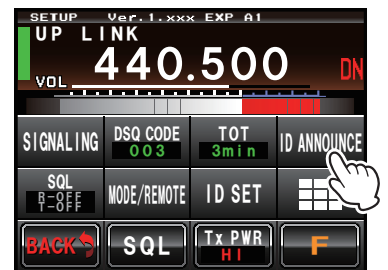

- 3 Select and touch [ANNOUNCE]
The menu list will appear.



- 4 Select and touch [ANNOUNCE MODE]
The set value will change between [CW] and [VOICE] each time it is touched.
Caution [VOICE] cannot be selected when the optional voice guide unit "FVS-2" is not mounted on the repeater.
Tip Factory default: CW



- 5 Touch [BACK]
The setting is determined and the display will return to the menu list.

Setting the announcement output level

- 1 Touch **[F]** in the setup mode screen
The setup menu will appear.
- 2 Touch **[ID ANNOUNCE]**
The menu list will appear.

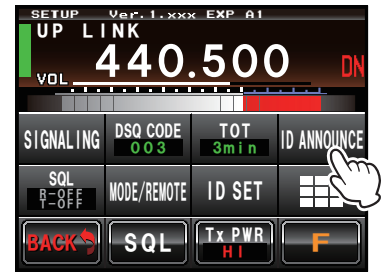

- 3 Select and touch **[ANNOUNCE]**
The menu list will appear.



- 4 Select and touch **[ANNOUNCE LEVEL]**
The set value will change in the following sequence each time it is touched.
“HIGH” → “MID” → “LOW”

Tip Factory default: MID



- 5 Touch **[BACK]**
The setting is determined and the display will return to the menu list.

Setting the ID announcement CW speed

- 1 Touch **[F]** in the setup mode screen
The setup menu will appear.
- 2 Touch **[ID ANNOUNCE]**
The menu list will appear.

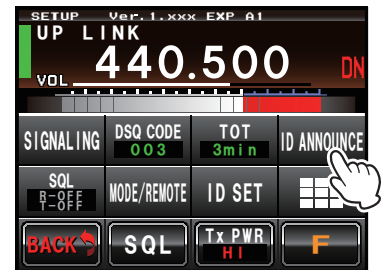

- 3 Select and touch **[ANNOUNCE]**
The menu list will appear.



4 Select and touch **[CW ID SPEED]**

The set value will change in the following sequence each time it is touched.
 “16wd/min” → “18wd/min” → “20wd/min” → “22wd/min” → “24wd/min”

Tip Factory default: 20wd/min

Note When operating in the USA the CW ID SPEED setting time must not exceed 20 words per minute when keyed by an automatic device, to comply with the FCC rule Part 97: Sec. 97.119 (b)(1) Station identification.



5 Touch **[BACK]**

The setting is determined and the display will return to the menu list.

Setting the announcement time interval

1 Touch **[F]** in the setup mode screen

The setup menu will appear.

2 Touch **[ID ANNOUNCE]**

The menu list will appear.

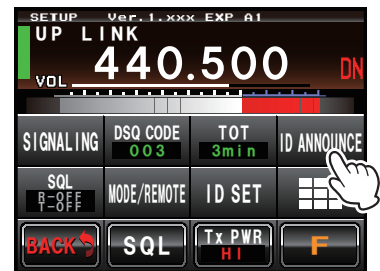

3 Select **[INTERVAL]**



4 Touch **[▲]** or **[▼]**

The set value will change in the following sequence each time it is touched.
 “OFF” → “3min” → “5min” → “10min” → “15min” → “20min” → “30min” → “TOT”

Tip Factory default: 10min

Note When operating in the USA, the ID setting time should be ten minutes or less to comply with the FCC rule Part 97: Sec. 97.119 (a) Station identification.

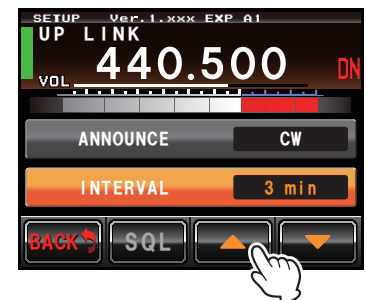

5 Touch **[BACK]**

The setting is determined and the display will return to the setup menu.

Setting the TOT (timeout timer)

- 1 Touch [F] in the setup mode screen
The setup menu will appear.
- 2 Touch [TOT]
The menu list will appear.

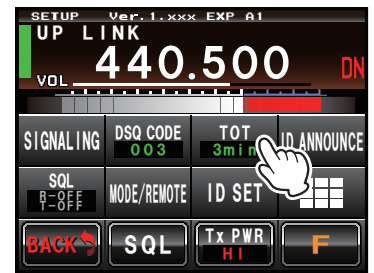

- 3 Touch [▲] or [▼]
The set value will change in the following sequence each time it is touched.
“OFF” → “30sec” → “1min” → “1.5min” → “2min” → “2.5min” → “3min” → “4min” → “5min” → “10min”

Tip Factory default: 3min

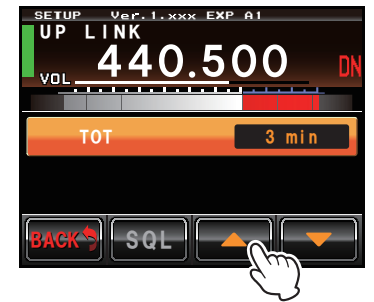

- 4 Touch [BACK]
The setting is determined and the display will return to the setup menu.
The set value will be displayed below [TOT] on the menu.

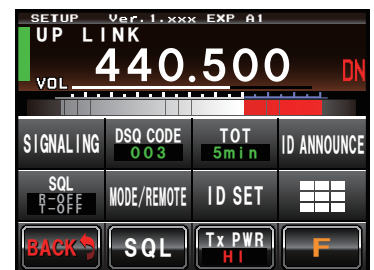
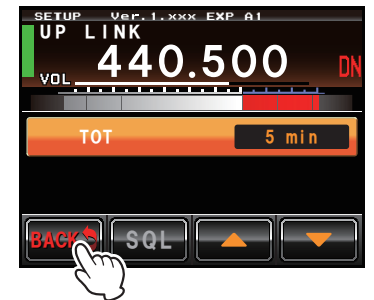

Setting other configuration

Setting the repeater for remote operation

See page 24 for details.

Turning transmission ON/OFF from the remote controller

See page 23 for details.

Setting the display turn-on time

- 1 Touch **[F]** in the setup mode screen
The setup menu will appear.
- 2 Touch **[MODE/REMOTE]**
The menu list will appear.
- 3 Select **[DISPLAY TIMER]**
- 4 Touch **[DISPLAY TIMER]**
The set value will change in the following sequence each time it is touched.
“CONTINUE” → “1min” → “5min” → “10min” → “30min”
Tip Factory default: CONTINUE
- 5 Touch **[BACK]**
The setting is determined and the display will return to the menu list.

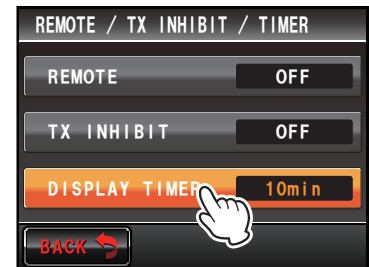
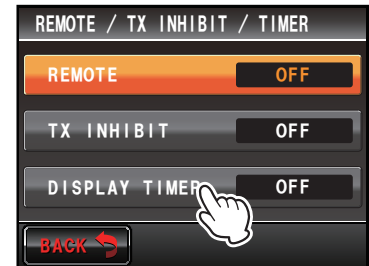
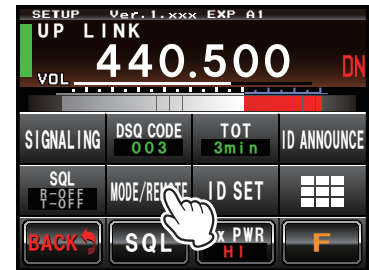

Setting the Packet Speed

- 1 Touch **[F]** in the setup mode screen
The setup menu will appear.
- 2 Touch the RX band area.
The set value will change between [1200 bps] and [9600 bps] each time it is touched.
Tip Factory default: 1200 bps
- 3 Three seconds after selecting the packet speed, the new setting is automatically saved and the display will return to the menu list.

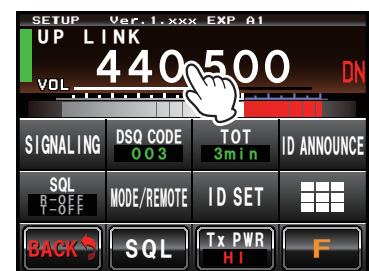

Restoring Default Settings (Factory Reset)

- 1 Turn the radio off.
- 2 Press and hold in the SETUP button while turning the radio on.
Tip Continue pressing the SETUP button until the operation mode screen appears on the display.

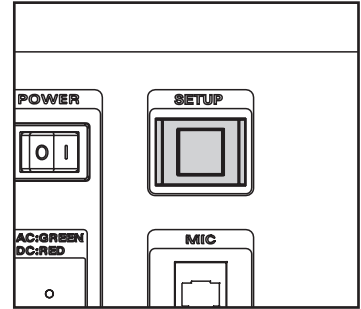

- 3 Touch [SETUP]
The setup mode screen will appear.
- 4 Touch [F] in the setup mode screen
The setup menu will appear.
- 5 Touch [F]
The reset confirmation screen will appear.

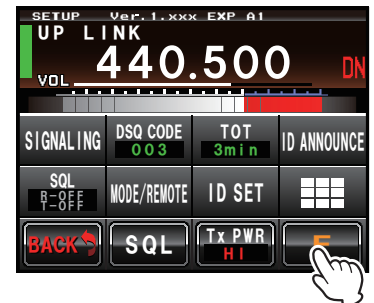

- 6 Touch [OK?]
The settings will be reset to the factory default values.
Tips
 - Touch [Cancel] to stop the reset and keep the current settings.
 - After resetting the repeater, the call sign must be entered (see page 32).



Installation of the Optional Voice Guide Unit "FVS-2"

- 1 Turn the DR-1X/DR-1XE [POWER] switch to "OFF".
- 2 Disconnect all the cables from the DR-1X/DR-1XE.
- 3 Referring to Figure 1, remove the 4 screws from each side and 7 screws from the top cover of the DR-1X/DR-1XE, then remove the top cover.

Note Figures in this page show the outline of the DR-1X.

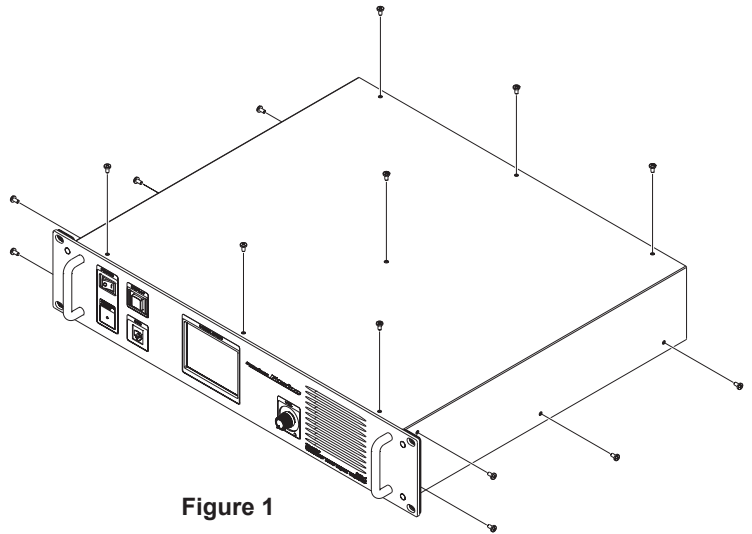

Figure 1

- 4 Referring to Figure 2, remove the 4 screws from the top cover of the RX-Unit, then remove the top cover.

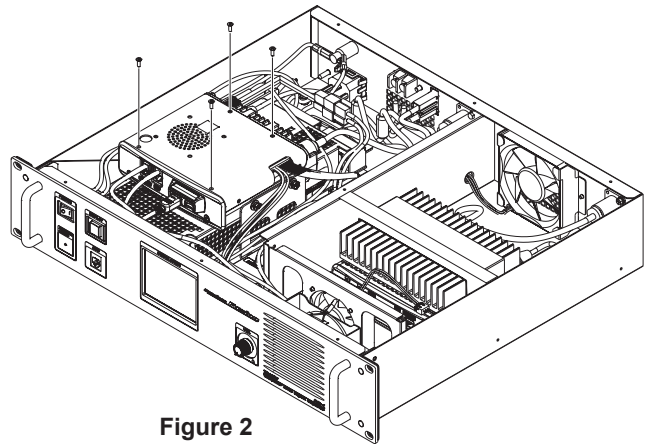

Figure 2

- 5 Refer to Figure 3 for the mounting location for the FVS-2.

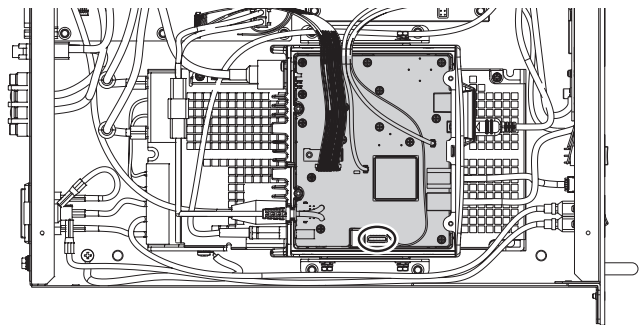

Figure 3

- 6 Push the FVS-2 (component side up) onto the pins corresponding to its assigned mounting location on the DR-1X/DR-1XE.
Gently press the FVS-2 down until it is firmly seated on the connector.

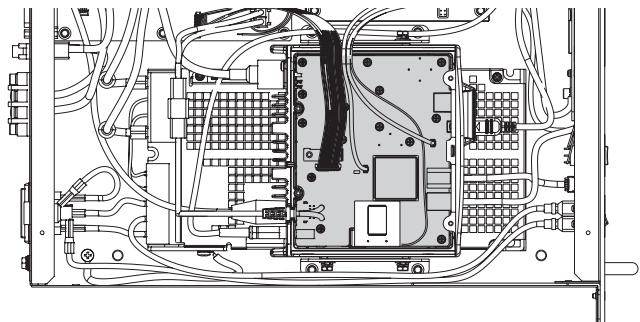

Figure 4

- 7 Replace the top cover of the RX-Unit and the 4 screws.
- 8 Replace the top cover of the DR-1X/DR-1XE and 15 screws.
- 9 Connect all the cables to the DR-1X/DR-1XE.

Maintenance

Care and maintenance

Switch the power supply OFF before wiping away any dust and stains on the radio using a dry and soft cloth. For stubborn stains, wet a piece of soft cloth and wring it hard before using it to wipe away the stains.

Caution Never use washing detergents or organic solvents (thinner, benzene etc.). These may result in the paint peeling off or the cover being damaged.

Replacing the fuse

When the fuses attached at the rear of the radio are blown and the radio can no longer operate, replace them with correct rating one (5 A for AC power supply (DR-1X only), 15 A for DC power supply).

Caution When replacing the fuse, disconnect the power supply cable from the radio.

Advice When There Is a Problem

Caution

Check the following before requesting repair services.

There is no power

- Is the external power supply connected correctly?
Check the AC power supply (DR-1X only); plug the connectors of the provided power supply cable all the way into the jacks.
Check the DC power supply; connect the black wire to the minus terminal and the red wire to the plus terminal.
- Is the voltage and current capacity of the external power supply sufficient?
Check the voltage and current capacity of the external power supply.
- Is the fuse open/blown?
Replace the fuse.

There is no sound

- Is the squelch level or setting too high?
Adjust the squelch level when receiving weak signals.
- Is the volume too low?
Increase the volume by turning the VOL knob in a clockwise direction.
- Is the tone squelch or DCS turned on?
When the tone squelch or DCS is turned on, no sound will be heard until signals containing the same tone frequency or DCS code as the repeater setting are received.

There is no transmission

- Is the transmit frequency set to the amateur band?
Transmission outside the amateur band is not possible.
- Is the antenna or coaxial cable at fault?
Replace the antenna or coaxial cable.
- Is the voltage of the external power supply normal?
When the voltage of the power supply drops during transmission, the radio may not function correctly.
Use a stable power supply with a proper voltage and current capacity.

There is no screen on the display

- Is the screen timeout timer set to ON?
Press and hold the SETUP button for 3 seconds to turn on the display.
Set a longer period of time for the timeout timer in the setup mode.

About internal spurious signals

Due to the combination of oscillator signals produced at the same time in the receiver, there may be some internal heterodynes due to the high frequency of the internal oscillator. However, this is not a malfunction (refer to the calculation formula below: n is any integer). Depending on the combination of the frequencies received at the same time, there may also be fluctuations in the reception sensitivity.

- Reception frequency = 12.288 MHz x n times
- Reception frequency = 2.4576 MHz x n times
- Reception frequency = 11.1 MHz x n times
- Upper (Band A) frequency = (Lower (Band B) frequency ± 44.85 MHz) × n times
- Lower (Band B) frequency = (Upper (Band A) frequency ± 47.25 MHz) × n times @ Upper band (Band A) MODE = NFM
- Reception frequency = 15.6 MHz x n times
- Reception frequency = 6.1444 MHz x n times
- Reception frequency = 18.432 MHz x n times

After-market Services

○ The warranty period is 1 year or 2 years from the date of purchase

The warranty certificate is enclosed with the product. Malfunction arising during normal use of the product in accordance with the instructions in the operating manual, within a period of 1 year (DR-1X) or 2 years (DR-1XE) from the date of purchase, shall be repaired free-of-charge.

○ Keep the warranty certificate in a safe location

When the warranty certificate is lost, failures which occur during the warranty period will be treated as chargeable non-warranty claims.

A warranty certificate where the necessary information such as the purchase date and the name of the retail store have not been filled in will also be treated as void. Please ensure that the date of purchase and the name of the retail store are filled in correctly on the warranty certificate.

○ You may also check with us for any non-warranty repairs

We will make repairs at your expense if the functions can be reliably maintained after the repairs. Please check with the retail store or Yaesu customer support for more information.

○ Save the packaging box

When sending this product for inspection and repair, use the original product packaging box to prevent shipping damages during the transport.

Specifications

● General

Frequency range	: 144 to 146 MHz, 430 to 440 MHz 144 to 148 MHz, 430 to 450 MHz
Channel steps	: 5 / 6.25 kHz
Emission type	: F1D, F2A, F2D, F3E, F7W
Frequency stability	: ± 2.5 ppm (-4°F to $+140^{\circ}\text{F}$ (-20°C to $+60^{\circ}\text{C}$))
Antenna impedance	: 50 Ω
Supply voltage	: AC 100 to 240 V (DR-1X) DC 11.7 to 15.8 V, negative grounding
Current consumption	: AC: 2 A (max) (@ 117 V Input) (DR-1X) DC: 1.5 A (receive) 10 A (50 W TX, 144 MHz band) 10 A (50 W TX, 430 MHz band)
Operating temperature	: DR-1X: -4°F to $+140^{\circ}\text{F}$ (-20°C to $+60^{\circ}\text{C}$) DR-1XE: -20°C to $+55^{\circ}\text{C}$
Dimensions	: 19" (W) \times 3.5" (H) \times 15" (D) (482 \times 88 \times 380 mm)
Weight (approx.)	: DR-1X: 22.05 lbs (10 kg) DR-1XE: 8.8 kg

● Transmitter

RF power output	: 50 / 20 / 5 W
Modulation type	: F1D, F2A, F2D, F3E Variable Reactance Modulation F7W 4FSK (C4FM)
Spurious emission	: At least 60 dB below

● Receiver

Circuit type	: Double conversion super-heterodyne
Intermediate frequencies	: 1st: 47.25 MHz, 2nd: 450 kHz
Receiver sensitivity	: 0.3 μV (Digital 2 m/70 cm) BER 1 % 0.2 μV (FM 2 m/70 cm) 12 dB SINARD
Adjacent Channel Selectivity	: Better than 65 dB TYP (20 kHz offset)
Selectivity	: FM 12 kHz/35 kHz (-6 dB/ -60 dB)
Intermodulation	: Better than 65 dB TYP (20 /40 kHz offset)
Audio output	: 4 W (4 Ω , THD 10%, 13.8 V; internal speaker)

Cautions

- Rated values are at normal temperature and pressure.
- Ratings and specifications are subject to change without notice for product improvement reasons.

This equipment has been tested and found to comply with the limits for a Class B digital device, pursuant to Part 15 of the FCC Rules. These limits are designed to provide reasonable protection against harmful interference in a residential installation. This equipment generates, uses and can radiate radio frequency energy and, if not installed and used in accordance with the instructions, may cause harmful interference to radio communications. However, there is no guarantee that interference will not occur in a particular installation.

If this equipment does cause harmful interference to radio or television reception, which can be determined by turning the equipment off and on, the user is encouraged to try to correct the interference by one or more of the following measures:

- Increase the separation between the equipment and receiver.
- Connect the equipment into an outlet on a circuit different from that to which the receiver is connected.
- Consult the dealer or an experienced radio/TV technician for help.

This device complies with part 15 of the FCC Rules. Operation is subject to the following two conditions: (1) This device may not cause harmful interference, and (2) this device must accept any interference received, including interference that may cause undesired operation.

Declaration of Conformity

We, Yaesu UK Ltd. declare under our sole responsibility that the following equipment complies with the essential requirements of the Directive 1999/5/EC and Directive 2011/65/EU.

Type of Equipment:	VHF/UHF AMS Digital / Analogue Repeater
Brand Name:	YAESU
Model Number:	DR-1XE
Manufacturer:	YAESU MUSEN CO., LTD.
Address of Manufacturer:	Tennozu Parkside Building, 2-5-8 Higashi-Shinagawa, Shinagawa-ku, Tokyo, 140-0002 Japan

Applicable Standards:

This equipment is tested and conforms to the essential requirements of directive, as included in following standards.

Health 1999/5/EC Art.3 (1) (a)	EN 62311:2008
Safety 1999/5/EC Art. 3 (1) (a)	EN 60950-1:2006+A12:2011
EMC 1999/5/EC Art. 3 (1) (b)	EN 301 489-01 V1.9.2 EN 301 489-15 V1.2.1
Radio Spectrum: 1999/5/EC Art. 3 (2)	EN 301 783-02 V1.2.1
RoHS2 2011/65/EU Art. 7 (b)	EN 50581 :2012

The technical documentation as required by the Conformity Assessment procedures is kept at the following address:

Company: Yaesu UK Ltd.
Address: Unit 12, Sun Valley Business Park, Winnall Close, Winchester
Hampshire, SO23 0LB, U.K.

Disposal of your Electronic and Electric Equipment

Products with the symbol (crossed-out wheeled bin) cannot be disposed as household waste. Electronic and Electric Equipment should be recycled at a facility capable of handling these items and their waste by products.

In EU countries, please contact your local equipment supplier representative or service center for information about the waste collection system in your country.



Attention in case of use

This transceiver works on frequencies which are not generally permitted. As for the actual usage, the user has to possess an amateur radio licence. Usage is allowed only in the frequency bands which are allocated for amateur radios.

List of national codes					
AT	BE	BG	CY	CZ	DE
DK	ES	EE	FI	FR	GB
GR	HR	HU	IE	IT	LT
LU	LV	MT	NL	PL	PT
RO	SK	SI	SE	CH	IS
LI	NO	-	-	-	-

YAESU

The radio

YAESU MUSEN CO., LTD.

Tennozu Parkside Building
2-5-8 Higashi-Shinagawa, Shinagawa-ku, Tokyo
140-0002 Japan

YAESU USA

6125 Phyllis Drive, Cypress, CA 90630, U.S.A.

YAESU UK

Unit 12, Sun Valley Business Park, Winnall Close
Winchester, Hampshire, SO23 0LB, U.K.

Copyright 2014
YAESU MUSEN CO., LTD.
All rights reserved.
No portion of this manual
may be reproduced
without the permission of
YAESU MUSEN CO., LTD.



1406J-0S Printed in Japan

