

# FT-920

# OPERATING MANUAL

**YAESU MUSEN CO., LTD.**

1-20-2 Shimomaruko, Ota-Ku, Tokyo 146-8649, Japan

**YAESU U.S.A.**

17210 Edwards Rd., Cerritos, CA 90703, U.S.A.

**YAESU EUROPE B.V.**

Snipweg 3, 1118DN Schiphol, The Netherlands

**YAESU UK LTD.**

Unit 12, Sun Valley Business Park, Winnall Trading Estate  
Winchester, Hampshire, SO23 0LB, U.K.

**YAESU GERMANY GmbH**

Am Kronberger Hang 2, D-65824 Schwalbach, Germany

**YAESU HK LTD.**

11th Floor Tsim Sha Tsui Centre, 66 Mody Rd.,  
Tsim Sha Tsui East, Kowloon, Hong Kong

# Table of Contents

<b>General Description</b> .....	1	Transmitting .....	47
<b>Specifications</b> .....	2	Automatic Antenna Matching .....	47
<b>Accessories &amp; Options</b> .....	4	SSB Transmission .....	49
<b>Plug Pinout</b> .....	5	Basic Operation .....	49
<b>Installation</b> .....	6	VOX Operation .....	49
Preliminary Inspection .....	6	Digital Speech Processor Operation .....	49
DC Power Connections .....	6	DSP Voice Pattern Contours .....	50
Transceiver Location .....	8	Voice Monitor Operation .....	50
Grounding .....	8	Digital Voice Recorder Operation (Transmit) ..	50
Antenna Considerations .....	9	Linear Amplifier Tuning .....	51
Memory Backup .....	9	CW Transmission .....	51
Adjusting the Front Feet .....	10	Straight Key Operation .....	51
<b>Safety Precautions</b> .....	11	Electronic Keyer Operation .....	52
1. Power Connections .....	11	Memory Keyer Operation .....	52
2. Ground Connections .....	11	Tips for Successful CW Memory Keyer Operation .....	53
3. Electrical Shock Prevention .....	11	Split Frequency Operation .....	54
4. Antenna Precautions .....	11	TX CLARifier Operation .....	53
5. RF Field Exposure Advisory .....	12	Split VFO Operation .....	54
and Electromagnetic Compatibility .....	12	Quick Split Feature .....	54
<b>Accessory Installation</b> .....	13	Mode K Satellite Operation .....	55
1. Lineae Amplifier Interfacing .....	13	Digital Mode Operation .....	55
2. Digital Modem Interfacing (TNC, WeatherFax, etc.) ..	16	AFSK RTTY or Packet Operation .....	56
3. Other Digital/Recording Device Interfacing .....	17	FSK RTTY Operation .....	56
4. CW Key/Paddle and Computer Keying .....	18	AM Transmission .....	57
Interface Suggestions .....	18	Basic Operation .....	57
<b>Front Panel Controls, Switches, &amp; Jacks</b> .....	20	FM Operation .....	58
<b>Display Panel Indicators and Icons</b> .....	28	Simplex (Non-Repeater) Operation .....	58
<b>Rear Panel Connectors and Switches</b> .....	32	Repeater Operation .....	58
<b>Bottom Panel</b> .....	34	<b>Memory Operation</b> .....	59
<b>Operation</b> .....	35	QMB Channel Programming/Recall .....	59
Before You Start .....	35	Memory Operation on "Regular" Memory Channels ..	60
Receiving .....	35	(Channel #1-01 to 1-99) .....	60
Antenna Selection .....	35	Memory Operation on Split-Frequency Channels ..	62
Bandwidth Selection .....	37	(Channel #d-01 to d-10) .....	62
Amateur Band Selection .....	37	Memory Operation on "CALL" Channels .....	63
Direct Keypad Frequency Entry .....	38	(Channel #C-01 to C-11) .....	63
Stacked VFO System .....	38	Adding Alpha-Numeric Labels to Memory Channels ..	64
Frequency Navigation .....	38	Memory Mode Accessories .....	65
VFO Tuning Dial .....	39	Moving Memory Data to VFO-A .....	65
Shuttle Jog (VFO-A) .....	39	Deleting Data from a Memory Channel .....	65
Front Panel Up/Down Switches .....	39	<b>Scanning Operation</b> .....	66
MH-31B8 Hand MicUP/DWN/FST Switches .....	39	Scanning Operation .....	66
MD-100A8X Desk Microphone .....	39	Scan Skip Programming (Memory Mode Only) .....	66
Rotary Scanning Switch .....	39	Programmable Memory Scan (PMS) Operation .....	66
Lock Switches .....	39	Scan-Resume Choices .....	67
Operating Convenience Features .....	40	<b>Dual Watch Operation</b> .....	68
Display Brightness Control .....	40	<b>Menu Operation</b> .....	69
Keypad Beep Frequency/Level .....	40	Normal Menu Operation .....	69
Receiver Accessories .....	41	Panel Menu Operation .....	70
Clarifier (Offset Tuning) .....	41	Quick Menu Operation .....	70
CW Center Tuning (Enhanced Tuning Scale) ..	41	Menu Mode Selections and Settings .....	73
CW SPOT .....	41	<b>VHF/UHF Transverter Operation</b> .....	84
RF Preamplifier Selections .....	41	<b>Phone Pacth Operation</b> .....	85
AGC Selection .....	42	<b>CAT (Computer-Aided Transceiver) System Protocol</b> .....	86
Squelch .....	42	<b>CAT</b> Data Protocol .....	88
General Coverage Reception .....	42	Constructing Sending CAT Commands .....	88
Dealing with Interference .....	43	Downloading FT-920 Data .....	89
SHIFT Control .....	43	14-Byte Frequency Data Record Structure .....	90
HIGH CUT/LOW CUT Controls (DSP) .....	43	<b>Memory Backup</b> .....	91
NOTCH Filter (DSP) .....	44	<b>Microprocessor Resetting</b> .....	92
RF GAIN Control .....	44	<b>Installation of Optional Accessories</b> .....	93
IF Noise Blanker (NB) .....	44	Bottom Case Removal .....	93
DSP Noise Reduction (NR) .....	44	Installation of Optional Filters YF-116C/YF-116A .....	94
Tools for Strong-Signal .....	45	Installation of High-Stability Oscillator TCXO-7 .....	94
and Low-Frequency Operation .....	45	Installation of FM Unit FM-1 .....	94
IPO (Intercept Point Optimization) .....	45		
ATT (Front End Attenuator) .....	46		
Digital Voice Recorder Operation (DVR) .....	46		

# General Description

Congratulations on the purchase of your Yaesu FT-920! Whether this is your first rig, or if Yaesu equipment is already the backbone of your amateur radio station, it is our sincere hope that you will derive many years of operating enjoyment from your new transceiver.

The FT-920 is a state-of-the-art amateur transceiver incorporating a multitude of advanced features to give you the competitive edge in a wide variety of operating applications. The FT-920 offers up to 100 Watts of adjustable power output on all amateur bands between 160 meters and 6 meters (25 Watts carrier in the AM mode), utilizing rugged, low-distortion MOS FET final amplifier transistors. Operation in the SSB, CW, AM, AFSK, and FSK modes is built in, and an FM module is available as an option.

Yaesu's renowned Omni-Glow™ LCD display provides a wealth of information regarding transceiver status, and it includes enhanced tuning aids for many operating applications.

The built-in high-speed automatic antenna tuner may be utilized both on receive and transmit, providing improved impedance matching for the transmitter and protection from out-of-band signals on receive. A built-in Digital Voice Recorder allows storage and playback of incoming signals, and also allows you to store up to four repetitive messages (such as "CQ Contest. . .") of up to 16 seconds each. And the Electronic Memory Keyer also provides storage of CW messages, including incremented, imbedded contest numbers, to reduce operator fatigue in contests. Independent KEY jacks on the front and rear panels allow connection of keyer paddles to one jack and a computer or straight key to the other, for optimum contest work. A CW Pitch control and Spot tone provide efficiency in operating, and both full QSK and semi-break-in CW (VOX switching) are provided.

The receiver section is highlighted by the high-performance Digital Signal Processing filters, which provide razor-sharp selectivity, an automatic seeking Notch filter, and Noise Reduction. The high-intercept front end circuitry includes ten input bandpass filters with PIN diode switching, optimized RF preamplifiers for both high and low bands, and Intercept Point Optimization (IPO) for high-signal, high-noise environments. A separate receive-only antenna jack is provided, in addition to the two main TX/RX jacks, for connection of a Beverage or other low-noise receiving antenna.

Yaesu's exclusive Shuttle Jog tuning dial provides simple yet quick frequency excursions around the band. Independent tuning knobs for the two VFOs join direct keyboard frequency entry, one-touch band change, and extensive scanning capabilities to make the FT-920 a joy to use. And the FT-920's extensive memory system, sporting 99 regular memories, ten split-frequency memories, five QMB (Quick Memory Bank) channels, and an easy-access "CALL" channel for each band, provides the utmost in operating ease. Each of the memories (except the QMB channels) can be assigned an alpha-numeric label of up to seven characters, to aid in memory channel identification.

A host of convenience features is provided, including a Digital Speech Processor, SSB monitor circuit, all-mode Squelch, VOX, and a continuously-variable RF power control. Yaesu's CAT System for external computer control includes a built-in RS-232C level converter and DB-9 serial port on the rear panel, for easy connection to your home computer. And the extensive Menu system allow the owner to configure literally dozens of transceiver performance characteristics, such as voice audio response patterns, keyer weight, tuning steps, and power output to be applied to each antenna jack. The FT-920 clearly is the cost-performance leader in the Amateur Radio industry today!

Please take some time to familiarize yourself with the many features available in the FT-920, as described in the pages to follow. At Yaesu, we appreciate your investment in this fine transceiver, and we hope that you will take the time to read this manual thoroughly so as to get the most out of your new FT-920!

# Specifications

---

## General

<b>Receiving Frequency Range:</b>	100 kHz ~ 30 MHz, 48 ~ 56 MHz			
<b>Transmitting Frequency Range:</b>	160 ~ 6 Meter Amateur Bands			
<b>Operating Temperature Range:</b>	-10° ~ +50° C			
<b>Frequency Stability:</b>	±10 ppm; ±2 ppm w/TCXO-7			
<b>Frequency Accuracy:</b>	< ±7 ppm (FM within ± 500 Hz) w/TCXO-7: < ±3.5 ppm (FM within ± 460 Hz)			
<b>Emission Modes:</b>	USB/LSB, CW, AM, FM, FSK, AFSK			
<b>Frequency Steps:</b>	1 Hz/10 Hz/100 Hz for SSB/CW/FSK/AFSK 10 Hz/100 Hz/1000 Hz for AM/FM			
<b>Antenna Impedance:</b>	50 Ω, unbalanced			
<b>Antenna Tuner Matching Range:</b>	16.5 Ω ~ 150 Ω			
<b>Power Consumption:</b>	<b>Input</b>	<b>Rx (no signal)</b>	<b>Rx (Signal present)</b>	<b>Tx (100W)</b>
	13.5 VDC	2.0A	2.5A	22A
<b>Supply Voltage:</b>	13.5 VDC (±10%), negative ground			
<b>Dimensions:</b>	410(W) x 135(H) x 316(D) mm			

## Transmitter

<b>Power Output:</b>	160 m ~ 10 m amateur bands Adjustable up to 100 Watts (25 Watts AM carrier) 6 m amateur band Adjustable up to 100/10 Watts (25/2.5 Watts AM carrier)			
<b>Modulation Types:</b>	SSB: J3E Balanced, filtered carrier AM: A3E Low-level (early stage), (w/optional YF-116A AM Filter) FM: F3E Variable reactance PM FSK: J1D/J2D Audio-Frequency-Shifted Keying			
<b>Maximum FM Deviation:</b>	±2.5 kHz (narrow), ±5.0 kHz (wide)			
<b>FSK Shift Frequencies:</b>	170, 425, and 850 Hz			
<b>Packet Shift Frequency:</b>	200 Hz			
<b>Harmonic Radiation:</b>	At least 50 dB below peak output (HF) At least 60 dB below peak output (VHF)			
<b>SSB Carrier Suppression:</b>	At least 40 dB below peak output			
<b>Undesired Sideband Suppression:</b>	At least 50 dB below peak output			
<b>Audio Response (SSB, DSP Off):</b>	Not more than -6 dB from 400 to 2600 Hz			
<b>SSB 3rd-order IMD:</b>	-31 dB or better @ 100 Watts PEP (14 MHz)			
<b>Microphone Impedance:</b>	500 Ω ~ 600 Ω			



## Receiver

<b>Circuit Type:</b>	Double-conversion Superheterodyne (FM: Triple-conversion)			
<b>Intermediate Frequencies:</b>	68.985 MHz 8.215 MHz 455 kHz (FM)			
<b>Sensitivity:</b>	Frequency	SSB/CW/Dig.(2.4 kHz)	AM (6 kHz)	FM (28 MHz +)
	150 ~ 250 kHz	5 $\mu$ V	40 $\mu$ V	—
	250 ~ 500 kHz	4 $\mu$ V	32 $\mu$ V	—
	0.5 ~ 1.8 MHz	2 $\mu$ V	16 $\mu$ V	—
	1.8 ~ 24.5 MHz	0.20 $\mu$ V	2 $\mu$ V	0.5 $\mu$ V
	24.5 ~ 54 MHz	0.13 $\mu$ V	1.3 $\mu$ V	0.25 $\mu$ V
	(With Preamp On, for 10 dB S+N/N or 12 dB FM SINAD)			
<b>IF Selectivity (-6/-60 dB):</b>	SSB, CW, FSK, AFSK 2.4 kHz/5.0 kHz CW 500 Hz/1.8 kHz (w/optional YF-116C CW Filter) AM 6 kHz/14 kHz (w/optional YF-116A AM Filter) FM 12 kHz/25 kHz (w/optional FM-1 FM Unit)			
<b>Squelch Sensitivity (IPO Off):</b>	SSB/CW/Digital/AM: <2.0 $\mu$ V FM (28-56 MHz): <0.32 $\mu$ V			
<b>IF Rejection:</b>	>70 dB (HF) >50 dB (VHF)			
<b>Image Rejection:</b>	>70 dB (1.8 ~ 56 MHz)			
<b>IF Shift Range:</b>	$\pm$ 1.2 kHz			
<b>DSP Notch Depth:</b>	>35 dB			
<b>Audio Output:</b>	1.5 W into 4 $\Omega$ with <10% THD (Speaker) 100 mV @ 600 $\Omega$ (Digital, fixed level)			
<b>Audio Output Impedance (SPKR):</b>	4 $\Omega$ ~ 8 $\Omega$			

## Automatic Antenna Tuner

<b>Impedance Range:</b>	16.7 $\Omega$ ~ 150 $\Omega$ (1.8 ~ 30 MHz) 25.0 $\Omega$ ~ 100 $\Omega$ (50 ~ 54 MHz)
<b>Frequency Range:</b>	160 m ~ 6 m amateur bands
<b>Matching Time:</b>	<30 seconds
<b>Matched SWR:</b>	<1.4:1

Specifications are subject to change, in the interest of technical improvement, without notice or obligation. Specifications are guaranteed only within Amateur bands.

# Accessories & Options

## Supplied Accessories

<u>Item</u>	<u>Quantity</u>
MH-31 <sub>B8</sub> Hand Microphone .....	1
DC Cable fused for 25 Amps .....	1
Spare 25 Amp Fuse .....	1

## Available Options

MD-100 <sub>A8X</sub>	Desk-Top Microphone
FM-1	FM Unit
YF-116C	500 Hz CW Filter
YF-116A	6 kHz AM Filter
TCXO-7	High-Stability Reference Oscillator Unit (2 ppm)
FP-1025A	AC Power Supply, Switching Regulator Type (25A) (USA only)
FP-1030A	AC Power Supply, Linear Type (25A)
YH-77STA	Stereo Headphones
SP-8	External Speaker w/Audio Filters
FL-7000	500 Watt Solid State HF Linear Amplifier
VL-1000	1000 Watt Solid State HF+50 MHz Linear Amplifier
E-767	Band Data + T/R Switching Cable for FL-7000
RCA Connector	(P/N P0090544)
2 Pin Miniature Plug	(P/N P0090034)
3 Pin Phone Plug	(P/N P0090008)
5 Pin DIN Plug	(P/N P0091006)

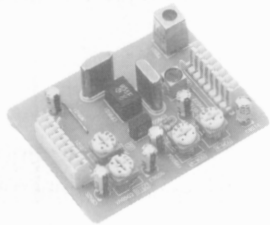

FM-1



MD-100<sub>A8X</sub>



YH-77STA

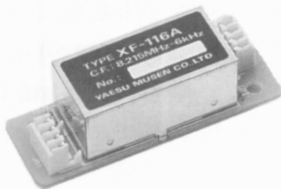

YF-116A

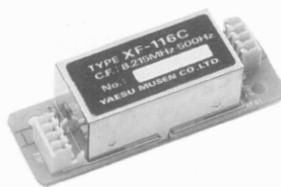

YF-116C

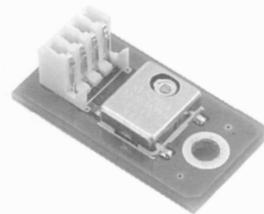

TCXO-7



FP-1030A



SP-8



FL-7000

<p style="text-align: center;"><b>MIC</b></p> <ul style="list-style-type: none"> <li>① UP</li> <li>② +5V</li> <li>③ DOWN</li> <li>④ FAST</li> <li>⑤ GND</li> <li>⑥ PTT</li> <li>⑦ MIC GND</li> <li>⑧ MIC</li> </ul> <p style="text-align: right;"><i>as viewed from front panel</i></p>	<p style="text-align: center;"><b>DC 13.5V</b></p> <p style="text-align: right;"><i>as viewed from rear panel</i></p>						
<p style="text-align: center;"><b>BAND DATA</b></p> <ul style="list-style-type: none"> <li>① +13V</li> <li>② TX GND</li> <li>③ GND</li> <li>④ BAND DATA A</li> <li>⑤ BAND DATA B</li> <li>⑥ BAND DATA C</li> <li>⑦ BAND DATA D</li> <li>⑧ LINEAR</li> </ul> <p style="text-align: right;"><i>as viewed from rear panel</i></p>	<p style="text-align: center;"><b>CAT</b></p> <ul style="list-style-type: none"> <li>① N/A</li> <li>② SERIAL OUT</li> <li>③ SERIAL IN</li> <li>④ N/A</li> <li>⑤ GND</li> <li>⑥ N/A</li> <li>⑦ N/A</li> <li>⑧ N/A</li> <li>⑨ NC</li> </ul> <p style="text-align: right;"><i>as viewed from rear panel</i></p>						
<p style="text-align: center;"><b>DATA</b></p> <p style="text-align: right;"><i>as viewed from rear panel</i></p> <p style="text-align: center;"><b>AFSK-FSK SWITCH</b></p> <table style="width: 100%; border: none;"> <tr> <td style="width: 50%; vertical-align: top;"> <p style="text-align: center;"><b>AFSK</b></p> <ul style="list-style-type: none"> <li>① DATA IN</li> <li>② GND</li> <li>③ PTT</li> <li>④ DATA OUT</li> <li>⑤ BUSY</li> </ul> </td> <td style="width: 50%; vertical-align: top;"> <p style="text-align: center;"><b>FSK</b></p> <ul style="list-style-type: none"> <li>① SHIFT</li> <li>② GND</li> <li>③ PTT</li> <li>④ DATA OUT</li> <li>⑤ BUSY</li> </ul> </td> </tr> </table>	<p style="text-align: center;"><b>AFSK</b></p> <ul style="list-style-type: none"> <li>① DATA IN</li> <li>② GND</li> <li>③ PTT</li> <li>④ DATA OUT</li> <li>⑤ BUSY</li> </ul>	<p style="text-align: center;"><b>FSK</b></p> <ul style="list-style-type: none"> <li>① SHIFT</li> <li>② GND</li> <li>③ PTT</li> <li>④ DATA OUT</li> <li>⑤ BUSY</li> </ul>	<p style="text-align: center;"><b>PHONES</b></p> <table border="1" style="width: 100%; border-collapse: collapse;"> <tr> <td style="text-align: center;"><b>EXT SPKR</b></td> <td style="text-align: center;"><b>RCA PLUG</b></td> </tr> <tr> <td style="text-align: center;"> </td> <td style="text-align: center;"> </td> </tr> </table>	<b>EXT SPKR</b>	<b>RCA PLUG</b>		
<p style="text-align: center;"><b>AFSK</b></p> <ul style="list-style-type: none"> <li>① DATA IN</li> <li>② GND</li> <li>③ PTT</li> <li>④ DATA OUT</li> <li>⑤ BUSY</li> </ul>	<p style="text-align: center;"><b>FSK</b></p> <ul style="list-style-type: none"> <li>① SHIFT</li> <li>② GND</li> <li>③ PTT</li> <li>④ DATA OUT</li> <li>⑤ BUSY</li> </ul>						
<b>EXT SPKR</b>	<b>RCA PLUG</b>						
<b>KEY</b>							
<p style="text-align: center;"><b>FRONT</b></p> <p>KEYER SWITCH: "ON"</p> <p>KEYER SWITCH: "OFF"</p>	<p style="text-align: center;"><b>REAR</b></p> <p>KEYER SWITCH: "ON" PDL-KEY SWITCH: "PDL"</p> <p>KEYER SWITCH: "OFF" PDL-KEY SWITCH: "PDL"</p> <p>KEYER SWITCH: "ON" PDL-KEY SWITCH: "KEY"</p> <p>KEYER SWITCH: "OFF" PDL-KEY SWITCH: "KEY"</p>						

# Installation

## Preliminary Inspection

Inspect the transceiver upon opening the packing carton. Check that all controls and switches work freely, and inspect the cabinet for any cosmetic damage. Ensure that the accessory cable and fuses are included.

If any damage is found, document it completely, and contact the shipping company (or Dealer, if you purchased it over-the-counter) right away. Save the packing materials in case you need to return the set for service.

## DC Power Connections

The FT-920 Transceiver is designed for operation from 13.5 Volts DC, negative ground, with the DC source being capable of providing 20 Amperes of continuous current. For base station installations, we recommend the matching Yaesu FP-1030A AC power supply, which was specifically designed for compatibility with your FT-920. You can, of course, use another DC source, so long as it is well regulated and meets the above voltage/current specifications. In any case, be extremely careful to avoid reversed polarity connections when installing your FT-920. See the *Caution* box below.

If you are connecting the FP-1030A to the FT-920, before connecting power, check the label on the rear of the power supply which indicates the AC line voltage range for which the power supply is currently set. If your AC line voltage is outside this range, the input voltage range will need to be re-configured. If you have any questions about the voltage setting for your power supply, consult with your dealer before proceeding, as improper connections could cause serious damage not covered by your warranty. See the documentation accompanying your power supply for details on the exact procedure required for power supply AC voltage re-configuration.

Connection of the DC line must be made according to the instructions below:

**The RED DC power lead connects to the Positive (+) DC terminal; and The BLACK DC power lead connects to the Negative (-) DC terminal.**

Make sure the FT-920's POWER switch is off, and plug the DC cable into the 6-pin Molex jack on the rear panel of the transceiver.

### Caution

Serious damage can result if improper supply voltage is applied to this transceiver. Your Limited Warranty does not cover damage caused by the application of AC, reversed polarity DC, or DC outside the specified range of 13.5 V  $\pm$ 10%.

If you wish to use a power supply other than one of Yaesu manufacture, you must make certain that any DC supply connector to the transceiver matches the FT-920 requirements. See the DC connector pinout on the previous page. **Other manufacturers have power supplies with a physically matched connector that is wired differently; this may cause serious damage to the FT-920.**

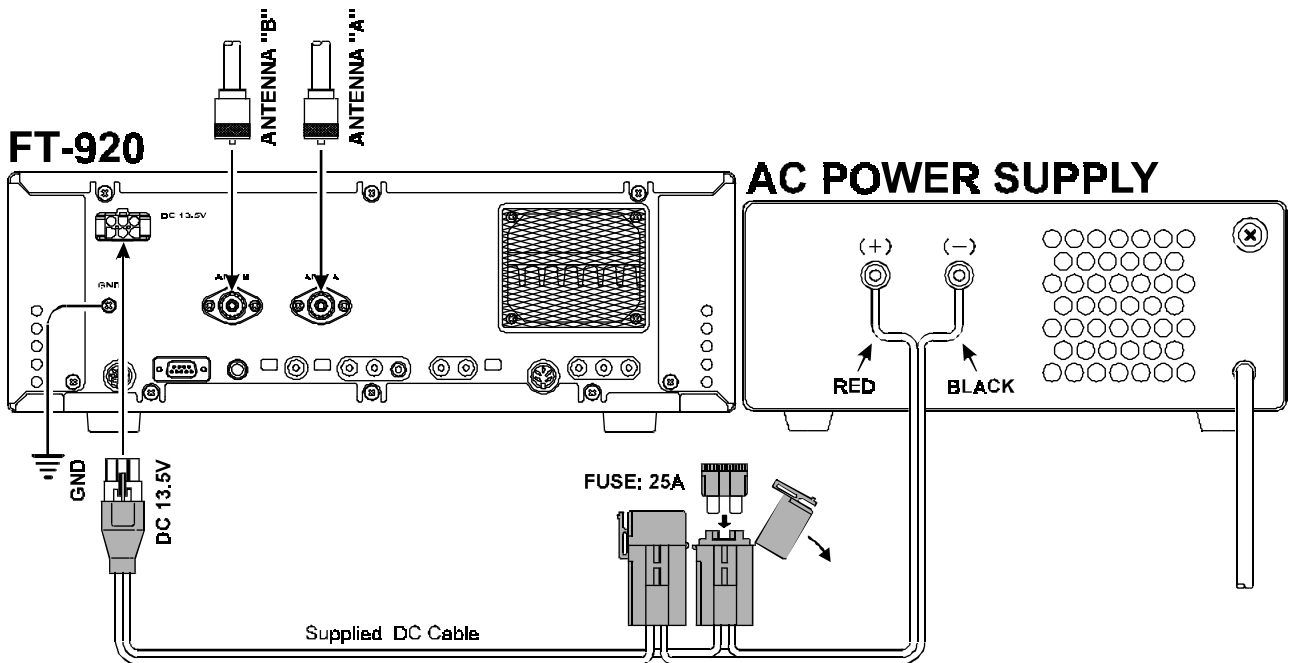
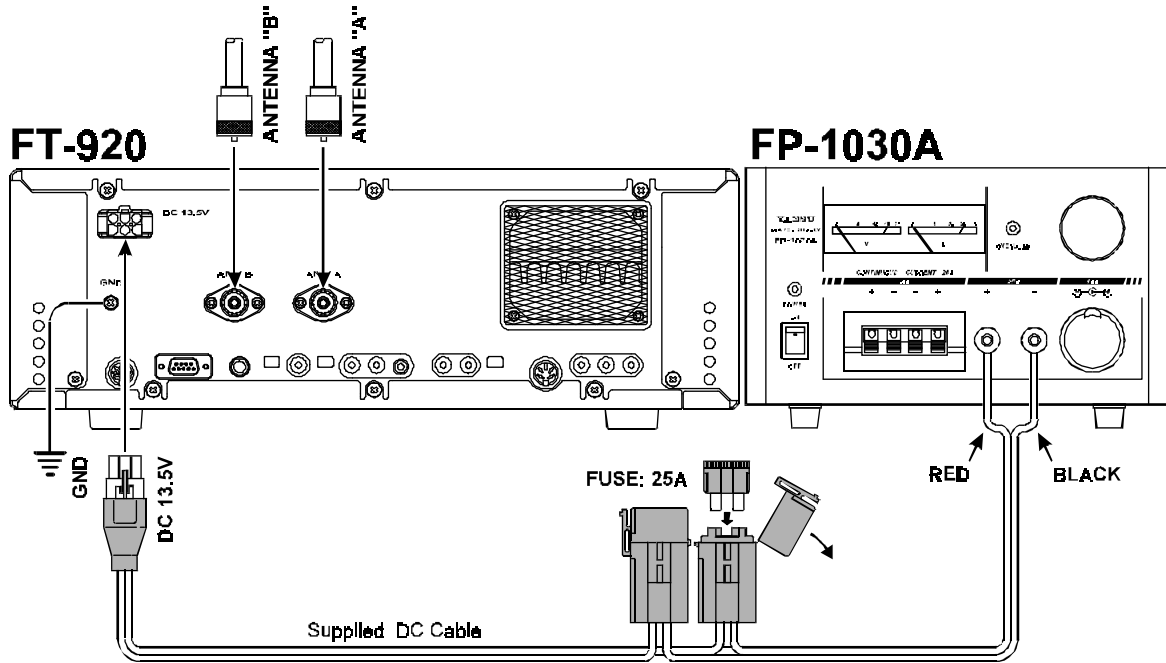

# Installation

## Transceiver Location

To ensure long life of the transceiver's components, be certain to provide adequate ventilation around the cabinet of the FT-920. The cooling system of the transceiver must be free to draw cool air in from the side of the transceiver and expel warm air from the rear exhaust port.

Do not install this transceiver on top of another heat-generating device (such as a linear amplifier), and do not place equipment, books, or papers on top of the transceiver. Place the radio on a hard, flat, stable surface. Avoid heating vents and window locations that could expose the transceiver to excessive direct sunlight, especially in hot climates.

## Grounding

The FT-920 HF transceiver, like any other HF communications apparatus, requires an effective ground system for maximum electrical safety and best communications effectiveness. A good ground system can contribute to station efficiency in a number of ways:

- ❑ It can minimize the possibility of electrical shock to the operator.
- ❑ It can minimize RF currents flowing on the shield of the coaxial cable and the chassis of the transceiver; such currents may lead to radiation which can cause interference to home entertainment devices or laboratory test equipment.
- ❑ It can minimize the possibility of erratic transceiver/accessory operation caused by RF feedback and/or improper current flow through logic devices.

An effective earth ground system make take several forms; for a more complete discussion, see an appropriate RF engineering text. The information below is intended only as a guideline.

Typically, the ground connection consists of one or more copper-clad steel rods, driven into the ground. If multiple ground rods are used, they should be positioned in a "V" configuration, and bonded together at the apex of the "V" which is nearest the station location. Use a heavy, braided cable (such as the discarded shield from type RG-213 coaxial cable) and strong cable clamps to secure the braided cable(s) to the ground rods. Be sure to weatherproof the con-

nections to ensure many years of reliable service. Use the same type of heavy, braided cable for the connections to the station ground bus (described below).

Inside the station, a common ground bus consisting of a copper pipe of at least 25 mm (1") diameter should be used. An alternative station ground bus may consist of a wide copper plate (single-sided circuit board material is ideal) secured to the bottom of the operating desk. Grounding connections from individual devices such as transceivers, power supplies, and data communications devices (TNCs, etc.) should be made directly to the ground bus using a heavy, braided cable.

Please note that some types of external power supplies (not of Yaesu manufacture), while otherwise being suitable for use with the FT-920, may be designed such that the Negative (black) DC output terminal is "floating" (not connected directly to ground). This may cause erratic operation, especially when transmitting, due to the potential for ground loops to form between your antenna system, your station ground, and your power supply. This potential susceptibility is not unique to the FT-920, and the problem can usually be solved by directly grounding the Negative DC terminal to the power supply chassis, which can then be bonded to earth ground; check first with the power supply manufacturer, though, to be certain that this grounding technique is acceptable to them.

Do not make ground connections from one electrical device to another, and thence to the ground bus. This so-called "Daisy-Chain" grounding technique may nullify any attempt at effective radio frequency grounding.

Inspect the ground system — inside the station as well as outside — on a regular basis so as to ensure maximum performance and safety.

## Antenna Considerations

The FT-920 is designed for use with any antenna system providing a 50  $\Omega$  resistive impedance at the desired operating frequency. While minor excursions from the 50  $\Omega$  specification are of no consequence, the transceiver's Automatic Antenna Tuner may not be able to reduce the impedance mismatch to an acceptable value if the Standing Wave Ratio (SWR) present at the Antenna jack is greater than 3:1. Among the undesirable consequences that high SWR may produce are:

- ❑ The transceiver's power amplifier protection circuitry will reduce power if the Automatic Antenna Tuner is unsuccessful in reducing the SWR.
- ❑ Even if the Automatic Antenna Tuner successfully normalizes the impedance presented to the radio, feedline losses will escalate rapidly with high SWR at the higher operating frequencies, especially 28 MHz and 50 MHz.
- ❑ Although high SWR itself does not cause feedline radiation, the sudden onset of high SWR may well indicate a mechanical failure in a matching device, leading to an electrical condition which *may* cause excessive feedline radiation, which can cause interference to nearby home-entertainment devices.

Every effort should, therefore, be made to ensure that the impedance of the antenna system utilized with the FT-920 be as close as possible to the specified 50  $\Omega$  value.

Any antenna to be used with the FT-920 must, ultimately, be fed with 50  $\Omega$  coaxial cable. Therefore, when using a "balanced" antenna such as a dipole, remember that a balun or other matching/balancing device must be used so as to ensure proper antenna performance.

Use high-quality 50  $\Omega$  coaxial cable for the lead-in to your FT-920 transceiver. All efforts at providing an efficient antenna system will be wasted if poor quality, lossy coaxial cable is used. Losses in coaxial lines increase as the frequency increases, so a coaxial line with only 0.5 dB of loss at 7 MHz may have 2 dB of loss at 28 MHz. For reference, the chart below shows approximate loss figures for typically-available coaxial cables frequently used in amateur radio installations.

## Memory Backup

The lithium memory **BACKUP** switch on the rear panel is turned on at the factory, allowing VFO, memory, and menu data to be retained while power is off. Backup current is minuscule, so it is not necessary to turn the **BACKUP** switch off unless the transceiver is to be stored for an extended period.

After five or more years of operation, the transceiver may fail to retain memories. At this point, the lithium battery should be replaced. Contact your dealer for procurement of the battery, and follow the instructions on page 91 for replacement of the battery.

*Before completing installation of your FT-920 transceiver, please take the time to review the following safety guidelines.*

### Loss in dB per 30m (100 feet) for Selected 50 $\Omega$ Coaxial Cables

(Assumes 50  $\Omega$  Input/Output Terminations)

Cable Type	Loss: 2 MHz	Loss: 15 MHz	Loss: 28 MHz
RG-58A	0.55	1.75	2.60
RG-58 Foam	0.54	1.50	2.00
RG-8X	0.39	1.07	1.85
RG-8A, RG-213	0.27	0.85	1.25
RG-8 Foam	0.22	0.65	0.88
Belden® 9913	0.18	0.50	0.69
RG-17A	0.08	0.30	0.46

Loss figures are approximate; consult cable manufacturers' catalogs for complete specifications.

Loss figures can increase significantly if high SWR is present on the transmission line.

# Installation

## Adjusting the Front Feet

The two front feet of the FT-920 can be set in either of two positions. By turning the knurled ring around a (retracted) foot clockwise, the middle of the foot will extend about one centimeter. Turn the ring as far as it will go (about  $\frac{1}{4}$  turn) to lock the extended foot in place. To retract an extended foot, turn the knurled ring counter-clockwise  $\frac{1}{4}$  turn while pressing on the center of the foot.

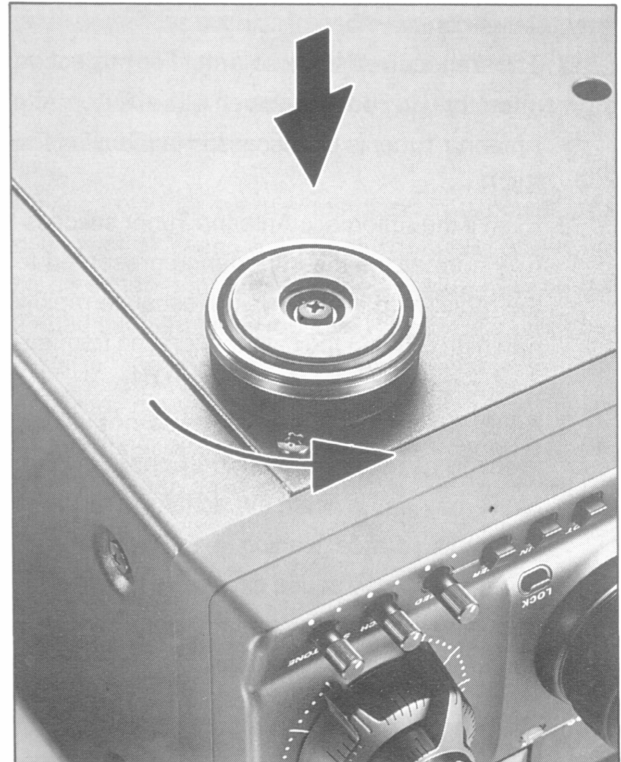
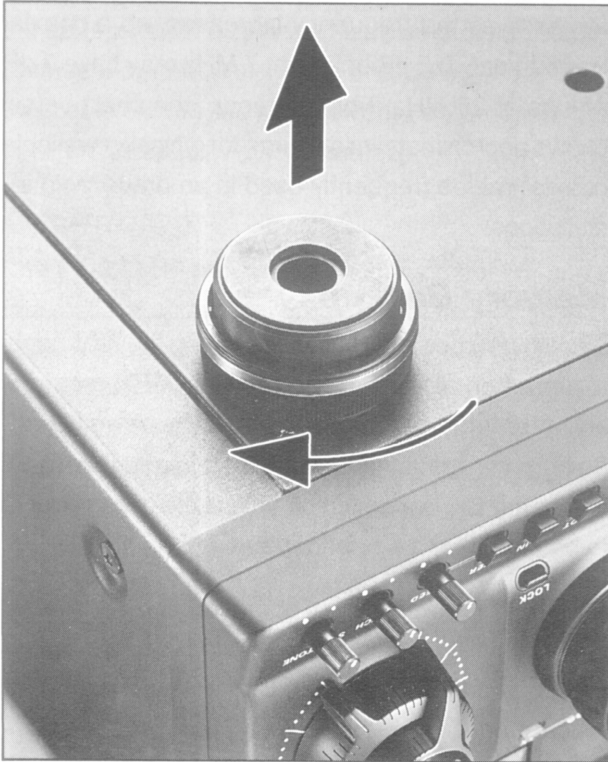



## 1. Power Connections

Be certain to follow the guidelines on page 6 carefully so as to ensure that your AC power supply is configured for the AC line voltage used in your area.

When making DC connections, be absolutely certain to observe proper polarity in your wiring. Note that other manufacturers may use the same type of DC power connector as does Yaesu, but the wiring configuration of the other manufacturer's plug may be different from that specified for your transceiver. Accordingly, you should verify the pin configuration of the plug before attempting to use a non-Yaesu DC cable of any kind.

## 2. Ground Connections

Besides following the guidelines presented on page 8 carefully, note that household or industrial gas lines must **never** be used in an attempt to establish an electrical ground. Cold water pipes may, in some instances, help in the grounding effort, but gas lines represent a significant explosion hazard, and should never be used.

## 3. Electrical Shock Prevention

Be certain that all station wiring is properly insulated so as to prevent short-circuits which could damage this transceiver and/or accessories connected to it. Be sure to protect power cables from damage due to abrasion by ensuring that they cannot be walked upon nor crushed under rolling chairs, etc. Never route power cables near sharp metallic edges which might cut through protective insulation.

Never spill liquids into this transceiver, and do not drop sharp metallic objects into the transceiver enclosure. Electrical shock may result when you attempt to remove the object.

Unsupervised children should be kept away from any electrical apparatus such as the FT-920 transceiver and its accessories.

## 4. Antenna Precautions

Always install antennas such that they can **never** come in contact with outdoor power lines in the event of a catastrophic antenna support or power line support structure failure. An adequate safety margin is *usually* provided by separating power lines from the antenna and its support structure [1.5 times the height of the support] *plus* [the length of any antenna or guy wires attached to the support] *plus* [the height of the power line support pole].

Ground the antenna support structure adequately, so as to dissipate energy absorbed during a lightning strike. Install appropriate lightning arrestors in the antenna lead-in and rotator cable (if used) according to the arrestor's instructions.

In the event of an approaching electrical storm, disconnect all antenna lead-in, rotator control, and power cables *completely* from the station, **but only if the storm is not immediately in your area**. Do not allow disconnected cables to touch the case of your FT-920 transceiver or accessories, as lightning can easily jump from the cable to the circuitry of your transceiver via the case, causing irreparable damage. If a lightning storm *is* in progress in your immediate area, *do not* attempt to disconnect the cables, as you could be killed instantly should lightning strike your antenna structure or a nearby power line.

If a vertical antenna is used, be certain that humans and/or pets or farm animals are kept away both from the radiating element (to prevent electrical shock and RF exposure danger) *and* the ground system (in the event of an electrical storm). The buried radials of a ground-mounted vertical antenna can carry lethal voltages outward from the center of the antenna in the event of a direct lightning strike.

# Safety Precautions

---

## 5. RF Field Exposure Advisory and Electromagnetic Compatibility

This transceiver is capable of power output in excess of 50 Watts, so customers in the United States may be required to demonstrate compliance with Federal Communications Commission (FCC) regulations concerning maximum permissible exposure to radio frequency energy. Compliance is based on the actual power output used, feedline loss, antenna type and height, and other factors which can only be evaluated as a system. Information regarding these regulations may be available from your Dealer, your local radio club, from the FCC directly (press releases and other information can be found on the FCC's site on the World Wide Web at < <http://www.fcc.gov> >), or from the American Radio Relay League, Inc. (225 Main St., Newington CT 06111 or < <http://www.arrl.org>>).

Remember to re-evaluate your station's compliance with these regulations during portable operations such as Field Day or special-event stations. Note, also, that power output may be programmed to 50 Watts (maximum) via Menu Items U-49 and U-50; see page 79 for details.

Regarding electromagnetic compatibility: if this transceiver is used with, or in the vicinity of, a computer or computer-driven accessories, you may need to experiment with grounding and/or Radio Frequency Interference (RFI) suppression devices (such as ferrite cores) to minimize interference to *your* communications caused by energy from the computer. Computer-generated RFI is usually a result of inadequate shielding of the computer's cabinet or I/O and peripheral connections. While computer equipment may "comply" with RF emission standards, this does *not* ensure that sensitive amateur radio receivers will not experience interference from the device!

Be certain to use only shielded cables for TNC-to-Transceiver connections. You may need to install AC line filters on the power cord(s) of the suspected equipment, and decoupling ferrite toroidal chokes may be required on interconnecting patch/data cables. As a last resort, you can try installing additional shielding within the computer's case, using appropriate conductive mesh or conductive shielding tape. Especially check "RF holes" where plastic is used for cabinet front panels.

For further information, consult amateur radio reference guides and publications relating to RFI suppression techniques.

## 1. Linear Amplifier Interfacing

The FT-920 can be used with the (optional) Yaesu FL-7000 Linear Amplifier, which provides automatic band switching through the use of digital data sent via the **BAND** jack on the rear panel of the transceiver. Most other commonly-used linear amplifiers may also be used with the FT-920, so long as the Tx/Rx switching voltages and timing (sequencing) for the amplifier's control relay(s) are not extraordinary.

### Tx/Rx Control Devices for Linear Amplifier Switching

Two control devices are provided in the FT-920 for Tx/Rx control of an linear amplifier's relay(s).

- ① An open-collector transistor switch provides a solid-state, fast-acting closure to ground for low-voltage/low-current situations; maximum ratings are +50 V DC at 500 mA (maximum dissipation of 25W), and relays using negative DC voltages or AC of any kind must not be used with the transistor switch.

The transistor switch's "hot" lead is identified as **Tx GND** (since it closes to "GND" on "TX"), and is provided on Pin 2 of the **BAND** (DIN) connector on the rear panel of the FT-920. It is also provided via the rear-panel **Tx GND** jack when the **TR-RY** switch is set to the **TR** position.

- ② A mechanical relay is provided for high voltage/high-current applications, although the relay will not be fast enough for QSK (full break-in) CW operation; maximum ratings for the relay contacts are 220 V DC (maximum) at 270 mA, 30V DC at 2 A, or 125 V AC (maximum AC voltage) at 500 mA (60 Watts total maximum dissipation).

The relay's contacts may be accessed by connecting a shielded cable to the rear-panel **Tx GND** jack.

If the relay is being used, the **TR-RY** switch adjacent to the **Tx GND** RCA jack must be set to the **RY** position; conversely, if you are using the transistor switch, leave the **TR-RY** switch in the **TR** position, so as to eliminate the clicking of the relay.

The relay provides a mechanical closure to Ground on Transmit, while the (NPN) transistor switch sinks its (open) collector to Ground on Transmit. Check with the *manufacturer* of your amplifier (or other device) to confirm the amplifier switching voltage and current, if they are not clearly stipulated in the documentation for your equipment.

- ☑ Be absolutely certain to check the position of the **TR-RY** switch prior to connecting any external device to the **Tx GND** jack. Never connect an AC voltage, or a negative DC voltage, to the **Tx GND** jack if the **TR-RY** switch is set to **TR**. The Limited Warranty on this product does not cover damage caused by improper connections (excessive or improper voltage) to the rear panel jacks of the FT-920.

### About ALC

The FT-920 provides an external ALC jack on the rear panel (RCA-type jack) for input of **A**utomatic **L**evel **C**ontrol voltage from a linear amplifier.

ALC voltage is used to provide dynamic control of the output of the transceiver, so as not to provide more drive than is needed for full amplifier output. The ALC control voltage range is 0 to -4 V DC, with the voltage going more negative as the amplifier's drive requirements are approaching fulfillment.

The FT-920's ALC system is very typical of designs in the amateur radio industry, and consequently is compatible with many manufactured and home-built amplifiers. However, ALC voltage may be generated by an amplifier in a manner incompatible with efficient ALC operation in the FT-920, and it is important that you recognize the differences in amplifier ALC circuits before proceeding with ALC line connection.

- ☐ ALC circuits which detect **Power Output** from the amplifier, and generate negative-going ALC control voltage when maximum output power has been realized, will generally work properly with the FT-920. The exact amount of ALC voltage fed to the FT-920 can usually be adjusted via a potentiometer on the rear panel of the amplifier.
- ☐ ALC circuits which detect **Amplifier Tube Grid Current**, and generate ALC voltage when excessive grid current is present, may not work well with the FT-920 and other similar trans-

# Accessory Installation

ceivers, as the ALC voltage may be generated because of amplifier mis-tuning not related to an excessive-drive condition. With amplifiers deriving their ALC voltage in this manner, we recommend that you *not* connect the ALC line, and rather let the amplifier's protection circuitry manage its ALC requirements internally.

One useful alternative to ALC interconnection may be considered: by entering Menu Item(s) U-49 and/or U-50, you may define the maximum power output for the FT-920. So if your amplifier never requires more than 50 Watts of drive, just set the maximum power output to "50" via the menu system, and you will not have to worry about over-driving your amplifier. And since the power output may be set independently for each antenna port (use Menu Item U-49 for Antenna A, and U-50 for Antenna B), you may lower the power output on a port connected to your amplifier while retaining the full 100 Watts on the other antenna port.

## Interconnection with QSK Amplifiers

If using a Yaesu FL-7000 amplifier, connect the (optional) cable CT-11 from the transceiver **BAND** jack to the amplifier's **ACC-2** jack. This provides automatic band selection for the linear, as well as QSK Tx/Rx switching control and sequencing. Also connect an RCA-to-RCA patch cord (Yaesu Part #T9101296 -

supplied with the FL-7000) from the amplifier's **ALC** jack to the transceiver's **Ext ALC** jack, and connect an RF coaxial jumper (Yaesu Part #T9100980 - also supplied with the FL-7000) from the transceiver's antenna jack (**A** or **B**) to the amplifier's **RF INPUT** jack.

If using another manufacturer's QSK amplifier, and if it meets the 15 VDC/100 mA limitation for transistor switching described previously, connect the Tx/Rx switching line for the linear to Pin 2 of the **BAND** jack, and use Pin 3 for the shield of the cable. If the amplifier provides a closure to ground to confirm that its relays are properly seated, this "exciter-enable" line may be connected to Pin 8 of the **BAND** jack.

The **BAND** jack is a specialized, interlocked 8-pin DIN connector. When a suitable plug (Yaesu Part #P0090160) is inserted into the **BAND** jack, it opens the interlock which, in the case of the FT-920, grounds Pin 8. If no exciter-enable line is provided by your amplifier, connect a jumper between Pin 8 and Pin 3 (Ground); if you do not, the FT-920 will not allow itself to transmit.

If your QSK amplifier requires the exciter's control circuits to switch more than 100 mA, or uses more than 15 VDC for Tx/Rx relay switching, you will have to provide a suitable external interface transistor, controlled by Pin 2 of the **BAND** jack.

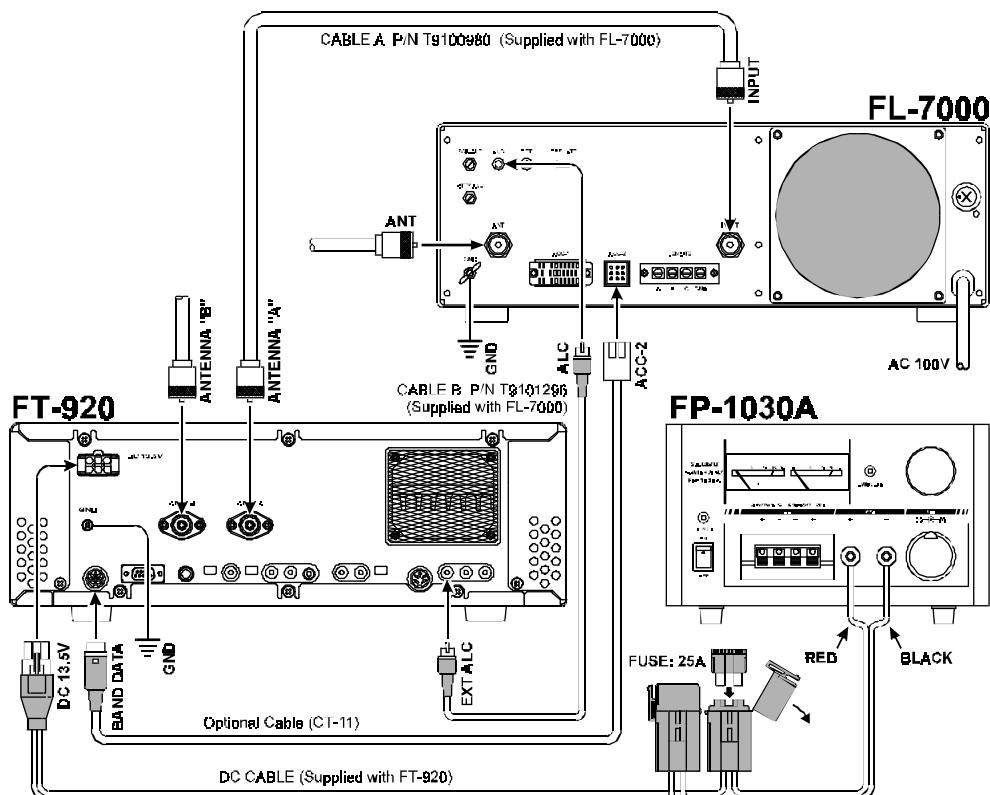

# Accessory Installation

## Interconnection with non-QSK Amplifiers (Yaesu FL-2100 Series or others)

The Tx GND jack on the rear panel of the transceiver provides for Tx/Rx switching of non-QSK amplifiers. A schematic diagram of the FT-920's internal relay circuit is shown below.

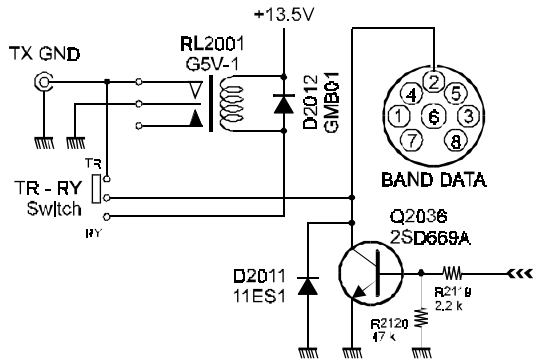

As the FT-920 is supplied from the factory, the internal relay is disabled, and a high-dissipation NPN transistor's (open) collector is connected to the Tx GND jack. To enable the relay for use with amplifiers requiring it, move the rear panel TR-RY switch, located in the hole near the center of the rear panel, to the RY position. Use a thin, insulated object like a toothpick to move the switch. Then connect the cen-

ter contact of the Tx GND RCA jack to the amplifier's relay control line, using the outer contact of the Tx GND jack for the shield. Connect the RF coaxial cable and, if compatible, the ALC cable as described in the QSK amplifier interconnection section above. Refer to the drawing below for details.

With the relay enabled, the FT-920 can support *non-QSK* linear Tx/Rx switching voltages of up to 220 VDC (maximum permissible DC voltage) at 270 mA, 30 VDC at 2 A, or 125 VAC (maximum permissible AC voltage) at 500 mA.

### Caution!

Do not exceed the maximum ratings of the switching circuitry (transistor or relay) of the FT-920 made available via the **BAND** or **Tx GND** jacks. Your warranty does not cover damage caused by improper interconnections to linear amplifiers. When in doubt, it is always safest to utilize the **Tx GND** jack with the TR-RY switch set to **TR**, as this configuration should handle the switching requirements of most all commonly-available amplifiers.

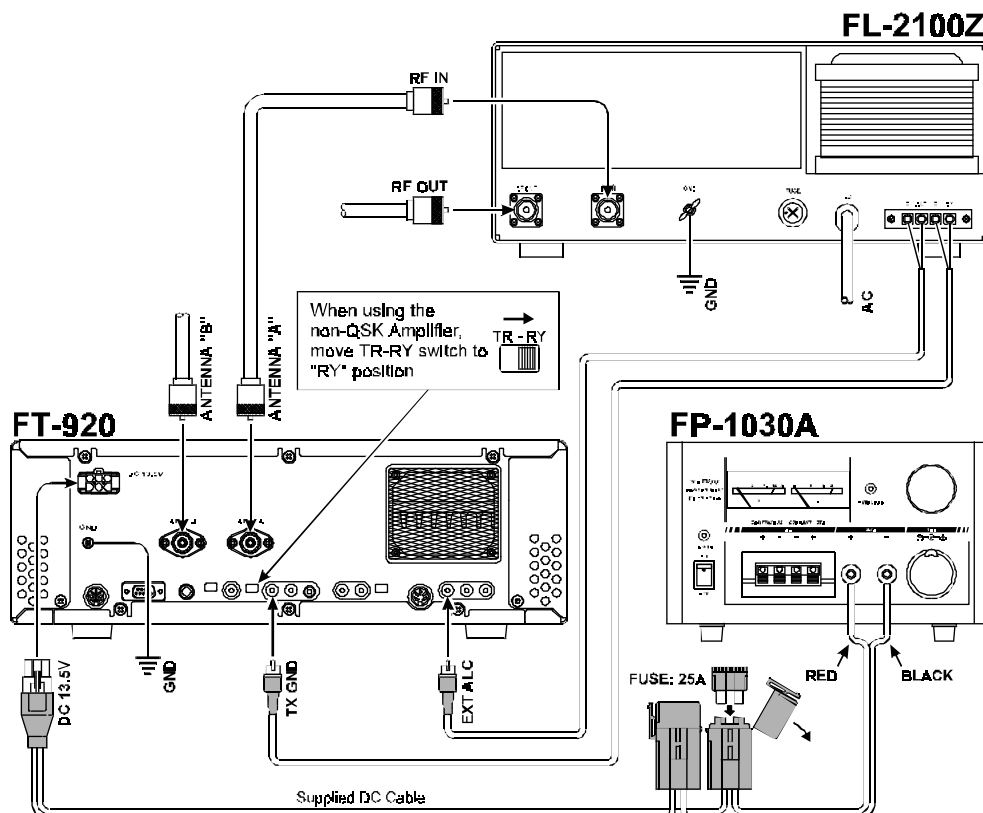

# Accessory Installation

## 2. Digital Modem Interfacing (TNC, WeatherFax, etc.)

The FT-920 provides several convenient interconnection points, as well as dedicated operating modes, for digital operation. While interfacing to commonly-available modems is simple and straightforward, it is important that you read the instructions below so as to understand the facilities that are provided on the FT-920.

### DATA Jack

This five-pin DIN connector is the primary interface port for most digital-mode operation. It provides the following connection points which may be required in your installation:

#### Pin 1 (AFSK Input):

Connect this pin to your TNC's "AFSK Out" or "Mic Audio" output line. The optimum input level is 30 mV rms, and the input impedance is 3 k $\Omega$ . Your TNC's audio output level potentiometer will allow you to set the level to the optimum value. This pin may be used either for 300 baud SSB-mode digital operation or for 1200-baud FM packet. The bandwidth and frequency response are not, however, suitable for 9600 baud operation. Be sure the **AFSK-FSK** switch on the rear panel is in the **AFSK** position.

For FSK operation (whereby the TNC closes a line to ground to accomplish teletype keying), set the **AFSK-FSK** switch to **FSK**, and connect your TNC's FSK keying line to Pin 1.

#### Pin 2 (Ground):

Connect this to the shield(s) of the cable(s) used for connections between the TNC and the FT-920.

#### Pin 3 (PTT):

Connect this pin to the PTT line from the TNC. This pin, when grounded by the TNC, places the FT-920 into the Transmit condition.

#### Pin 4 (Audio Out):

Connect this pin to your TNC's "RX Audio" input line. This is a constant-level (100 mV rms @ 600  $\Omega$ ) audio output line which is *not* affected by the position of the front-panel **AF GAIN** control.

#### Pin 5 (BUSY):

This is a "Squelch Status" pin not generally required for digital mode operation. This pin is held at +5V when the squelch is open, and is grounded when the receiver is muted by the squelch ("no-signal" condition).

### KEY Jack (Rear Panel)

If you wish to send CW using your TNC and computer keyboard, the CW Key output line from your TNC may be connected to the rear-panel **KEY** jack, according to the connection information provided on page 5.

Since a TNC's keying output is electrically similar to that of a Straight Key, set the rear panel's **PdL-KEY** switch to the **PdL** (Manual Key) position, and connect the TNC's key line there. You can still connect your keyer paddle to the *front panel* **KEY** jack, and use the FT-920's built-in electronic keyer, for those situations where you wish to send using the paddle; there is no need to switch the internal keyer on and off.

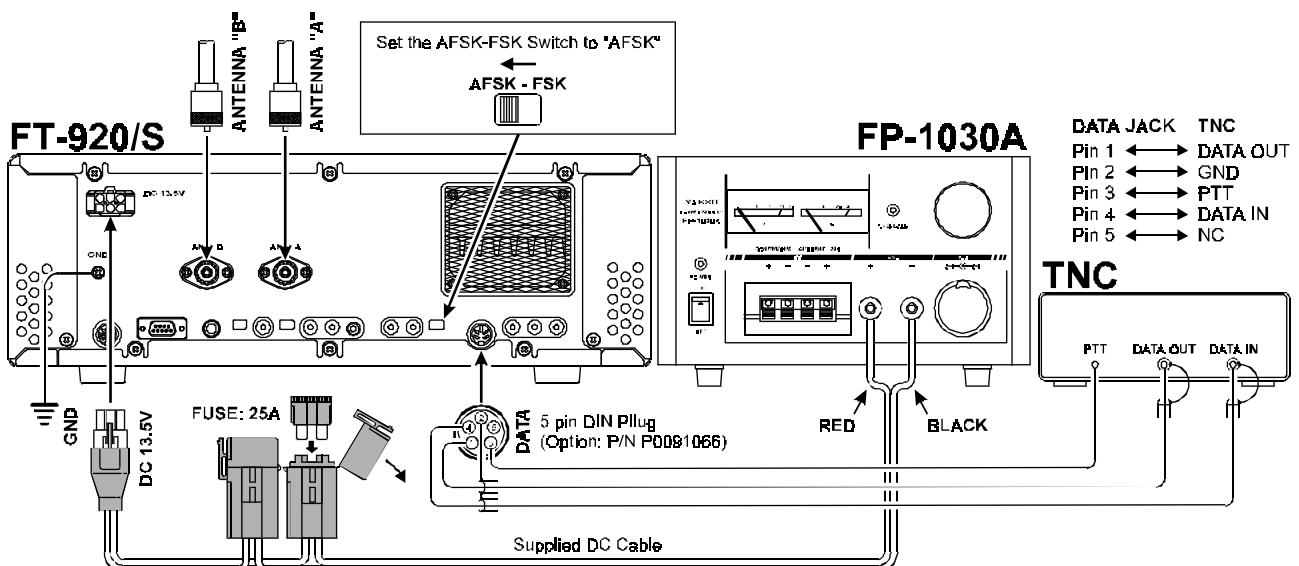

## 3. Other Digital/Recording Device Interfacing

### AF Out Jack

This is a 3.5 mm miniature phone jack which provides constant-level (100 mV @ 600 Ω) for connection to a WeatherFax decoder, tape recorder, or other accessory. The audio output level is not affected by the setting of the front panel **AF GAIN** control, so you can turn the volume down, if you like, without affecting the audio level being presented to your decoding device.

The connection to the **AF Out** jack is at the same level as the connection to Pin 4 of the **DATA** jack. However, the two output ports use independent output buffer amplifiers, so you can freely connect and disconnect devices to/from these ports without concern over the impedances and levels.

### PTT Jack

This RCA jack is wired in parallel with the **DATA** jack's Pin 3, and may be used in conjunction with a computer or TNC's PTT line, if desired.

### PATCH Jack

For transmit audio input for SSTV (Slow-Scan Television) operation, you may connect the SSTV terminal's Tx Audio line to the **PATCH** jack. You will need to disconnect the microphone, however, during transmission, as the **PATCH** jack is connected in a "Y" configuration along with the microphone input (from pin 8 of the **Mic** jack).

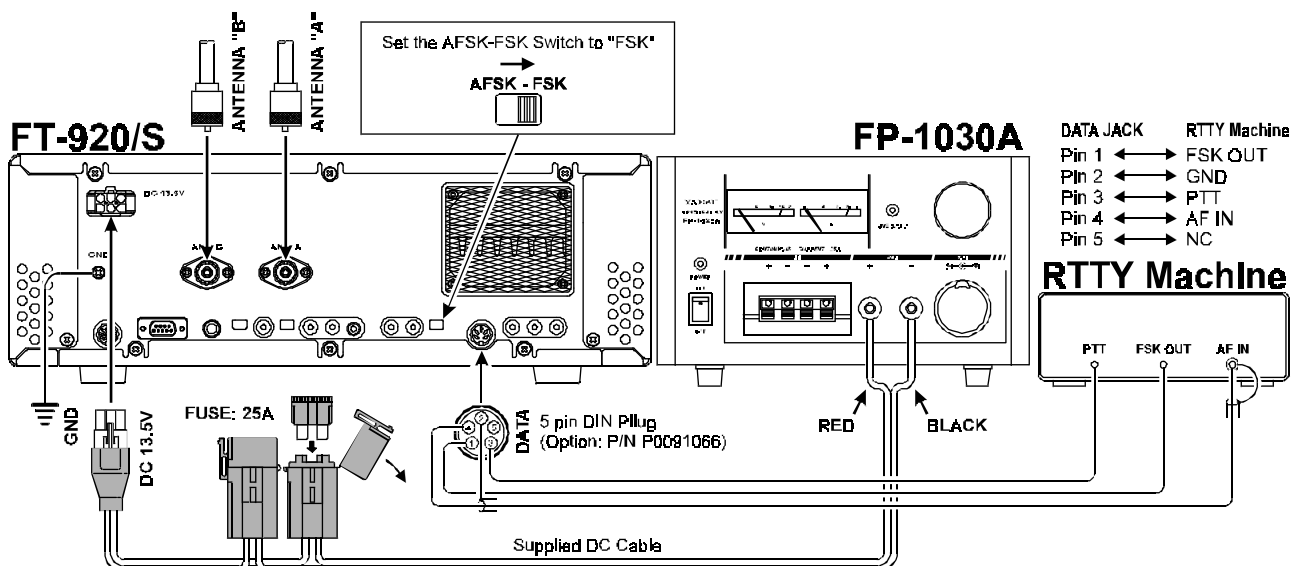

# Accessory Installation

## 4. CW Key/Paddle and Computer Keying Interface Suggestions

### Features

The FT-920 includes a host of features for the CW operator, the functions of which will be detailed in the "Operation" section later. These include:

- ① A built-in electronic keyer with message memory;
- ② A front-panel **KEY** jack for connection of a keyer paddle; and
- ③ A rear-panel **KEY** jack which may be connected to another keyer paddle or a straight key, TNC, or computer CW keying interface (for use with contest software, etc.).

Both **KEY** jacks on the FT-920 utilize "positive" keying voltage. Key-up voltage is approximately +5V DC, and key-down current is approximately 0.5 mA. When connecting a key or other device to the **KEY** jacks, use *only* a 3-pin ("stereo") ¼" phone plug; a 2-pin plug will place a short between the ring and (grounded) shaft of the plug, resulting in a constant "key-down" condition in some circumstances.

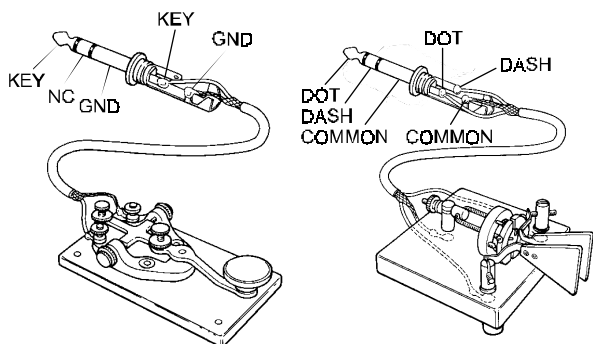

### Configuration Suggestions

- ① For everyday operation using the internal electronic memory keyer, connect your paddle to the *front panel* **KEY** jack, and activate the front panel **KEYER** switch. If you wish to keep the keyer paddle's cable out of the way, connect the plug, instead, to the rear panel **KEY** jack, and set the rear-panel **PDL-KEY** switch to **PdL**.
- ② If two operators are using the FT-920 simultaneously (for a contest, Field Day, etc.), a second keyer paddle may be connected to the *rear panel* **KEY** jack. Be sure that the rear panel's **PDL-KEY** switch is set to **PdL** so that both operators have access to the internal electronic memory keyer, and switch the front panel **KEYER** switch on.
- ③ If two operators are using the FT-920 simultaneously, but both wish to use a straight key, "bug," or an outboard electronic keyer, the key plugs may be inserted into the front and rear panel **KEY** jacks; now turn the front panel's **KEYER** switch off. Irrespective of the setting of the **PDL-KEY** switch, the tip connections on both Key plugs will serve as "Straight Key" lines for accommodating this application.
- ④ If you are using a computer-driven CW keying interface (with contest software), but want to be able to send occasional "repeat" messages quickly using the FT-920's *internal* keyer, connect your *keyer paddle* to the *front panel* **KEY** jack, and the *keying interface* line (which emulates a straight key) to the *rear panel* **KEY** jack. In this configuration, set the rear panel's **PDL-KEY** switch to the **KEY** position, which re-configures *only* the rear panel's **KEY** jack to accept a "Manual" keying line.

Note that the rear-panel **KEY** jack carries the capability to support an external PTT line, if provided by your external keyer, TNC, or computer keying interface.

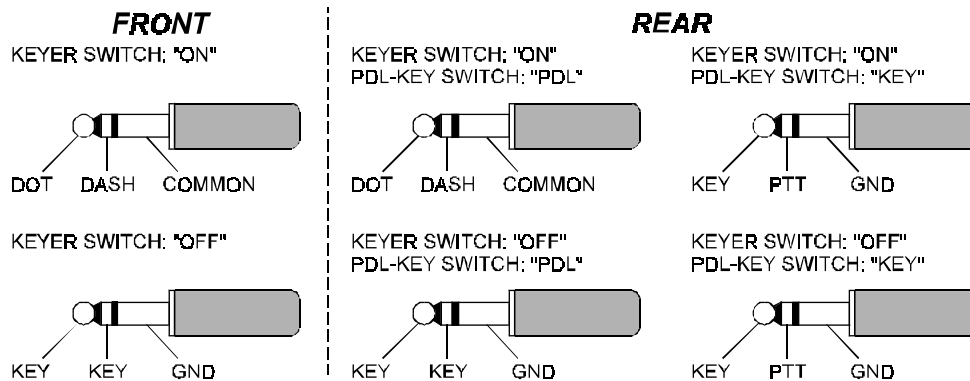



## 5. Antenna Connections

The FT-920's three antenna connectors, plus innovative microprocessor-based memory and switching circuits, provide excellent flexibility in setting up your antenna connections.

Typical antenna configurations are shown below. Remember that Antenna A and Antenna B (which are "SO-239" or "M" connectors) may be used for transmission and reception, while the RX Antenna port (which is an "RCA" type connector) may only be used for reception.

### Note

#### Regarding Large Receive Antennas

Although surge suppression is provided on all antenna ports, you may wish to consider building a simple external circuit which will disconnect, on TX, any antenna connected to the **RX ANT IN** jack, particularly if you are using a very long wire antenna such as a Beverage. Very long antennas can build up very high RF and static voltages on them, and the circuit below may provide better protection for your receiver's input circuitry.

## 6. Personal Computer Interfacing for Contest Software, etc.

The FT-920 features a built-in level converter, allowing direct connection from the rear-panel CAT jack to the serial port of your computer, without the need for any external converter box.

When your software requests serial port configuration information, set it for "4800,N,8,2" (4800 baud, No Parity, 8 Data Bits, and 2 Stop Bits). Be certain to configure and activate any required "TSR" (Terminate-and-Stay-Resident) utilities before beginning computer-controlled transceiver operation (your software's instruction manual will describe any such requirement).

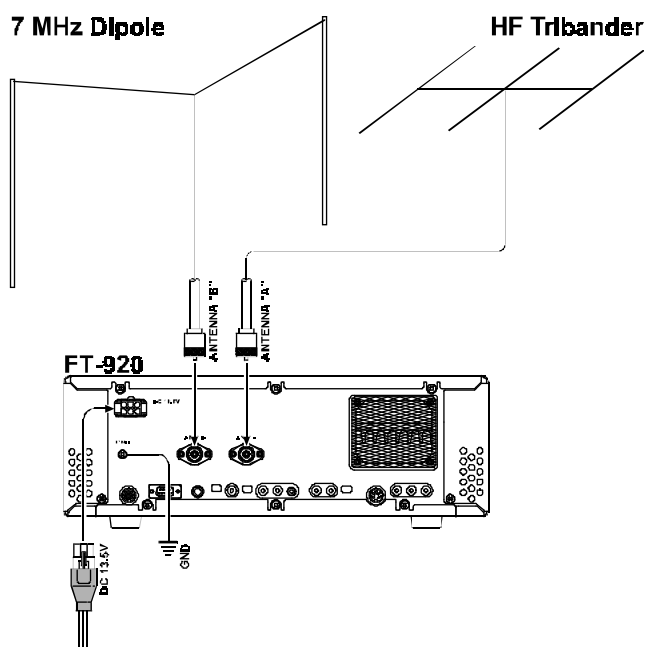
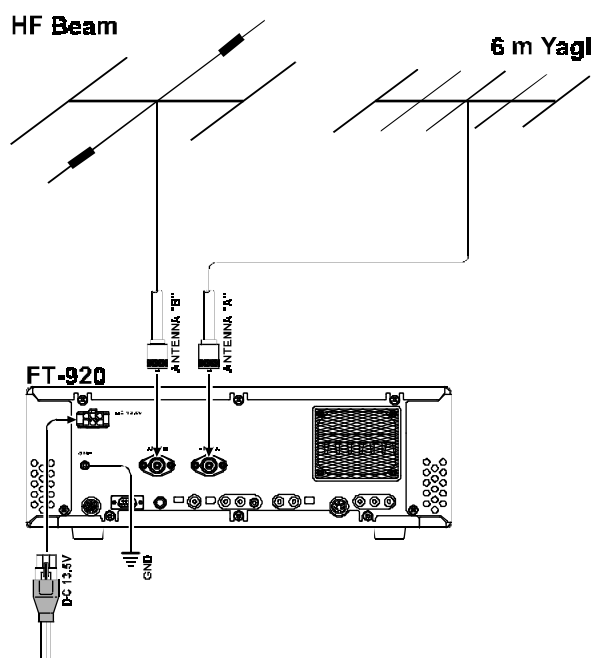

# Front Panel Controls, Switches, & Jacks

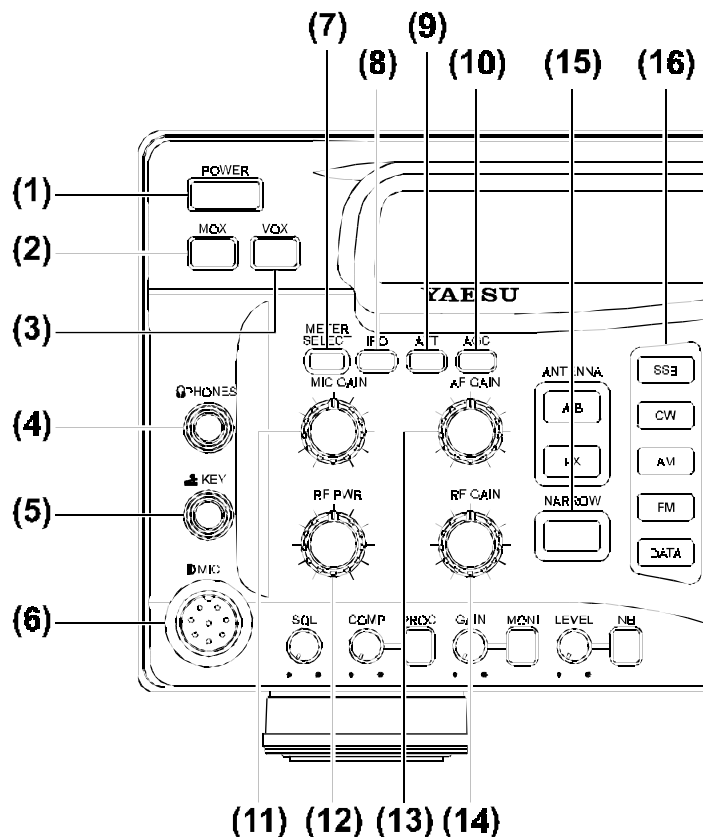

## (1) POWER Switch

This latching-type switch turns the FT-920 on and off. Push it once to turn the transceiver on, and press it again to turn the power off.

## (2) MOX Switch

This also is a latching-type switch, used to switch the FT-920 manually into the transmit mode (instead of using the microphone Push-To-Talk (PTT) switch, for example). Press **[MOX]** once to activate the transmit mode, and press it again to release the FT-920 back into the receive mode.



Be sure to have an antenna or dummy load connected to the transceiver when this switch is pushed. Failure to do so may cause damage to the transmitter's final amplifier stage.

## (3) VOX Switch

This switch enables automatic voice-actuated transmitter switching in the SSB, AM, and FM modes, as well as "semi-break-in" CW. Press the **[VOX]** switch once to activate VOX, and again to disable VOX (and return to PTT operation).

## (4) PHONES Jack

This 1/4" 3-pin jack is used for connection of headphones. When a plug is inserted into this jack, the internal/external speaker will be cut off. This jack is optimized for use with 16  $\Omega$  to 32  $\Omega$  headphones, and will accept either monaural or stereo headphone types.

## (5) KEY Jack

This 1/4" 3-pin jack is used for connection of a CW keyer paddle or a straight key. Use only a 3-pin ("stereo") plug in this jack; if you attempt to use a 2-pin plug, a constant CW carrier will be sent out. The pinout is shown on page 5.

## (6) Mic Jack

This 8-pin connector accepts microphone input, as well as providing PTT, ground, and scanning control access. Proper microphone impedance is 500 ~ 600  $\Omega$ .

# Front Panel Controls, Switches, & Jacks

## (7) METER SELECT Switch

This switch is used to select the display function of the transmission multimeter, with the selections being provided in the following sequence:

- ALC:** ALC Voltage.
- SWR:** SWR as observed by the transmitter PA.
- COMP:** Speech Processor Compression level.
- VOLT:** Final amplifier transistor supply voltage (also displayed on receive).
- AMP:** Final amplifier transistor drain current.
- ALC:** ALC Voltage (return to beginning of loop).

## (8) IPO Switch

The Intercept Point Optimization button switches the receiver RF preamplifier on and off. When the switch is pressed, the “IPO” icon appears on the display panel, and the receiver RF preamplifier is bypassed. When this switch is pressed again, “IPO” will disappear, and the RF preamplifier returns to operation.

Best receiver sensitivity occurs when “IPO” is off. However, the RF preamplifier may not be necessary in noisy locations or on the lower frequencies, in which case the IPO feature will provide improved immunity from intermodulation.

## (9) ATT Switch

This switch may be used to reduce the input receive signal in one S-Unit steps, starting at 0 dB (no attenuation), and sequencing through [6 dB] → [12 dB] → [18 dB] → [0 dB]. . .

The attenuation level is shown on the display panel. Best sensitivity will, of course, occur when no attenuation is used.

## (10) AGC Switch

This switch selects the recovery time for the receiver AGC (Automatic Gain Control) system. The selections available are, in order:

- AGC FAST:** Fast receiver recovery time.
- AGC SLOW:** Slow receiver recovery time.
- AGC OFF:** AGC system disabled.
- AGC FAST:** Fast receiver recovery time (return to beginning of loop).

The current receiver recovery time constant is shown on the display panel.

⚠ If “AGC OFF” is selected, the S-meter (which monitors AGC voltage) will cease to function.

## (11) MIC GAIN Control

This control adjusts the microphone input level in the SSB and AM modes. Clockwise rotation increases the microphone gain level.

## (12) RF PWR Control

This control adjusts the transmitter’s power output, with a range of 10 ~ 100 Watts, and adjustment is available in all modes. Clockwise rotation increases the power output.

## (13) AF GAIN Control

This control adjusts the receiver volume level presented to the speaker or headphones. Clockwise rotation increases the volume level.

⚠ Note that this control does not affect the audio level presented to the rear-panel **AF Out** and **DATA** jacks.

## (14) RF GAIN Control

This control adjusts the gain of the receiver’s RF and IF stages. Clockwise rotation increases the RF Gain level for best sensitivity, and the normal operating position for this control is fully clockwise.

⚠ Counter-clockwise rotation of the RF GAIN control, besides lowering the receiver gain level, will cause the S-meter to deflect upward, as though a strong signal were present.

## (15) NARROW Switch

This switch is used to activate optional narrow filters, for improved interference rejection. Press this switch to select the narrow filter; the “NAR” indicator will appear on the display panel.

## (16) MODE Switches

Pressing one of these switches selects the operating mode. Per the chart below, repeated presses of a particular switch may cause the precise mode to be selected from within a mode group (for example, pressing [**SSB**] repeatedly toggles between [**USB**] and [**LSB**]).

Mode Switch	Available Mode Selections
<b>SSB</b>	LSB ↔ USB
<b>CW</b>	CW (LSB) ↔ CW (USB)
<b>AM</b>	AM
<b>FM</b>	FM
<b>DATA</b>	DATA LSB → DATA USB → DATA FM → DATA LSB → (RTTY/FSK) (PKT/AFSK) (PKT/AFSK) (RTTY/FSK)

# Front Panel Controls, Switches, & Jacks

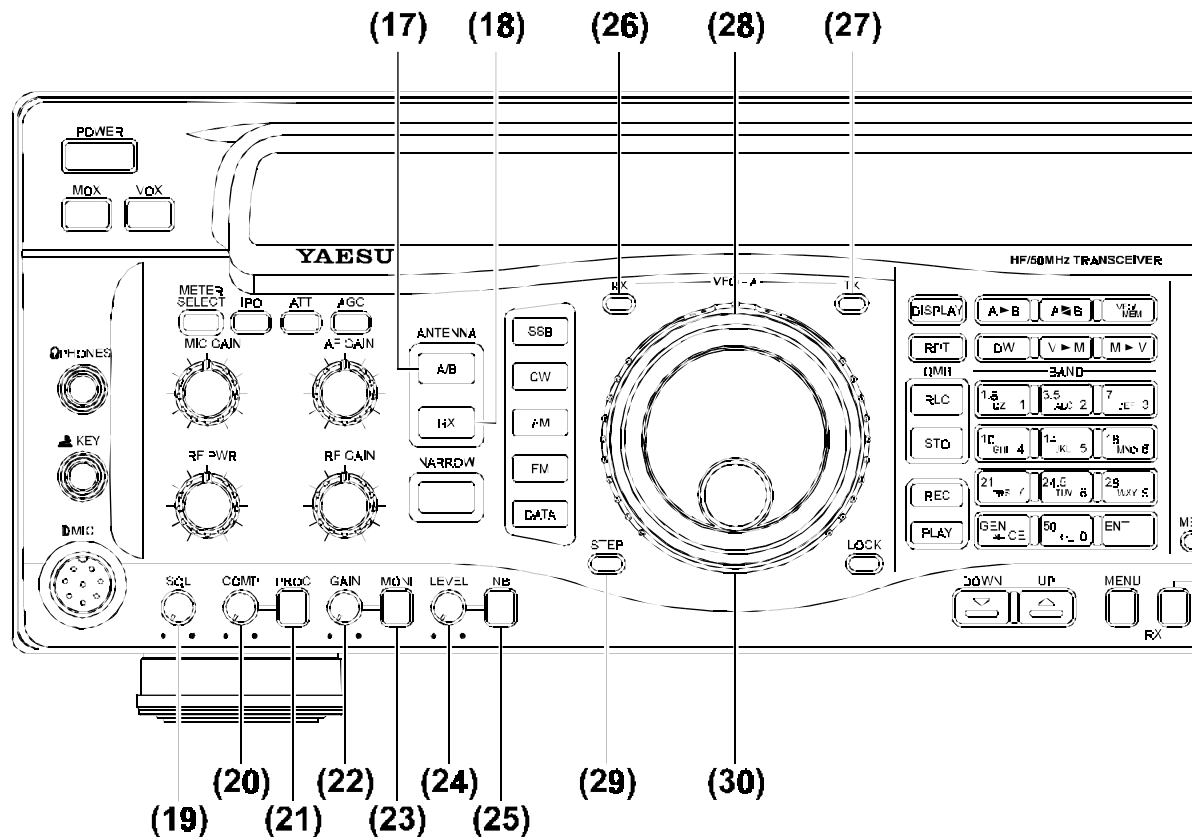

## (17), (18) Antenna Switches (A/B, RX)

These switches allow selection of antennas, per the information and illustration below.

**(17) A/B** Press this switch to toggle between antennas connected to the “A” and “B” connectors on the rear panel. The indicator “ANT[A]” or “ANT[B]” will appear on the display panel to indicate which antenna is in use. The antenna selection will be maintained in the VFO or Memory register in use.

**(18) Rx** When this switch is pressed, the receiver’s input is connected to the receive-only “Rx In” RCA connector on the rear panel of the FT-920. This feature allows connection of a low-noise receiving antenna or a VHF/UHF receive converter. When the Rx button is pushed, the “Rx Ant” indicator will appear on the display panel. See the drawing on the next page for details.

## (19) SQL (Squelch) Control

This control, active in all modes, may be used to silence background noise when no signal is present. Most frequently used during FM operation, this control must be rotated fully counter-clockwise for most SSB, CW, or AM operation.

## (20) PROC COMPRESSION Level Control

This control is used to adjust the compression level of the digital speech processor during SSB operation. Clockwise rotation increases the compression level.

## (21) PROC Switch

Pressing this switch activates the digital SSB speech processor, for enhanced “talk power” under difficult conditions. The “PROC” indicator will appear on the display panel when the speech processor is activated. Press this switch again to turn the speech processor off.

## (22) MONI GAIN Control

This control is used to adjust the audio level of the voice monitor. Clockwise rotation increases the audio level.

## (23) MONI Switch

Pressing this switch activates the voice monitor, which allows the operator to monitor voice characteristics during adjustments. When the monitor is activated, the “Moni” indicator appears on the display panel. Press this switch again to turn off the monitor.

# Front Panel Controls, Switches, & Jacks

## (24) NB LEVEL Control

This control adjusts the blanking level for the IF Noise Blanker. Clockwise rotation increases the degree of blanking.

## (25) NB Switch

Pressing this switch activates the IF Noise Blanker. When the Noise Blanker is activated, the 'NB' indicator will appear in the display panel. Press this switch again to switch the Noise Blanker off.

✂ The IF Noise Blanker may be used or alone or in conjunction with the DSP Noise Reduction feature.

## (26) RX - (VFO-A) Indicator/Switch

This combination LED/Switch indicates the operating status of VFO-A in the receive mode. The LED appears green when the receiver is set up for the use of VFO-A.

This LED is also a switch; when the receiver is using VFO-A, pressing the green LED will cause the receiver to be muted (the LED will now blink). Press the LED again to cancel the mute function.

## (27) TX - (VFO-A) Indicator/Switch

This combination LED/Switch indicates whether or not VFO-A is being used to determine the transmit frequency. The LED appears orange when the transmitter is being controlled by VFO-A (this is the *typical* situation for transceive operation using VFO-A).

When the corresponding LED near the tuning dial for VFO-B is pushed, the VFO-A [TX] LED will go out, showing that VFO-A has relinquished transmit frequency control. Pushing the VFO-A [TX] LED again will restore transmit frequency control to VFO-A.

If this LED is pushed while it is already illuminated, the FT-920 will be placed in the (reduced-power: Approx. 10 W) "TX MUTE" mode. In this mode, the Orange LED will *blink*.

## (28) VFO-A Tuning Dial

This large knob is the main tuning dial for the transceiver, controlling the frequency of the (main) VFO-A. Clockwise rotation of the knob increases the frequency, while counter-clockwise rotation decreases the frequency. The tuning steps of the rotary encoder coupled to the VFO-A Tuning Dial are shown below.

Operating Mode	STEP		
	Normal	Fast	Fine
SSB, CW, DATA(SSB)	10Hz	100Hz	1Hz
AM, FM, DATA(FM)	100Hz	1kHz	10Hz

## (29) STEP Switch

Use the [STEP] switch to enable fine or coarse tuning when using the VFO-A or VFO-B tuning dials, as well as the [Up▲] or [Down▼] switches. The [step] switch toggles the tuning steps through the following sequence:

**Fast → Fine → Normal → Fast → . . .**

The current setting will be indicated on the display panel.

## (30) Shuttle Jog Control

The outer, concentric "Shuttle Jog" control behind the VFO-A Tuning Dial allows fine or rapid frequency excursions with just a slight turn of your hand. Rotating the Jog ring slightly to the left or right initiates slow tuning in a downward or upward direction, respectively. The more you rotate the spring-loaded Jog dial, the faster the VFO will tune. The tuning rate of the Shuttle Jog may be programmed via the Menu system.

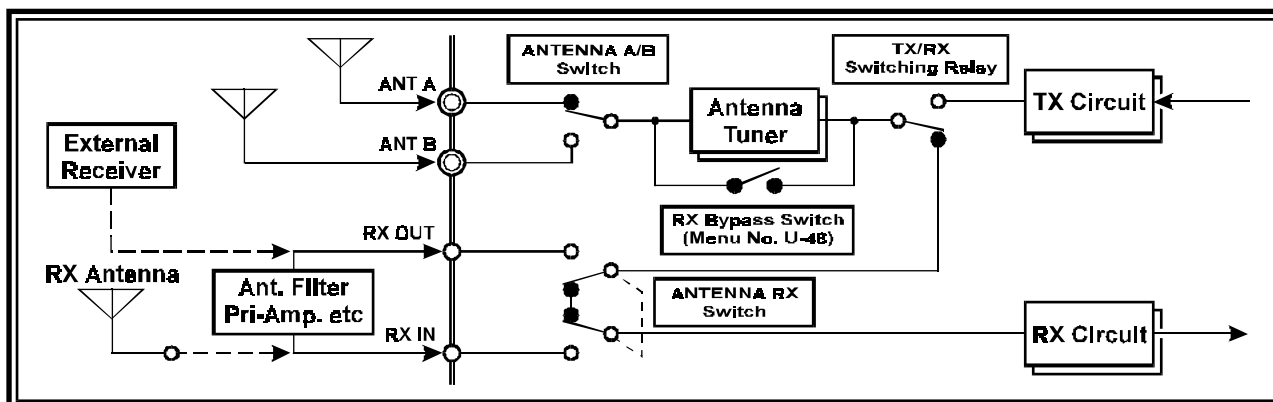

# Front Panel Controls, Switches, & Jacks

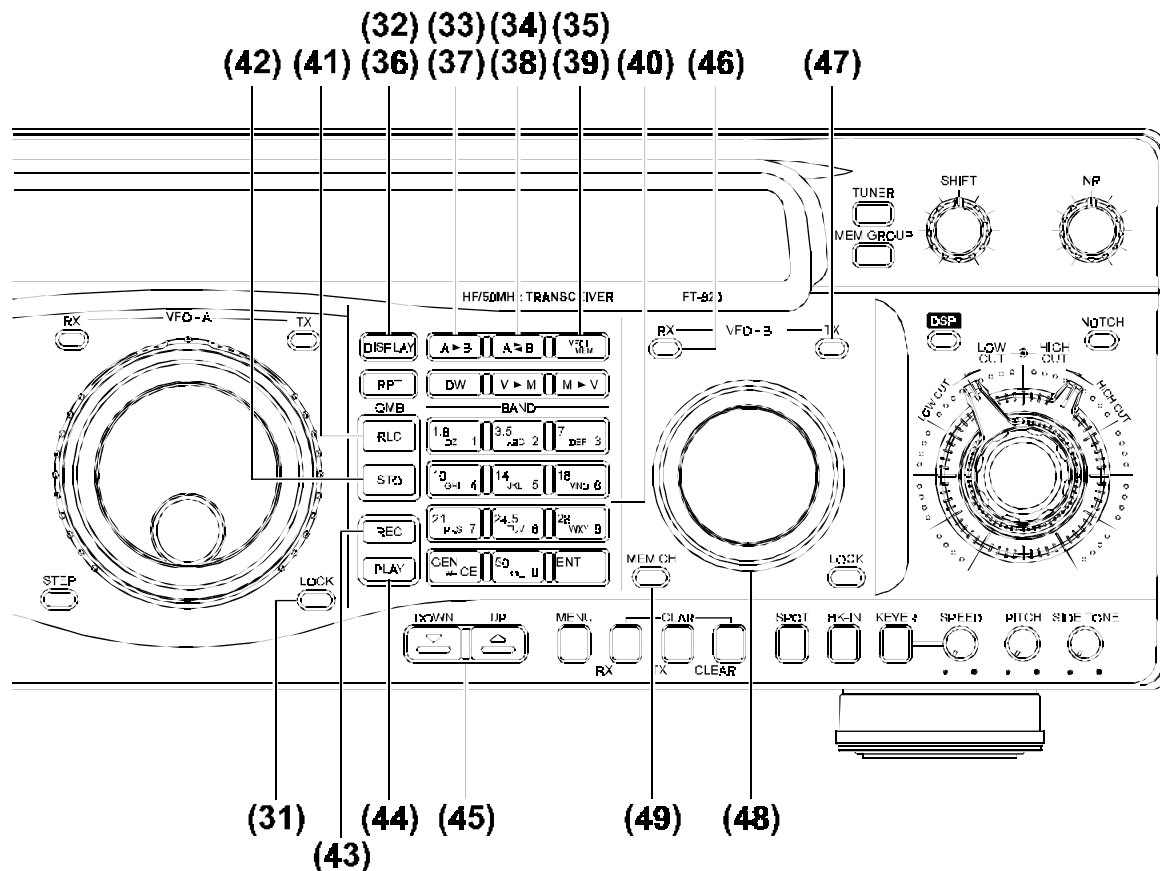

## (31) Lock Switch (A)

The [Lock] switch locks the settings of the VFO-A Tuning Dial and/or the Shuttle Jog. Press this switch momentarily to lock the Tuning Dial; press and hold it in for ½ second to lock the Shuttle Jog.

When either control is locked, the “Lock” indicator below the “VFO-A” indicator on the display panel will be illuminated.

## (32) DISPLAY Switch

This switch changes the function of the VFO-B read-out area of the display panel. In the normal mode, the VFO-B frequency is displayed. When this button is pushed, and you are operating in the MR (Memory Recall) mode, any alphanumeric memos (“Alpha-Tags”) you have programmed will be substituted in place of the frequency display on the VFO-B side. Press this switch again to return to the frequency display mode.

## (33) (VFO) A ► B Switch

Pressing and holding this switch in for ½ second causes the contents of VFO-A to be copied into VFO-B, so that the two VFOs’ contents will be identical.

## (34) (VFO) A ◄ B Switch

Pressing this switch momentarily to swap the contents of VFO-A with those of VFO-B.

## (35) VFO/MEM Switch

Pressing this switch changes frequency control between the VFO and Memory systems.

Repeatedly pushing this switch causes frequency control to toggle between the two systems.

## (36) RPT Switch

Pressing this switch, while on 28 MHz in the FM operating mode, causes a standard repeater shift (default: 100 kHz) to be applied to the operating frequency during transmission; additionally, a (subaudible) CTCSS encode tone (default: 88.5 Hz) will be superimposed on your transmitted signal, for accessing repeaters requiring it.

Both the CTCSS tone frequency and repeater shift may be changed via the Menu system.

## (37) DW Switch

Pressing this switch activates the **Dual Watch** feature.

# Front Panel Controls, Switches, & Jacks

## (38) V ► M Switch

Pressing this switch for ½ second transfers the contents of VFO-A into a memory register.

## (39) V ► M Switch

Pressing this switch for ½ second transfers the contents of the currently-selected memory channel into VFO-A.

## (40) Keypad

The keypad is used for one-touch band selection, as well as direct frequency entry, during VFO operation.

During FM transmission, the Keypad also serves as a DTMF Encoding Keypad for Autopatch operation.

## (41) QMB RCL Switch

This switch is used for one-touch recall of **Quick Memory Bank** memories. Pressing this switch causes the QMB memories to be recalled sequentially.

## (42) QMB S<sub>TO</sub> Switch

This switch is used for storing VFO-A frequencies into the QMB memory registers.

## (43) REC Switch

Pressing this switch causes the built-in Digital Recorder to start recording the contents of the receiver's incoming audio. Pressing the **REC** switch for ½ second, followed by the [1], [2], [3], or [4] key on the Keypad, causes the Digital Voice Message recorder to start recording.

## (44) PLAY Switch

Pressing this switch initiates playback of the receiver's Digital Recorder.

## (45) UP (▲) / DOWN (▼) Keys

Pressing these keys allows quick frequency jumps (during VFO operation) or memory channel selection (during Memory Recall operation). Pressing either of these switches once (momentarily) causes the frequency or memory channel number to move upward or downward by one increment; pressing and holding a switch in causes continuous frequency or channel number change.

The increments for frequency change during VFO operation, using these switches, are shown below.

STEP SWITCH POSITION		
NORMAL	FAST	FINE
100kHz	1MHz	10kHz

## (46) RX - (VFO-B) Indicator/Switch

This combination LED/Switch indicates the operating status of VFO-B in the receive mode. The LED appears green when the receiver is set up for the use of VFO-B.

This LED is also a switch; when the receiver is using VFO-B, pressing the green LED will cause the receiver to be muted (the LED will now blink). Press the LED again to cancel the mute function.

## (47) TX - (VFO-B) Indicator/Switch

This combination LED/Switch indicates whether or not VFO-B is being used to determine the transmit frequency. The LED appears orange when the transmitter is being controlled by VFO-B (this is a typical situation for "Split" operation using VFO-B for transmission while receiving on VFO-A).

When the corresponding LED near the tuning dial for VFO-A is pushed, the VFO-B [TX] LED will go out, showing that VFO-B has relinquished transmit frequency control. Pushing the VFO-B [TX] LED again will restore transmit frequency control to VFO-B.

If this LED is pushed while it is already illuminated, the FT-920 will be placed in the (reduced-power: Approx. 10W) "TX MUTE" mode. In this mode, the Orange LED will *blink*.

## (48) VFO-B Tuning Dial

This knob is the tuning dial controlling the frequency of the (Sub) VFO-B. Clockwise rotation of the knob increases the frequency, while counter-clockwise rotation decreases the frequency. The tuning steps of the rotary encoder coupled to the VFO-B Tuning Dial are shown below.

Operating Mode	STEP		
	Normal	Fast	Fine
SSB, CW, DATA(SSB)	10Hz	100Hz	1Hz
AM, FM, DATA(FM)	100Hz	1kHz	10Hz

## (49) MEM CH Switch

Pressing this switch changes the operating configuration for the VFO-B Tuning Dial.

If this switch is pressed, the VFO-B Tuning Dial will switch from VFO operation to Memory Channel selection. Press the switch again to return to VFO operation.

# Front Panel Controls, Switches, & Jacks

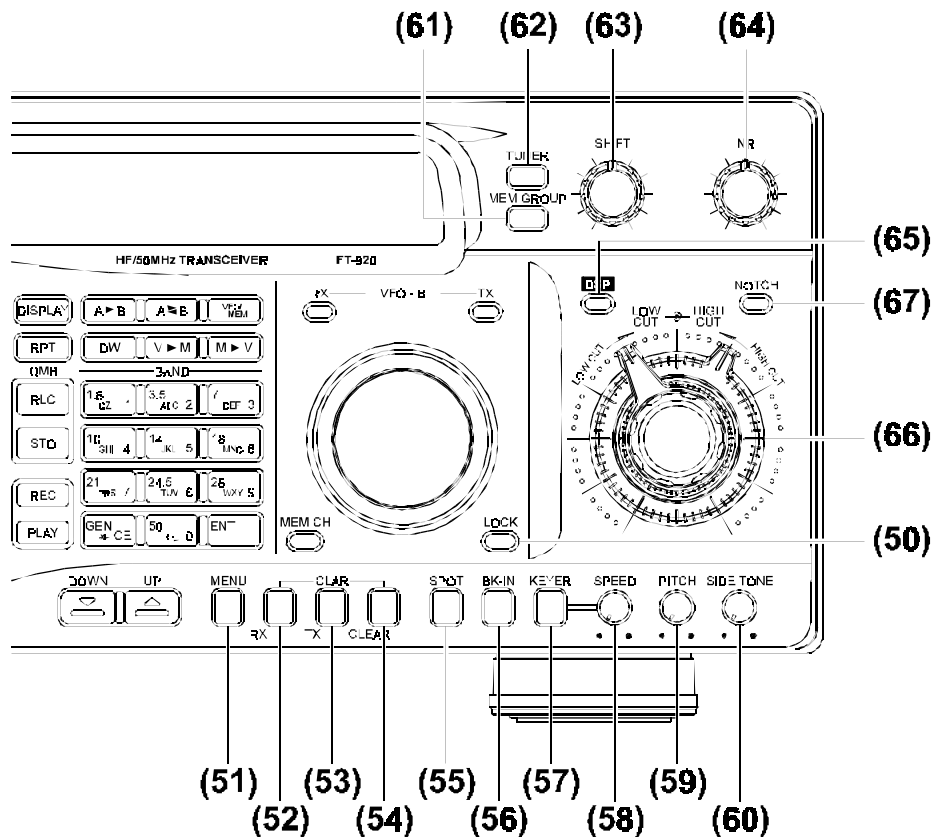

## (50) Lock Switch (B)

This switch locks the settings of the VFO-B knob and/or the front panel keys.

Pressing this switch momentarily locks the settings of the VFO-B Tuning Dial. Pressing and holding in this switch for ½ second causes all the keys on the front panel of the transceiver (except for the [Lock] switches!) to be locked. When the Lock function is engaged, the “Lock” indicator will be shown on the display panel.

## (51) MENU Switch

Pressing this switch momentarily activates the “Menu” mode, which allows customization of many aspects of transceiver configuration.

## (52) RX CLAR Switch

Pressing this switch activates the RX Clarifier (Offset Tuning from VFO-A frequency) feature. When this feature is activated, the VFO-B Tuning Knob is used for Clarifier tuning up to an offset of  $\pm 9.99$  kHz.

## (53) TX CLAR Switch

Pressing this switch activates the TX Clarifier feature, allowing the transmit frequency to be offset from the VFO-A frequency up to  $\pm 9.99$  kHz. The TX Clarifier may be used in conjunction with the RX Clarifier, or the chosen offset may be applied either to the RX or TX frequency singly.

## (54) CLEAR CLAR Switch

Pressing this switch clears any offset that has been established for the Clarifier, returning it to a “Zero Offset” condition. Pressing this switch only cancels the *offset*, it does *not* turn the Clarifier itself off.

## (55) SPOT Switch

In the CW mode, this switch activates a spotting tone, used for precise zeroing in onto an incoming (RX) signal. By matching the pitch of the incoming signal exactly to the pitch of the Spot tone, your transmitter’s signal will be precisely aligned to a “Zero Beat” position relative to the other station’s signal.



# Front Panel Controls, Switches, & Jacks

## (56) BK-IN Switch

Pressing this switch, in the CW mode, places the transceiver in the “Full Break-In” (“QSK”) mode.

## (57) KEYSER Switch

This is the On/Off switch for the built-in Electronic Keyer.

## (58) SPEED Control

This is the Speed control for the built-in Electronic Keyer. Clockwise rotation increased the sending speed.

## (59) PITCH Control

This control adjusts the pitch of (A) the SPOT tone, (B) the corresponding pitch of your FT-920's transmitted carrier, and (C) the center frequency of the receive passband. The available range of frequencies is 300 ~ 1050 Hz, in 50 Hz steps.

## (60) SIDE TONE Control

This control adjusts the level of the CW monitor sidetone. Clockwise rotation increases the monitor level.

## (61) MEM GROUP Switch

This switch is used to select the “Memory Group Recall” mode of Memory operation. In this mode, only those memory channels within the designated group will be available for recall; this is useful in reducing channel selection time if you only are interested in watching a few particular channels.

## (62) TUNER Switch

This is the On/Off switch for the FT-920's Automatic Antenna Tuner.

Pressing this switch *momentarily* places the Antenna Tuner in line.

Pressing and holding in this switch for ½ second activates the Automatic Matching mode, in which a carrier is generated and the tuner's microprocessor-based circuitry selects values of inductance and capacitance so as to present a low SWR to the transmitter's output port.

- Be certain to have an antenna or dummy load connected to the antenna jack on the rear of the transceiver before initiating Automatic Antenna Tuner matching procedures.

## (63) SHIFT Control

This control adjusts the receiver's IF Shift feature, which adjusts the 8.2 MHz IF position relative to the center frequency of the selected IF filter (in all modes except FM). The default position for this control is at 12 o'clock, and an adjustment range of  $\pm 1.26$  kHz is provided (the pitch of the incoming signals will not change).

## (64) NR Control

This control adjusts the level of the DSP-based Noise Reduction feature. Clockwise rotation of this control increased the degree of noise reduction.

## (65) DSP Switch

This is the On/Off switch for the Digital Signal Processing circuitry.

## (66) Low Cut/HIGH CUT Controls

These controls adjust the passband cutoff frequencies of the receiver's High-Cut and Low-Cut DSP filters. The inner control adjusts the Low-Cut characteristics, with a physical adjustment range over the left hemisphere. The outer control adjusts the High-Cut characteristics, and its adjustment range is over the right hemisphere.

Do not attempt to adjust either of these controls past the 12 o'clock position.

## (67) NOTCH Switch

This is the On/Off switch for the beat-canceling DSP Notch filter.

# Display Panel Indicators and Icons

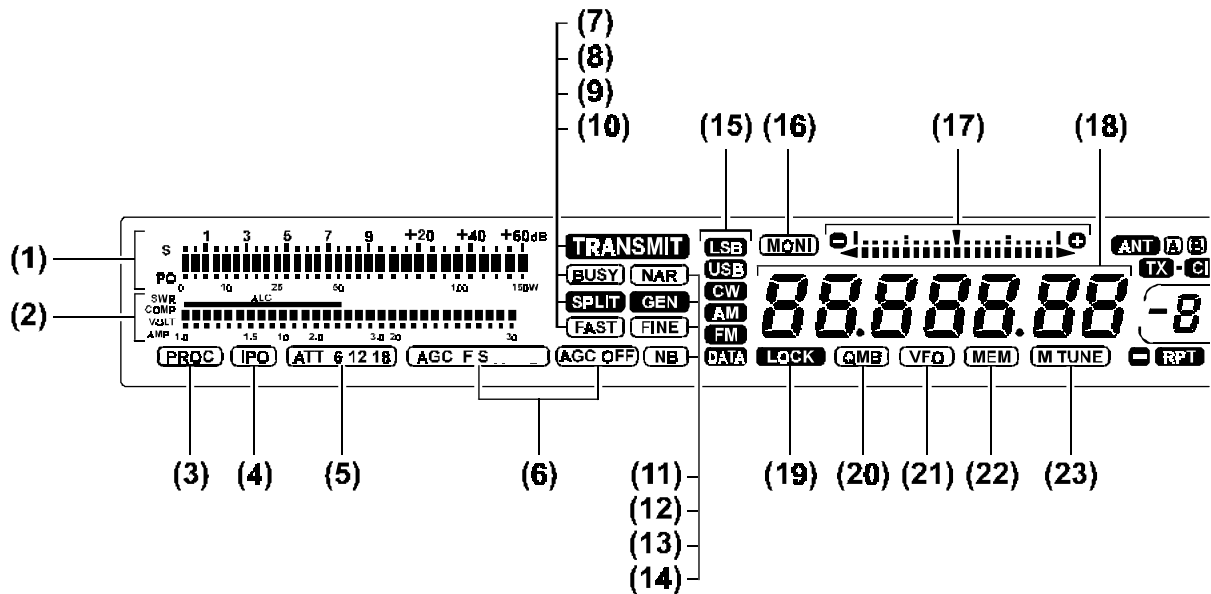

## (1) S/P O Meter

This meter scale indicates signal strength on receive, and power output on transmit. The characteristics may be changed between Instantaneous and Peak-Hold by making the appropriate selection via Menu Item U-07.

## (2) Transmit Multimeter

In accordance with the corresponding setting of the Meter Select switch, these meter scales provide display of the following transmitter performance parameters:

**ALC:** ALC Voltage.

**SWR:** SWR as observed by the transmitter PA.

**COMP:** Speech Processor Compression level.

**VOLT:** Final amplifier transistor supply voltage (also displayed on receive).

**AMP:** Final amplifier transistor drain current.

## (3) [PROC]

This icon indicates that the Digital Speech Processor is On.

## (4) [IPO]

This icon indicates that the Intercept Point Optimization condition for the receiver is active, with the input preamplifier being bypassed.

## (5) [ATT 6 12 18]

This icon is illuminated when the receiver input preamplifier is On, and it displays the number of dB of attenuation.

## (6) [AGC F S] [AGC OFF]

These icons indicate the current operating mode for the Automatic Gain Control circuitry.

## (7) [TRANSMIT]

This icon becomes illuminated during transmission. If you attempt to transmit outside of an authorized transmit range, this icon will disappear, and "ERROR" will appear on the main frequency display area.

## (8) [BUSY]

This icon is illuminated during reception so long as the receiver is unskelched. By keeping the SQUELCH control fully counter-clockwise, receiver audio will always be present and the [BUSY] icon will stay lit.

## (9) [SPLIT]

This icon is illuminated during "Split" operation using VFO-A for reception and VFO-B for transmission, or vice-versa.

## (10) [FAST]

This icon is illuminated when "Fast" synthesizer steps have been selected, for more rapid frequency navigation using the VFO-A and VFO-B Tuning Knobs, or the UP(▲)/(▼)DOWN switches. In the "Fast" mode, the frequency change is multiplied by a factor of 10.

## (11) [NAR]

This icon is illuminated when a Narrow filter (in those modes where one is available) has been selected.

# Display Panel Indicators and Icons

## (12) [GEN]

This icon is illuminated when the transceiver is tuned to a frequency outside one of the 500 kHz segments containing an Amateur band. Transmission will be inhibited when the [GEN] icon is lit.

## (13) [FINE]

This icon is illuminated when “Fine” synthesizer steps have been selected, for fine tuning using the VFO-A and VFO-B Tuning Knobs, or the **UP(▲)/(▼)DOWN** switches. The tuning rate, in the “Fine” mode, is 1/10th the “Normal” rate.

## (14) [NB]

This icon is illuminated when the IF **Noise Blanker** is turned on.

## (15) VFO-A Mode

These icons display the operating mode in use on VFO-A.

## (16) [MON]

This icon is illuminated when the voice monitor is activated.

## (17) Enhanced Tuning Scale

This meter scale provides a wide variety of information regarding the operation of the transceiver, depending on its configuration (via Menu Item U-10).

At the factory, the Enhanced Tuning Scale is set up so as to provide a visual representation of the DSP system’s bandwidth. Other configurations allow depiction of the Clarifier offset direction and magnitude, as well as tuning accuracy. See the discussion on page 74 for details.

## (18) VFO-A Frequency Display

This is the main frequency display for the transceiver’s primary (A) VFO. Display resolution to 10 Hz is provided.

## (19) [LOCK]

This icon is illuminated when the VFO-A “Lock” function is activated so as to prevent inadvertent frequency changes.

## (20) [QMB]

This icon is illuminated when frequency data is recalled from the **Quick Memory Bank**.

## (21) [VFO]

This icon is illuminated when frequency data is provided by the VFO system.

## (22) [MEM]

This icon is illuminated when frequency data is recalled from the **Memory** system.

## (23) [MEM TUNE]

This icon is illuminated when transceiver frequency control is in a pseudo-VFO mode known as “Memory Tune,” whereby a memory channel is used as a starting point for tuning using the VFO-A Tuning Dial.

# Display Panel Indicators and Icons

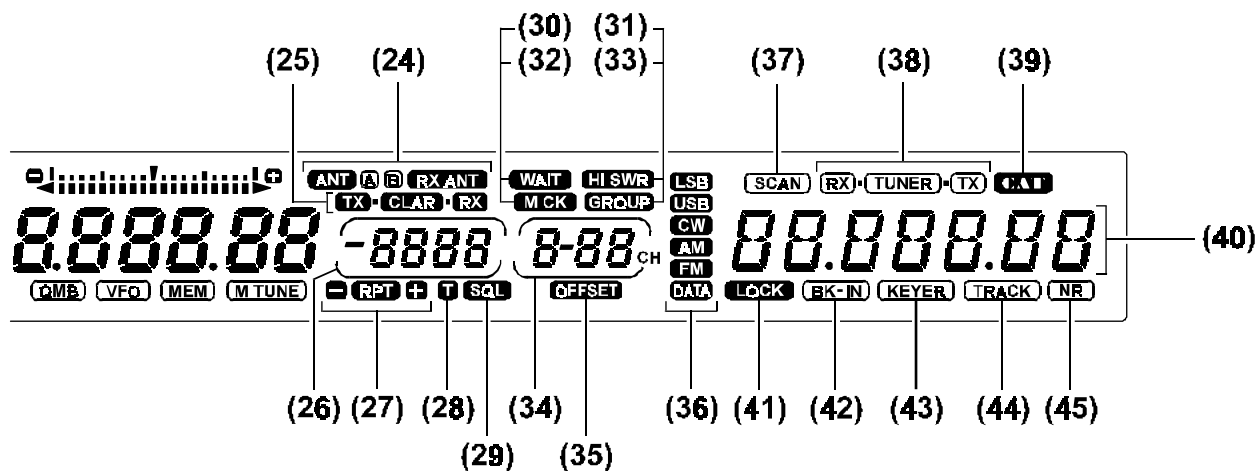

## (24) [ANT] [A] [B] [RX ANT]

These icons indicate which antenna is currently in use.

## (25) [TX] [CLAR] [RX]

These icons indicate the operating status of the Clarifier function. When the Receive Clarifier is on, [CLAR] [RX] will be displayed; when the Transmit Clarifier is on, [TX] [CLAR] will be displayed.

## (26) Multi-Panel

This panel of the display area provides quantitative data regarding transceiver operating status.

At the factory, this panel is set up to display the amount of Clarifier system frequency offset from the main VFO frequency. Other available functions include display of CW Pitch and VFO-A/VFO-B Offset, utilizing Menu Item U-09. See page 74 for details.

## (27) [-] [RPT] [+]

These icons are illuminated during "Repeater" FM operation, typically on 29 MHz. When the repeater shift direction is negative, the [-] [RPT] icons are illuminated; when the repeater shift direction is positive, the [RPT] [+] icons are lit.

## (28) [T]

This icon is illuminated when the CTCSS Tone Encoder is activated during FM Repeater operation.

## (29) [SQL]

This icon is illuminated when the CTCSS Tone Decoder is activate during FM repeater operation.

## (30) [WAIT]

This icon will be briefly illuminated during antenna tuning, before a satisfactory match has been achieved by the Automatic Antenna Tuner.

## (31) [Hi SWR]

If the Automatic Antenna Tuner is unable to achieve a satisfactory match, this icon will become illuminated. Transmitter power output will be significantly reduced when the [Hi SWR] icon is lit. You should check your antenna system, connectors, and cables to determine and repair the cause of the fault.

## (32) [M Ck]

This icon is illuminated when the "scratchpad" Memory Check mode is activated. In this mode, you may inspect and select the memory channel to be used *if and when* the Memory Recall mode is selected.

## (33) [GROUP]

This icon is illuminated when the Memory system is restricted to the Memory Group mode. See page 61 for details.

# Display Panel Indicators and Icons

## **(34) Memory Channel Display Field**

This area of the display indicates the Memory Channel number.

## **(35) [OFFSET]**

This icon is illuminated when the Multi-Display Panel is displaying the frequency offset of the Clarifier.

## **(36) VFO-B Mode**

These icons display the operating mode in use on VFO-B.

## **(37) [SCAN]**

This icon will be illuminated, during Memory operation, when the currently-selected Memory Channel has been tagged for inclusion among the channels to be scanned.

## **(38) [Rx] [TUNER] [Tx]**

These icons light up to indicate whether the Automatic Antenna Tuner is connected to the Receiver or Transmitter stage, respectively.

## **(39) [CAT]**

This icon will be illuminated when data is being passed to or from the transceiver's (serial) DATA port. During operation using software which "polls" the radio's status frequently, this icon may appear to be blinking.

## **(40) VFO-B Frequency Display**

This is the main frequency display for the transceiver's secondary (B) VFO. Display resolution to 10 Hz is provided.

## **(41) [Lock]**

This icon is illuminated when the VFO-B "Lock" function is activated so as to prevent inadvertent frequency changes.

## **(42) [BK-IN]**

During CW operation, this icon will be illuminated if Full Break-In (QSK) operation is selected.

## **(43) [KEYER]**

This icon is illuminated, in the CW mode, when the built-in Electronic Keyer is turned on.

## **(44) [TRACK]**

This icon will be illuminated during "VFO Tracking" operation, whereby VFO-A and VFO-B are "slaved" under control by the VFO-A Tuning Knob (press and hold in the VFO-A [Lock] key while rotating the tuning dial to engage VFO Tracking).

## **(45) [NR]**

This icon is illuminated when the DSP Noise Reduction circuitry is active.

# Rear Panel Connectors and Switches

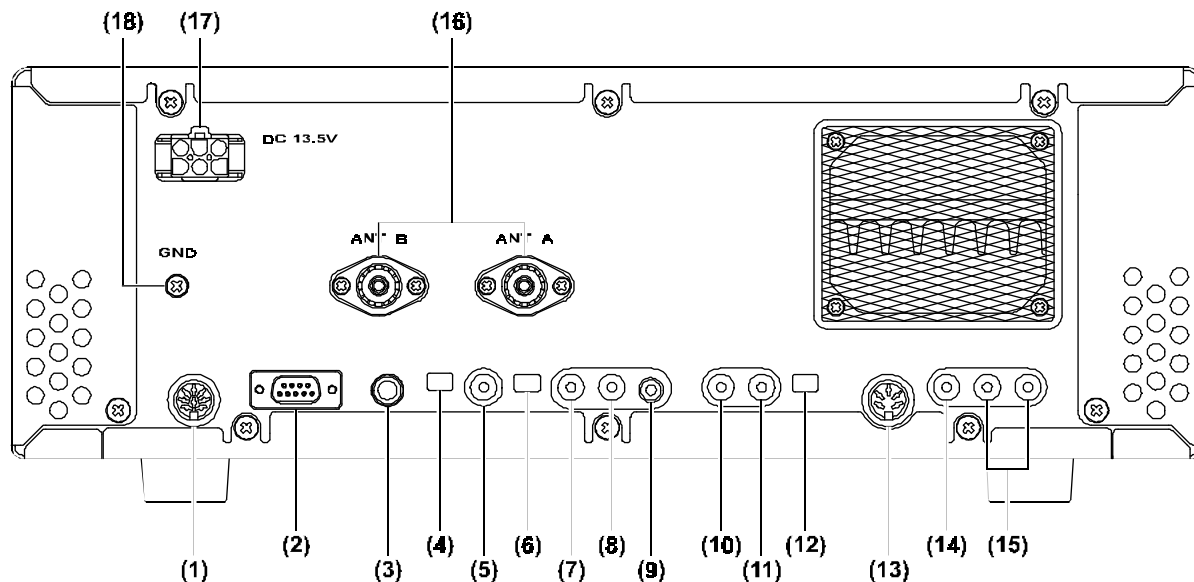

## (1) BAND Connector

This 8-pin interlocked DIN connector includes Tx/Rx switching and bandswitching control lines for use with the Yaesu Model FL-7000 Linear Amplifier.

## (2) CAT Port

This DB-9 connector is used for interconnection to a personal computer's serial port to enable computer-assisted operation. Use a standard (not "null modem") RS-232C serial data cable.

## (3) KEY Jack

This jack may be used for connection to a straight key, an external electronic keyer, a computer-driven CW keying interface, or a keyer paddle.

## (4) PDL-KEY Switch

This switch changes the function of the *rear-panel* KEY jack.

When the "PDL-KEY" switch is set to the "PDL" position, the rear-panel KEY jack will be connected in parallel with the front-panel KEY jack; when the "PDL-KEY" switch is set to "KEY," the *rear-panel* Key jack will be changed so as to accept a straight key, external electronic keyer, or computer-driven keying interface *while simultaneously allowing the front panel KEY jack to be connected to a keyer paddle for utilization of the built-in Electronic Keyer*. See page 18 for configuration details and operating tips.

## (5) PTT jack

This "RCA" female connector is used for connection of a footswitch or other external switch for Tx/Rx command control of the FT-920. This jack is wired in parallel with the front-panel MOX switch; shorting the PTT jack to ground causes the FT-920 to be placed in the Transmit mode, while opening the connection to the PTT jack returns the radio to the Receive mode. Open-circuit voltage is 13.5V DC, and short-circuit current is 15 mA.

## (6) TR-RY switch

This switch selects the switching device to be connected to the (adjacent) Tx GND jack, used for Tx/Rx control of peripheral devices such as linear amplifiers, etc. With the switch set to the RY position, the Tx GND jack is connected to a mechanical relay; if the switch is set to TR, the Tx GND jack is connected to a switching transistor. The specifications for these devices are shown in the next section.

## (7) Tx GND Jack

This RCA connector is connected to the switching device described above, for control of external devices. Please note the specifications for the two devices available via this jack:

The relay provides a mechanical closure to Ground on Transmit, while the (NPN) transistor switch sinks its (open) collector to ground on

<b>RY</b>
<b>60 Watts maximum</b> (AC 125V max. at 500 mA, DC 220V max. at 270 mA)
<b>TR</b>
<b>25 Watts maximum</b> (Positive DC Voltage Only, 50 V max. at 500 mA)

# Rear Panel Connectors and Switches

transmit. Check with the *manufacturer* of your amplifier (or other device) to confirm the switching voltage and current, if it is not clearly stipulated in the documentation for your equipment.

☑ Be absolutely certain to check the position of the **TR-RY** switch prior to connecting any external device to the **Tx GND** jack. Never connect an AC voltage, or a negative DC voltage, to the **Tx GND** jack if the **TR-RY** switch is set to **TR**. The Limited Warranty on this product does not cover damage caused by improper connections (excessive or improper voltage) to the rear panel jacks of the FT-920.

## (8) 13.5V Jack

This jack provides +13.5V DC at up to 200 mA for use with low-power peripheral devices. The jack is fused, and the current is limited by the size of the copper foil on the internal circuit boards; do not exceed the 200 mA current limitation.

## (9) EXT SP Jack

This 3.5 mm, 2-pin jack provides speaker audio output for an external speaker. The audio output impedance at this jack is  $4\ \Omega \sim 16\ \Omega$ , and the level varies according to the setting of the front panel's **AF GAIN** control.

## (10) AF OUT Jack

This is a fixed-level audio output jack for connection to a peripheral device such as a TNC, Morse code reader, or WeatherFax decoder. The audio output level provided is 100 mV at  $600\ \Omega$ , and the front-panel **AF GAIN** control has no effect upon the audio level present at the **AF OUT** jack.

## (11) PATCH Jack

This RCA jack is wired in parallel with the front panel's microphone input jack, providing a convenient input port for connection of a phone patch or other audio input. The audio input impedance is  $600\ \Omega$ , and the signal applied to the **PATCH** jack is affected by the setting of the front panel's **MIC GAIN** control.

## (12) AFSK-FSK Switch

This switch determines the method of (transmit) Data input to Pin 1 of the **DATA** jack (described below). If **AFSK** is selected, then Pin 1 should be connected to the "TX Audio" line from the TNC. If **FSK** is selected, then Pin 1 should be connected to the "FSK Out" line from the TNC or TU.

## (13) DATA Jack

This five-pin DIN jack accepts AFSK input or FSK (closure to ground) input from a Terminal Node Controller (TNC) or Terminal Unit (TU); it also provides fixed-level Audio Output, PTT, and Ground lines. The optimum AFSK Input level is 30 mV at  $3\ \text{k}\Omega$ , while the Audio Output level provided is fixed at 100 mV at  $600\ \Omega$ .

## (14) EXT ALC Jack

This RCA type connector may be used for connection to a linear amplifier's ALC cable. The specified control voltage range is  $0\text{V} \sim -4\text{V}$  DC, with -4V corresponding to the maximum degree of power reduction being applied to the FT-920.

## (15) RX ANT Jacks

These RCA connectors provide convenient access to the receiver input line for a number of applications. They are active only when the front-panel **[RX ANT]** key is pressed.

The **OUT** jack is connected to the "RX" lead from the main T/R relay for the transceiver.

The **IN** jack is connected to the input port of the FT-920 receiver section.

Accordingly, a separate receive-only antenna, or a VHF receive converter's 28 MHz output, may be connected to the **IN** jack. Alternatively, a receive preamplifier's Input jack may be connected to the **OUT** jack, and the preamp's Output jack may be connected to the **IN** jack. See page 35 for interface instructions and ideas.

## (16) ANT Jacks (A - B)

These SO-239 ("M") jacks should be connected to an appropriate coaxial connector for the antenna or a  $50\ \Omega$  dummy load. Antenna selection is made via the front-panel **[ANTENNA A/B]** switch.

## (17) DC 13.5V Jack

This is the main DC input jack for the transceiver. The specified voltage is 13.5V DC (negative ground) at 20 Amps.

## (18) GND Lug

For best performance and safety, this Ground Lug should be connected to a good earth ground, using a short, heavy, braided cable.

## *Bottom Panel*

---

The small adjustment hole, shown in the drawing, is used for adjustment of the “Beep” tone associated with front panel keystrokes.

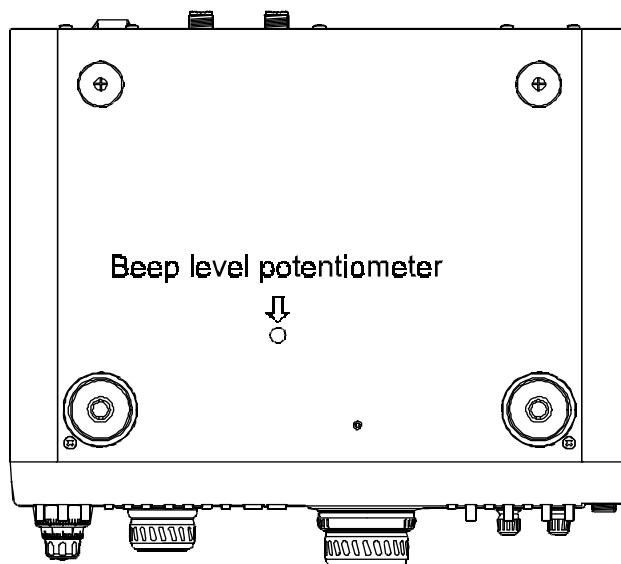



## Before You Start

Before you begin operation for the first time, preset the front panel controls and switches to the following positions:

<b>POWER, VOX, MOX:</b>	all off
<b>Mic GAIN:</b>	9 o'clock
<b>AF GAIN:</b>	9 o'clock
<b>RF POWER:</b>	fully clockwise
<b>RF GAIN:</b>	fully clockwise
<b>SHIFT:</b>	12 o'clock
<b>NR:</b>	12 o'clock
<b>LOW CUT:</b>	fully counter-clockwise (approximately 7 o'clock)
<b>HIGH CUT:</b>	fully clockwise (approximately 5 o'clock)
<b>SQL:</b>	fully counter-clockwise
<b>PROC LEVEL:</b>	fully counter-clockwise
<b>MONI LEVEL:</b>	fully counter-clockwise
<b>NB LEVEL:</b>	fully counter-clockwise
<b>SPEED:</b>	12 o'clock
<b>PITCH:</b>	12 o'clock
<b>SIDE TONE:</b>	12 o'clock

These represent typical starting points for operation; optimum setting procedures will be discussed later. Note that a wide variety of transceiver characteristics may be optimized or adjusted using the Menu System, discussed in detail beginning on page 69.

Connect your microphone and CW key/paddle to the appropriate jacks, then turn on your 13.5 Volt DC power supply.

## Receiving

Press the **POWER** switch to turn the transceiver on. Assuming that this is the first time you have used the FT-920, the display should look like this:

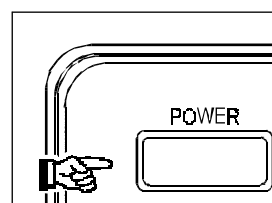

Inspection of the display will show you that both VFO-A and VFO-B are set to 7.000.00 MHz in the LSB mode. The (Green) [RX] and (Orange) [TX] LEDs associated with VFO-A should both be illuminated, indicating that all frequency control is being exercised by that VFO.

You should now be hearing background noise. Adjust the **AF GAIN** control for a comfortable listening level on the incoming background noise.

We will now discuss antenna selection, frequency navigation, and other aspects of FT-920 operation.

## Antenna Selection

Two main antenna jacks are provided on the rear panel of the FT-920, allowing you to connect, for example, a triband Yagi to one jack and a multiband dipole or vertical to the other.

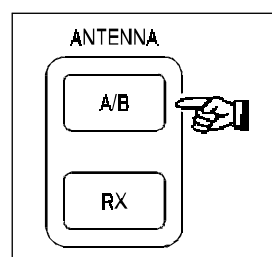

These "SO-239" or "M" type jacks, labeled **A** and **B**, may be selected by pressing the **ANTENNA A/B** switch on the left side of the transceiver's front panel. This switch toggles between the two available main antenna ports.

Note that the maximum power output for each antenna jack may be set independently via Menu Items U-49 (Antenna A) and U-50 (Antenna B). See page 79 for details.

An additional receive-only antenna jack (RCA type) may also be found on the rear panel of the transceiver, labeled **Rx In**. This jack may be connected to a specialized antenna, such as a loop or Beverage, for use in the receive mode; transmission will remain on the previously-selected **A** or **B** antenna if a receive-only antenna is used.

# Operation

To engage the receive-only antenna, press the **Rx ANTENNA** switch, located immediately under the **A/B** switch just described. Press the **Rx ANTENNA** switch a second time to return receive operation to the main (transmit) antenna (**A** or **B**).

- ☑ The antenna selection (**A**, **B**, and/or **Rx**) will be maintained in the VFO or memory register in use. Therefore, once you have set the transceiver up on each band of interest, you will not have to select the antenna manually (unless you *want* to change it) when you change bands or memories; the most recent setting will be retained.

## Mode Selection

Press one of the Mode switches, located immediately to the left of the VFO-A Tuning Dial, to select the operating mode. The available choices are **SSB**, **CW**, **AM**, **FM**, and **DATA**.

The **SSB** switch is a toggle function which allows the operator to choose between **USB** (used, by convention, above 10 MHz) and **LSB** (used below 10 MHz). Press the **SSB** switch, as necessary, to choose the appropriate SSB mode as we proceed with exploration of different bands.

The **CW** switch uses a toggle function to select between USB- and LSB-side injection (a.k.a. “CW-Reverse”). Although the default USB-side injection is typically used, you may wish to elect LSB-side injection below 10 MHz, particularly if you anticipate switching between LSB (voice) and CW frequently.

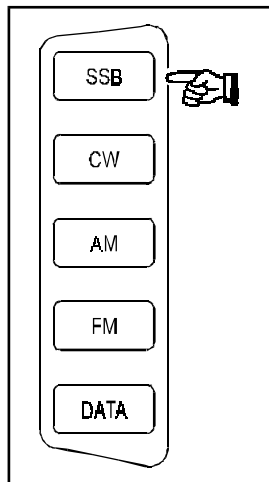

## Special Note for CW Mode Reverse CW Sideband

When you switch modes between CW and USB, you will observe that the frequency of the received signal stays the same (even though the *displayed* frequency may change slightly). You will also observe that the pitch of the received signal decreases as you increase the frequency by rotating the Tuning Dial.

However, switching from CW to *LSB* requires retuning the desired station. This can be particularly inconvenient when working a station in the 75-meter voice band (LSB) and you ask him to move to CW on the same frequency.

To eliminate the need for retuning in this situation, you may switch the receiver CW carrier injection point to the “reverse” (LSB) side. When you press [**CW**], you should notice that the “**USB**” indicator (just above “**CW**” on the main display) will blink for a couple of seconds, while the “**CW**” indicator glows steadily. This indicates that USB-side injection is currently in use. If you press [**CW**] once more, the “**LSB**” indicator will now blink, informing you that LSB-side injection is now in use.

When using LSB-side injection, you can freely switch between CW and LSB without having to retune the other station. Note that, in the LSB and CW/LSB modes, the received signal pitch now *increases* as you increase the VFO frequency.

To return the receiver to the (default) USB-side injection method, just push [**CW**] again.

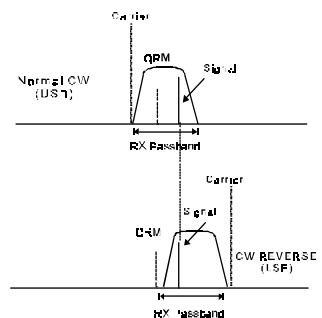

**Operating Hint** - An added benefit of this feature is the potential to eliminate interference. If you are experiencing QRM from a CW station that the IF Shift and/or DSP are unable to eliminate, you should try switching to the reverse CW sideband, retuning the desired CW signal, and adjust the IF Shift and/or DSP again.

## Bandwidth Selection

Optional filters are available from your Yaesu dealer for providing selectable IF bandwidths in the CW and AM modes. For CW, the optional YF-116C 500 Hz filter provides the narrow selectivity needed for today's crowded bands, while on AM, the YF-116A filter provides a 6 kHz bandwidth for improved listening fidelity.

Pressing the [**NARROW**] key on the front panel causes the narrower filter appropriate for that operating mode to be switched into the circuit. See the chart below for the bandwidths available in each mode:

NARROW Switch	CW	(RX) AM	(TX) FM
OFF	2.4kHz	Through or 6.0kHz <sup>2</sup>	WIDE FM (± 2.5 kHz)
ON	0.5kHz <sup>2</sup>	2.4kHz	NARROW FM (± 5 kHz)

- ❑ CW “Narrow” and AM “6 kHz bandwidth” operation requires installation of an optional filter.
- ❑ **In the AM mode**, when the optional AM filter is installed, the default bandwidth will be 6 kHz; pressing the [**NARROW**] key engages the (SSB) 2.4 kHz filter.
- ❑ **In the FM mode**, the action of the [**NARROW**] switch affects only the *transmitter*. For 29 MHz NBFM work, be sure to press the [**NARROW**] switch so as to set a maximum deviation of ±2.5 kHz, the statutory deviation limit on the 10-meter band. For 50 MHz, however, you will probably want to use the “Wide” configuration, which provides ±5 kHz deviation.

## Amateur Band Selection

### VFO-A Band Selection

One-touch Amateur band selection is provided via the Keypad, located between the VFO-A and VFO-B Tuning Knobs.

Press the [**14**] key to change VFO-A to the 14 MHz band. Initially, the operating frequency will be 14.000.00 MHz; rotate the VFO-A Tuning Knob to move around in the band. Press the [**CW**] key to set the operating mode to CW. Now press the [**10**] key; observe that the frequency is set to 10.000.00 MHz, and the mode is set to AM. Now press the [**7**] key, and observe that the mode has changed to LSB, the mode originally chosen on the 7 MHz band.. Press the [**14**] key, and observe that the mode has similarly reverted to CW, the last mode used on the 14 MHz band.

### VFO-B Band Selection

By pressing *and holding in* the Keypad's [**GEN/CE**] key for ½ second, frequency command control will be shifted from the VFO-A register to the VFO-B register.

For example, to set VFO-B to the 21 MHz band, press and hold in the [**GEN/CE**] key for ½ second; you will observe that the VFO-B frequency display area will *blink*. Within five seconds, press the Keypad's [**21**] key. After pressing the [**GEN/CE**] key for ½ second, you may also change the mode of operation and/or the antenna to be used, if you like.

- ✍ Note that pressing the [**GEN/CE**] key for ½ second does not, itself, *choose* VFO-B to be the receiving (or transmitting) VFO register. This action acts as a “scratchpad” function which allows VFO-B to be set on the frequency, mode, and antenna *to be used when VFO-B is next activated*.

# Operation

## Direct Keypad Frequency Entry

### VFO-A Direct Frequency Entry

A starting point on a band may also be established using direct entry via the Keypad. This is accomplished using the [ENT] key as well as the individual numeric keys on the Keypad. For the purposes of direct frequency entry, use the numerals located on the lower right-hand side of a particular key.

For example, to set 24.905.33 MHz on VFO-A, press:

[ENT]⇒[2]⇒[4]⇒[9]⇒[0]⇒[5]⇒[3]⇒[3]⇒[ENT].

Trailing digits which are identical (or acceptable for the new setting) need not be entered. Therefore in the above example (which began with the initial 12-meter band setting of 24.500 MHz), to set 24.900 MHz on the VFO-A register, one can simply press:

[ENT]⇒[2]⇒[4]⇒[9]⇒[ENT].

You can set the operating mode at the same time that you enter the frequency, if you need to make that change. To set VFO-A to 14.011.52 MHz CW, press:

[ENT]⇒[1]⇒[4]⇒[0]⇒[1]⇒  
[1]⇒[5]⇒[2]⇒[CW]⇒[ENT].

⚠ When entering a frequency below 10.000.0 MHz, you must enter the leading Zero of the desired frequency. That is, to enter 7.255.00 MHz, press:

[ENT]⇒[0]⇒[7]⇒[2]⇒[5]⇒[5]⇒[0]⇒[0]⇒[ENT].

### VFO-B Direct Frequency Entry

Direct VFO-B frequency entry using the Keypad again requires that the [GEN/CE] key be pressed and held in for ½ second, as described previously. Then enter the desired frequency while the VFO-B display area is blinking.

For example, to set VFO-B to 18.095.20 MHz, CW mode, press:

[GEN/CE](hold for ½ sec.)⇒[ENT]⇒  
[1]⇒[8]⇒[0]⇒[9]⇒[5]⇒[2]⇒[0]⇒[CW]⇒[ENT].

⚠ If you attempt to enter a frequency outside the operating range of the transceiver, the attempt will be ignored, and the transceiver will revert to the last frequency you were on before the attempted frequency entry.

## Stacked VFO System

The FT-920 provides two VFO registers on each band for each Tuning Dial (“A” and “B”). These dual registers are most often used to establish “favorite frequency” presets in each Amateur band.

In the previous VFO-A example of direct frequency entry, for example, we set up VFO-A on 7.255 MHz. Now press the [7] key momentarily. You will observe that “7.255.00” has disappeared, and another 7 MHz frequency (probably 7.000.00 MHz) is now displayed.

You may now retune this VFO register to any desired frequency. It may be desirable, for example, to set the new VFO register to 7.025 MHz CW, so you have one CW frequency and one SSB frequency in each band.

All settings of the frequency, mode, bandwidth, antenna selection, and antenna tuner adjustment are totally independent between the two registers on each band, so changing one VFO register’s bandwidth, for example, will have no effect on the alternate register’s settings.

Two VFO registers per band are also provided for VFO-B. Just remember to push and hold in the [GEN/CE] key for ½ second before pushing the [7] key to inspect and/or adjust the settings for the alternate 7 MHz register for VFO-B.

## Frequency Navigation

Once you have made an initial setting on a band (using the one-touch band keys or direct frequency entry), you may tune around the band in search of signals.

Several tuning methods are available, depending on which VFO is in use.

- For VFO-A frequencies:
  - VFO-A Tuning Dial
  - Shuttle Jog
  - Front Panel [UP/DOWN] Switches
  - Microphone [UP/DOWN] Switches
- For VFO-B frequencies:
  - VFO-B Tuning Dial

## VFO Tuning Dial

Rotating either VFO Tuning Dial tunes the transceiver according to the selected tuning step size. Due to the extremely fine steps synthesized by the Direct Digital Synthesis (DDS) circuitry, the tuning action is as smooth as though an analog tuning VFO were being used.

By pushing the [STEP] key, the tuning rate may be modified. The [STEP] key toggles between three settings: **FINE**⇒**NORMAL**⇒**FAST**⇒**FINE**. . .

The steps available in each mode are shown below.

MODE	STEP Switch		
	NORMAL	FAST	FINE
SSB, CW, DATA(SSB)	10Hz	100Hz	1Hz
AM, FM, DATA(FM)	100Hz	1kHz	10Hz

✎ The [STEP] switch affects the action of the VFO-A and VFO-B tuning dials, as well as the front panel and microphone [UP] and [Down] switches.

Finally, the number of tuning steps per revolution of the tuning dials may be changed via Menu Item U-01; see page 73 for details.

## Shuttle Jog (VFO-A)

The Shuttle Jog is an efficient way to achieve large frequency excursions, avoiding the need to spin the VFO-A tuning dial to move quickly from one frequency to another.

Basically, the Shuttle Jog is a spring-loaded ring used for frequency change. Rotating the Shuttle Jog ring away from its center detent in either direction will initiate tuning. The farther the Shuttle Jog ring is moved from the center, the larger and faster the amount of frequency change which results (minimum steps with slight rotation of the Shuttle Jog ring are 10 Hz).

## Front Panel Up/Down Switches

These switches may also be used for quick frequency excursions from one end of a band to another. In the “Normal” position of the [STEP] switch, for example, one touch of the [UP] switch will cause the frequency to jump upward by 100 kHz.

The frequency jumps available are shown at the right.

STEP SWITCH POSITION		
NORMAL	FAST	FINE
100kHz	1MHz	10kHz

## MH-31B8 Hand Mic Up/Dwn/Fst Switches

Pushing the MH-31B8’s UP or Dwn switch will initiate tuning in an upward or downward direction, in frequency steps set in accordance with the selection made via the [STEP] switch. Pushing the [Fst] key will switch tuning into the “Fast” mode, as though the front panel [STEP] switch had been set to “Fast.” See the table below for a summary of the steps available in these modes of operation.

MODE	UP	DWN	FST + UP	FST + DWN
SSB, CW, DATA(SSB)	·{10Hz	· 10Hz	·{100Hz	· 100Hz
AM, FM, DATA(FM)	·{100Hz	· 100Hz	·{1kHz	· 1kHz

## MD-100A8X Desk Microphone Rotary Scanning Switch

The (optional) MD-100A8X Desk Microphone features a Rotary Scanning Switch at the base of the microphone support stand. Rotating this switch to the left causes the frequency to scan lower, and rotating the switch to the right causes the frequency to scan higher. Rotating this switch *fully* to the left or right causes the scanning speed to switch to the “Fast” mode, as though you had pushed the [Fst] switch on the MH-31B8.

See the table below for a summary of the steps available in these modes of operation.

MODE	Right	Left	Fully Right	Fully Left
SSB, CW, DATA(SSB)	·{10Hz	· 10Hz	·{100Hz	· 100Hz
AM, FM, DATA(FM)	·{100Hz	· 100Hz	·{1kHz	· 1kHz

## Lock Switches

To guard against accidental changes in the settings of the Tuning Dials and/or the Shuttle Jog dial, use the Lock functions provided on the front panel.

The Lock switches to the lower right of the VFO-A and VFO-B Tuning Dials have slightly different effects, depending on how each switch is pressed. These switches may be used in combination to provide the desired locking control, as shown below.

	Lock (A) Switch	Lock(B) Switch
< 0.5 sec	VFO-A Tuning Dial and Shuttle Jog	VFO-B Tuning Dial
> 0.5 sec	None	All Switches exp. POWER, MOX, VOX Switches

# Operation

## Operating Convenience Features

### Display Brightness Control

The FT-920 is shipped from the factory with the display illumination set to its maximum level. Should you wish to reduce the illumination level of the display, use the following procedure.

- ① Press the [MENU] key to enter the Menu mode of operation.
- ② Rotate the VFO-B Tuning Dial to select Menu Item U-08 ("DIMMER").
- ③ Press the [ENT] key to enter the "Menu Command" mode.
- ④ Rotate the VFO-B Tuning Dial to change the setting indicated in the main display window from "OFF" to "ON."
- ⑤ Press the [MENU] key once more to exit the Menu mode and resume normal transceiver operation.

### Keypad Beep Frequency/Level

The "Beep" tone which is heard when you press a key on the front panel may be adjusted, if you like.

To adjust the Beep Frequency:

- ① Press the [MENU] key to enter the Menu mode of operation.
- ② Rotate the VFO-B Tuning Dial to select Menu Item U-06 ("BEEP-F").
- ③ Press the [ENT] key to enter the "Menu Command" mode. At this point, the current beep tone frequency will be heard.
- ④ Rotate the VFO-B Tuning Dial to set the tone that you prefer. Just for your information, the exact tone frequency will be shown on the main display window.
- ⑤ Once you have found a satisfactory tone, press [ENT] to exit the Menu mode and resume normal operation.

To set the Beep Level, you may adjust the Beep level potentiometer, which is accessible through a small adjustment hole on the bottom of the transceiver. Use a small insulated flat-blade alignment tool to set the level to the best amplitude for your operating needs.

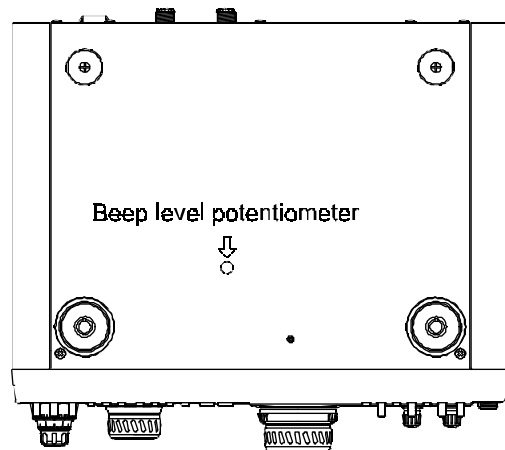

## Receiver Accessories

Noise, interference, changing signal characteristics, and changing propagation can all present difficult challenges to today's operator. The FT-920, however, provides a wealth of features designed to enhance reception on our crowded bands. These features are described below.

### Clarifier (Offset Tuning)

The Clarifier feature allows offset tuning from the current VFO frequency. The Clarifier provides several important capabilities:

- ❑ If the incoming signal begins to drift, the [RX CLAR] may be activated so as to allow you to continue receiving the other station *without* requiring you to adjust both your transmit and receive frequencies (possibly causing interference to other nearby operators).
- ❑ For DX pileup operation, the [TX CLAR] may be used to establish a split TX/RX frequency relationship, and the [RX CLAR] may be used to establish an optimum calling frequency.
- ❑ If you frequently need to move a fixed amount of frequency excursion (such as "five up"), the [TX/RX CLAR] control allows you to program this amount for instant recall and QSY to that frequency.

Press the [RX CLAR] key to activate the Receive Clarifier. The RX CLAR indicator will appear on the display, and the VFO-B Tuning Dial may now be used to move your receive frequency up to  $\pm 9.99$  kHz. If you want the transmit *and* receive frequencies to follow the programmed offset, also push the [TX CLAR] key.

The amount of offset from the VFO frequency will be displayed in the Multi-Function Window of the display, and a graphical representation of the magnitude and direction of the offset can be provided in the Enhanced Tuning Scale, with proper setup of Menu Item U-10 (see page 74).

To turn the Clarifier off, push the [RX CLAR] (and/or [TX CLAR]) again. The transceiver will revert to the original VFO frequency; however, the offset will not be wiped clean, but rather maintained at the current value on the assumption that you may want to hop back to the offset frequency again.

To set the Clarifier offset to *Zero*, press the [CLAR CLEAR] key.

### CW Center Tuning (Enhanced Tuning Scale)

The Enhanced Tuning Scale may be used to provide a visual indication of precise frequency adjustment in the CW mode. Configuration of the Enhanced Tuning Scale is performed via Menu Item U-10 (page 74).

When CW Center Tuning has been selected, the CW passband center frequency (as determined by the setting of the **PITCH** control) becomes the center point of the Enhanced Tuning Scale. Per the illustration below, when proper alignment of the incoming signal's pitch is accomplished, your *transmitter* signal will precisely align in a "zero beat" with the frequency of the incoming signal.

### CW SPOT

The CW Spot feature provides an *audible* method of aligning your FT-920's transmitter to the frequency of an incoming signal (as opposed to the *visual* method provided by the Enhanced Tuning Scale).

By pressing the **SPOT** key, you will activate a constant audio "sidetone" which is set to the pitch which matches (precisely) the pitch of your transmitted signal. The sidetone pitch frequency also corresponds to the center frequency of the receiver filter passband (with the **IF SHIFT** control centered in its default position). By aligning the CW Spot tone to match the pitch of an *incoming* station's signal, you will cause your signal and the other station's signal to be exactly on the same frequency.

The Spot tone's center frequency may be adjusted to any value between 300 Hz and 1050 Hz (in 50 Hz steps) by rotation of the **PITCH** control.

### RF Preamplifier Selections

Two RF preamplifier circuits are provided on the FT-920, each yielding particular benefits for the varying requirements throughout the operational range of this transceiver:

- ❑ A Junction FET (JFET) preamplifier includes high-Q selectivity for excellent protection from out-of-band energy.
- ❑ A Dual-Gate MOSFET preamplifier provides high gain and low noise figure, particular beneficial on the higher bands.

Via Menu Item U-47, you may assign these preamplifiers on a band-by-band basis; the default selec-

# Operation

tions are the JFET preamp on the 1.8 ~ 21 MHz bands, and the MOSFET preamp on the 24 ~ 50 MHz bands. We recommend that you use these settings initially, and only change them later if you have a particular need to do so.

⚡ Although the MOSFET preamplifier provides higher gain, the JFET preamplifier yields higher dynamic range with respect to out-of-band signals. Switching to the MOSFET preamp on 40 meters will, undoubtedly, provide a higher S-meter reading. However, the *useful* sensitivity will probably not change. On the other hand, when using a Beverage or small loop antenna for receiving on the low bands, the MOSFET preamp may be the better choice.

Remember: if you can hear background “band noise” appear when you connect your antenna, you already have adequate sensitivity. Any increase in front end gain beyond this point will not improve the signal-to-noise ratio on the incoming signal.

The preamplifier chosen will always be on, unless the [IPO] key is pushed. See the discussion of IPO operation below in the section regarding “*Tools for Strong-Signal and Low-Frequency Operation.*”

## **AGC** (Automatic Gain Control) Selection

The AGC system of the FT-920’s receiver prevents potential ear damage and/or overload of receiver components by establishing an “AGC Threshold” of signal input. Once the AGC Threshold is reached, further increase in signal strength does not result in an increase in audio output.

The recovery time of the AGC system (the time required for the receiver to recover to full sensitivity) is variable, and you may select the AGC recovery time which provides the most operator comfort.

To select the AGC recovery time, press the front panel’s [AGC] switch repeatedly. You will observe the display icons cycling through the available selections:

**AGC FAST** ⇒ **AGC SLOW** ⇒ **AGC OFF** ⇒ **AGC FAST** ⇒ . . .

The **AGC FAST** position is usually preferable for CW and SSB contest work, while you may prefer **AGC SLOW** for more casual voice work. **AGC OFF** is most often used for precise measurement of signals (when evaluating antenna patterns, etc.), but strong signals

will sound very distorted with the AGC turned off. Rotating the **RF GAIN** control counter-clockwise will help reduce the distortion.

## Squelch

If you wish to mute the FT-920’s receiver during no-signal conditions, rotate the **SQL** (Squelch) control clockwise until the background noise just disappears. This threshold point is the setting which produces the best sensitivity of the squelch to weak incoming signals.

When a signal is received which exceeds the threshold set by the **SQL** control the muting function will be disabled and normal receiver audio will flow. When the signal disappears, the receiver will again be muted.

The Squelch circuitry is most often used during FM operation, but the FT-920’s Squelch system is operational in all modes. It may be particularly useful while monitoring a 6-meter calling frequency (such as 50.125 MHz), or when waiting for a Mode-A (29 MHz downlink) satellite to come within range.

To disable the Squelch system’s muting capability, rotate the **SQL** control fully counter-clockwise.

## General Coverage Reception

You may have noticed that, if you tune outside of one of the 500 kHz segments which contains an Amateur band, the [GEN] icon on the display becomes illuminated. This indicates that the transceiver is now receiving in the “General Coverage” mode. On such frequencies, the transmitter is disabled. If you try to transmit, “**ERROR**” will appear on the display.

Since the FT-920 is chiefly an Amateur transceiver, the one-touch band keys do not recognize non-Amateur bands. However, you may use direct frequency entry to establish a starting point in, for example, a shortwave broadcast band; you may then use the tuning dial(s) and/or the **UP/DWN** switches to move around the band. You may also program a “favorite frequency” in each broadcast band into memory, then recall it quickly as a starting point for memory tuning. See the section on Memory operation, beginning on page 59, for details.

Otherwise, the FT-920’s receiver facilities completely support General Coverage reception, and you will



enjoy the many interesting aspects of shortwave listening. Among the transmission often encountered are:

**International Shortwave Broadcasts**  
(see table below)

**Maritime and Aeronautical Communications**  
(transoceanic airliners, etc.)

**News Services and Diplomatic/Embassy Traffic**

**Military Communications**

**WeatherFax Transmissions**  
(satellite images, charts, and forecasts)

Popular Shortwave Broadcast Bands			
Meter Band	Frequency Range (MHz)	Meter Band	Frequency Range (MHz)
LW	0.150~0.285	31	9.35~9.90
MW	0.520~1.625	25	11.55~12.05
120	2.30~2.50	22	13.60~13.90
90	3.20~3.40	19	15.10~15.70
75	3.90~4.00	16	17.55~17.90
60	4.75~5.20	-	18.90~19.30
49	5.85~6.20	13	21.45~21.85
41	7.10~7.50	11	25.67~26.10

## Dealing with Interference

### SHIFT Control

The front panel's **SHIFT** control tunes the position of the IF passband relative to the frequency of the incoming signal in all modes except FM. This allows the operator to sweep (in effect) the current IF filter back and forth across the desired signal, eliminating interference in the process, without changing the pitch of the incoming signal.

The control is detented in the center (12 o'clock) position, which represents the "normal" passband center frequency. The **SHIFT** control is dedicated to the receive mode, and does not affect your transmitted signal characteristics (such adjustment of the transmitted signal is, however, provided via Menu Items U-59, U-60, U-62, and U-63).

Rotate the **SHIFT** control to the left or right to eliminate the interference. Careful adjustment of the **SHIFT** control may also be useful in improving the recovered audio on excessively bassy SSB signals. Return the **SHIFT** control to the center detented position to return to the normal default passband setting.

### HIGH CUT/LOW CUT Controls (DSP)

The DSP system's chief interference-fighting circuitry is the passband tuning feature, which features the **HIGH CUT** and **LOW CUT** controls. These controls may be used to optimize the audio bandwidth so as to reduce interference and noise, and maximize signal-to-noise ratio.

To activate the DSP passband filter, press the **[DSP]** key (located just below the **SHIFT** control). The **[DSP]** key contains an LED, which will glow green when the DSP is on. Now rotate the **HIGH CUT** and **LOW CUT** to roll off interference and/or noise, or to enhance the sound of the incoming signal. A graphical representation of the relative width of the DSP passband can be displayed on the Enhanced Tuning Scale by making the appropriate configuration of Menu Item U-10. See page 74 for details.

Press the **[DSP]** switch again to turn the DSP passband filter off.

Note: Since the DSP passband filter operates in the audio section, after the AGC detector, very strong signals inside the IF passband but outside the DSP

# Operation

passband may cause interference to reception by “pumping” the AGC, causing the desired signal to fade in and out rapidly. Engage the Narrow CW filter, if installed, or use the **SHIFT** control, to roll off the offending signal before it reaches the DSP stage.

## Notch Filter (DSP)

Unwanted beat notes inside the RX filter passband can be effectively removed by utilization of the DSP Notch function. The DSP system will detect the beat note, then automatically center a sharp notch filter to eliminate the beat note. If multiple beat notes are present the DSP will create multiple notch filters to eliminate them!

To activate the DSP Notch Filter, press the [**Notch**] key. To turn the filter off, press the [**Notch**] key once more.

Note: The DSP Notch filter should not be used in the CW mode! The DSP system will interpret a CW carrier as being “interference,” and will notch out the incoming signal. Therefore, as you tune the band with the Notch Filter on, CW signals will appear for a moment, then disappear as they are notched out.

## RF GAIN Control

The **RF GAIN** control is a highly useful interference-fighting control that is often overlooked.

When interference or background noise are severe, rotating the **RF GAIN** control counter-clockwise may, in some instances, improve reception. Counter-clockwise rotation of the **RF GAIN** control reduces the gain in the RF and IF stages by applying an increasing amount of AGC voltage; this causes the background noise and signal levels to decrease, and it also causes the “no-signal” indication of the S-meter to rise. Signals *weaker* than the minimum S-meter indication may still be plainly audible, but they will no longer be affecting the AGC system.

This may be exploited by the skillful operator, particularly with regard to the DSP system. Because the DSP operates in the audio section of the receiver, after AGC detection is accomplished, rotating the **RF GAIN** control counter-clockwise may reduce the detrimental effects of strong noise and interfering signals, and may render the DSP more effective at eliminating beat notes, adjacent-frequency interference, or noise. To do this, reduce the setting of the **RF GAIN**

control until the S-meter hangs up approximately at the peak signal level of the interfering signal; this places the incoming signals *below* the AGC Threshold (described on page 42). Now engage or adjust the necessary DSP features, and you will, in many circumstances, find that interference rejection is improved.

For maximum sensitivity, the **RF GAIN** control should be set fully clockwise.

## IF Noise Blanker (NB)

When automotive ignition noise, power-line noise, or other impulse-type noise is present, the IF Noise Blanker feature may be engaged so as to minimize or eliminate the noise.

Press the [**NB**] switch so as to illuminate the **NB** icon on the display, then rotate the **NB LEVEL** control to the point of maximum noise elimination consistent with the maintenance of good signal quality. Press the [**NB**] switch again to turn off the IF Noise Blanker.

Note: Under extremely strong signal conditions on a crowded band, such as during a DX contest, etc., excessive advancement of the **NB LEVEL** control may cause somewhat degraded immunity from “splatter” from very strong nearby stations. This general tendency is typical of all IF noise blanker circuits, and the FT-920’s circuitry is carefully designed to minimize this characteristic. Try reducing the setting of the **NB LEVEL** control if this is observed, and try to utilize the DSP Noise Reduction to compensate (see below).

## DSP Noise Reduction (NR)

The DSP system of your FT-920 includes a highly-effective Noise Reduction circuit. The DSP Noise Reduction is particularly helpful in enhancing signal-to-noise ratio by lowering the overall level of background noise. The DSP Noise Reduction works to improve on the action of the IF Noise Blanker by eliminating lower-level, non-impulse-type noises that are difficult for the IF Noise Blanker to detect.

To activate the DSP Noise Reduction, rotate the **NR** control clockwise from its default position, which is fully to the left. Adjust the setting of the **NR** control until the best signal-to-noise ratio is achieved. Also try adjusting the setting of the **RF GAIN**, per the discussion previously, to see if reducing the RF/IF gain

level will enhance the performance of the DSP Noise Reduction.

To turn the DSP Noise Reduction off, rotate the **NR** control fully counter-clockwise.

✍ As you tune around the band while using the NR circuit, you may discover that the apparent “pitch” of the background noise changes somewhat after you encounter signals. The NR circuit is an adaptive filter which “form fits” around a signal, so this observation is completely normal.

## *Tools for Strong-Signal and Low-Frequency Operation*

Operation on the lower HF Amateur bands (160 through 30 meters) presents special challenges, including high atmospheric noise levels, strong local signals, and a lack of antenna directivity (compared with higher-frequency multielement beam antennas). The FT-920 is particularly well equipped to assist the operator in maintaining reliable communications under these difficult conditions.

The receiver section front end includes a high-intercept doubly-balanced mixer, which provides excellent immunity from intermodulation. For protection against the ingress of out-of-band signals which can cause intermodulation, the receiver front end is protected by a bank of bandpass filters, including special high-Q filters for the 7, 14, 21, and 50 MHz bands. And the built-in Automatic Antenna Tuner may be engaged on receive, as well as transmit, providing extra protection against strong signals outside the current band of interest.

Other features of interest to the operator in strong-signal environments include:

### *IPO (Intercept Point Optimization)*

The IPO feature reduces the receiver front-end gain by bypassing the RF preamplifier. When the extra gain of the preamp is not needed (typically below about 10 MHz), engaging the IPO feature will reduce the background noise level and improve the receiver’s immunity by reducing the signal level presented to the first mixer. So long as background “band noise” is still audible, the *useful* sensitivity of the receiver will not have been reduced by activating the IPO.

To turn this feature on, press the [**IPO**] key, located just to the right of the [**METER SELECT**] key on the left side of the front panel. The **IPO** icon on the display will become illuminated, and the background noise level should drop. If you have reduced the setting of the **RF GAIN** control previously, you may need to rotate it clockwise somewhat after turning on the IPO feature.

To re-activate the receiver front end’s preamplifier again, press the [**IPO**] key again.

# Operation

---

## ATT (Front End Attenuator)

Under conditions of extremely high signal levels, the front end attenuator may be engaged, either singly or in conjunction with the IPO feature, to reduce receiver sensitivity.

Pressing the front panel's [ATT] key repeatedly causes the attenuator to cycle through the various levels of attenuation provided (in 1 S-Unit steps of 6 dB each):

**6 dB ⇒ 12 dB ⇒ 18 dB ⇒ 0 dB ⇒ 6 dB ⇒ . . .**

The "0 dB" position, of course, represents the "Attenuator Off" configuration.

## Digital Voice Recorder Operation (DVR)

The FT-920 includes a built-in Digital Voice Recorder which you can use to record and then replay the incoming signal (from the VFO-A path) for a period of up to 16 seconds. In addition, the DVR may be used for storage and replay of repetitive ("CQ" type) messages in *your* voice. See the section on "Transmission" (page 50) for details of the latter feature.

Recording and playback of incoming signals is straightforward.

- ① While receiving, press the [REc] switch, then [0] (50 MHz), to start recording. The recording level is set automatically, so you may leave the listening volume at a level which is comfortable for you. During recording, the *hyphen* in the Memory Channel display field will blink.
- ② To stop recording, press the [REc] switch momentarily again. The last 16 seconds of incoming audio will now be stored. In this way, you can quickly confirm, for example, if a DX station correctly copied your callsign through a pile-up.
- ③ To play back the stored audio, press [PLAY] then [0] (50 MHz). For playback, the front panel's [AF GAIN] control sets the volume level. Incoming signals, however, will be cut off for the duration of the audio memory playback.

## Transmitting

Now that you are familiar with receiver operation, we shall explore the FT-920's capabilities in the transmit mode.

### Important Note!

*Whenever you transmit, be certain to have a suitable antenna or 50  $\Omega$  dummy load connected to the antenna jack in use. Although the FT-920's final amplifier protection circuitry will drastically reduce power if no load is present, there still is a slight chance of damage to your equipment in the unlikely event of a catastrophic protection-circuitry failure.*

The transmitter can be activated within an amateur bands. When tuned to any other frequency, the transmitter will be disabled. You, as the station control operator, are responsible to restrict your transmissions to those frequencies on which you are authorized to operate.

Attempting to transmit outside of an amateur band segment will cause the "ERROR" diagnostic message to appear on the display.

Whenever the transmitter is activated, the FT-920's built-in directional coupler detects any reflected power which appears at the final amplifier's output port (due to antenna system impedance mismatch), and disables the transmitter if too much reflected power is found (in which case the [Hi SWR] icon will become illuminated). You should cease transmission immediately, and determine the cause of the antenna system fault.

✎ The upper limit of the transmitter's power output can be set via Menu Items U-49 (for Antenna A) and U-50 (for Antenna B) separately for each antenna port. See page 79 for details.

## Automatic Antenna Matching

The built-in automatic antenna tuner unit is capable of matching antenna systems presenting impedances within the range 16.5–150  $\Omega$ , which corresponds to a maximum SWR or approximately 3:1. If the antenna(s) you are using exceed this SWR as configured, you must make adjustments (electrical and/or mechanical) so as to present an impedance closer to 50  $\Omega$  to the FT-920's ANTENNA jack(s). Remember that the net SWR as detected by the FT-920 may be different than the SWR at the antenna feedpoint, depending on the degree of impedance transformation which may occur in your feedline (if the feedpoint impedance is not very close to the coaxial cable's 50  $\Omega$  impedance).

Note that the FT-920's automatic antenna tuner is not designed to cope with the wide variations in impedance presented by a random-length long wire antenna, unless you take specific steps to match the impedance at all frequencies of interest.

To use the FT-920's automatic antenna tuner:

- ① Turn the **RF PWR** control fully clockwise (the transceiver will automatically reduce its power to a maximum of 50 Watts during antenna tuning).
- ② Check to be certain that the frequency is clear before initiating antenna tuning.
- ③ Press and hold in the **TUNER** switch for ½ second to activate the tuner. The **RX TUNER TX** indicator will appear on the display.
- ④ A carrier will now be transmitted by the FT-920. The automatic antenna tuner will now adjust itself so as to present a low SWR to the final amplifier stage. The "**WAIT**" indicator will appear on the display during tuning.
- ⑤ When tuning is completed, the "**WAIT**" indicator will disappear, and the FT-920 will revert to the receive mode. At this point, if the tuner achieved an SWR of less than 1.5:1, the tuner settings will be stored by the tuner's memory system; these settings will be used the next time operation takes place on this frequency. If the tuner was not able to achieve an SWR of 1.5:1 or lower (typically only when the "Tuner-Off" SWR is above 3:1), the tuner's memory system will ignore these settings, and the tuning procedure should be repeated the next time

# Operation

you operate on this frequency; this feature prevents you from storing an undesirable setting (such as that produced when you accidentally select the wrong antenna on a particular band).

- ⑥ Should you wish to take the antenna tuner out of line, press the **TUNER** switch momentarily. The **RX TUNER TX** indication will disappear from the display.

## How the Automatic Antenna Tuner Works

When the **TUNER** switch is pressed and the **RX TUNER TX** indicator is displayed, the following operations take place:

- A. The tuner's microprocessor reviews the current the tuning conditions (if any) stored in memory, and applies the settings for the frequency closest to the current frequency as a starting point for operation. Note that a change in tuning conditions is produced for every change in operating frequency of approximately 10 kHz.
- B. If transmission occurs (without the operator pressing the **TUNER** key), the tuner will begin adjustments if the SWR is found to be 3:1 or greater. Tuner settings will not be recorded in this instance. If, however, the **TUNER** key is pushed and held in for ½ second, the tuner settings *will* be stored in the tuner's memory system.
- C. If tuning is successfully accomplished, and the tuner settings stored into memory, the antenna system characteristics as seen from the transmitter's perspective resemble curve (1) in the graph below. If you QSY to frequency (2) in the chart (where the SWR is above 3:1), the tuner will be automatically activated when you begin to transmit.
- D. The automatic antenna tuner has 100 dedicated tuner memory registers, of which eleven are allocated (one each) to the amateur bands covered by the FT-920. The other 89 record the most recent tuner settings, irrespective of the band in use, on a first-in, first-out basis.
- E. The automatic antenna tuner is configured at the factory to be engaged both on receive *and* transmit. It is possible, however, to configure it so that the tuner is only active on transmit. See Menu Item U-48, described on page 79.
- F. The automatic antenna tuner only adjusts the *apparent* SWR as presented to the transceiver. No adjustments made by the tuner can, of course, affect the SWR present on the coaxial feedline. Therefore, every effort should be made to minimize SWR so as to ensure efficient power transfer to the antenna feedpoint (since feedline losses may escalate rapidly as SWR increases).
- G. Because the impedance of such antennas varies widely depending on the band in use, please note that random-length long-wire and center-fed flat-top antenna systems generally will not be satisfactorily tuned by the FT-920's automatic antenna tuner unless you make design provisions for ensuring that the impedance stays within the specified range of 16.5 ~ 150 Ω.

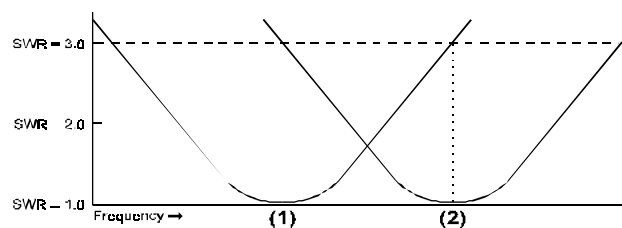

## SSB Transmission

### Basic Operation

- ① Connect your microphone to the front panel **Mic** jack.
- ② Preset the front panel controls as follows:
  - MODE**; **LSB** or **USB** (depending on band; use USB on 14 MHz & higher bands)
  - METER SELECT**; **ALC**
  - Mic GAIN**; 9 o'clock position
  - RF PWR**; Fully clockwise
- ③ Press the microphone's **PTT** switch, and speak into the microphone at a normal voice level. The **TRANSMIT** indicator in the display will be illuminated, and the ALC meter will deflect according to the peaks in your speech. Adjust the **Mic GAIN** control so that the ALC meter peak reading is along (but not beyond) the right edge of the ALC range on the meter.

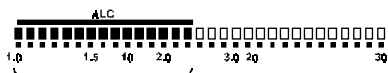

- ④ Release the **PTT** switch to return to the receive mode.
- ⑤ For operation at lower power levels, rotate the **RF PWR** control counterclockwise while watching the **PO** scale on the meter so as to set the desired power level.
- ✂ Counterclockwise rotation of the **RF PWR** control, or operation using an antenna with an impedance greatly different from 50 Ω, may result in a higher reading on the ALC meter. Therefore, it is helpful to make initial adjustment of the **Mic GAIN** control into a 50 Ω dummy load or carefully-matched antenna, and with the **RF PWR** control fully clockwise.

### VOX Operation

When operating in the SSB, AM, or FM modes, you may use the VOX system to provide hands-free automatic change-over from receive to transmit. When the speech input from the microphone is detected by the VOX circuitry, an internal "PTT" switch will be activated to begin transmission; when speech input ceases, the VOX circuitry will release the transceiver back to the receive mode. Operation is quite simple:

- ① Press the **VOX** switch.
- ② Without pressing the **PTT** switch on the micro-

phone, speak into the microphone at a normal voice level. The FT-920 should automatically switch into the transmit mode, and should return to receive when you quit talking.

- ③ To cancel VOX and return to PTT operation, press the **VOX** switch once more.

The VOX system may require minor adjustment to optimize its parameters for your particular voice characteristics. These parameters are set via the Menu system as follows:

- If speaking in your normal voice level does not activate the transmitter, or if background noise in the operating room trips the VOX, the VOX sensitivity (**Vox GAIN**) may be adjusted via Menu Item U-65, as described on page 81.
- If the delay in returning to the receive mode is not suitable for your operating habits (too quick or too slow), the delay interval (**Vox DELAY**) may be adjusted via Menu Item U-64, as described on page 81.
- To prevent the speaker audio from activating the VOX circuitry, you may need to adjust the VOX Antitrip setting. Use Menu Item U-66, described on page 82, to do this.

### Digital Speech Processor Operation

The Digital Speech Processor provides two chief methods of enhancing your SSB "talk power:"

- Using digital audio compression methods, the Digital Speech Processor increases your transceiver's *average power output*; and
- Using specially-designed digital equalization techniques, you may choose a DSP voice pattern contour which most closely matches your voice's characteristics, so as to focus more of the *available transmitter power* into transmission of the most useful frequency components of your speech. Four different voice pattern contours are available.

Once you have correctly set the **Mic GAIN** control's level, you may set up the Digital Speech Processor as follows:

- ① Press the **METER SELECT** switch so that the transmitter selection is set to **COMP**.
- ② Press the **PROC** switch once so that the **PROC** indicator on the display becomes illuminated.
- ③ Press the **PTT** switch, and speak into the microphone in a normal voice level. You will observe

# Operation

the **COMP** meter indication fluctuating according to your speech input. Now adjust the front panel's **PROC LEVEL** control so that the reading on the **COMP** scale peaks at or below 10 dB.

- ④ To deactivate the Digital Speech Processor, press the **PROC** switch once more. The **PROC** indicator on the display will disappear.
- ✍ Raising the compression level generally raises talk power; however, excessive advancement of the **PROC LEVEL** control will cause the signal-to-noise ratio on your speech signal to deteriorate, thus reducing the effectiveness of the speech processor. Keeping the compression level below 10 dB will ensure that this does not occur.

## DSP Voice Pattern Contours

If you wish to enhance the effectiveness of your speech processing system, you may choose from one of four voice pattern contours which are provided via Menu Item U-51. See page 80.

**OFF:** DSP microphone equalization is disable.

- 1: Mid- and high-frequency components are enhanced .
- 2: A high-emphasis response is produced, ideal for pile-up or contest work.
- 3: Both low- and high-emphasis response are produced.
- 4: A wide bandpass response is produced, emulating a "Broadcast" microphone audio characteristic.

Once you have selected the desired voice pattern contour, press the **DSP** switch to activate the Digital Signal Processing (DSP) system. No further adjustment should be necessary.

- ✍ The Voice Pattern Contour feature may be used alone, or in conjunction with the Digital Speech Processor. Experiment with these systems singly and in combination to determine which setting provides the best talk power and audio quality in relation to your voice's characteristics.

## Voice Monitor Operation

The Monitor function allows you to observe the characteristics of your speech signal so as to make adjustments of the DSP, AM or FM modulation characteristics, etc.

- ① Press the **MONI** switch to activate the Voice Monitor; the **MONI** indicator on the display will become illuminated. Now, when you speak, your voice will

be audible from the speaker or headphones.

- ② Adjust the Monitor's volume by rotating the **MONI LEVEL** control. Clockwise rotation increases the volume level from the Monitor.
- ③ Press the **MONI** switch again to turn the Monitor off.

## Digital Voice Recorder Operation (Transmit)

The FT-920's Digital Voice Recorder can be used to store as many as four messages, in your own voice, of up to 16 seconds in length. Such messages may be used for repetitive "CQ" calling for contest work; you might also use the Digital Voice Recorder to store your callsign phonetically, then send it automatically in a pile-up situation late at night when you don't wish to awaken other family members (you can also store "Roger, roger, five nine, fifty-nine" plus your callsign to complete the contact).

Operation is similar to that described for receive-mode recording (see page 46), except that the **[REC]** and **[PLAY]** keys are pressed *and held in for ½ second* to accomplish the desired action (on receive, these switches are pressed *momentarily*).

The four message locations are designated by the **[1] ~ [4] BAND** keys.

- ① Press and hold in the **[REC]** key for ½ second, then press the **[1]** key on the keypad to begin recording in DVR memory #1.
- ② Speak into the microphone in a steady voice level. The recording volume level is set automatically, so the **Mic GAIN** control has no effect during DVR recording.
- ③ Press the **[1]** key again to stop recording, if you elect not to use the full 16 seconds available.
- ④ Repeat this process for any of message locations **[2] ~ [4]** into which you wish to store a message.
- ⑤ To review the message without transmitting it, press and hold in the **[MONI]** key for ½ second. The replay volume may be adjusted using the **AF GAIN** control.
- ⑥ To transmit the stored message over the air, press and hold in the **[PLAY]** key for ½ second, followed immediately by the appropriate **BAND** key. The PTT circuitry will automatically engage, switching the FT-920 into the transmit mode, and the transceiver will return to receive at the completion of the message.



The input level of your voice signal to the Digital Voice Recorder may be adjusted by using the **Mic GAIN** control. The optimum settings for the Recorder may, however, be slightly different from those used in normal operation; this is normal.

## CW Transmission

The FT-920's versatile design allows the CW operator unparalleled flexibility for operation using the internal electronic keyer, an external keyer, a computer-driven keying interface, or a straight key.

The best selections for interconnections and switch positioning will depend critically on your application. See the configuration details beginning on page 18 for suggestions.

### Straight Key Operation

- ① Insert your key's plug into either **KEY** jack. Set the other controls as follows:

**MODE**; CW

**KEYER**; Off (No icon should appear on display).

**RF POWER**; Fully clockwise.

**SIDE TONE**; 12 o'clock position.

**VOX**; Off

**BK-IN**; Off

**PDL-KEY**; Confirm that

this rear panel switch is set to **KEY**.

If you close the key at this point, you will hear the CW side tone in the background, but you will not be transmitting. This mode allows you to adjust the **SIDE TONE** control for a comfortable volume level, and it is also useful if you wish to practice sending.

- ② For "Semi-Break-In" operation, press the **VOX** switch. Now, when you press on the key, the transmitter will automatically activate, and after you quit sending the FT-920 will return to the receive mode. The "Hang Time" for the CW "VOX" circuitry is adjustable (separately for the CW mode as opposed to SSB) via Menu Item U-24. See page 76.
- ③ For "Full Break-In" ("QSK") operation, turn the **VOX** off and press the **BK-IN** switch. Now, pressing and releasing the key will cause instantaneous TX/RX switching in tandem with your keying, allowing you to hear any incoming signals in the spaces between dots, dashes, and letters in your sending. This may be particularly helpful for message handling or contest operation.
  - ✍ When the **VOX** is *on*, pressing the **BK-IN** switch does *not* cause QSK operation to be activated, as the **VOX** command will *override* the *Break-In* command. When both switches are pressed so these features are both on, the FT-920 will

# Operation

remain in the Semi-Break-In mode.

- ④ For low-power operation, rotate the **RF PWR** control counter-clockwise until the desired power output is observed on the transmitter meter.

## Electronic Keyer Operation

The built-in Electronic Keyer may be used alone, or in combination with an external keying device such as a computer-driven keying interface.

- ① Connect your keyer paddle's cable to the front panel's **KEY** jack. If you wish to use the rear panel **KEY** jack, connect the paddle's cable to that jack, and set the rear panel's **PDL-KEY** switch to **PDL**.
- ② Confirm that the controls and switches are set up as they were originally for Straight Key operation on the previous page.
- ③ Press the **KEYER** switch to turn the electronic keyer on. The **KEYER** indicator will appear on the display.
- ④ Close the "Dot" contact on the paddle, and rotate the **KEYER SPEED** control to set the electronic keyer's speed to the desired level. Clockwise rotation increases the sending speed.
- ⑤ Adjust the sidetone to a comfortable level by rotating the **SIDE TONE** control.
- ⑥ Select Semi-Break-In or Full Break-In, as desired, as you did during Straight Key operation.
- ⑦ The weight (proportion of dots to dashes) may be adjusted (each parameter individually) in the event you wish to modify the relationship from the default 1:1:3 Dot:Space:Dash ratio. Use Menu Items U-21 and U-22 (see pages 75 and 76).

### Default 1:1:3 Dot:Space:Dash

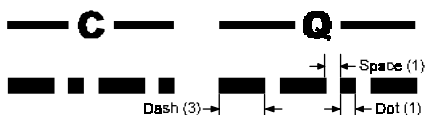

### 1.5:1:3 Dot:Space:Dash

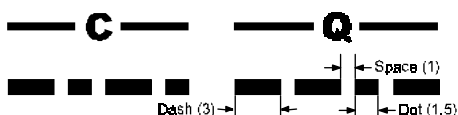

### 1:1:4.5 Dot:Space:Dash

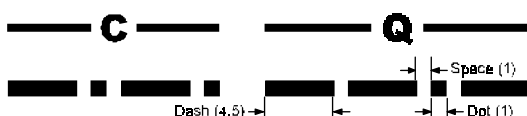

- ⑧ A programmable delay in the keyer transmission may be added, when using an amplifier, so as to allow the amplifier's relays a few extra milliseconds in order to become properly seated. This delay shifts the entire stream of dots and dashes without changing the weight. Use Menu Item U-23 (see page 76).
- ⑨ The function of the electronic keyer may be changed from "Keyer Without Space" to "Keyer With Auto-Space" to "Bug Keying" via Menu Item U-20 (see page 75).

## Memory Keyer Operation

The FT-920 includes an easy-to-use CW Message memory system, which allows automated CW sending of repetitive messages (such as "CQ TEST" or "CQ DX" etc.). The following functions are available through the CW Message Memory system:

- Up to six messages may be stored (four may contain up to 50 characters, while the other two may contain up to 20 characters).
- A sequential contest number (001, 002, . . .) may be imbedded in a message, if desired.
- The stored messages may be reviewed *without transmission* so the contents may be checked for accuracy.
- The message(s) may be transmitted so as to reduce operator fatigue during long operating sessions, such as in a contest.

## Message Memory Storage

- ① Press the **[REC]** switch, then one of the keypad keys numbered **[1] ~ [4]**, **[8]**, or **[9]** to store a message in one of those slots. Memories **[1] ~ [4]** will accommodate messages of up to 50 characters in length, while Memories **[8]** and **[9]** will accommodate messages of up to 20 characters in length. Additionally, Memory **[9]** can accommodate a message within which a sequential contest number may be imbedded.
- ② After pressing one of the numbered keys, start sending the desired message (e.g. "CQ TEST JA1YOE JA1YOE K"). The storage process will be terminated automatically.
- ③ To imbed a contest serial number in a message, send three *Question Marks* at the desired point in a message assigned to the **[9]** key. For example, to send "599001," "599002," and so forth, store "5NN???" into the special "Contest Number

Memory Register (Key #[9]). If the number gets out of sequence during the contest, you may set the number to an arbitrary value via Menu Item U-25.

### *Review of Stored Messages*

To review messages previously stored *without sending them over the air*, press and hold in the [PLAY] switch for ½ second, then press the desired number key on the keypad. You will hear the message via the Sidetone circuit, so as to check it for accuracy.

### *Transmission of Stored Messages*

Press the [PLAY] switch momentarily, then one of the number keys [1] ~ [4], [8], or [9] to play the message stored in that memory register. The transmitter will automatically be activated for message generation, after which the transceiver will automatically revert to the receive mode.

✍ The CW Message Memory, and electronic keyer, only function in the CW mode. If you wish to practice sending, or check message memory contents, be certain to select the CW mode of operation.

## *Split Frequency Operation*

DX operators frequently have need for split frequency operation, whereby a DX-pedition station may transmit on one frequency while listening over a segment of the same band. The FT-920 provides several means of efficient split frequency operations for DX operation and even certain satellite operating situations.

### *TX CLARifier Operation*

For splits of up to ±9.99 kHz, the TX Clarifier provides a simple means of split operation.

### **Example:**

*DX1DX is transmitting on 14.024.0 MHz, listening "Up 5" kHz:*

- ① With the Clarifier set to zero offset, tune in DX1DX on 14.024.00 MHz using the Main VFO Tuning Dial.
- ② Press the **TX CLAR** button, and rotate the Sub VFO Tuning Dial so as to set up a Clarifier offset of -5.00 kHz.
- ③ Push the **RX CLAR** button, and you will now be listening in the area of 14.029.0 MHz. You may hear a number of stations calling, and you *may* hear this station currently being worked by DX1DX.
- ④ If you can hear the station being worked by DX1DX, press the **SPOT** key, and adjust the VFO-B Tuning Dial so as to align the pitch of the station being worked by DX1DX with the pitch of your radio's **SPOT** tone; this action will place you exactly on the frequency currently being received by DX1DX.
- ⑤ Now press the **RX CLAR** key again to turn off the Receive Clarifier. You will now be back on 14.024.00 MHz, listening for DX1DX to send "QRZ?" When you transmit, you will be approximately on 14.029 MHz, depending on how far you adjusted the offset so as to zero in on the station being worked by DX1DX.
- ⑥ If you don't work DX1DX after one or two calls, again press the **RX CLAR** key and look around for the station being worked by DX1DX; then press **RX CLAR** again to return to 14.024.00 MHz for receiving DX1DX.

# Operation

## Split VFO Operation

Some pile-ups (especially on SSB) involve a split greater than  $\pm 9.99$  kHz. In these cases, use the two VFOs on the FT-920 for split frequency operation.

### **Example:**

*DX1DX is on 7.095.0 MHz, listening "210 to 220" (7.210 ~ 7.220 MHz) for replies:*

- ① With the Clarifier(s) off, and TX/RX control on the Main Tuning Dial, tune in DX1DX on 7.095.0 MHz.
- ② Press and hold in the [A ▶ B] key for ½ second, then rotate the VFO-B Tuning Dial to set VFO-B somewhere between 7.210 and 7.220 MHz (pressing [A ▶ B] ensures that both VFOs are on the same operating mode).
- ③ Press the VFO-B [TX] indicator, which will glow Orange after you press it. This indicates that VFO-A is in charge of the receive frequency, while VFO-B is controlling the transmit frequency.
- ④ In the same manner as you did in the **TX CLAR** example previously, you may press the VFO-B [RX] indicator so as to listen to the pile-up. If you find the station being worked by DX1DX, tune quickly onto that station's frequency, then press the VFO-A [RX] indicator to return receive frequency control to VFO-A, so you can listen for DX1DX to say "QRZ?"

⚠ When operating Split via any means, in pile-up situations be absolutely certain not to press the VFO-A [TX] indicator accidentally, as this will make you transmit on the DX station's frequency, causing interference to others trying to work the DX.

## Quick Split Feature

A user-programmed "Quick Split" may be utilized to provide a starting point for split operation. For example, if many of your DX pile-up operating situations require you to transmit 5 kHz higher than you are receiving, this feature may be useful to you. Here is the procedure for activating Quick Split:

- ① Press the [MENU] key to enter the Menu mode.
- ② Rotate the VFO-B Tuning Dial so as to select Menu Item U-04.
- ③ Press the [ENT] key to enter the Menu Command mode.
- ④ Now rotate the VFO-B Tuning Dial to select "5.0" (kHz) or whatever Tx/Rx split you desire.

- ⑤ Press the [MENU] key once more to exit the Menu mode.
- ⑥ While operating with both Tx and Rx control from VFO-A, press the [A ▶ B] key. You will observe that Tx control has been shifted to VFO-B, and that VFO-B's frequency is 5 kHz higher than VFO-A's.
- ⑦ To *cancel* Quick Split, repeat the first four steps above; in step ④, rotate the VFO-B Tuning Dial to "OFF" then press [MENU] to exit the Menu mode and resume normal operation.

## Mode K Satellite Operation

Although the FT-920 is not designed for full duplex satellite operation, Mode K satellite operation (uplink on 21.2 MHz, downlink on 29.4 MHz) is nonetheless possible, particularly on CW. Here is a generalized example of such an operating scenario; consult one of the many satellite operating journals for precise frequency information:

- ① Set VFO-A to 29.430 MHz, CW mode, and disable (temporarily, at least) the Narrow filter, if currently on. Be sure that the VFO-A [RX] indicator is illuminated.
- ② Set VFO-B to 21.230 kHz, CW mode. Press the VFO-B [TX] key so that the switch/LED glows Orange.
- ③ If you are using a typical triband or log-periodic antenna which covers both 15 and 10 meters, set up the two VFOs for operation on the same antenna. If you are using separate antennas on the two bands, connect the 15 meter antenna to antenna port B, and select Antenna B for VFO-B; now connect the 10 meter antenna to antenna port A, and select antenna A for VFO-A.
- ④ Press the [BK-IN] switch to activate full CW break-in operation.
- ⑤ If the appropriate satellite is above the horizon, and the frequency is clear, you may now send a string of dots to allow you to find your downlink signal through the satellite. Because the break-in system allows you to listen between dots, the propagation delay through the satellite should allow you to hear traces of your signal, and you may adjust the appropriate VFO for the exact pitch desired, as well as to follow Doppler shift.
- ⑥ Make a note of the TX/RX frequency differ-

ence by pressing the [DSPLY] key. You may use this display option to use the current offset as a starting point for setting the VFO-A/VFO-B relationship when tuning around the satellite transponder downlink segment. Remember, though, that Doppler shift will change during an operating session, so the initial offset will not be maintained indefinitely.

✍ The function of the [DSPLY] key must be set to [OFFSET], via Menu Item U-09, for this function to work. See page 74.

- ⑦ For SSB operation, be certain that each VFO is set to the correct sideband. Initially during a pass, it may be easier to establish the Uplink/Downlink frequency offset on CW, then switch both VFOs back to SSB.

✋ When operating on Mode K, take particular care to check your uplink frequency before transmitting, as your signal may be propagated over a long distance on the 21 MHz band, possibly causing harmful interference to other operators.

## Digital Mode Operation

The FT-920 provides outstanding capabilities for digital mode operation, such as RTTY, packet, etc.

It is important that you understand the differences between the two keying methods provided on the FT-920 for digital mode operation, so that the controls and switches may be set correctly.

- ❑ Most operation is accomplished using **Audio Frequency-Shifted Keying (AFSK)**, whereby the Terminal Node Controller (TNC) generates *audio* tones to be transmitted as data by the FT-920. To activate this mode of operation, the front panel Mode selection must be set to **DATA-USB** (even though “**USB**” may not be the actual sideband utilized in operation), and the rear panel **AFSK-FSK** switch must be set to **AFSK**.
- ❑ The FT-920 can also accept input from a TNC or Terminal Unit (TU) operating in the FSK (**Frequency-Shifted Keying**) mode, whereby a *closure to ground* of the FSK keying line causes the transmitted carrier to be shifted in frequency; no audio tones are produced by the TNC or TU.

### AFSK RTTY or Packet Operation

The AFSK configuration environment may be the easiest for you to use, as the TNC then has total control of the tone frequencies, Mark/Space relationship (normal/inverted), and other aspects of digital operation which are critical to successful operation.

- ① Connect your TNC to the FT-920's **DATA** jack per the instructions on page 16. Pin 1 of the **DATA** jack should be connected to the TNC's “**Mic AUDIO**” or “**Tx AUDIO**” line. Be sure to set the **AFSK-FSK** switch to **AFSK**.
- ② For AFSK RTTY (Baudot) or 300 bps HF Packet operation, press the [DATA] mode key until “**DATA**” and “**USB**” appear on the display. Now enter the Menu system, and select Menu # U-46; set this Menu Item for the frequency appropriate for your operating mode:
  - ❑ For typical RTTY operation, select **2125-L**; this sets the carrier injection up for an offset of 2.125 kHz in a pseudo-LSB mode, so that the transceiver actually is operating in the “**LSB**” mode (even though the display still indicates **DATA-USB**).

- ❑ For Packet operation, you may leave Menu # U-46 in its default **2125-U** (pseudo-USB mode), or set it to **1700-U** or some other value as required by the configuration of your TNC. See the documentation provided with your TNC's communication software for details regarding defining the transmitted tones.
- ③ The packet frequency display (offset) may also be modified via Menu # U-45, allowing you to have the radio's display indicate either Mark or Space frequency, or the center frequency of the two tones.
- ④ At this point, you are ready to utilize your TNC's software to begin operation. After loading the software, tune in an RTTY station so that it is properly decoded on your computer screen. When solid copy is obtained, you may press the appropriate key on your computer's keyboard to activate the transmitter, and begin typing. See your TNC's instruction manual for further details regarding actual operation.
- ⑤ The DSP High- and Low-Cut filter are particularly beneficial in reducing interference in RTTY pile-up situations. A typical setting of the **HIGH CUT** control is at approximately 1 o'clock, while the **LOW CUT** control may be set approximately to 11 o'clock.
- ⑥ The CW Narrow filter may also be used for AFSK operation. Just press the [**NARROW**] switch, then rotate the **SHIFT** control to peak the signal in the narrowed IF passband.
- ⑦ Via Menu # U-10, the Enhanced Tuning Scale may be engaged so as to allow a visual representation of precise tuning pursuant to the tone frequency selected via Menu # U-46. However, since your TNC may also have such a facility, and because the TNC is ultimately in control of the tone generation and decoding, you may wish to rely on the TNC's tuning indicator, and use the Enhanced Tuning Scale of your FT-920 for other purposes.
- ⑧ For 1200 bps FM packet, press the **DATA** key until **DATA** and **FM** appear on the display.

## FSK RTTY Operation

This mode utilizes the tone generator in the FT-920 for production of the required Mark and Space tones used for RTTY operation.

- ① Follow the interconnection guidelines on page 17 for details on how to hook up your terminal equipment to the transceiver. Be certain to set the **AFSK-FSK** switch on the rear panel of the trans-

ceiver to **FSK**. In this mode of operation, closing Pin 1 of the **DATA** jack to ground causes the carrier to shift; the magnitude of the shift (170/425/850 Hz) is set via Menu # U-43, while the carrier's offset from zero beat and its sideband (USB/LSB) can be set via Menu # U-42. Do not connect Pin 1 of the **DATA** jack to any TNC/TU line which carries "Mic AUDIO" or "Tx AUDIO" as these lines are used for AFSK operation (see previous section).

- ② Press the front panel [**DATA**] key to select the [**DATA**] [**LSB**] mode, which corresponds to "FSK" operation (remember, "**DATA USB**" is used for "AFSK" operation).
- ③ At this point, you are ready to utilize your TNC/TU's software to begin operation. After loading the software, tune in an RTTY station so that it is properly decoded on your computer screen or TU display. When solid copy is obtained, you may press the appropriate key on your computer's keyboard to activate the transmitter, and begin typing. See your TNC/TU instruction manual for further details regarding actual operation.
- ④ As with AFSK operation, the CW filter may be engaged in the FSK mode by pressing the [**NARROW**] key, and the DSP filters may also be used to reduce interference in crowded digital operating situations.

## Operating Tips

- ❑ If you are hearing and decoding stations successfully in an AFSK environment, but stations cannot understand you, check to be certain that your TNC's software has not set a shift other than 170 Hz, and be sure that the tones have not been "inverted" in the software configuration.
- ❑ If you are getting no shift (only a steady carrier) in RTTY FSK operation, be sure that you have not connected Pin 1 of the **DATA** jack to an AFSK output line from your TNC (use only the "FSK" line provided by your TNC). If the FSK line has been properly connected, check to be sure that you have the "FSK" mode properly enabled on your TNC, if the software requires you to do so.
- ❑ If you are having trouble decoding HF packet stations, be sure that you have set Menu # U-46 to one of the settings which ends with "**U**" (instead of "**L**"), and that you have chosen a tone frequency compatible with the tones for which your TNC is configured.

## AM Transmission

### (Optional YF-116A AM Filter Required)

The FT-920 utilizes low-level modulation on AM, and the DSP system may be used to enhance your transmitted audio quality.

Remember that AM consists of the carrier signal plus two sidebands. Because the available power output is 100 Watts (total), the *carrier* power should be limited to 25 Watts so as to have power available for the modulation sidebands, which carry your voice signal.

### Basic Operation

---

- ① Connect your microphone to the **Mic** jack.
- ② Set the following controls as described below:
  - MODE: AM**
  - METER SELECT: ALC**  
(The **ALC** indicator will appear on the display)
  - Mic GAIN:** Fully Counter-clockwise
  - RF PWR:** Fully Clockwise
- ③ Press the microphone's **PTT** switch. The **TRANSMIT** indicator on the display will become illuminated.
- ④ Rotate the **Mic GAIN** control clockwise while speaking into the microphone. When you reach the setting of the **Mic GAIN** control which causes the power output indication to increase slightly on voice peaks, reduce the setting of the **Mic GAIN** control slightly; this will be the point of best audio quality.
  - ✎ The PO meter will fluctuate significantly for an instant at the start of a transmission; this is not abnormal. However, if the ALC meter fluctuates significantly on voice peaks, the **Mic GAIN** control may be set too high, and your transmitted signal quality may be degraded. Reduce the setting of the **Mic GAIN** control if this is observed.
- ⑤ The DSP, VOX, and Monitor features are operational during AM transmission. See page 50 for a description of the DSP Voice Pattern Contours, and page 49 for details regarding VOX operation. Monitor operation is discussed on page 50.
- ⑥ For low-power operation, reduce the setting of the **RF PWR** control.

## FM Operation

### (Optional FM-1 Unit Required)

FM operation is permitted only in the 29 and 50 MHz bands, due to bandwidth limitations. Be careful while operating in the 29 MHz band to operate only in the FM sub-band above 29.5 MHz, so as to avoid harmful interference to satellite operations below 29.5 MHz.

### Simplex (Non-Repeater) Operation

---

- ① Connect the microphone to the **Mic** jack. Set the **MODE** switch to **FM**, and the **RF PWR** control fully clockwise.
- ② Close the microphone's **PTT** switch to activate the transmitter. Speak into the microphone in a normal voice level. The microphone gain level is set automatically in the FM mode, and is not affected by the **Mic GAIN** control's setting.
- ③ Release the **PTT** switch to return to the receive mode.
- ④ The VOX, and Monitor features are operational during FM transmission. See page 49 for details regarding VOX operation. Monitor operation is discussed on page 50.

### Repeater Operation

---

The FT-920 may also be used, in the FM mode, for repeater operation. Several convenient features make FM repeater operation simple and efficient.

- ① While operating in the FM mode on the 29 or 50 MHz bands, press the front panel **[RPT]** key to activate repeater operation. Pressing the **[RPT]** key causes two important functions to become activated:
  - The transmitter frequency will be shifted by a default value (100 kHz on 29 MHz, 500 kHz on 50 MHz) so as to access the repeater input frequency;
  - A repeater access tone will be superimposed on your signal, as many repeaters on these bands use CTCSS to prevent false activation of the repeater by random noise. Both Subaudible (CTCSS) and Burst (1750 Hz) tones are available.
- ② If the above repeater shifts and/or access tone are not appropriate for your area, they may be set independently for each band. The Menu items which pertain to these functions are shown below.
  - To set the 29 MHz CTCSS Tone Mode (CTCSS/ Burst), use Menu Item U-35 (see page 77).

- ❑ To set the 50 MHz CTCSS Tone Mode (CTCSS/Burst), use Menu Item U-36 (see page 77).
  - ❑ To set your FT-920's transmitted CTCSS tone (Menu Item U-35/36 must be set to **CONTI**), use Menu Item U-37 (see page 78).
  - ❑ To set your FT-920's CTCSS Decoder CTCSS tone, use Menu Item U-38. The default value is "Off," which means that Tone Squelch (CTCSS Decode) operation is not engaged. Set this Menu item to the appropriate tone so as to keep your receiver quiet until the matching tone is received from the repeater.
  - ❑ To set the 29 MHz repeater shift, use Menu Item U-39 (see page 78).
  - ❑ To set the 50 MHz repeater shift, use Menu Item U-40 (see page 78).
- ③ One press of the **[RPT]** key will have set the FT-920 for "Minus Shift" operation. In this situation, you will observe both the "-" and "RPT" indicators on the display. If your repeater uses a *positive* shift (instead of negative), press the **[RPT]** key again; the "+" indicator will replace the "-" indicator on the display, while "RPT" will remain illuminated.
    - ✍ The majority of repeaters on the 29 and 50 MHz bands use "-" shift.
  - ④ Set the FT-920's receiver to the repeater output (downlink) frequency.
  - ⑤ Close the **[PTT]** switch and speak into the microphone. You will observe that the transmitted frequency has shifted according to the setting of the **[RPT]** key.
  - ⑥ Release the **[PTT]** switch to return to the receive mode.
  - ⑦ Since FM is a continuous-duty mode, we recommend you rotate the **RF PWR** control counter-clockwise so as to use the minimum power necessary to gain access to the repeater. This will significantly reduce the amount of heat generated by the transmitter section.
    - ✍ Since repeaters do not all use the same access tone, we recommend that you load your favorite repeater frequencies into memory, to avoid the inconvenience of always having to reset the CTCSS tone frequency. When a repeater frequency is stored into memory, the receive frequency, shift direction, shift magnitude, and tone information are all stored into the memory register. See page 59 for details of memory operation.

## Linear Amplifier Tuning

A special feature of the FT-920 allows you to do low-duty-cycle tune-up of your linear amplifier by transmitting a high-speed pulse, instead of a continuous carrier.

Here is how to do this:

- ① Press **[MENU]** to enter the Menu mode.
- ② Select Menu Item U-55 by rotating the VFO-B Tuning Dial, then press **[ENT]** and rotate the VFO-B Tuning Dial to select the amount of time you want the pulser to be active (the default time period is 10 seconds). Now press **[ENT]** again.
- ③ Rotate the VFO-B Tuning Dial to select Menu Item U-52 ("LI-TU-S"). When you press **[ENT]**, the pulser will commence transmission. The number of seconds remaining in the transmission will appear on the main frequency display area.
- ④ Once the countdown is complete, the Menu display will say "OFF," and you may either repeat the tune-up pulse transmission by pressing **[ENT]** again, or exit to normal operation by pressing **[MENU]**.

The duration of the tune-up time may be adjusted via Menu Item U-55. The length of the transmitted pulses is adjusted via Menu Item U-57 (default: 100 ms.), while the interval *between* pulses may be adjusted via Menu Item U-56 (default: 100 ms.). You therefore can adjust the duty cycle to your requirements. You may wish to reduce the interval time (via U-56) to a very low value, such as 10 ms., so as to make the transmitted pulses resemble a continuous carrier.

The power output used during this tune-up procedure can also be set independently for the Antenna-A port and the Antenna-B port. The power output used during this tune-up procedure (not during regular operation) may be set via Menu Item U-53 (Antenna-A) or U-54 (Antenna-B).

The FT-920 provides a wide variety of memory system resources. These include:

- ❑ 99 "standard" memory channels, numbered "01" through "99."



- ❑ Five QMB (Quick Memory Bank) channels, providing one-touch storage and recall of prime operating frequencies. The QMB channels are labeled “C-1” through “C-5.”
- ❑ Ten Split Frequency memory channels, used for storing frequency settings when the transmitter and receiver frequency are different. The Split channels are labeled “d-01” through “d-10.”
- ❑ Eleven Call channels, for storage and quick recall of one prime frequency on each amateur band. These channels are labeled “S-01” through “S-11.”
- ❑ One set of band-edge memories, also known as “Programmable Memory Scan” channels, labeled “LO” and “HI.”

These memories do not just store away the operating frequency; thanks to the enhanced memory space provided in the FT-920, the following data will be stored into each memory channel:

- ❑ Operating frequency
- ❑ Operating mode (LSB, USB, CW, etc.)
- ❑ Receiving filter bandwidth
- ❑ Clarifier information (offset direction and magnitude) except on PMS and CALL channels
- ❑ Antenna jack selection
- ❑ Automatic Antenna Tuner status (On/Off) except on QMB and CALL channels
- ❑ Repeater Shift information (except on QMB and PMS channels)
- ❑ Repeater CTCSS tone information (except on QMB channels)
- ❑ Alphanumeric Labels (except on QMB channels)
- ❑ Lock switch status (except on QMB channels)

Storage and recall of memory channels in the various memory systems is quite straightforward, thanks to the advanced ergonomic design of the FT-920. These procedures are detailed below.

## **QMB Channel Programming/Recall**

The QMB (**Q**uick **M**emory **B**ank) memories are designed for urgent operating situations where very

simple storage and recall procedures are desired.

### QMB Channel Storage

- ① While using VFO-A, tune in the desired frequency on the Main Tuning Dial.
- ② Press and hold in for ½ second the [**QMB STO**] key until the double beep is heard. The double beep provides audible confirmation that the memory storage was successful.
- ③ As you dial up other frequencies in the VFO mode, repeating the procedure in, above causes the QMB memory system to cycle through the QMB channels in the following sequence:  
C-1 ⇒ C-2 ⇒ C-3 ⇒ C-4 ⇒ C-5 ⇒ C-1 ⇒ C-2 ⇒ ...  
Frequency data will be stored and purged on a first-in, first-out basis.

### QMB Channel Recall

- ① Press the [**QMB RCL**] key to recall the currently-active QMB channel. The “QMB” indicator on the display will become illuminated.
- ② Press the [**QMB RCL**] key repeatedly to cycle through the QMB channels, in the same sequence as shown for QMB Channel Storage.
- ③ While operating in the QMB Channel Recall mode, you are not “fixed” on the QMB channel; you may tune away from the QMB channel frequency, using the Main Tuning Dial, as though you were in the VFO mode. In this situation, the “QMB” indicator will be replaced by one which indicates “M TUNE.” To return to the originally-stored QMB channel, press the [**QMB RCL**] key once.

## **Memory Operation on “Regular” Memory Channels**

# Memory Operation

## (Channel #1-01 to 1-99)

### Memory Channel Storage

- ① While using VFO-A, tune in the desired frequency on the Main Tuning Dial. Set the operating mode, bandwidth, Clarifier mode and offset, and Antenna (A or B) as desired. If using the Automatic Antenna Tuner, you may wish to touch up its alignment by pushing and holding in the [TUNER] key for ½ second.
- ② Press the [V ► M] switch momentarily to enter the “Memory Check” mode, which is used to find an unused memory channel. The “M CK” indicator on the display panel will blink, and the frequency stored (if any) on the current memory channel will be shown in the VFO-B display area.  
**Note:** The VFO-B Tuning Dial may also be used for the “M CK” mode. See “Memory Channel Selection using VFO-B Tuning Dial” at the right.
- ③ Use the [UP▲] or [DOWN▼] key to increment through the main channel bank. Frequency data stored previously in memory channels will be displayed in the VFO-B display area. If you have restricted memory operation to one channel group (by pressing the [MEM GROUP] key), memory storage will similarly be limited to the currently-selected memory group; just press [MEM GROUP] again to allow unrestricted access to all memory channels for storage of your frequency data.
- ④ When you have selected the channel location into which to store the frequency information, press and hold in the [V ► M] key for ½ second, until you hear a double beep, which confirms that the frequency information was successfully stored.

**Note:** If information was previously stored on the channel into which you stored data in step ④ above, the previous data will be overwritten and lost!

### Memory Channel Recall

- ① If you currently are in the VFO tuning mode, press the [VFO/MEM] key once to enter the “Memory”

mode (the “MEM” icon will appear below the main frequency display).

- ② To select another memory channel, press either the [UP▲] or [DOWN▼] key. Repeated pressing of one of these keys allows you to step through the memory channels one at a time, or you may hold in the [UP▲] or [DOWN▼] key to step through the channels in a “manual scan” mode.

**Note:** The VFO-B Tuning Dial may also be used for Memory Channel selection. See “Memory Channel Selection using VFO-B Tuning Dial” below.

- ③ To restrict your memory channel selection just to one memory group, press the [MEM GROUP] key once (the “GROUP” icon will appear above the chan-

### Memory Channel Selection Using VFO-B Tuning Dial

You may find it more convenient to use the VFO-B Tuning Dial, instead of the [UP▲] and [DOWN▼] keys, for memory channel selection. Here’s how to do this:

- ① Press the [MEM CH] key (located below and to the left of the VFO-B Tuning Dial) momentarily. The brackets surrounding the memory channel number display will start to blink.
- ② Now rotate the VFO-B Tuning Dial. You will observe the channel numbers changing, and you may select the desired memory channel quickly in this manner.
- ③ To revert to normal operation of the VFO-B Tuning Dial, press the [MEM CH] key once more.

nel number). Now, only those channels within the current memory group (designated by the digit preceding the hyphen in the memory channel number) will be available for recall via step , above.

To change memory groups, press the [MEM GROUP] key again (so that the "GROUP" icon disappears), then use the [UP▲] or [DOWN▼] key to step through the channels until you enter another group. You may now press the [GROUP] key again to restrict memory channel access to the newly-selected group.

- ④ Once you are operating on a memory channel, you may tune off of the original frequency (as though you were in the VFO mode). Just rotate the Main Tuning Dial; the "MEM" icon will be replaced by one which indicates "MEM TUNE," indicating that you have now shifted into the "Memory Tune" mode.

When operating in the Memory Tune mode, if you find another frequency you wish to store into another memory channel, just press the [V ► M] key momentarily (the channel number will blink), select a new memory channel via the [UP▲] or [DOWN▼] key, then press and hold in the [V ► M] key for ½ second (until you hear the double beep). To exit the Memory Tune mode, press the [VFO/MEM] key as follows:

- ❑ One touch of [VFO/MEM] returns you to the *original* memory frequency. The "MEM TUNE" indicator will be replaced by "MEM."

- ❑ A second touch of [VFO/MEM] will cause you to exit the Memory mode and return to the VFO mode (the "MEM" indicator will be replaced by "VFO").

- ⑤ Note that repeater offsets (used on 29 MHz and 50 MHz FM) *can* be stored into "regular" memory channels; there is no need to utilize the "Split" memories described later for repeater operation. Moreover, Clarifier data is also stored into "regular" memory locations, so small (<9.99 kHz) Tx/Rx splits can be accommodated using the Clarifier.

## Memory Operation on Split-Frequency Channels

### Memory Group Information

The FT-920's main memory area may be divided into as many as four groups. These groups may, in some instances, provide more efficient or intuitive memory operation; for example you might wish to segregate memories according to operating objectives, such as:

- ❑ AM Broadcast Stations
- ❑ Shortwave Broadcast Stations
- ❑ HF Amateur Stations
- ❑ 50 MHz Amateur Stations

Once you have determined how many memories are to be designated in each group (see Menu Items U-11 ~ U-14), you may restrict memory operation just to one group, or you may allow the memory channels to be selected without regard to memory group boundaries.

The complete memory channel number is composed of two sets of numbers, separated by a hyphen. The single digit before the hyphen is the memory group number (1, 2, 3, or 4). The second, two digit number is the channel number itself (1 to 99). Therefore, if channel #34 is assigned to group #1, its channel number is "1-34." If you have created four channel banks of 24~25 channels each, channel #34 would be designated "2-34" since it falls within channel group #2.

# Memory Operation

## (Channel #d-01 to d-10)

Some operating circumstances require the receive and transmit frequencies to be separated by a frequency range in excess of that provided by the Clarifier feature (>9.99 kHz). For example, international SSB operation on the 7 MHz band may require one station to transmit in the frequency range 7.040 ~ 7.100 MHz, while the other station must transmit in the 7.150 ~ 7.300 MHz range. The FT-920 provides ten special memories for such operating instances. Storage and recall are similar to that described previously.

### Split Frequency Memory Channel Storage

- ① Set VFO-A to the required receive frequency and mode, and set VFO-B to the required transmit frequency and mode.
- ② Press the (Orange) VFO-B “TX” LED/Switch to activate the Split mode, previously discussed on page 54.

**Note:** *It is also acceptable to store the transmit frequency on VFO-A and the receive frequency on VFO-B, if you prefer. In this case, in step, above, press the VFO-B “RX” LED/Switch to set up the appropriate Tx/Rx relationship between the two VFOs.*

- ③ Press the [V ► M] switch momentarily to enter the Memory Check mode (the “M CK” indicator will blink), then use the [UP▲] or [DOWN▼] key to select the memory channel you wish to use (from the special “Split” memories numbered “d-01” through “d-10”).
- ④ When you have chosen the desired memory channel, press and hold in the [V ► M] key for ½ second to lock the split frequency data into the chosen memory location. As usual, a double beep will indicate when you have held in the [V ► M] key long enough.

### Split Frequency Memory Channel Recall

- ① While operating in the VFO mode, press the [VFO/MEM] key once to enter the Memory mode. The

“MEM” indicator will appear on the display, replacing the “VFO” indicator. It does not matter whether or not you are operating in the “Split” mode at this time.

- ② Next, press either the [UP▲] or [DOWN▼] key to select the desired channel from within the d-01 ~ d-10 Split Memory bank. The (differing) transmit and receive frequencies will be indicated on the left and right sides of the frequency display, and the VFO-A and VFO-B Tx and Rx LED/Switches will be illuminated according to the relationship you programmed.
- ③ Particularly during 7 MHz pile-up situations, it may be necessary to adjust your transmit frequency (which *usually* will be stored in VFO-B). The Memory Tune function is active with respect to *either* the VFO-A or VFO-B Tuning Dial, so you may adjust either dial freely, as desired, if you need to retune. The “M TUNE” indicator will appear, and you may, as described earlier, store the retuned frequency into another memory, if desired. Alternatively, press the [VFO/MEM] key once to return to the original split frequency pair, and press it once more to exit the memory and return to VFO operation.
- ④ As a convenience during Memory operation, once you have recalled a channel within the Split Memory Bank (channel #d-10 ~ d-10), you may press the [MEM GROUP] key to restrict memory access *only* to the Split Memory Bank. Press the [MEM GROUP] key again to restore free memory channel access.

## Memory Operation on “CALL” Channels

## (Channel #C-01 to C-11)

The “CALL” channels are easy-access memories which may serve as convenient starting points for operation. Many operators use them for quick recall of favorite frequencies in each band.

There is no *requirement* that you assign one frequency per band. However, the CALL Channel feature includes a simple method of recalling these special memories (described later) which involves the pressing of one of the [BAND] keys. Therefore, the procedure for storing memories band-by-band will be described below for illustrative purposes.

### Storing Data in CALL Channels

- ① While operating on VFO-A, select the “favorite frequency” you wish to have stored as your “CALL” frequency on the current band.
- ② Press the [V ► M] key once momentarily; the “M CK” indicator will blink, and the frequency store in the current memory channel will be shown in the VFO-B display area.
- ③ Now press either the [UP▲] or [DOWN▼] key (or use the VFO-B Tuning Dial by pressing the [MEM CH] key first) to select the CALL Channel memory assigned to the band currently in use. See the table below for a listing of the bands and their assigned memory locations for the CALL Channel function. The CALL Channels are assigned memory locations “C-01” through “C-11.”
- ④ Next, press and hold in the [V ► M] key for ½ second (until you hear the double beep) to lock the frequency into the chosen memory location.
- ⑤ You may now repeat this process for the other CALL Channels, preferably assigning one such channel per band.

**Note:** Channel “C-10” already is programmed (at the factory) with the following frequency:

C-10: 51.000.00MHz (FM)

### Recall of CALL Channel Memories

- ① Whether in VFO or Memory operation, recall of CALL Channels is very easy. Just press *and hold*

in the [STEP] key (below and to the left of the VFO-A Tuning Dial) and press the [BAND] key (on the keypad) corresponding to the desired band.

*For example*, to recall the 40-meter CALL Channel, press and hold in [STEP], then press the [7 MHz] key while you are holding in [STEP]. To recall the 12-meter CALL Channel, press and hold in [STEP] and press [24.5 MHz].

**Note:** *If you are operating in the “Memory Tune” mode, activating the CALL Channel system will cancel the Memory Tune function, and place the transceiver directly into the Memory mode.*

- ② Since the CALL Channels are not segregated into an isolated memory band, like the QMB memories, you also may access these memories via the [UP▲] and [DOWN▼] keys, or via the VFO-B Tuning Dial, as with “regular” memories.
- ③ When operating on a CALL Channel, it is possible to utilize the Memory Tune mode in a manner similar to that used on “regular” memories. Just rotate the VFO-A Tuning Dial, as desired, to tune off of the pre-programmed CALL Channel frequency. The new frequency may be stored in another memory, if desired, as described on page 60.

To cancel Memory Tune operation, press the [VFO/MEM] key once (or press and hold in [STEP] and press another [BAND] key for another CALL Channel).

## **Adding Alpha-Numeric Labels to Memory Channels**

Each of the memory channels in the FT-920, except

# Memory Operation

for the QMB channels, may be appended with a seven-digit Alpha-Numeric Label which may aid in memory channel recognition. Such Labels can be particularly useful for identifying Shortwave Broadcast stations stored in memory, especially because identification can be difficult if they are broadcasting in a foreign language you do not understand. Alpha-Numeric Label programming is simple to accomplish using the front panel knobs and/or the keys.

- ① First recall the memory channel to which the Label is to be appended.
- ② Press the [DISPLAY] key (located immediately to the right of the VFO-A [TX] LED/Switch); any previously-stored Label will be displayed in place of the VFO-B frequency display.
- ③ Now press the [ENT] key on the keypad. The first “dash” in the VFO-B display area will now blink, signaling you that Alpha-Numeric entry may begin.
- ④ Rotate the VFO-B Tuning Dial to select the letter or number you wish to enter into the first Label slot. You may also use the [BAND] keys by pressing repeatedly on a particular key until one of the letters or the number stamped on the key appears (for example, repeatedly pressing the [7 MHz] key toggles between **D** ⇒ **E** ⇒ **F** ⇒ **3**). Rotating the VFO-B Tuning Dial is usually faster, however.
- ⑤ After you have chosen the first letter/digit for the Label, press the [UP▲] key. A blinking “dash” will appear to the right of the first digit. Choose the next letter/digit as in the previous step. Press the [UP▲] key to advance the entry position as you fill up the Label register, up to a maximum of seven characters.
- ⑥ When entry is complete, press the [ENT] key. You will hear a double beep, which confirms that the Label storage process was successful.
- ⑦ If you make a mistake during entry, you may use the [DOWN▼] key to step backward through the Label field. If you wish to leave a blank space, just press the [UP▲] key without choosing a letter. To create a space where a letter/digit exists from a previous entry, the character one increment counterclockwise from the “A” on the VFO-B Tuning Dial will inject a space; you may also use the third selection on the [50 MHz] key (“\_”), if you prefer keyboard entry.
- ⑧ Press the [DISPLAY] key to revert to display of the operating frequency, instead of the Alpha-Numeric Label. Press [DISPLAY] once more to return to display of the Label.
- ⑨ Labels generally are not appended to Split Frequency channels, as they are usually stored for 7 MHz SSB applications where one or both frequencies may change often. If you *must* store a Label on a Split channel, the Label will, of course, obscure the display of the VFO-B frequency (usually the Tx frequency). However, if you move the VFO-B Tuning Dial (thus entering the Memory Tune mode) so as to adjust your Tx frequency, the display will *instantly* revert to indication of the frequency, and will stay in that condition for about four seconds after tuning has stopped. Then the Label will return.

## Memory Mode Accessories

### Moving Memory Data to VFO-A

Data stored on memory channels can easily be moved to VFO-A, if you like.

- ① First use the [UP▲] or [DOWN▼] key (or the VFO-B Tuning Dial, after pressing [MEM CH]) to select the memory channel containing the frequency data to be moved to VFO-A.
- ② Next, press and hold in the [M ► V] key for ½ second until you hear a double beep. The data will now have been copied to VFO-A, although the original memory contents will remain intact on the previously-stored channel.
- ③ If a Split Frequency Memory Channel was transferred, the Rx/Tx frequency relationship will not be changed by the action in the previous step. That is, if the Tx frequency was originally stored via VFO-A and the Rx frequency stored via VFO-B, that relationship will remain unchanged after the Memory-to-VFO transfer process.

### Deleting Data from a Memory Channel

Frequency data stored on a memory channel can be deleted from a memory channel, if desired. The de-

letion process is not a “hard” erasure, so if you erase a channel by mistake using this procedure, the memory channel contents can be recovered.

- ① First use the [UP▲] or [DOWN▼] key (or the VFO-B Tuning Dial), from the Memory mode, to select the memory channel containing the data to be deleted.
- ② Next, press and hold in the [V ► M] key for ½ second until you hear the double beep. At this point, the memorized frequency and other data will disappear. The data is now “masked” and will not be available for operation.
- ③ To restore the masked frequency data, repeat steps ① and ② above. However, if you store new frequency information on a channel containing masked data, the masked data will be over-written and lost.

The FT-920 contains a wide variety of scanning capabilities. Whether you are in the VFO mode or one of the Memory modes, scanning operation is funda-

# Scanning Operation

mentally identical in all modes of operation, but with the following differences:

- ❑ In the VFO mode, scanning causes the transceiver to sweep up or down the band, pausing or halting on any signal encountered;
- ❑ In the QMB mode, the scanner will scan *only* the QMB memory bank;
- ❑ In the “regular” Memory mode, the scanner will scan the *programmed memories*, and can be instructed to *skip* certain memories during scanning;
- ❑ In the “regular” Memory mode, with “Group” Memory activated, the scanner will scan *only* the memories within the *current group*; and
- ❑ In the Programmable Memory Scan (PMS) mode, the scanner will scan the band *within user-programmed frequency limits*.

## Scanning operation is easy to perform:

- ① Set the [SQL] (Squelch) control to the point where background noise is silenced. A typical setting, for effective scanning operation, will be at 12 o'clock or slightly clockwise from this position.
- ② Set the transceiver into the operating configuration in which you wish to scan (VFO, Memory, QMB, etc.).
- ③ Press and hold in either the [UP] or [DOWN] switch on the microphone to initiate scanning. On the MD-100A8X, rotate the scanning ring to the left for downward scan, or to the right for upward scan.

**Note:** *If you are scanning in the VFO mode, note that complete rotation of the scanning ring to the end of its travel will place the radio in a “fast scan” mode which may aid you in navigating quickly across a band.*

- ④ The scanner will now cause the transceiver to increment in the chosen direction until a signal is detected. When a signal is encountered which opens the Squelch, the scanner will pause until the signal disappears (at the end of the other station's transmission), at which point the scanner will resume. While the radio is in the “Pause” condition, the decimal points in the Main VFO-A frequency display area will blink. See “Scan-Resume Choices” below for details of how to customize the resumption of scanning.
- ⑤ Press the [PTT] switch on the microphone to cancel scanning and return to normal Tuning Dial operation.

## Scan Skip Programming (Memory Mode Only)

Among the memories you have programmed, there may be some stations which you do not wish to scan. For example, standard time stations like WWV, JJY, CHU, LOL, RWM, or VNG transmit a continuous carrier which might always stop the scanner (thus preventing you from encountering a different station). Therefore, you may designate certain memory channels to be *skipped* during *scanning*, but otherwise left intact for manual channel selection.

Here's how to remove a channel from the scanning loop:

- ① Recall the memory channel to be skipped.
- ② Press and hold in the [MEM GROUP] key for ½ second, until the “SCAN” indicator on the display panel goes off; this shows that this channel is now not eligible for scanning.
- ③ Repeat steps ① and ② as many times as necessary to skip all the channels you do not wish to scan.
- ④ Initiate memory scanning (as described previously), and you will observe that the channels you marked to be skipped are not included in the scanning loop. Press the [PTT] switch to stop the scan; now use the front panel or microphone [UP] or [DOWN] key to step through the channels manually - one at a time - and you will observe that the “skipped” channels are, nonetheless, available for recall by manual means.
- ⑤ You may restore a previously-skipped channel to the scanning loop by selecting the channel manually; then press the [MEM GROUP] switch for ½ second until the “SCAN” indicator is restored to the frequency display panel.

## Programmable Memory Scan (PMS) Operation

The PMS scanning mode allows you to set up band limits within which to scan. For example, you might elect to scan 50.0 to 50.4 MHz in USB mode, watching for activity. The procedure for establishing such band limits is quite easy:

- ① First, store the lower frequency limit in the “P-Lo” memory channel, and the upper frequency limit in the “P-Hi” memory channel. In the above example, you would store 50.000 MHz in “P-Lo,” and 50.400 MHz in “P-Hi.”
- ② Next, switch from the VFO mode to the Memory mode by pressing [VFO/MEM].



- ③ Now activate the “Memory Tune” mode by rotating the VFO-A Tuning Dial slightly either direction. You will observe the [M TUNE] indicator on the display.
- ④ Rotate the [SQL] control until the background noise is silenced, then press the microphone [UP] or [DOWN] switch (or rotate the scanning ring, if using the MD-100A8X Desk Microphone) to initiate scanning. The transceiver will now scan within the range 50.000 to 50.400 MHz, halting on any signals received, then resuming its scan based on the setting of Menu Item U-15 (see below).
- ⑤ Note that these band limits do not apply just to scanning; they are also applied to the operation of the VFO-A Tuning Dial, so the PMS feature makes it easy to stay within a particular band of operation whether tuning manually *or* scanning!

## Scan-Resume Choices

Scanning operation requires that you have the FT-920's audio squelched. The transceiver then assumes that the opening of the squelch corresponds to the discovery of a signal you may wish to listen to.

Once the scan has been halted, one of three things may happen:

- The *default* action is that the transceiver pauses on the signal and stays locked on its frequency until the other station's transmission ceases (at which point the squelch will close). One second after the squelch closes, scanning resumes automatically. The resumption interval is adjustable from 0 to 10 seconds via Menu Item U-17 (see page 75).
- Another option is that the scanner will halt, when the squelch opens, for a fixed time period (default = 5 seconds). Thereafter, scanning will resume whether or not the other station's transmission has ended. The “hold” time is adjustable from 1 to 60 seconds via Menu Item U-16 (see page 75).
- The scanner can also be programmed to stop when it finds a signal, and lock on that frequency without resuming the scan at some point.

The scan-resume choices may be selected via Menu Item U-15 (**SCN-STP**); see page 75 for details.

Scanning is chiefly useful in the FM mode, when you are monitoring a number of repeater or simplex channels. When operating on the 50 MHz band, the number of channels per second may be adjusted via Menu Item U-19; the default value is 10 channels per second.

When scanning in a narrow-band mode such as SSB or CW, a signal may occupy a number of synthesizer steps over its entire bandwidth. Tuning across a CW signal in, for example, 2.5 Hz steps, will take a considerable amount of time at 1 step per second, especially if the signal is strong. But until the signal is fully passed, the squelch will stay open, thinking that it is finding a new station every 2.5 Hz! Therefore, when scanning a band in anticipation of a band opening, you may wish to press the [FAST] key, and reduce the Pause Time (Menu U-16) to about 1 second, so as to reduce the holding time on a signal which is encountered.

Dual Watch is similar, in some respects, to scanning. In Dual Watch, however, the transceiver monitors (squelched) on the Main Rx frequency (typically VFO-

# Dual Watch Operation

A) while periodically checking the Sub VFO (typically VFO-B) for activity. A typical example might be for you to set VFO-A to 50.110 MHz, watching for DX stations who might call CQ on that frequency, while periodically checking 28.885 MHz for stations reporting band openings on 6 meters.

To activate Dual Watch:

- ① Set up transmit and receive operation on VFO-A, establishing your primary monitoring frequency. Set up the frequency to be checked periodically on VFO-B.
- ② Verify that the correct antenna (A or B) has been selected for VFOs A and B, if they are on different bands. The Dual Watch feature will automatically switch antennas for you during the VFO-A/B switching process.
- ③ Rotate the **[SQL]** control until the background noise is silenced.
- ④ Press the **[DW]** key. The decimal points in both frequency displays will blink, and you will observe that, every few seconds, the green “**RX**” indicator for VFO-B will become illuminated for an instant. This shows you when VFO-B is being checked for activity.
- ⑤ If a station is detected on the VFO-B frequency, the FT-920 will pause on the VFO-B frequency, and stay there according to the Menu selections

you made per the “Scan-Resume Choices” earlier.

- ⑥ Press **[DW]** again to cancel Dual Watch. Note that pressing the **[PTT]** switch on the microphone does *not* cancel Dual Watch operation.

The time interval between Dual Watch excursions to VFO-B may be adjusted, via Menu Item U-18, to any value between 3 and 15 seconds. The default setting is 10 seconds.

The VFO-A register need not be in the “VFO” mode; it may also be set to a Memory Channel or a QMB channel, if you like.

Note also that the active Rx VFO at the time that **[DW]** is pushed will be the one on which the transceiver will hold, checking the opposite VFO periodically. Therefore, if the green “**RX**” LED for VFO-B is illuminated when you push **[DW]**, the FT-920 will hold on VFO-B, then check VFO-A periodically for activity.

Remember that the squelch must be engaged in order for Dual Watch to function. During Dual Watch, transmitting remains enabled, and the VFO frequencies may be changed.

The FT-920’s Menu System allows you, the owner, to customize a wide variety of transceiver performance aspects and operating characteristics. Such

# Menu Operation

a large number of adjustments would ordinarily require dozens of additional knobs on the front panel of the transceiver, thus complicating operation hopelessly. The Ergonomics Design Team at Yaesu Musen Co., Ltd. therefore created the Menu System such that virtually all Menu items are of the “set and forget” variety, not requiring revision during day-to-day operation.

Three Menu operating modes are provided, allowing different avenues of access to the Menu System. These are:

- ❑ Normal Menu operation (73 selections), accessed by pressing the [MENU] key.
- ❑ Panel Menu operation (5 fixed selections), accessed by holding in the [STEP] key plus one additional key, providing instant access to critical Menu items.
- ❑ Quick Menu operation (5 user-selected items), accessed by pressing the [MENU] key after activation via Menu Item U-67. When Quick Menu has been activated, Normal Menu operation is activated by pressing and holding in the [MENU] key for ½ second.

Here are operating procedure summaries for each Menu mode.

## Normal Menu Operation

- ① Press the [MENU] key once momentarily. The Menu

Item number will start blinking, and a brief title for the Memory Item will appear at the far right side of the display.

- ② Rotate the *VFO-B Tuning Dial* to select the Menu Item you wish to work on.
- ③ When you have chosen the desired Menu Item number, press [ENT] on the keypad momentarily. The current value or condition for the Menu Item chosen will be shown in the main frequency display area.
- ④ Again rotate the *VFO-B Tuning Dial*, or press the front panel [UP▲] or [DOWN▼] keys, to change the value or condition for the Menu Item.
- ⑤ When you have made your selection, press [ENT] to lock in your setting. You may now select another Menu Item number to work on (by rotating the VFO-B Tuning Dial) or press [MENU] to exit and resume normal operation.

## Panel Menu Operation

Five more-frequently-used Menu Items have been

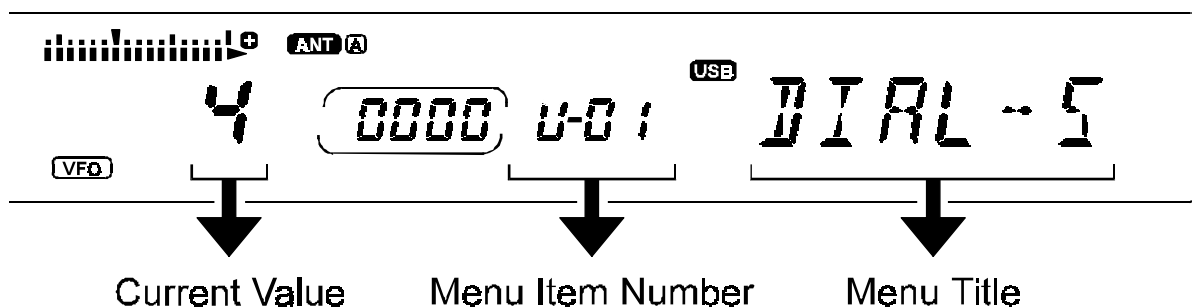

# Menu Operation

stored in a special Menu Bank which allows you to recall them quickly by pressing *and holding* in the [STEP] key while pressing *another* key. These Menu Items are shown below:

For example, here is how to use the Panel Menu fea-

Menu #	Function Description	Press this key while Holding in [STEP] key
U-08	Display Dimmer On/Off	[DISPLAY] Key
U-09	Multi Panel Display Choice	[A > B] key
U-10	Enhanced Tuning Scale Display	[METER SELECT] Key
U-24	"VOX" Hang Time in CW Mode	[BK-IN] Key
U-37	(TX) CTCSS Tone Frequency	[RPT] Key

ture to activate the Display Dimmer:

- ① Press and hold in the [STEP] key.
- ② While you are holding in the [STEP] key, press the [DISPLAY] key. Menu **U-08** will appear just to the left of the "DIMMER" title, and "oFF" will blink in the main display area. This means that the current condition of the Dimmer is **Off**.
- ③ Rotate the VFO-B Tuning Dial to select "on;" you will note that the display just got darker.
- ④ Press the [ENT] key on the keypad. You may now rotate the VFO-B Tuning Dial if you want to change some other Menu Item, or just press [MENU] to exit the Menu System and resume normal operation.

## Quick Menu Operation

The Quick Menu feature allows *you* to select certain Menu Items you feel the need to change more frequently. These are assembled into Quick Menu bank which operates almost identically to the "Normal" Menu mode. However, access is very slightly different:

- ❑ When you have created a Quick Menu, you activate it by pressing [MENU] *momentarily* (as described above in the "Normal Menu Operation" section). You now *only* have access to the Quick menu Items.
- ❑ To gain access to the other "Normal" Menu Items, press [MENU] and hold it in for ½ second (instead of pressing it momentarily).

After you have done one of the above actions with

the [MENU] key, operation is identical to that described in the "Normal Menu Operation" section.

The Quick Menu bank is set up by first accessing Menu Item U-67 via Normal Menu operation. For illustrative purposes, we shall create a Quick Menu bank consisting of Menu Items U-01, U-02, and U-03:

- ① Press the [MENU] key momentarily to enter the Menu mode.
- ② Rotate the VFO-B Tuning Dial to select Menu Item U-67. The Title for this item is "Q MENU," and the default value is "U-01 oFF."
- ③ Press the [ENT] key to enter the Menu Item Command mode. The "U-01 oFF" display will blink.
- ④ Now press the [UP▲] key to change the "oFF" to "on" relative to U-01.
- ⑤ Rotate the VFO-B Tuning Dial to select Menu Item U-02 . Again press [UP▲] to change the "oFF" to "on."
- ⑥ Rotate the VFO-B Tuning Dial to select Menu Item U-03. Again press [UP▲] to change "oFF" to "on."
- ⑦ Press the [ENT] key to lock in the new settings for U-67, then press [MENU] to exit.
- ⑧ Now press [MENU] momentarily, and rotate the VFO-B Tuning Dial. You will see that you have access only to Menu Items U-01, U-02, and U-03. Press [MENU] to exit.
- ⑨ Press and hold in the [MENU] key for ½ second, then rotate the VFO-B Tuning Dial. You will see that you now have access to *all* Menu Items. Press [MENU] to exit.

We will now provide a summary chart showing the Menu Items available, followed by a more comprehensive description of each Menu Item and the choices available.

## Menu Mode Summary Chart

## Menu Mode Selections and Settings

Menu #	Function of Menu Item	Available Choices	Default
U-01	VFO Dial Speed	X2, X4	X4
U-02	Up/Down Switch Steps	0.5 kHz ~ 1000 kHz/Step	100 kHz
U-03	Step Switch Function	Toggle/Momentary	Toggle
U-04	Quick Split Offset	Off/-100 kHz ~ +100 kHz	Off
U-05	TX When Spot is Pressed	On/Off	Off
U-06	Beep Frequency	Off/220 Hz ~ 7040 Hz	880 Hz
U-07	"Peak Hold" Metering	0(Off) ~ 2000 ms.	Off
U-08	Display Dimmer Control	On/Off	Off
U-09	Multi-Panel Display Item	Clarifier/Pitch/Offset	Clarifier
U-10	Enhanced Tuning Scale	Clar./DSP/Tuning/Fine Tuning	DSP
U-11	Memory Channel Group 1	1 ~ 99	99
U-12	Memory Channel Group 2	{{Last # in Grp. 1)+1} ~ 99	Off
U-13	Memory Channel Group 3	{{Last # in Grp. 2)+1} ~ 99	Off
U-14	Memory Channel Group 4	{{Last # in Grp. 3)+1} ~ 99	Off
U-15	Scanning Mode	Carrier Drop/Delay/Halt	Carrier Drop
U-16	Hold Time for "Delay" Scan	1 ~ 60 Seconds	5 Seconds
U-17	Resume Time after Carrier Drop	0 ~ 10 Seconds	1 Second
U-18	Dual Watch Polling Interval	3 ~ 15 Seconds	10 Seconds
U-19	Scanning Speed	1 ~ 100 ms./Step	10 ms.
U-20	Electronic Keyer Mode	Keyer 1/Keyer 2/Bug	Keyer 1
U-21	Keyer Dot:Space Ratio	0 (0:1) ~ 127 (12.7:1)	10 (1:1)
U-22	Keyer Dash:Space Ratio	0 (0:1) ~ 127 (12.7:1)	30 (3:1)
U-23	Keyer Envelope Delay	0 ~ 30 ms.	5 ms.
U-24	Semi-Break-in PTT Hold Time	0 ~ 5100 ms. (5.1 seconds)	0 ms.
U-25	Contest Number	0000 ~ 9999	0000
U-26	Contest Number "0" Format	0 (Zero)/T/O (Oh)	0 (Zero)
U-27	Contest Number "1" Format	1/A	A
U-28	Contest Number "2" Format	2/U	2
U-29	Contest Number "3" Format	3/V	3
U-30	Contest Number "5" Format	5/E	5
U-31	Contest Number "7" Format	7/B	7
U-32	Contest Number "8" Format	8/D	8
U-33	Contest Number "9" Format	9/N	9
U-34	Contest Number Size/Format	No Leading 0/nnn/nnnn/Off	No Leading 0
U-35	HF Repeater Tone Type	CTCSS/Burst	CTCSS
U-36	VHF Repeater Tone Type	CTCSS/Burst	CTCSS

# Menu Operation

## Menu Mode Summary Chart

Menu #	Function of Menu Item	Available Choices	Default
U-37	(TX) Tone Frequency	Off/67.0 ~ 250.3 Hz/1750 Hz	Off
U-38	(RX) Tone Frequency	Off/67.0 ~ 250.3 Hz	Off
U-39	HF Repeater Shift	0 ~ 5 MHz	100 kHz
U-40	VHF Repeater Shift	0 ~ 5 MHz	500 kHz
U-41	Automatic Antenna Selection	Auto/Manual/Off	Auto
U-42	RTTY Generator Tone Pair	2125/1275 USB/2125/1275 LSB	2125 LSB
U-43	RTTY Shift	170/425/850 Hz	170 Hz
U-44	Shift Polarity	Normal/Reverse	Normal
U-45	Packet Freq. Display Offset	-3.0 ~ +3.0 kHz	+2.125 kHz
U-46	Packet Subcarrier Frequency	1170/1700/2125/2210 USB/LSB	2125 USB
U-47	RF Preamp (Band-by-Band)	JFET/MOSFET	JFET(160-15m)
U-48	ATU Enabling on RX	On/Off	Off
U-49	Max. PO: Antenna-A	100/50/10 W	100 W
U-50	Max. PO: Antenna-B	100/50/10 W	100 W
U-51	DSP Voice Equalizer	Hi/Mid/Low/Bandpass/Off	Off
U-52	Linear Tuning Start	Begins when [Ent] is pressed	
U-53	Linear Tuning PO: Ant. A	100/50/10 W	100 W
U-54	Linear Tuning PO: Ant. B	100/50/10 W	100 W
U-55	Linear Tuning Time	3 ~ 60 Seconds	10 Seconds
U-56	Linear Tuning Space Time	0 ~ 3000 ms.	100 ms.
U-57	Linear Tuning Pulse Time	0 ~ 3000 ms.	100 ms.
U-58	Rx LSB Carrier Offset	-300 ~ +500 Hz	0
U-59	Tx LSB Carrier Offset	-300 ~ +500 Hz	0
U-60	Processor LSB Offset	-300 ~ +500 Hz	0
U-61	Rx USB Carrier Offset	-300 ~ +500 Hz	0
U-62	Tx USB Carrier Offset	-300 ~ +500 Hz	0
U-63	Processor USB Offset	-300 ~ +500 Hz	0
U-64	VOX Hang Time	0 ~ 3 Seconds	1 Second
U-65	VOX Gain	0 ~ 15 (Arbitrary scale)	15
U-66	VOX Anti-Trip	0 ~ 15 (Arbitrary scale)	5
U-67	Quick Menu	All Menu Items	Off
U-68	FM Scanning Steps	Off/0.5 ~ 50 kHz	10 kHz
U-69	CW Filter	On/Off	Off
U-70	AM Filter	On/Off	Off
U-71	ATU Auto-Retuning	On/Off	On
U-72	ATU Fast Tuning	On/Off	Off
U-73	RX Ant. Jack Circuit Path	Open/Connected on Tx	Open

## U-01 ( *DIAL--S* )

**Function:** VFO-A/VFO-B Tuning Dial Speed

**Available Values:** 4/ 2

**Default:** 4

You may choose between two speeds for the tuning dials. Selecting “2” cuts the tuning rate in half compared to the default value.

## U-02 ( *UP/DN--S* )

**Function:** UP/Down Switch Steps (front panel)

**Available Values:** 0.5 ~ 1000 (kHz/Step)

**Default:** 100 kHz/Step

The default value is ideal for quick navigation from one end of a band to the other. For quick tuning around within a band segment, a value like 1 kHz may be preferable.

## U-03 ( *STEPSET* )

**Function:** STEP Switch Function

**Available Values:** Lock/Normal

**Default:** Lock

The Lock position allows toggling of the **Fast** ⇒ **Fine** ⇒ **Normal** tuning rate. If Normal is chosen, you must hold the [STEP] key *in* while the “Fast” or “Fine” indicator is illuminated in order for those tuning rates to be chosen. After releasing the [STEP] key, the tuning rate will return to “Normal.”

## U-04 ( *QSK SPL* )

**Function:** Activation/Setting of Magnitude of Quick Split

**Available Values:** Off or 100 ~ 1000 kHz

**Default:** Off

If the Quick Split Menu Item is set to anything other than Off, pressing the [A ► B] key will put the transceiver in the “Split” mode, with Tx on VFO-B and Rx on VFO-A. Additionally, a frequency offset (referenced to the Rx frequency) will be applied, per your setting of this Menu Item.

## U-05 ( *SPOT--TX* )

**Function:** Activation/De-activation of Tx when the [SPOT] key is pushed

**Available Values:** On/Off

**Default:** Off

Normally, pressing the [SPOT] key only causes you to hear an audible tone corresponding to the pitch of your own transmitted signal (in the CW mode). By setting this Menu Item to On, however, you can also cause the FT-920 to *transmit* when the [SPOT] key is pressed.

## U-06 ( *BEEP--F* )

**Function:** Setting of Key Beeper Frequency

**Available Values:** Off or 220 ~ 7040 Hz

**Default:** 800 Hz

The Menu Item allows you to set the tone of the front panel key Beep tone generator to whatever value is comfortable. It also allows you to disable the Beep tone, if desired.

## U-07 ( *MTR--PH* )

**Function:** Enabling/Disabling of the “Peak-Hold” function of the S/PO meter.

**Available Values:** Off (off) ~ 2000 ms.

**Default:** Off (off)

## U-08 ( *DIMMER* )

**Function:** Adjustment of illumination level for front panel display

**Available Values:** On/Off

**Default:** Off

In low-light situations, activating the Dimmer may reduce excess brightness in the display. For normal room lighting, however, this Menu Item should be set to Off for best visibility.

# Menu Operation

## U-09 ( DISPLAY )

**Function:** Selection of display Multi-Panel characteristics

**Available Values:** [L Rr / P] [h / 0FF5E]t

**Default:** [L Rr

This Menu Item allows you to choose which selection will be displayed in the small Multi Panel, located immediately to the right of the VFO-A frequency display. The choices are:

- [L Rr      Display of the Clarifier offset (in kHz) from the VFO-A frequency.
- P] [h      Display of the CW Pitch (in Hz)
- 0FF5E]t    Display of the amount of frequency difference between VFO-A and VFO-B.

## U-10 ( E--DISPL )

**Function:** Selection of Enhanced Tuning Scale choices

**Available Values:** [L Rr / dSP / tUnE / Fi nE

**Default:** dSP

The Enhanced Tuning Scale, located immediately above the VFO-A frequency display, may be used to provide a visual indication of several transceiver operating characteristics:

- [L Rr      When the Clarifier is active, a small dot below the horizontal Enhanced Tuning Scale shows the relative offset of the Clarifier from the displayed VFO-A frequency. Note that this small dot will be observed on Receive when the Rx Clarifier is on, but only on transmit when the Tx Clarifier is on.
- dSP      When the DSP is On, this scale provides a relative indication of the bandwidth currently set via the High-Cut and Low-Cut knobs.
- tUnE      In this mode, an arrow indicates which direction you should tune on CW in order to center an incoming tone on the "zero beat" point with your own signal.
- Fi nE      When tuning in steps less than 10 Hz, this scale will expand rapidly as you tune quickly, but as you tune slowly you will be able to measure frequency steps as fine as 1 Hz, thanks to the 1 Hz calibration dots on the Enhanced Tuning Scale. This feature will be dis-

abled when tuning steps are 10 Hz or larger.

## U-11 ( GROUP1 )

**Function:** Select the number of Memory Channels in Group 1

**Available Values:** 01 ~ 99

**Default:** 99 (All Memory Channels are in Group 1 by default)

Memory Group 1 may be left at 99 channels, in which case there will be no partitioning of the Memory System. Otherwise, you may set any number less than 99 for inclusion in Group 1 if you wish to partition the memories.

## U-12 ( GROUP2 )

**Function:** Select the number of memories in Group 2

**Available Values:** The last digit in Group 1 *plus 1* is the bottom end of Group 2; 99 maximum

**Default:** 0FF

If, for example, there are 25 memories in Group 1, Group 2 starts at Memory #26.

## U-13 ( GROUP3 )

**Function:** Select the number of memories in Group 3

**Available Values:** The last digit in Group 2 *plus 1* is the bottom end of Group 3; 99 maximum

**Default:** 0FF

If, for example, Group 2 contains Memory Channels 26 through 40, Group 3 begins with Memory #41.

## U-14 ( GROUP4 )

**Function:** Select the number of memories in Group 4

**Available Values:** The last digit in Group 3 *plus 1* is the bottom end of Group 4; 99 maximum

**Default:** 0FF

You do not have to use all 99 memories. Just set the upper limit of this Menu Item to some value less than 99.



## U-15 (SCAN-STOP)

**Function:** Select the desired Scan-Resume mode.

**Available Values:** PAUS/5SEC/STOP

**Default:** PAUS

This Menu Item allows you to select your favorite method of scan-restart after the scanner has stopped on an incoming signal (when the Squelch opens). The choices are:

**PAUS** The scanner will hold until the signal disappears, then will resume after a delay set via Menu Item U-17.

**5SEC** The scanner will hold for a fixed length of time, set via Menu Item U-16, then resume whether or not the other station is still transmitting.

**STOP** The scanner will stop when a signal is received, and will not restart.

## U-16 (PAUSE-T)

**Function:** Set the delay time for scan resumption in the "5SEC" scan condition described in Menu Item U-15.

**Available Values:** 1 ~ 60 Seconds

**Default:** 5 Seconds

This Menu Item defines the length of time the scanner will dwell on a frequency when in the "5 Second" mode, so named after its default value. After the time period set via this Menu Item, the scanner will resume irrespective of the presence or absence of a signal on the current frequency.

## U-17 (SCAN-RES)

**Function:** Set the delay time for scan resumption in the "PAUS" scan condition described in Menu Item U-15.

**Available Values:** 0.0 ~ 10.0 Seconds

**Default:** 1.0 Second

You will generally want to set a fairly short value for this Menu Item, so as not to delay the resumption of scanning after a signal disappears.

## U-18 (DW-TIME)

**Function:** Set the polling interval for the Dual Watch system

**Available Values:** 3 ~ 15 Seconds

**Default:** 10 Seconds

This Menu Item defines the amount of time the Dual Watch system will dwell on VFO-A before checking VFO-B for activity.

## U-19 (SCANSTEP-W)

**Function:** Set the amount of time per synthesizer step in the VFO/PMS Scan modes

**Available Values:** 1 ~ 100 ms (in 1 ms. steps)

**Default:** 10 ms.

Use this Menu item to select the amount of time each step of the synthesizer will be allocated during VFO Scan or PMS operation.

## U-20 (EL-SET)

**Function:** Select the keyer paddle operating mode

**Available Values:** EL 1/BUG/EL 2

**Default:** EL 1

This menu Item allows selection of the preferred keying action of your paddle. The choices available are:

**EL 1** Iambic keying with Automatic Character Spacing disabled.

**BUG** Mechanical "Bug" key emulation. The "dot" paddle contact produces automatically-generated dots, while the "dash" contact produces dashes of a length produced manually.

**EL 2** Iambic keying with Automatic Character Spacing enabled. This selection is best when programming message memories.

## U-21 (DOTSIZE)

**Function:** Set the Dot:Space ratio for the built-in electronic keyer

**Available Values:** 0 ~ 12.7 (0:1 ~ 12.7:1 Dot:Space ratio)

**Default:** 1.0 (corresponds to 1:1 Dot:Space ratio)

Use this Menu item to set the Dot weighting for the internal keyer. It is not recommended that you exceed a value of "12.7" for this setting.

# Menu Operation

## U-22 ( DASH SIZE )

**Function:** Set the Dash:Space ratio for the built-in electronic keyer

**Available Values:** 0 ~ 12.7 (0:1 ~ 12.7:1 Dash:Space ratio)

**Default:** 3.0 (corresponding to 3:1 Dash:Space ratio)

Note that the Dot:Space:Dash ratio, using the default values, is a perfect 1:1:3.

## U-23 ( ENVELOPE DELAY )

**Function:** Provide an envelope delay when using the internal keyer

**Available Values:** 0 ~ 30 ms.

**Default:** 5 ms.

This Menu Item allows shifting of the entire CW transmission string in time, so as to avoid sequencing difficulties with external linear amplifiers, etc. The delay is applied to the entire keyed signal (no truncation on either “make” or “break”) to preserve the full values of weighting set via Menu Items U-21 and U-22.

## U-24 ( KEYR DELAY )

**Function:** Set the pseudo-VOX hang time for transmission during semi-break-in CW

**Available Values:** 0.00 ~ 5.00 Seconds

**Default:** 0

Increasing this value somewhat above its default will allow the FT-920 to stay in the “transmit” mode between word spaces. This function is analogous to the “VOX Delay” function on voice modes.

## U-25 ( MSG-MEM NO )

**Function:** Set the starting value for the Contest Number used by the message memory

**Available Values:** 0000 ~ 9999

**Default:** 0000

If you should get out of sync with the automatic contest number incrementation of the message memory, you may reset the number via this Menu Item. In a contest, this may be a good candidate for assignment to an exclusive “Quick Menu” position.

## U-26 ( 0-FORM )

**Function:** Define the desired truncation for the 0 figure used in contest numbers

**Available Values:** 0 (0: ■ ■ ■ ■ ■ )

o (o: ■ ■ ■ )

t (T: ■ )

**Default:** 0 (0: ■ ■ ■ ■ ■ )

Use this Menu Item to shorten the number “zero” in a contest number.

## U-27 ( 1-FORM )

**Function:** Define the desired truncation for the 1 figure used in contest numbers

**Available Values:** 1 (1: • ■ ■ ■ ■ )

A (A: • ■ )

**Default:** 1 ( • ■ ■ ■ ■ )

Use this Menu Item to shorten the number “one” in a contest number.

## U-28 ( 2-FORM )

**Function:** Define the desired truncation for the 2 figure used in contest numbers

**Available Values:** 2 (2: • • ■ ■ ■ )

U (U: • • ■ )

**Default:** 2 ( • • ■ ■ ■ )

Use this Menu Item to shorten the number “two” in a contest number.

## U-29 ( 3-FORM )

**Function:** Define the desired truncation for the 3 figure used in contest numbers

**Available Values:** 3 (3: • • • ■ ■ )

V (V: • • • ■ )

**Default:** 3 ( • • • ■ ■ )

This truncation is seldom used in contest numbers, as it may cause confusion with the number 4.

## U-30 (5--FORM)

**Function:** Define the desired truncation for the 5 figure used in contest numbers

**Available Values:** 5 (5: • • • • • )  
E (E: • )

**Default:** 5 ( • • • • • )

This truncation is seldom used in incremented contest numbers, although it frequently is used in the truncated form of the "599" signal report, which may be shortened to "ENN" ( • — • — • — • ) ahead of the incremented contest number (001, 002, ...).

## U-31 (7--FORM)

**Function:** Define the desired truncation for the 7 figure used in contest numbers

**Available Values:** 7 (7: — — • • • )  
B (B: — • • • • )

**Default:** 7 ( — — • • • )

This truncation is seldom used in contest numbers, as it may cause confusion with the number 6.

## U-32 (8--FORM)

**Function:** Define the desired truncation for the 8 figure used in contest numbers

**Available Values:** 8 (8: — — — • • • )  
D (D: — • • • )

**Default:** 8 ( — — — • • • )

Use this Menu Item to shorten the number "eight" in a contest number.

## U-33 (9--FORM)

**Function:** Define the desired truncation for the 9 figure used in contest numbers

**Available Values:** 9 (9: — — — — • )  
N (N: — • • )

**Default:** 9 ( — — — — • )

This is perhaps the most-commonly-truncated number used in CW contests.

## U-34 (NR--SIZE)

**Function:** Set the number of digits in a contest number

**Available Values:** 000/999/9999/0FF

**Default:** 000

The default value places a contest number *without leading zeroes* in the contest number message memory location (at the point where "???" is inserted).

The other choices are:

999 A full three-digit contest number, including zeroes. This will switch automatically to four digits after QSO number 999.

9999 A full four-digit contest number, including zeroes. If you reach 9999 QSOs, you probably already won the contest, and can now quit!

0FF In this mode, the contest number generator is disabled.

## U-35 (HF--TONE)

**Function:** Define the type of repeater-access tone to be transmitted on 28 MHz during FM "RPT" operation.

**Available Values:** [ ] [ ] [ ] [ ] / BURST

**Default:** [ ] [ ] [ ] [ ]

The default value causes a tone (set via Menu Item U-37) to be transmitted continuously when the "RPT" FM mode is in use. The BURST option transmits the selected tone for an interval of only 500 milliseconds, and typically only the 1750 Hz tone selection would be applicable for BURST operation.

## U-36 (VHF--TONE)

**Function:** Define the type of repeater-access tone to be transmitted on 50 MHz during FM "RPT" operation.

**Available Values:** [ ] [ ] [ ] [ ] / BURST

**Default:** [ ] [ ] [ ] [ ]

The default value causes a tone (set via Menu Item U-37) to be transmitted continuously when the "RPT" FM mode is in use. The BURST option transmits the selected tone for an interval of only 500 milliseconds, and typically only the 1750 Hz tone selection would be applicable for BURST operation.

# Menu Operation

## U-37 ( TX--T--F )

**Function:** Set the desired repeater access (Tx) tone.

**Available Values:** OFF/Values per chart below/1750 Hz

**Default:** OFF

Use this Menu Item to set the frequency of your encoding tone, used for repeater access in the FM "RPT" mode.

## U-38 ( RX--T--F )

**Function:** Set the desired Tone Decoder frequency for your receiver

**Available Values:** OFF/Values per chart below

**Default:** OFF

Use this Menu Item to set the frequency of your transceiver's CTCSS Decoder, if used. The Decoder is activated by setting this Menu Item to any value other than OFF, and your receiver will be silent on FM/RPT until a matching tone is received (superimposed on the carrier of an incoming signal).

## U-39 ( HF--RPT )

**Function:** Set the desired repeater shift magnitude for 29 MHz operation

**Available Values:** 0.0 ~ 50000.0 kHz

**Default:** 100.0 kHz

This Menu Item sets the 29 MHz shift separately from the 50 MHz shift.

## U-40 ( VHF--RPT )

**Function:** Set the desired repeater shift magnitude for 50 MHz operation

**Available Values:** 0.0 ~ 50000.0 kHz

**Default:** 500.0 kHz

The default shift represents the standard value used in most of the United States.

CTCSS Tone Frequency (Hz)							
67.0	79.7	94.8	110.9	131.8	156.7	186.2	225.7
69.3	82.5	97.4	114.8	136.5	162.2	192.8	233.6
71.9	85.4	100.0	118.8	141.3	167.9	203.5	241.8
74.4	88.5	103.5	123.0	146.2	173.8	210.7	250.3
77.0	91.5	107.2	127.3	151.4	179.9	218.1	

## U-41 ( ANT--SEL )

**Function:** Define the operating function for the [ANTENNA A/B/RX] switch

**Available Values:** ANT a / a n / a F F

**Default:** ANT a

The available choices are:

- ANT a The selection of Antenna-A, Antenna-B, or RX is stored in VFO or Memory registers, so no operator intervention is needed when changing bands or memories insofar as antenna selection is concerned.
- a n The [ANTENNA A/B/RX] switch is functional, but the settings are not stored in VFO or Memory registers. You must manually choose the antenna selection yourself.
- a F F Only Antenna-A is available. There is no path provided to Antenna-B nor the RX-Only antenna.

## U-42 ( RTTY--TN )

**Function:** Select the offset frequency and injection sideband for the "Mark" tone produced by the internal RTTY generator

**Available Values:** H , 2 125U / L a 1275U /  
H , 2 125L / L a 1275L

**Default:** H , 2 125L

The available choices include:

- H , 2 125U The Mark tone is offset 2.125 kHz, USB injection
- L a 1275U The Mark tone is offset 1.275 kHz, USB injection
- H , 2 125L The Mark tone is offset 2.125 kHz, LSB injection
- L a 1275L The Mark tone is offset 1.275 kHz, LSB injection

The Shift tone's frequency is offset from the Mark tone by an amount determined by the next Menu Item, U-43 (RTTY Shift).

## U-43 ( RTTY--SH )

**Function:** Set the desired RTTY Mark-Space frequency shift

**Available Values:** 5F t 170 / 5F t 425 / 5F t 850

**Default:** 5F t 170

This Menu Item determines the amount of shift to be applied from the Mark tone frequency, which was programmed via Menu Item U-42 (RTTY Tones).

## U-44 (SFT--PQL)

**Function:** Define whether Mark or Space shall be the idling (key up) tone

**Available Values:** n0R1 / rE5

**Default:** n0R1

The above abbreviations are defined as:

- |               |                           |
|---------------|---------------------------|
| n0R1 (Normal) | The idling tone is Space. |
| rE5 (Reverse) | The idling tone is Mark.  |

## U-45 (PK--DISP)

**Function:** Define the Packet displayed frequency offset

**Available Values:** -3.000 ~ 3.000 kHz

**Default:** -2.125 kHz

You can have the display show the (suppressed) carrier frequency or the center frequency between the two Packet tones, for example.

## U-46 (PKT--FRQ)

**Function:** Align the transceiver to the frequency of the tone pair defined by the TNC.

**Available Values:** 1170-U/1700-U/2125-U/  
2210-U/1170-L/1700-L/  
2125-L/2210-L

**Default:** 2125-U

The above designations of the available values represent the center frequency of the Packet tone pairs, plus their injection sideband (L=LSB, U=USB).

## U-47 (RF AMP)

**Function:** Determine which receiver input preamplifier is to be used on each band

**Available Values:** R1/R2

**Defaults:** R1 (1.8 ~ 24.49 MHz), R2 (24.5 ~ 54 MHz)

These preamplifier choices allow the user to customize the preamplifier choice for each amateur band. Preamplifier R1 is a Junction FET type, providing superior strong-signal-handling capability, while preamplifier R2 is a Dual-Gate MOS FET, providing best Noise Figure. Note that the total gain of the J-FET amplifier is somewhat lower than for the MOS FET preamp, but on the lower frequency bands the additional gain is not needed.

The gain of the J-FET amplifier rolls off above 30 MHz, as does the gain of the MOS FET amplifier below about 7 MHz; accordingly, we do not recommend these amplifiers be used outside of the recommended frequencies.

## U-48 (ATU--RX)

**Function:** Enable/Disable the use of the Automatic Antenna Tuner in the Receive mode

**Available Values:** ON/OFF

**Default:** OFF

Engaging the Antenna Tuner in the Receive mode helps protect the receiver circuitry from strong out-of-band signals; it acts as an additional bandpass filter ahead of the fixed bandpass networks already protecting the receiver. There is a very slight reduction in sensitivity when this feature is ON, which should prove insignificant in everyday operation.

## U-49 (A--MAXPO)

**Function:** Set the maximum power level for the "A" antenna terminal

**Available Values:** 100/50/10

**Default:** 100

This convenience feature allows you to limit the power applied to the "A" antenna port, in case you wish to excite a low-drive linear amplifier, for example. You may use the other antenna port for full-power operation, of course.

## U-50 (B--MAXPO)

**Function:** Set the maximum power level for the "B" antenna terminal

**Available Values:** 100/50/10

**Default:** 100

This convenience feature allows you to limit the power applied to the "B" antenna port, in case you wish to excite a low-drive linear amplifier, for example. You may use the other antenna port for full-power operation, of course.

# Menu Operation

## U-51 (MIC-EQ)

**Function:** Set the DSP microphone equalization pattern, if desired

**Available Values:** 0FF/1/2/3/4

**Default:** 0FF

This Menu Item allows you to tailor, via the DSP, the audio response of the transceiver to match your voice characteristics. This focuses the *available power* of the transceiver into the frequency spectrum occupied by your voice, thus increasing *useful* power output.

The choices are:

- 0FF This function is disabled.
- 1 Mid- and high-frequency components are enhanced with this setting.
- 2 A high-emphasis response is produced, ideal for pile-up or contest work.
- 3 Both low- and high-emphasis responses are produced.
- 4 A wide bandpass response is produced, emulating a “broadcast” microphone audio characteristic.

The [DSP] key on the front panel does *not* have to be on for this feature to work, as On/Off control is implicit in the menu selections provided. Use the “Monitor” feature to select the audio response most suited for your voice.

## U-52 (LI-TU-5)

**Function:** Activate the Linear Amplifier Tuning pulser

**Available Values:** N/A

**Default:** 0FF

After selecting this Menu Item, pressing the [ENT] key activates the pulser for a time duration established via Menu Item U-55, and the time remaining will count down on the U-52 status screen. The characteristics of the pulser are set via Menu Items U-53 ~ U-57.

This feature may be ideal for inclusion as a “Quick Menu” item.

## U-53 (LI-A-PO)

**Function:** Set the power output for the Linear Amplifier Tuning pulser via Antenna-A

**Available Values:** 100/50/10

**Default:** 100

If you have different amplifiers for different bands, each with unique drive requirements, you may use this setting to define the tune-up power level via the A antenna port.

## U-54 (LI-B-PO)

**Function:** Set the power output for the Linear Amplifier Tuning pulser via Antenna-B

**Available Values:** 100/50/10

**Default:** 100

If you have different amplifiers for different bands, each with unique drive requirements, you may use this setting to define the tune-up power level via the B antenna port.

## U-55 (LI-TIME)

**Function:** Define the duration of the Linear Amplifier Tuning pulser’s tune-up period

**Available Values:** 3 ~ 60 Seconds

**Default:** 10 Seconds

When the [ENT] key is pressed while in Menu Item U-52, a pulsed signal will be transmitted for a number of seconds, after which the transceiver will return to the Receive mode. The tuning time period is set via this Menu Item.

## U-56 (LI-SPACE)

**Function:** Set the length of the spaces between the Tx pulses defined in Menu Item U-57

**Available Values:** 0 ~ 3000 ms.

**Default:** 100 ms.

A lower value set in this Menu Item makes the pulser’s action more closely appear to resemble a continuous “key-down” tone. The duty cycle is lower, though, depending on the pulse length set via Menu Item U-57.

## U-57 (LI-MARK)

**Function:** Set the length of the Tx pulse for the Linear Amplifier Tuning pulser

**Available Values:** 0 ~ 3000 ms.

**Default:** 100 ms.

A lower value set in this Menu Item reduces the duty cycle of the transceiver/amplifier during linear amplifier tune-up.

## U-58 (RLSBCAR)

**Function:** Set the Rx Carrier Point for LSB

**Available Values:** - 0.300 ~ 0.500 kHz

**Default:** 0.000

Changing this value is analogous to rotating the IF SHIFT control, allowing you to preset the frequency response of the receiver during LSB operation. The effect of the adjustment can be heard if you turn the volume up while rotating the VFO-B Tuning Dial to adjust the setting.

## U-59 (TLSBCAR)

**Function:** Set the Tx Carrier Point for LSB

**Available Values:** - 0.300 ~ 0.500 kHz

**Default:** 0.000

This is the same function as that of Menu Item U-58, as applied to your voice response on LSB (Tx). The effect may be difficult to discern, however, depending on the settings of the TX Equalizer via Menu Item U-51.

## U-60 (PROCLSB)

**Function:** Set the Tx Carrier Point for LSB when the Speech Processor is on

**Available Values:** - 0.300 ~ 0.500 kHz

**Default:** 0.000

This is the same function as that of Menu Item U-59, but is applied to your voice response on LSB (Tx) when the Speech Processor is on. Therefore, it is possible to set two different response characteristics for your voice, one for "Processor-On" and one for "Processor Off."

## U-61 (RUSBCAR)

**Function:** Set the Rx Carrier Point for USB

**Available Values:** - 0.300 ~ 0.500 kHz

**Default:** 0.000

Changing this value is analogous to rotating the IF SHIFT control, allowing you to preset the frequency response of the receiver during USB operation. The effect of the adjustment can be heard if you turn the volume up while rotating the VFO-B Tuning Dial to adjust the setting.

## U-62 (TUSBCAR)

**Function:** Set the Tx Carrier Point for USB

**Available Values:** - 0.300 ~ 0.500 kHz

**Default:** 0.000

This is the same function as that of Menu Item U-58, as applied to your voice response on USB (Tx). The effect may be difficult to discern, however, depending on the settings of the TX Equalizer via Menu Item U-51.

## U-63 (PROCUSB)

**Function:** Set the Tx Carrier Point for USB when the Speech Processor is on

**Available Values:** - 0.300 ~ 0.500 kHz

**Default:** 0.000

This is the same function as that of Menu Item U-59, but is applied to your voice response on USB (Tx) when the Speech Processor is on. Therefore, it is possible to set two different response characteristics for your voice, one for "Processor-On" and one for "Processor Off."

## U-64 (VOX-HLY)

**Function:** Set the "hang time" for the VOX circuitry

**Available Values:** 0 ~ 15

**Default:** 5 (Corresponding to 1 second)

The above scale of 1 ~ 15 is in 0.2 second increments, allowing precise setting of the desired VOX recovery time.

## U-65 (VOX-GAIN)

**Function:** Set the gain of the VOX circuitry's input audio detector

**Available Values:** 0 ~ 15

**Default:** 15

The adjustment values are an arbitrary scale. Set the VOX Gain to the level which quickly activates the transmitter, yet does not pick up extraneous noises in your operating room.

### U-66 ( *UX--ANTR* )

**Function:** Set the level of the “Anti-Trip” circuitry of the VOX system

**Available Values:** 0 ~ 15

**Default:** 15

This adjustment scale is also arbitrary. This Menu Item should be set to the point where loud speaker volume does not activate the VOX.

### U-67 ( *Q MENU* )

**Function:** Define which items are to be included in the “Quick Menu” bank

**Available Values:** All Menu Items

**Default:** OFF

After pressing [ENT] while using this Menu Item, rotate the VFO-B Tuning Dial to select the Menu Item to be included/excluded from Quick Menu, then use the front panel [UP▲] or [DOWN▼] key to change the setting for that Menu Item to ON or OFF.

The default setting for this Menu Item is OFF, which means that there is no Quick Menu feature active. When this is the case, a momentary press of the [MENU] key activates “Normal Menu” operation. When one or more items have been designated for “Quick Menu” use, however, a momentary press of [MENU] activates the Quick Menu; pressing and holding [MENU] in for ½ seconds activates “Normal menu” operation in this case.

### U-68 ( *FM STEP* )

**Function:** Set scanning steps/ to be used during FM operation

**Available Values:** 0FF / 0.5 ~ 50 kHz

**Default:** 10 kHz

This Menu Item sets the scanning steps for FM work when the “FAST” synthesizer-step mode is selected. It allows the radio to be used in a “channelized” mode according to the channel spacing utilized in your country.

### U-69 ( *CW--NRR* )

**Function:** Enable/Disable the signal path through the optional YF-116C CW filter

**Available Values:** 00 / 0FF

**Default:** 0FF

When the CW filter is installed, the signal path must be enabled (or the FT-920 will not “know” that the filter is there). Conversely, if the filter is not installed, erroneously setting this Menu Item to “00” will result in a “dead” receiver if the [NARROW] key is pressed during CW operation.

### U-70 ( *AM--WIDE* )

**Function:** Enable/Disable the signal path through the optional YF-116A AM filter

**Available Values:** 00 / 0FF

**Default:** 0FF

When the AM filter is installed, the signal path must be enabled (or the FT-920 will not “know” that the filter is there). Set this Menu Item to “00” to enable the signal path to the Wide filter. The stock 2.4 kHz (SSB) filter then becomes the “Narrow” filter during AM operation.

### U-71 ( *AUTOTUN* )

**Function:** Enable/Disable automatic retuning of ATU settings when SWR increases

**Available Values:** 00 / 0FF

**Default:** 00

This feature instructs the Automatic Antenna Tuner to re-adjust its settings, without operator intervention, should the SWR present at the antenna jack increase above a value of 3:1.

### U-72 ( *FASTTUN* )

**Function:** Enable/Disable high-speed antenna tuning

**Available Values:** 00 / 0FF

**Default:** 0FF

The higher-speed tuning option reduces the tuning time slightly for the ATU. The SWR obtained at the completion of “Fast” tuning may be slightly higher than in the “Normal” mode, but this should present no problems in typical operation.



## U-73 ( T-RX ANT )

**Function:** Enable/Disable protection relay in line from "RX ANTENNA" jack

**Available Values:** ON/OFF

**Default:** ON

When the [RX ANTENNA] key is pressed, activating the Receive-only antenna port, protection for the receiver circuits from high RF voltage is afforded by a small relay which, in the default condition, opens the RX Antenna line during transmission. If only very low RF voltage is present in your installation during transmission, this Menu Item may be turned OFF.

# VHF/UHF Transverter Operation

Although the FT-920 does not have a dedicated “Transverter” jack *per se*, the flexibility provided by the multiple antenna ports and the Menu system will generally provide easy interfacing to VHF and UHF transverters.

The recommended interconnection points are described below:

- ❑ For transceive converters (where both transmit and receive converter circuits use a common RF input/output line), connect the coaxial cable from the transverter to the [B] antenna jack.
- ❑ For separate receive and transmit converter units, connect the transmit converter’s coaxial cable to the [B] antenna jack, and the receive converter’s coaxial cable to the [Rx ANT IN] RCA jack on the rear panel of the FT-920.
- ❑ Select Antenna-B by pressing the [ANTENNA A/B] switch, if needed.
- ❑ Press VFO-A’s Orange “Tx” LED/Switch for ½ second to activate the “TX Mute” mode, which provides a maximum power output of 10 Watts.
- ❑ Now rotate the **RF PWR** control fully counter-clockwise. At this setting, power output will be essentially zero, and you may then adjust the **RF PWR** control slightly clockwise so as to **Important Note:** Even though you might mistakenly assign a different band to Antenna B, or forget to turn the **RF PWR** control fully counter-clockwise, the maximum power which will appear at the Antenna B port will be 10 watts. If you design an input protection attenuator network correctly, you should easily be able to provide “fail-safe” protection for your VHF/UHF transverter.

# Phone Patch Operation

## Overview

Phone patch operation allows linking your FT-920 to the public telephone system to provide two-way simplex communications on behalf of third parties. The FT-920 may be used with the LL-7 phone patch unit installed in the optional SP-8 external loudspeaker, or with phone patch units from other manufacturers. The diagram at the bottom of the page shows interconnection for the SP-8/LL-7 combination; be sure to consult the documentation provided with units of non-Yaesu manufacture for installation instructions.

## Operation

Phone patch Tx/Rx switching may be done manually using the PTT method, or automatically using the VOX circuitry of the transceiver. While the manual ("PTT") method does not require careful balancing of the LL-7's bridge circuit, it *does* require more work by the operator (you must manually switch the PTT or MOX switch every time someone in the patched conversation says "Over"). Therefore, most operators prefer to use the VOX method whenever the telephone signal-to-noise ratio permits. If the telephone line noise level is high, however, the PTT method may still be necessary, so you should become familiar with both methods.

## Note

You may need to contact your telephone company for permission to connect an external device, such as a phone patch, to the telephone system's lines. Also, you should procure and use a suitable 600  $\Omega$ , three-way transformer if connecting the LL-7 and a telephone handset to the same telephone line.

Regardless of which patch Tx/Rx control method is used, you may need to instruct the person on the telephone to speak slowly in a clear, steady voice level, and to say "Over" when a response is expected from the other party. This will serve as a notice to you (if you are using PTT control) to switch to receive while signaling the other station to go ahead and transmit, so as to avoid "doubling" with the other station.

During all phone patch operation, you should monitor both sides of the conversation at all times (this may be required by law); this will, of course, require a telephone at the operating position.

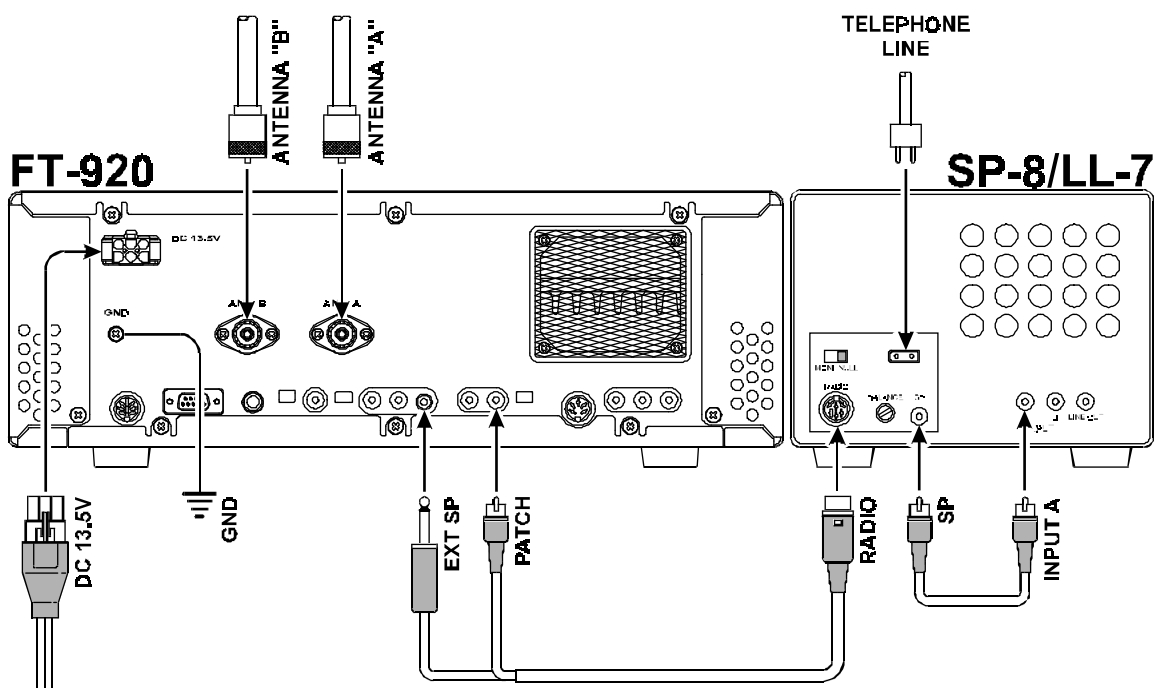

# CAT (Computer-Aided Transceiver) System Protocol

The **CAT** System in the FT-920 provides control of frequency, VFO, memory, and other settings through the use of command codes sent from an external personal computer. This allows multiple control operations to be fully automated as a single mouse click, or it allows a third-party software package (such as contest logging software) to communicate with the FT-920 without operator intervention.

The FT-920 has a built-in level converter, allowing direct connection from the rear panel **CAT** jack to the serial port of your computer, without the need for an external RS-232C level converter box.

You will need a serial cable for connection to the (RS-232C) COM port of your computer. Purchase or construct a standard serial cable (not the so-called "null modem" type), ensuring it has the correct gender and number of pins for connection to your system.

Yaesu Musen does not produce **CAT** System operating software, due to the wide variety of personal computers, operating systems, and applications in use today. However, the FT-920 (and other Yaesu products) are widely supported by third-party software packages, and we recommend that you contact your dealer for advice, or check advertisements in amateur radio journals. Most software vendors also have Home Pages on the World Wide Web containing a wealth of information on the features and radio support for their software packages.

The information presented in this section will allow the programmer to understand the command structure and opcodes used in the FT-920's **CAT** System.

## Opcode Command Chart

#	Command Title	Opcode	Parameter				Comments
1	SPLIT On/Off	01H	P1	xx	xx	xx	P1=00: Off, P1=01: On
2	Recall Memory	02H	P1	xx	xx	xx	See Note 1
3	Memory Operations	03H	P1	P2	xx	xx	See Note 2
4	Recall VFO	05H	P1	xx	xx	xx	P1=00: VFO-A, P1=01: VFO-B
5	Copy Memory Data to VFO-A	06H	P1	xx	xx	xx	See Note 3
6	Clarifier Operations	09H	P1	P2	P3	P4	See Note 4
7	Set VFO-A Frequency	0AH	P1	P2	P3	P4	See Note 5
8	Mode Setting	0CH	P1	xx	xx	xx	See Note 6
9	Update IntervalPacing	0EH	P1	xx	xx	xx	P=00- FF(H) in 1 ms. steps. Adds delay between each byte of all downloaded data from the FT-920
10	Status Update	10H	P1	xx	xx	P4	See Note 7
11	Keyer Commands	70H	1B	01	P3	xx	See Note 8
12	Tuner On/Off	81H	P1	xx	xx	xx	P1=00: Off, P1=01: On
13	Tuner Start	82H	xx	xx	xx	xx	
14	Repeater Shift	84H	P1	xx	xx	xx	P1=00: SIMPLEX, P1=01: Minus Shift, P1=02: Plus Shift
15	Set VFO-B Frequency	8AH	P1	P2	P3	P4	See Note 9
16	Bandwidth	8CH	P1	xx	xx	P4	See Note 10
17	Tone Frequency	90H	P1	P2	xx	xx	See Note 11
18	Read Meter	F7H	P1	xx	xx	xx	See Note 12
19	Read Status Flags	FAH	01	xx	xx	xx	

# CAT (Computer-Aided Transceiver) System Protocol

## Notes to Opcode Command Chart

### Note 1:

P1 = 01~7A: Memory Channel Number (Hex)  
 01~63: Memory Channels 1-01~1-99  
 64~6D: Memory Channels d-01~d-10  
 6E~78: Memory Channels C-01~C-11  
 79~7A: Memory Channels P-Lo~P-Hi

### Note 2:

P1 = 01~7A: Memory Channel Number (Hex)  
 01~63: Memory Channels 1-01~1-99  
 64~6D: Memory Channels d-01~d-10  
 6E~78: Memory Channels C-01~C-11  
 79~7A: Memory Channels P-Lo~P-Hi

P2 = 00: Memory Store  
 P2 = 01: Memory Clear  
 P2 = 02: Memory Recall

### Note 3:

P1 = 01~7A: Memory Channel Number (Hex)  
 01~63: Memory Channels 1-01~1-99  
 64~6D: Memory Channels d-01~d-10  
 6E~78: Memory Channels C-01~C-11  
 79~7A: Memory Channels P-Lo~P-Hi

### Note 4:

P1 = 00: RX Clarifier Off  
 P1 = 01: RX Clarifier On  
 P1 = 80: TX Clarifier Off  
 P1 = 81: TX Clarifier On  
 P1 = FF: Set Clarifier

P2 = 00: Clarifier Offset (+)  
 P2 = FF: Clarifier Offset (-)

P3 = 00~09 (kHz)  
 P4 = 00~00 (100/10 Hz)

### Note 5:

The frequency is converted to its BCD-coded components.  
 For example: to convert 14.256.78 MHz

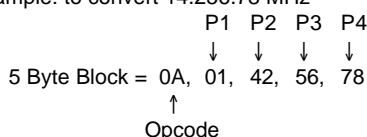

### Note 6:

VFO-A Mode Parameters	VFO-B Mode Parameters
P1 = 00: LSB	P1 = 80: LSB
P1 = 01: USB	P1 = 81: USB
P1 = 02: CW-USB	P1 = 82: CW-USB
P1 = 03: CW-LSB	P1 = 83: CW-LSB
P1 = 04: AM	P1 = 84: AM
P1 = 05: AM	P1 = 85: AM
P1 = 06: FM	P1 = 86: FM
P1 = 07: FM-N	P1 = 87: FM-N
P1 = 08: DATA-LSB	P1 = 88: DATA-LSB
P1 = 09: DATA-LSB	P1 = 89: DATA-LSB
P1 = 0A: DATA-USB	P1 = 8A: DATA-USB
P1 = 0B: DATA-FM	P1 = 8B: DATA-FM

### Note 7:

#### Status Update Data

P1 = 01: Memory Channel Number (1 byte)  
 P1 = 02: Current Operating Data for VFO/Memory (28 bytes)  
 P1 = 03: VFO-A and VFO-B Data (28 bytes)  
 P1 = 04: Memory Channel Data: (14 bytes)

P4 = 01~89 Memory Channel Number (used when P1 = 04)  
 01~63: Memory Channels 1-01~1-99  
 64~6D: Memory Channels d-01~d-10 (VFO-A)  
 6E~78: Memory Channels C-01~C-11  
 79~7A: Memory Channels P-Lo~P-Hi  
 7B~84: Memory Channels d-01~d-10 (VFO-B)  
 85~89: QMB Memories S-01~S-05

### Note 8:

P3 = 00: Keyer Memory 0  
 P3 = 01: Keyer Memory 1  
 P3 = 02: Keyer Memory 2  
 P3 = 03: Keyer Memory 3  
 P3 = 04: "ID" Memory  
 P3 = 05: "Contest Number" Memory  
 P3 = 06: Keyer Memory Down  
 P3 = 07: Keyer Memory Up  
 P3 = 08: Keyer Memory Playback (no Tx)  
 P3 = 09: Write Memory

### Note 9:

The frequency is converted to its BCD-coded components.  
 For example: to convert 14.256.78 MHz

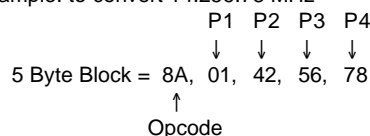

### Note 10:

VFO-A Mode Parameters	VFO-B Mode Parameters
P1 = 00: Wide	P1 = 80: Wide
P1 = 01: Wide	P1 = 81: Wide
P1 = 02: Narrow	P1 = 82: Narrow
P1 = 03: Narrow	P1 = 83: Narrow
P1 = 04: Wide	P1 = 84: Wide

### Note 11:

P1 = 00~28: Tone Encoder Frequency (Hex)  
 P2 = 00~27: Tone Decoder Frequency (Hex)

### Note 12:

A digitized meter deflection indication is returned, with value between 0 and FFH; four sets of this data are sent, plus one padding byte (0F7H), as follows:

Meter Byte	Meter Byte	Meter Byte	Meter Byte	F7H
------------	------------	------------	------------	-----

P1 = 00: S/PO, ALC, VOLT, AMP  
 P1 = 01: FWD, REV, SHIFT, PITCH  
 P1 = 02: Dummy byte, SQL, HPF, LPF  
 P1 = 03: NR, PROC, DISC, RMC

### CTCSS Tone Data

P1 P2	Freq. (Hz)	P1 P2	Freq. (Hz)	P1 P2	Freq. (Hz)	P1 P2	Freq. (Hz)
00h	OFF	0Bh	94.8	16h	136.5	21h	203.5
01h	67.0	0Ch	97.4	17h	141.3	22h	210.7
02h	69.3	0Dh	100.0	18h	146.2	23h	218.1
03h	71.9	0Eh	103.5	19h	151.4	24h	225.7
04h	74.4	0Fh	107.2	1Ah	156.7	25h	233.6
05h	77.0	10h	110.9	1Bh	162.2	26h	241.8
06h	79.7	11h	114.8	1Ch	167.9	27h	250.3
07h	82.5	12h	118.8	1Dh	173.8	28h*	1750
08h	85.4	13h	123.0	1Eh	179.9		
09h	88.5	14h	127.3	1Fh	186.2		
0Ah	91.5	15h	131.8	20h	192.8		* 28h = P1 only

# CAT (Computer-Aided Transceiver) System Protocol

## CAT Data Protocol

Serial data is passed via the **CAT** jack on the rear panel of the transceiver at 4800 bps. When data is being transferred, the **CAT** indicator on the front panel display is illuminated momentarily, disappearing when the data flow is terminated. All commands sent from the computer to the transceiver consist of five-byte blocs, with up to 200 ms between each byte. The last byte in each block is the **instruction opcode**, while the first four bytes of each block are arguments (either parameters for that instruction, or dummy values required to pad the block out to five bytes).

Byte 1	Byte 2	Byte 3	Byte 4	Byte 5
Argument	Argument	Argument	Argument	Instruction OPCODE
CAT 5-BYTE COMMAND STRUCTIURE				

Each byte sent consists of one start bit, 8 data bits, no parity bit, and two stop bits:

Start Bit	0	1	2	3	4	5	6	7	Stop Bit	Stop Bit
CAT DATA BYTE FORMAT										

There are nineteen instruction opcodes for the FT-920, listed in the chart on page 86. Most of these duplicate front panel operations, while some replicate Menu functions. Note that most commands require one or more parameters to be set; however, regardless of the number of parameters present, every Command Block sent *must* consist of five bytes.

Accordingly, any **CAT** control program must construct the five-byte block by selecting the appropriate instruction opcode, organizing the parameters, if any, and providing unused "dummy" argument bytes to pad the block to its required five-byte length (the dummy bytes can contain any value). The resulting five bytes are then sent, *opcode last*, from the computer to the FT-920 CPU via the computer's serial port and the transceiver's **CAT** jack.

## Constructing and Sending CAT Commands

### Example #1:

Set VFO-A to 14.250.00 MHz

- Per the CAT Command Table, the opcode for "Set VFO-A Frequency" is "0AH." Note that the "H" following each byte value indicate hexadecimal (base 16) values. Placing the opcode into the fifth data bit position, we then enter the frequency into the first four data bit positions:

10's Hz	100's Hz	1's kHz	10's kHz	100's kHz	1's MHz	10's MHz	100's MHz
0	0	0	5	2	4	1	0
00		50		42		01	
Byte 1		Byte 2		Byte 3		Byte 4	

The four argument byte values are constructed from the decimal value by breaking the frequency into 2-digit blocks (in BCD "packed decimal" format). Leading zeroes **are required** in the hundreds-of-MHz place as well as the tens-of-MHz place (when below 10 MHz).

- We now insert the four-byte BCD-coded frequency (00, 50, 42, 01) into the five-byte block along with the parameter byte, resulting in a complete command string in hex format:

Byte 1	Byte 2	Byte 3	Byte 4	Byte 5
00	50	42	01	0AH
Data/Argument Bytes				Opcode

Send these five bytes to the transceiver, in the order shown in the table above, left to right: 00 50 42 01 0AH

### Example #2:

Store the above frequency (14.250 MHz) into Memory Channel #1-48

- Memory operation is exercised by Opcode 03H. In base 16 (hexadecimal), Memory Channel #48 is channel 30. And, pursuant to Note #2 associated with Opcode 03H, parameter P2 (Memory Set) must be set to value "00." Therefore, the corresponding five-byte command/parameter block would be 00 00 00 30 03H.

Byte 1	Byte 2	Byte 3	Byte 4	Byte 5
00	00	00	30	03H
Data/Argument Bytes				Opcode

In sum, commands are sent in the following general format:

Byte 1	Byte 2	Byte 3	Byte 4	Byte 5
P4	P3	P2	P1	Opcode

# CAT (Computer-Aided Transceiver) System Protocol

## Downloading FT-920 Data

On command, the FT-920 will download some or all of its operational data. By regular polling of the transceiver, your software can be kept continuously updated on the status of the FT-920 operating environment.

The following commands cause the FT-920 to download various components of its operational status:

**Status Update (10H):** this Opcode causes the transceiver to download frequency and memory channel data, per the parameter data supplied in the Status Update request (parameters P1 & P4).

**Status Flags Request (FAH):** this Opcode instructs the transceiver to download eight status flag bytes.

**Read Meter (F7H):** this Opcode causes the transceiver to download meter deflection data in packs, pursuant to Note 12 following the "Opcode Command Chart on page 86.

**Pacing (0EH):** this Opcode sets the delay between bytes of data when you request a download of data. This delay is set to zero initially, but resetting it to a higher value will allow slower computers to read and process data returned by the radio. However, the download time will be significantly increased if a high value is used in this command's "P1" argument.

These Opcodes are detailed below.

### Status Update (10H)

Depending on the value of parameter P1, this command will return:

- One byte containing the current Memory Channel Number (P1=01);
- Two 14-byte records of the current operating frequency (VFO or Memory; P1=02);
- One each 14-byte record for VFO-A and VFO-B (P1=03); or
- One 14-byte record of Memory Channel data (P1=04).

When P1 is set to value 04, parameter P4 may be set to a hexadecimal value between 00 and 89 to prompt the transceiver to download frequency information on any of the memories, as shown in Note 7 on previous page. So P1=04 instructs the radio to download memory data, and P4's value defines which memory channel's data is to be downloaded.

The format for the 14-byte frequency data records is shown at the end of this sub-section.

### Status Flags Request (FAH)

The format for the eight Status Flags is shown below:

## 8-Byte Status Flags Record Table

Bit Offset	Status Flag Byte #0 Contents
0	Split Operation active with VFO-B on TX
1	Split Operation active with VFO-B on RX
2	Antenna Tuner On/tuning
3	CAT System operation in progress
4	VFO-B In Use (both TX and RX on VFO-B)
5	Direct Keypad Entry in progress
6	VFO-A is Muted
7	Transmission in progress (PTT line grounded)

Bit Offset	Status Flag Byte #1 Contents
0	5-second "Memory Check" countdown in progress
1	Memory Checking in progress
2	Dual VFO Tracking active
3	Quick Memory Bank (QMB) selected
4	Memory Tuning in progress
5	VFO Operation selected
6	Memory Mode selected
7	General Coverage Reception active

Bit Offset	Status Flag Byte #2 Contents
0	Fast Tuning is active
1	Antenna Tuner is in-line
2	VFO-B is locked
3	VFO-A is locked
4	Squelch is closed
5	Up scanning is active
6	Scanning is paused
7	Scanning is active

Bit Offset	Status Flag Byte #3 Contents
0	Not Used
1	Alpha-Numeric Memory Level selected
2	Not Used
3	Linear Amplifier Tuning Pulser active
4	PTT grounded via CAT command
5	Transmit "Inhibit" is active
6	Key Release Timer active
7	PTT inhibit

Bit Offset	Status Flag Byte #4 Contents
0	RTTY space (TX Idle)
1	Not Used
2	All Front Panel Controls locked
3	Group Memory Mode active
4	Antenna B selected
5	Rx Antenna selected
6	Not Used
7	Not Used

Bit Offset	Status Flag Byte #5 Contents
0	VFO-A is muted
1	VFO-B is muted
2	Not Used
3	Tx activated via Spot switch command
4	Not Used
5	Not Used
6	Antenna Tuner's Wait light is on
7	High SWR detected

Bit Offset	Status Flag Byte #6 Contents
0	Dual Watch active
1	Not Used
2	Quick Menu Mode active
3	BUSY lamp is on
4	Fine Tuning active
5	Not Used
6	VFO-B Tx Mute active
7	VFO-A Tx Mute active

Bit Offset	Status Flag Byte #7 Contents
0	Not Used
1	Menu Setting in progress
2	CTCSS/Tone Burst active
3	Not Used
4	Not Used
5	Linear Amplifier Tuning Pulse being transmitted
6	DTMF Tone are being transmitted
7	VOX is active

# CAT (Computer-Aided Transceiver) System Protocol

## Read Meter (F7H)

Sending this command with the parameters shown below causes a variety of transceiver metering data to be downloaded. The values are within the range 0 and FFH, and the data is returned in the following format:

Parameter	Meter Byte	Meter Byte	Meter Byte	Meter Byte	Pad
P1 = 00	S/PO	ALC	VOLT	AMP	F7H
P1 = 01	FWD	REV	SHIFT	PITCH	F7H
P1 = 02	Dummy	SQL	HPF	LPF	F7H
P1 = 03	NR	PROC	DISC	RMC	F7H

The "dummy" data above is meaningless, and may be ignored.

## 1-Byte Memory Channel Number

Data Structure (For Opcode 10H, etc.)

Memory Channel Data (Hex Codes)							
Ch.	Hex	Ch.	Hex	Ch.	Hex	Ch.	Hex
1-01	01H	1-32	20H	1-63	3FH	1-94	5EH
1-02	02H	1-33	21H	1-64	40H	1-95	5FH
1-03	03H	1-34	22H	1-65	41H	1-96	60H
1-04	04H	1-35	23H	1-66	42H	1-97	61H
1-05	05H	1-36	24H	1-67	43H	1-98	62H
1-06	06H	1-37	25H	1-68	44H	1-99	63H
1-07	07H	1-38	26H	1-69	45H	d-01	64H
1-08	08H	1-39	27H	1-70	46H	d-02	65H
1-09	09H	1-40	28H	1-71	47H	d-03	66H
1-10	0AH	1-41	29H	1-72	48H	d-04	67H
1-11	0BH	1-42	2AH	1-73	49H	d-05	68H
1-12	0CH	1-43	2BH	1-74	4AH	d-06	69H
1-13	0DH	1-44	2CH	1-75	4BH	d-07	6AH
1-14	0EH	1-45	2DH	1-76	4CH	d-08	6BH
1-15	0FH	1-46	2EH	1-77	4DH	d-09	6CH
1-16	10H	1-47	2FH	1-78	4EH	d-10	6DH
1-17	11H	1-48	30H	1-79	4FH	C-01	6EH
1-18	12H	1-49	31H	1-80	50H	C-02	6FH
1-19	13H	1-50	32H	1-81	51H	C-03	70H
1-20	14H	1-51	33H	1-82	52H	C-04	71H
1-21	15H	1-52	34H	1-83	53H	C-05	72H
1-22	16H	1-53	35H	1-84	54H	C-06	73H
1-23	17H	1-54	36H	1-85	55H	C-07	74H
1-24	18H	1-55	37H	1-86	56H	C-08	75H
1-25	19H	1-56	38H	1-87	57H	C-09	76H
1-26	1AH	1-57	39H	1-88	58H	C-10	77H
1-27	1BH	1-58	3AH	1-89	59H	C-11	78H
1-28	1CH	1-59	3BH	1-90	5AH	P-Lo	79H
1-29	1DH	1-60	3CH	1-91	5BH	P-Hi	7AH
1-30	1EH	1-61	3DH	1-92	5CH		
1-31	1FH	1-62	3EH	1-93	5DH		

## Tone Frequency Codes

P1 P2	Freq. (Hz)	P1 P2	Freq. (Hz)	P1 P2	Freq. (Hz)	P1 P2	Freq. (Hz)	P1 P2	Freq. (Hz)
00h	OFF	09h	88.5	12h	118.8	1Bh	162.2	24h	225.7
01h	67.0	0Ah	91.5	13h	123.0	1Ch	167.9	25h	233.6
02h	69.3	0Bh	94.8	14h	127.3	1Dh	173.8	26h	241.8
03h	71.9	0Ch	97.4	15h	131.8	1Eh	179.9	27h	250.3
04h	74.4	0Dh	100.0	16h	136.5	1Fh	186.2	28h*	1750
05h	77.0	0Eh	103.5	17h	141.3	20h	192.8		
06h	79.7	0Fh	107.2	18h	146.2	21h	203.5		
07h	82.5	10h	110.9	19h	151.4	22h	210.7		
08h	85.4	11h	114.8	1Ah	156.7	23h	218.1		

\* 28h = P1 only

## 14-Byte Frequency Data

### Record Structure

The following tables outline the 14-byte data record structures used for the Operating Data, VFO-A, VFO-B, and Memory Frequency data records.

Byte	14-Byte Data Record Assignment
1	Band Selection
2	Operating Frequency
3	
4	
5	
6	Clarifier Offset (2 Bytes, see below)
7	
8	Mode Data
9	Flag
A	Filter Data 1
B	Filter Data 2
C	CTCSS Encoder Data
D	CTCSS Decoder Data
E	Memory Recall Flag

### FREQ DATA

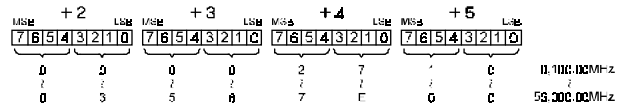

### CLAR DATA

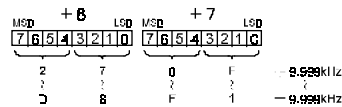

### MODE DATA

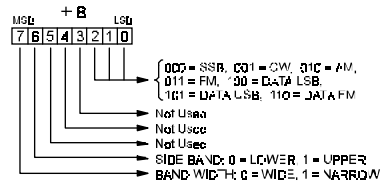

### FLAG

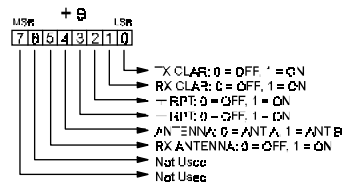

### FILTER DATA 1

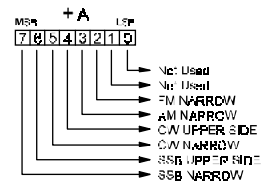

### FILTER DATA 2

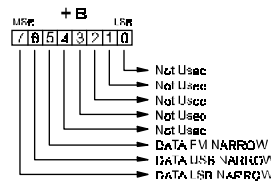

### MR FLAG

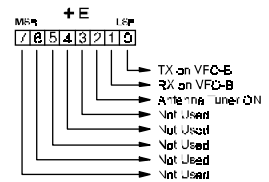



# Memory Backup

The FT-920's memory data is maintained, even when DC power is turned off, via a lithium backup battery with an estimated lifetime of approximately five years. No data essential to the fundamental operation of the radio is stored in "volatile" memory, so when the battery's voltage ultimately is exhausted the transceiver will not be disabled; you will just observe that your memories have disappeared.

In some cases of erratic operation, it may be advisable to reset the microprocessor to its factory default condition, so as to determine whether or not a part failure has caused improper action, as opposed to some operational error.

This section describes the procedures to be used for these situations.

## Backup Battery Replacement

The backup battery is a standard Sony™ CR2032 (or equivalent), which is installed in a socket on the bottom side of the transceiver. Replacement of the battery is easy to accomplish:

- ① Remove the bottom cover of the transceiver (see page 93).
- ② Locate the backup battery, per the illustration, located near the front panel in the vicinity of the bright silver enclosure on the left side. Remove the original backup battery, and replace it with a fresh one (be sure the replacement battery shows at least 3 Volts on a Voltmeter).
- ③ Before closing the case, be certain to check that you have not accidentally changed the position of the **BACKUP** switch, located near the backup battery but immediately adjacent to the above-referenced silver enclosure. This switch must be in the **ON** position for the backup system to work.
- ④ Close up the case, replacing the six screws on the bottom, then tightening the four screws on the side panels. Be careful not to pinch any wires while re-assembling the radio.

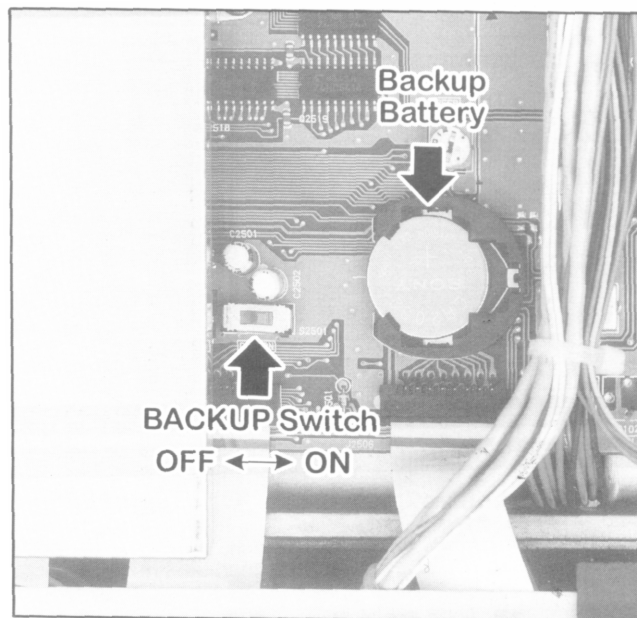

# Microprocessor Resetting

## Microprocessor Reset Procedures

Three levels of microprocessor resetting are available, only two of which are typically used. These are:

- A reset of all memories, antenna tuner data, and VFO frequencies to their factory defaults. Menu settings are *not* affected by this procedure. To do this, turn the transceiver off, then press and hold in the [GEN] and [ENT] keys on the keyboard *and hold them in while you turn the [POWER] switch back on*. The VFO-B frequency display area will indicate "INITIAL" and a series of "Dashes" will slowly disappear across the middle of the VFO-A frequency display area. When the initialization procedure is complete, the frequency displays, newly reset to 7.000 MHz in the LSB mode, will reappear.
- A reset of just the Menu settings is also possible. This will not wipe out any other memories, but will allow you to clear all Menu settings to their original factory default values. To do this, turn the trans-

ceiver off., then press and hold in the [MENU] and [CLEAR CLAR] keys *and hold them in while you turn the [POWER] switch back on*.

- If the transceiver's microprocessor still is behaving erratically, you may need to perform a complete, "hard" reset of the CPU. To do this, remove the bottom cover of the transceiver as described previously. Now set the **BACKUP** switch to the **OFF** position. Wait about 30 seconds, then plug the DC cable back into the rear panel DC jack. Turn the transceiver on, then carefully turn the **BACKUP** switch on using a non-conducting alignment tool or a toothpick. The transceiver may now be turned off, the DC cable removed, and the bottom cover replaced.

### **Important Note!**

Be extremely careful not to come in contact with any transceiver internal circuitry while the bottom case is removed, as possibly dangerous voltages may exist inside the case.

# Installation of Optional Accessories

## Bottom Case Removal

- ① Turn the transceiver off, and remove all cables connected to it.
- ② Turn the transceiver upside down, and remove the six screws affixing the bottom panel of the radio. Loosen the four screws on the sides of the upper case, but do not remove them.
- ③ Now fold the rear of the bottom panel slightly away from the chassis, and remove the bottom panel by sliding it rearward.
- ④ To close up the case, replace the six screws on the bottom, then tighten the four screws on the side panels. Be careful not to pinch any wires while re-assembling the radio.

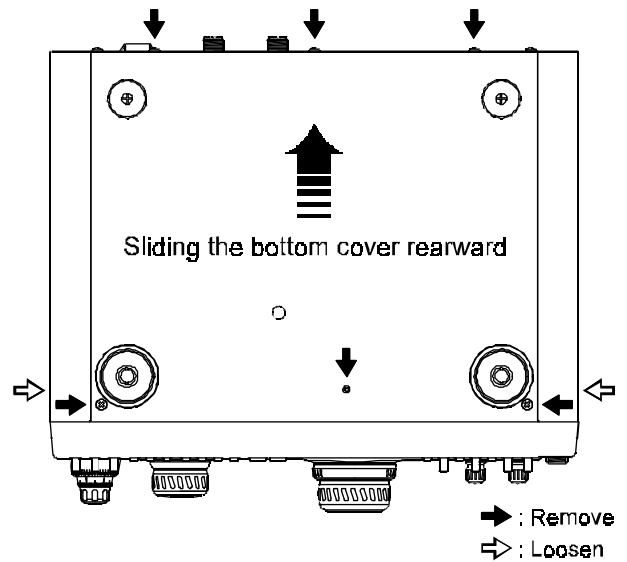

Figure 1

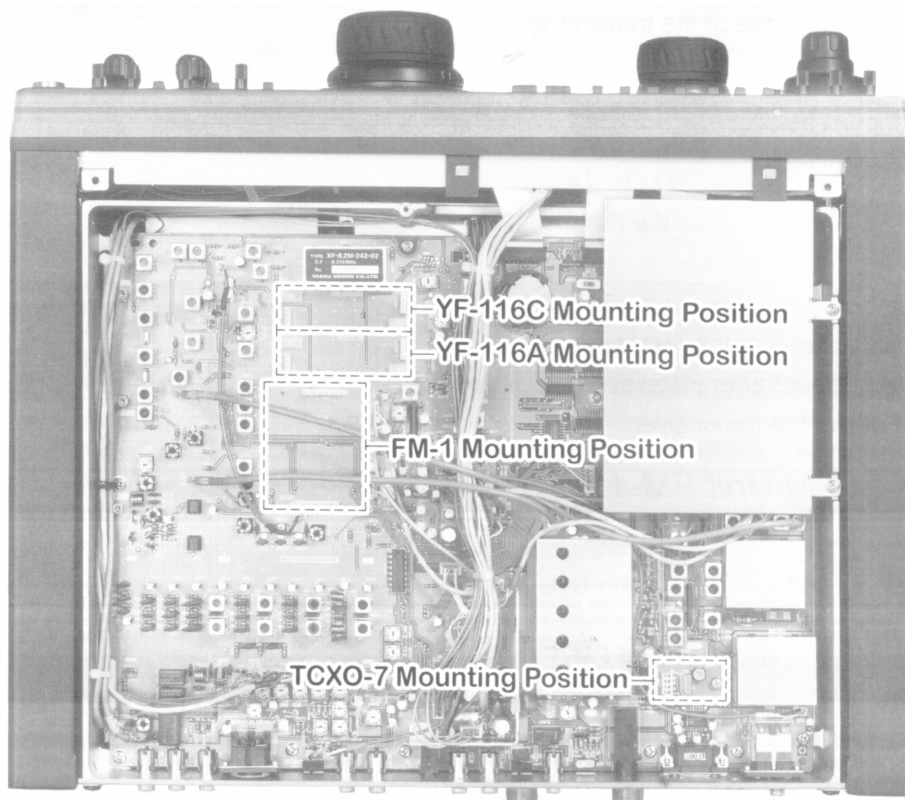

Figure 2

# Installation of Optional Accessories

## Installation of

### Optional Filters YF-116C/YF-116A

- ① Remove the bottom case of the transceiver (see previous page).
- ② Refer to Figure 2 on the previous page, and locate the mounting positions for the CW (**YF-116C**) and/or AM (**YF-116A**) filters on the MAIN Unit.
- ③ Refer to Figure 3, and push the optional filter board onto the pins corresponding to its assigned mounting location on the radio. Gently press the board down until it is firmly seated in its connectors.
- ④ Replace the bottom case of the transceiver.
- ⑤ Turn the transceiver on, and enter the Menu mode. Per the chart below, change the setting of Menu Item U-69 to **"On"** if installing the **YF-116C** CW filter, and/or change the setting of Menu Item U-70 to **"On"** if installing the **YF-116A** AM filter.
- ⑥ Filter installation is now complete.

## Installation of

### High-Stability Oscillator TCXO-7

- ① Remove the bottom case of the transceiver (see previous page).
- ② Refer to Figure 2 on the previous page, and locate the mounting position for the **TCXO-7**, which currently is occupied by the "REF OSC UNIT."
- ③ Refer to Figure 4, and remove the REF OSC UNIT, replacing it with the **TCXO-7**.
- ④ Installation is now complete, as the **TCXO-7** has been carefully aligned at the factory and should require no adjustment after installation. Replace the bottom case of the transceiver.

## Installation of FM Unit FM-1

- ① Remove the bottom case of the transceiver (see previous page).
- ② Refer to Figure 2 on the previous page, and locate the mounting positions for the **FM-1** on the MAIN Unit.
- ③ Refer to Figure 5, and push the optional **FM-1** board onto the pins corresponding to its assigned mounting location on the radio. Gently press the board down until it is firmly seated in its connectors.
- ④ Installation is now complete, as the **FM-1** has been carefully aligned at the factory and should require no adjustment after installation. Replace the bottom case of the transceiver.

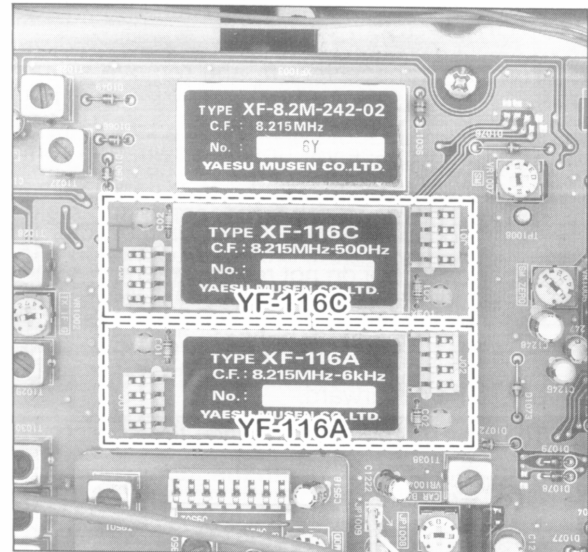

Figure 3

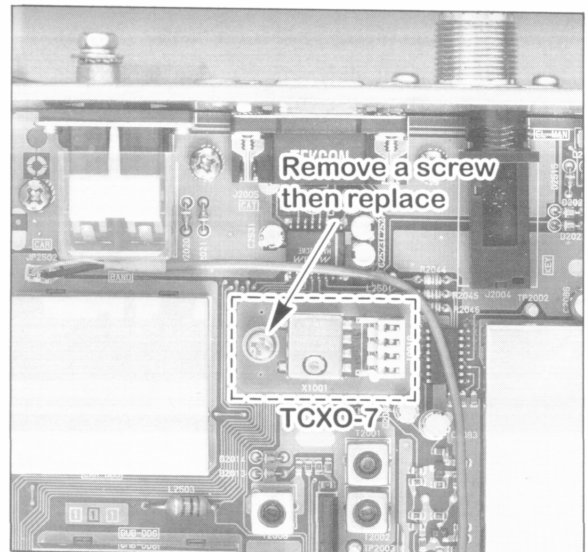

Figure 4



Figure 5

## **CAUTION !**

Changes or modifications to this device not expressly approved by Yaesu Musen could void the user's authorization to operate this device.

1. This device complies with part 15 of the FCC Rules. Operation is subject to the following two conditions; (1) this device may not cause harmful interference, and (2) this device must accept any interference including interference that may cause undesired operation.
2. The scanning receiver in this equipment is incapable of tuning, or readily being altered, by the User to operate within the frequency bands allocated to the Domestic public Cellular Telecommunications Service in Part 22.

This device complies with RSS-210 of Industry Canada. Operation is subject to the following two condition; (1) this device not cause interference, and (2) this device must accept any interference, including interference that may cause undesirable operation of the device.

# **YAESU**

*.... leading the way.<sup>SM</sup>*

**Copyright 1997  
Yaesu Musen Co., Ltd.  
All rights reserved.**

**No portion of this manual  
may be reproduced without  
the permission of  
Yaesu Musen Co., Ltd.**