

YAESU

The radio

AIR BAND TRANSCEIVER

FTA-310

Operating Manual

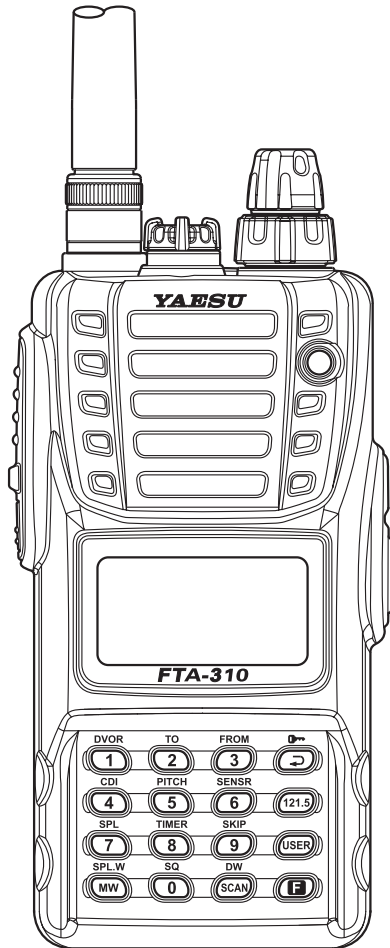

CONTENTS

Important Notice!	1	Advanced Operation	17
Introduction	2	Tuning Methods.....	17
Accessories & Options	3	Reception of Weather Channel Broadcasts.....	18
Control & Connectors	5	Monitor Switch	19
Top Panel	5	ANL (Automatic Noise Limiter) Feature	19
Front Panel.....	6	Temperature/battery Voltage Display	20
Side Panel	7	LOCK Function	21
Keypad.....	8	Beep On/Off.....	21
LCD Display.....	9	Receive Battery Saver Setup	22
Before You Begin	10	Changing the Channel Steps.....	23
Precautions.....	10	Pitch Control.....	24
Belt Clip Installation.....	10	VOX Operation.....	25
Battery Installation and Removal	11	PA Operation.....	26
Battery Charging.....	12	Timer Operation.....	28
Low Battery Indication.....	13	Memory Operation	30
Installing the FBA-25A Alkaline Battery Case	13	Memory System Operation.....	30
Basic Operation	14	Memory Storage	30
Preliminary Steps.....	14	Recalling the Memories.....	31
Operation Quick Start.....	14	Scanning Operation	32
Squelch Adjustment.....	15	Dual Watch Operation	34
Accessing the 121.5 MHz Emergency Frequency.....	16	Priority Dual Watch Operation	35
Transmission.....	16	VOR Navigation	36
		To Select the DVOR Mode.....	37
		Flying to a VOR Station	38
		Entering a Desired Course.....	40
		Position Cross-checking	41
		Split Operation.....	42
		Programming the USER Key Assignment	43
		Field Programming Mode	44
		CPU Resetting	45
		Menu (“Set”) Mode	46
		Specifications	54
		Troubleshooting	56
		Book Memory Channel List	57

NOTICE

There are no user-serviceable points inside this transceiver. All service jobs must be referred to your Authorized Service Center.

IMPORTANT NOTICE!

FCC RF Exposure Compliance Requirements for Occupational Use Only:

The **FTA-310** has been tested and complies with the Federal Communications Commission (FCC) RF exposure limits for Occupational Use/Controlled Exposure Environment. In addition, it complies with the following Standards and Guidelines:

- ❑ FCC 96-326, Guidelines for Evaluating the Environmental Effects of Radio-Frequency Radiation.
- ❑ FCC OET Bulletin 65 Edition 97-01 (1997) Supplement C, Evaluating Compliance with FCC Guidelines for Human Exposure to Radio Frequency Electromagnetic Fields.
- ❑ ANSI/IEEE C95.1-1992, IEEE Standard for Safety Levels with Respect to Human Exposure to Radio Frequency Electromagnetic Fields, 3 kHz to 300 GHz.
- ❑ ANSI/IEEE C95.3-1992, IEEE Recommended Practice for the Measurement of Potentially Hazardous Electromagnetic Fields - RF and Microwave.
- **This radio is NOT approved for use by the general population in an uncontrolled environment. This radio is restricted to occupational use, work related operations only where the radio operator must have the knowledge to control its RF exposure conditions.**
- **When transmitting, hold the radio in a vertical position with its microphone 1 to 2 inches (2.5 to 5 cm) away from your mouth and keep the antenna at least 1 inch (2.5 cm) away from your head and body.**
- **The radio must be used with a maximum operating duty cycle not exceeding 50%, in typical Push-to-Talk configurations. DO NOT transmit for more than 50% of total radio use time (50% duty cycle). Transmitting more than 50% of the time can cause FCC RF exposure compliance requirements to be exceeded.**
The radio is transmitting when the red LED on the upper right corner of the front panel of the radio is illuminated. You can cause the radio to transmit by pressing the P-T-T button.
- **Always use Yaesu authorized accessories.**

INTRODUCTION

The YAESU **FTA-310** is a compact, stylish, solid hand-held transceiver providing communication (transmit and receive) capability on the International Aircraft Communication Band (“COM” band: 118 ~ 136.975 MHz), and it additionally provides VOR and CDI navigation features on the “NAV” band (108 ~ 117.975 MHz).

The **FTA-310** boasts 0.8 Watt of clean audio output from its 1.4” (36-mm) diameter loudspeaker, and it also provides 8.33 kHz synthesizer steps for the receiving of the new narrow-band channel plan. The **FTA-310** includes both Temperature and Supply Voltage displays with our exclusive Omni-Glow™ display back-lighting for minimal degradation of your night vision, NOAA weather band monitoring, 8-character Alpha/Numeric Display, 150 Memory Channels, and up to 100 “Book Memory” Channels. The channel configurations are can be easily reprogrammed in minutes using the optional PC Programming Kit and your PC.

We recommend that you read this manual in its entirety, so as to understand the many features of the **FTA-310** completely. Keep this manual handy, so you may use it for reference.

NOTE: The **FTA-310**’s VOR and CDI Navigation features are supplemental aids to navigation only, and are not intended to be a substitute for accurate (primary) VOR/CDI or landing service equipment.

Congratulations!

You now have at your fingertips a valuable communications tool, a YAESU two-way radio! Rugged, reliable and easy to use, your YAESU radio will keep you in constant touch with your friends and colleagues for years to come, with negligible maintenance or down-time.

Please take a few minutes to read this manual carefully. The information presented here will allow you to derive maximum performance from your radio, in case questions arise later on.

We’re glad you joined the YAESU team. YAESU products cover the entire spectrum of radio communications applications, and our worldwide support network is here to serve you. Let us help you get your message across.

ACCESSORIES & OPTIONS

Supplied Accessories

Ni-MH Battery Pack (7.2V)	FNB-83
Overnight Charger	PA-48B/C ※
Charger Cradle	CD-28
12 V DC Charging Cradle	CD-59
Helical Antenna	YHA-73
Quick Draw Belt Clip	CLIP-14
Headset Cable	CT-96
Alkaline Battery Case	FBA-25A
Operating Manual	
Warranty Card	

- ※ “**B**” suffix is for use with 100-240 VAC, Type-A plug or “**C**” suffix is for use with 100-240 VAC, Type-C plug.

Available Options

MH-44B4B	Speaker Microphone
E-DC-5B	DC Cable w/Noise Filter
E-DC-6	DC Cable; plug and wire only
VAC-370	Desktop Rapid Charger
	PC Programming Kit

Availability of accessories may vary. Some accessories are supplied as standard per local requirements, while others may be unavailable in some regions. Consult your YAESU Dealer for details regarding these and any newly-available options.

Connection of any non-YAESU-approved accessory, should it cause damage, may void the Limited Warranty on this apparatus.

ACCESSORIES & OPTIONS

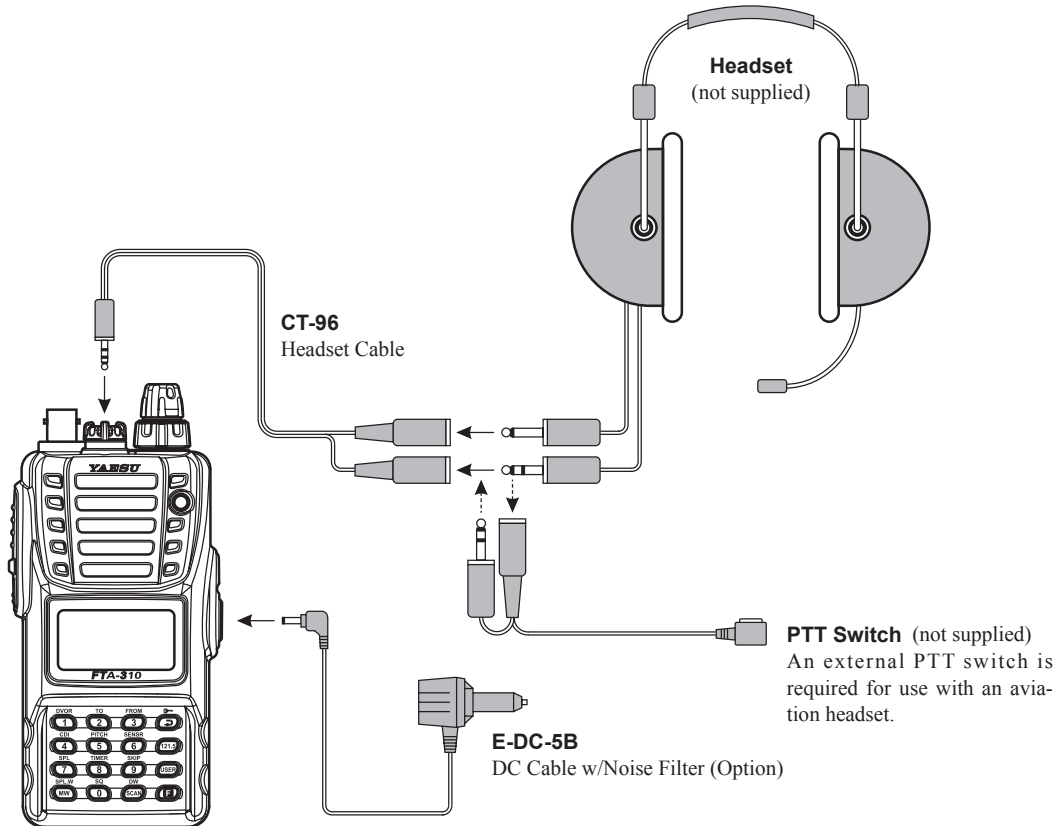

CONTROLS & CONNECTORS (TOP PANEL)

① Antenna Jack

This BNC connector accepts the supplied flexible antenna, or another antenna designed to provide 50 Ω impedance on the Aircraft Communication Band.

② MIC/EAR Jack

You may connect the supplied **CT-96** Headset Cable or the (optional) **MH-44B4B** Speaker/Microphone to this jack. To use this jack, you must first remove the plastic cap by rotating it counter-clockwise, then lifting it away from the transceiver body.



Do not allow the FTA-310 to become submerged in water while the plastic cover over the MIC/EAR jack is removed.

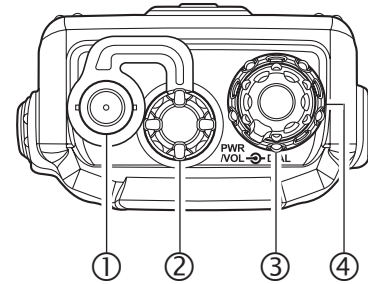

③ POWER/VOLUME (Inner) Knob

Turn this (inner) control clockwise to turn the radio on and to increase the volume. Counterclockwise rotation into the click-stop will turn the radio off.

Pressing this knob downward momentarily selects the tuning methods among the VFO (Variable Frequency Oscillator), MR (Memory Recall), BOOK (Pre-Programmed Memories), and WX (Weather Channel Memories) modes.

Note: The WX mode is available in the USA version only.

④ DIAL Selector (Outer) Knob

This (outer) 20-position detented rotary switch tunes the operating frequency or selects the memory channels.

CONTROLS & CONNECTORS (FRONT PANEL)

① **BUSY/TX** Indicator Lamp

This lamp glows green when a signal is being received, and red when transmitting.

② **Loudspeaker**

The internal speaker is located in this position.

③ **Microphone**

Speak across this opening in a normal voice level, while pressing the **PTT** switch, to transmit.

④ **LCD (Liquid Crystal Display)**

The display shows selected operating conditions, as indicated on the next page.

⑤ **Keypad**

The keypad is used for most radio command operations. Several keys have triple functions.

The primary functions are activated by simply pressing the key momentarily.

The secondary functions are activated by pressing the key followed by **[F]** key.

The third functions are activated by pressing and holding in the key for 2 seconds.

These functions are described in detail on page 8.

⑥ **Battery Pack Latch**

Open this latch for battery removal.

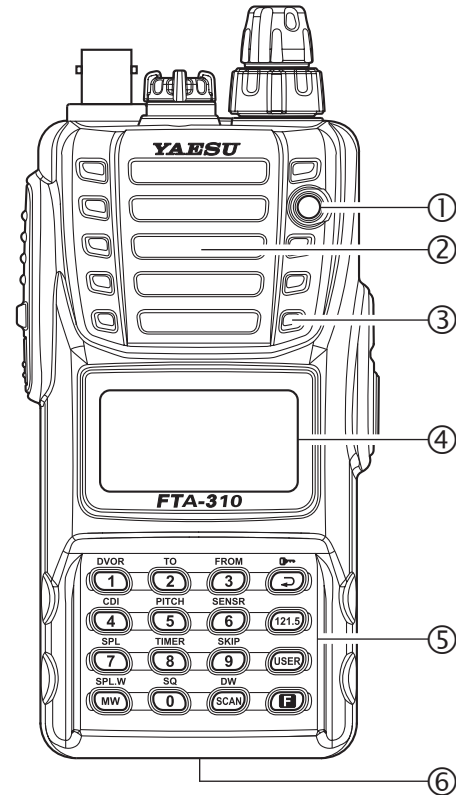

CONTROLS & CONNECTORS (SIDE PANEL)

① PTT (Push To Talk) Switch

Press this button to transmit when you are operating in the COM band. Release this button to return to the “Receive” mode. See page 16 for details.

② MONITOR Switch

This button may be pressed to “open” the squelch manually, allowing you to listen for very weak signals. Press and hold this button for 2 seconds to “open” the squelch continuously. Press this button again to resume normal (quiet) monitoring. See page 15 for details.

③ EXT DC Jack

When an external 12-Volt DC power source is available, you may connect the (optional) **E-DC-5B** External DC Cable here.







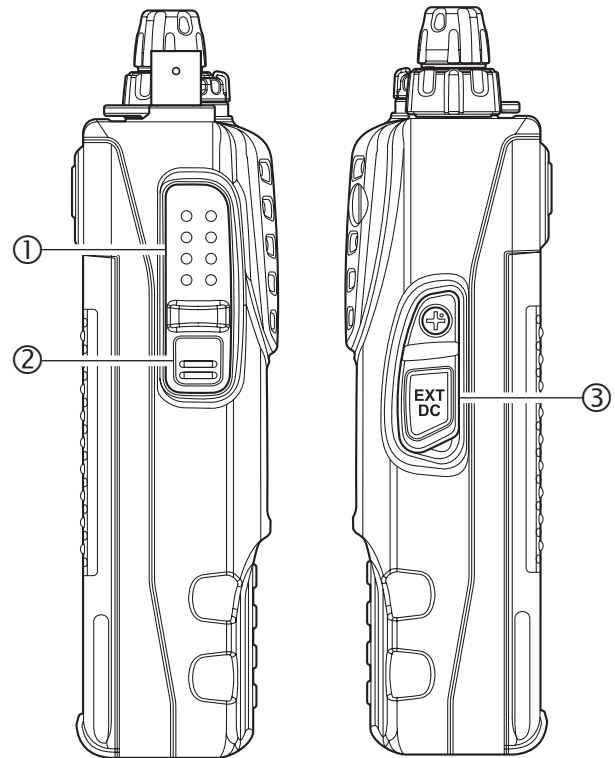

1) Do not allow the FTA-310 to become submerged in water while the rubber cover is removed.

2) Do not connect any wire to this jack if that wire is connected directly to a 28-Volt DC source. Connecting the FTA-310 directly to a source which exceeds 15.0 Volts DC will result in damage to the unit, and this type of damage is not covered by the Limited warranty on this product.



CONTROLS & CONNECTORS (KEYPAD)

	DVOR 	TO 	FROM 	
Primary Function (Press Key)	Frequency Entry Digit 1	Frequency Entry Digit 2	Frequency Entry Digit 3	Select Memory Display Type.
Secondary Function (Press [F] + key)	Activates DVOR mode.	Activates "TO" VOR mode.	Activates "FROM" VOR mode.	Activates the Key Lockout feature.
Third Function (Press and Hold key)	None	None	None	Selects DVOR Display Type
	CDI 	PITCH 	SENSR 	
Primary Function (Press Key)	Frequency Entry Digit 4	Frequency Entry Digit 5	Frequency Entry Digit 6	Selects Emergency Channel (121.5 MHz).
Secondary Function (Press [F] + key)	Activates Deviation Indicator mode.	Activates Pitch Control feature.	Displays the Battery Voltage and Current Temperature inside the transceiver's case.	None
Third Function (Press and Hold key)	None	None	None	None
	SPL 	TIMER 	SKIP 	
Primary Function (Press Key)	Frequency Entry Digit 7	Frequency Entry Digit 8	Frequency Entry Digit 9	Activates the Automatic Noise Limiter during AM reception.
Secondary Function (Press [F] + key)	Activates Split (Duplex) mode.	Activates the Stop Watch Timer.	Allows Skipping of Channel during Scan.	None
Third Function (Press and Hold key)	None	None	None	Activates the Public Address feature.
	SPL-W 	SQ 	DW 	
Primary Function (Press Key)	None	Frequency Entry Digit 0	Switches the VFO mode "A" and "B."	Activates "Secondary" key mode.
Secondary Function (Press [F] + key)	Split-Memory "Write" Command.	Adjusts the Squelch threshold level.	Activates the Dual Watch feature.	Cancel the "Secondary" key mode of the [F] key.
Third Function (Press and Hold key)	Memory "Write" Command.	None	Activates Scanning.	None

CONTROLS & CONNECTORS (LCD DISPLAY)

This field displays the course heading in degrees. See page 37.

This is the Course Deviation Indicator, used during VOR Navigation. See page 38.

This icon is used during VOR navigation, to indicate that the displayed information is based on a course **from** the VOR station. See page 37.

This indicator confirms that this channel will be skipped during scan. See page 33.

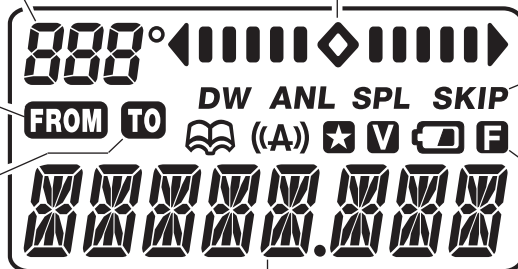

This icon is used during VOR navigation, to indicate that the displayed information is based on a course **to** the VOR station. See page 37.

This indicator confirms that **Secondary** Key Function is active. See page 8.

These digits provide frequency or alpha-numeric information about the channel you are using.

This icon is the “Low Battery” indicator, which blinks when the battery voltage becomes too low for proper operation.

DW

This indicator confirms that “Dual Watch” is active. See page 34.

ANL

This indicator confirms that “Automatic Noise Limiter” is active. See page 19.

SPL

This indicator confirms that the “Split” (Duplex) mode is activated during VOR operation. See page 42.



This icon indicates that the “Book” Memory Bank is in use. See page 17.

(A)

This icon indicates that the “Weather Alert” feature is active. See page 52.



This icon indicates that the channel step is selected to “8.33 kHz” in the NAV and COM band. See page 23.



This indicator confirms that “VOX” system is active. See page 25.

BEFORE YOU BEGIN

Precautions

- The **FTA-310** is capable of two-way communication on channels used for critical aviation safety communications. Therefore, it is important that this radio be kept away from children or other unauthorized users at all times.
- When making DC connections via the the optional **E-DC-5B/E-DC-6** DC cable, be absolutely certain to observe the proper voltage level and polarity guidelines. Do not connect this radio directly to any 24 ~ 28 Volt DC source, nor to AC power of any kind. Connecting the **FTA-310** directly to a source which exceeds 15.0 Volts DC will result in damage to the unit. The Limited Warranty for this product does not cover damage caused by the application of improper voltage.
- Do not dispose of the Ni-MH Battery Pack in a fire. Do not carry a Ni-MH Battery Pack in your pocket, where keys or coins could short the terminals. This could create a serious fire/burn danger, and possibly cause damage to the Ni-MH pack.
- Although the **FTA-310** is designed to be Submersible (3 ft., 30 min.), its enclosure is not designed to guarantee protection from ingress of water under extreme pressure. Do not allow the radio to become submerged in deep water, and do not subject it to water spray under pressure.

Belt Clip Installation

- Connect the hanger to the rear of the **FTA-310**, with the notch pointing directly up, using the supplied screw (Fig 1). Use only the screw included with the clip to mount the clip to the back of the **FTA-310**.
- Clip the Quick-Draw Belt Clip onto your belt (Fig 2).
- To install the **FTA-310** into the Quick-Draw Belt Clip, align the hanger with the Quick-Draw Belt Clip, and slide the **FTA-310** into its slot until a click is heard (Fig 3).
- To remove the **FTA-310** from the Quick-Draw Belt Clip, rotate the **FTA-310** 180 degrees, then slide the **FTA-310** out from the Quick-Draw Belt Clip (Fig 4).

BEFORE YOU BEGIN

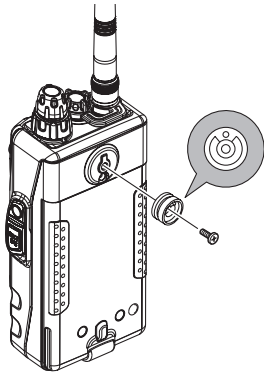

Fig 1

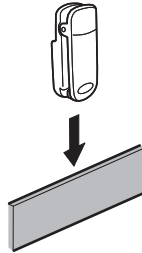

Fig 2

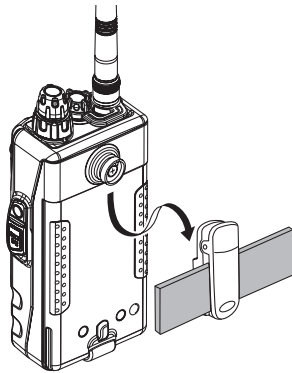

Fig 3

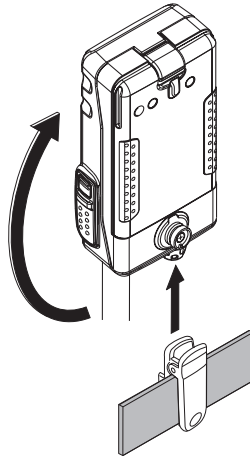
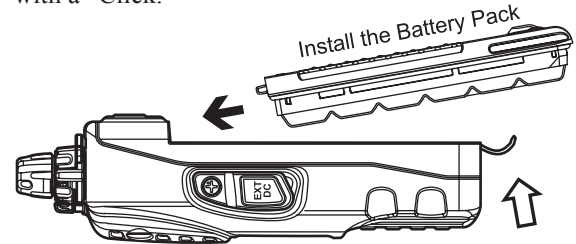

Fig 4

Battery Installation and Removal

- ❑ To install the battery, insert the battery pack into the battery compartment on the back of the radio, then close the Battery Pack Latch until it locks in place with a “Click.”



Close the Battery Pack Latch

- ❑ To remove the battery, turn the radio off and remove any protective cases. Open the Battery Pack Latch on the bottom of the radio, then lift the battery upward and out from the radio.

! *Do not attempt to open any of the rechargeable Ni-MH packs, as personal injury or damage to the Ni-MH pack could occur if a cell or cells become accidentally short-circuited.*

BEFORE YOU BEGIN

Battery Charging

It is necessary to charge the Ni-MH battery fully before its first use. Follow these procedures:

- ❑ Install the supplied **FNB-83** Ni-MH battery pack onto the transceiver. Ensure that the transceiver is switched off.

Use for PA-48/CD-28

1. Insert the cable plug into the jack located on the right side of the **CD-28** Charging Cradle then plug the **PA-48** Battery Charger into the AC line outlet.
2. Insert the transceiver and battery pack into the **CD-28**; the antenna jack should be at the left side when viewing the charger from the front.
3. If the transceiver and battery pack are inserted correctly, the RED indicator on the **CD-28** will glow. A fully-discharged pack will be charged completely in 12 hours.

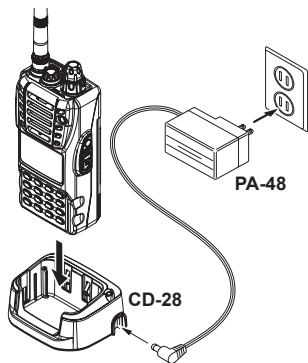

Use for CD-59

1. Insert the cigarette lighter plug into the cigarette lighter socket (DC 11 V ~ 16 V).
2. Insert the transceiver and battery pack into the **CD-59**; the antenna jack should be at the left side when viewing the charger from the front.
3. If the transceiver and battery pack are inserted correctly, the RED indicator on the **CD-59** will glow. A fully-discharged pack will be charged completely in 15 hours.

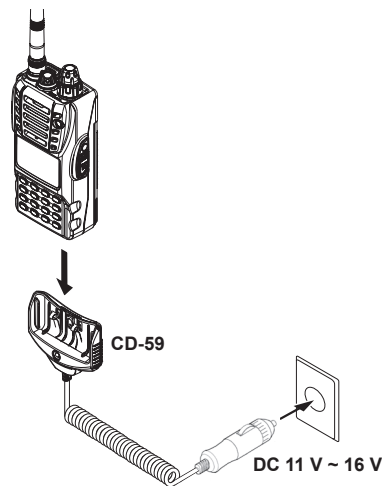

BEFORE YOU BEGIN

Important Notes:

- The **PA-48** is not designed to power the transceiver for operation (reception or transmission).
- Do not leave the charger connected to the transceiver for continuous periods in excess of 24 hours. Long term overcharging can degrade the Ni-MH battery pack and significantly shorten its useful life.
- If using a charger other than the **PA-48/CD-28**, **CD-59**, or if using a battery pack other than the **FNB-83**, follow the appropriate instructions provided with the charger/battery. Contact your Dealer if you have any doubts about the appropriateness of the particular charger or battery pack you intend to use.

Low Battery Indication

- As your battery discharges during use, the voltage will gradually become lower. When the battery voltage reaches 6.0 Volts, the “” icon will blink on the LCD display, indicating that the battery pack must be recharged before further use.
- Avoid recharging Ni-MH batteries before the “Low Battery” indicator is observed, as this can degrade the charge capacity of your Ni-MH battery pack. YAESU recommends that you carry an extra, fully-charged pack with you so you will not lose communications capability due to a depleted Ni-MH battery.



Installing the FBA-25A Alkaline Battery Case

The supplied **FBA-25A** Battery Case allows operation of the **FTA-310** using six “AA” size Alkaline batteries.

When installing batteries, insert the (–) end first, then press in the (+) end so the battery snaps into place. Always replace all six batteries at the same time, paying attention to the polarity indicated inside the case.



*The **FBA-25A** must not be used with rechargeable cells. The **FBA-25A** does not contain the thermal and over-current protection circuits (provided in the “**FNB**” series of Ni-MH Battery Packs) required when utilizing Ni-Cd and Ni-MH cells.*

BASIC OPERATION

Preliminary Steps

- Install a charged battery pack onto the transceiver, as described previously.
- To attach the supplied antenna to the **FTA-310**, grasp the base of the antenna firmly, and exert a moderate “pinching” pressure on the base as you press the antenna onto the radio’s antenna connector. While exerting this pressure, rotate the antenna clockwise 1/4 turn to lock the antenna in place.

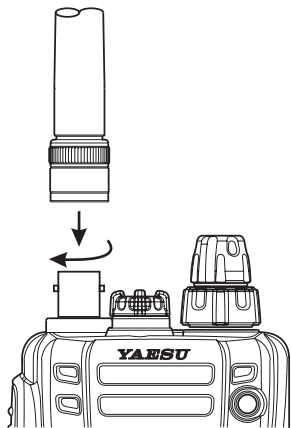

Operation Quick Start

- To turn the radio on, rotate the (inner) **VOLUME** knob out of the click-stop.

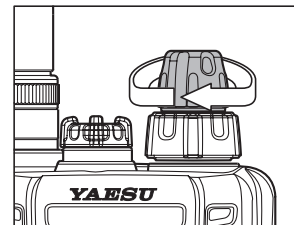

- A channel frequency should appear on the display. If not, press downward (momentarily) on the **VOLUME** knob (repeatedly, if necessary) so that “- VFO -” appears on the display, followed by a channel frequency.

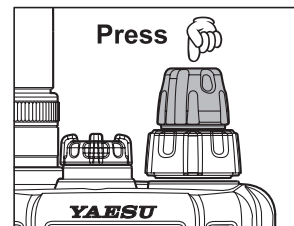

- Directly entering frequencies from the keypad is the easiest method if you know the frequency on which you wish to operate. Just enter the five digits of the frequency to move to that frequency.

For example, to set 134.35 MHz, press [1] → [3] → [4] → [3] → [5].

To set 118.275 MHz, you do not need to press the final “5” in the frequency:

[1] → [1] → [8] → [2] → [7].

BASIC OPERATION

- ❑ You may also turn the top panel's (outer) **DIAL** selector knob to choose the desired operating frequency. The channel frequency will appear on the LCD.

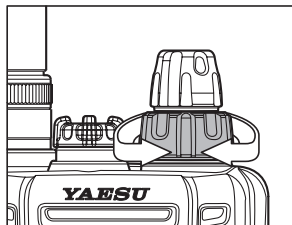

- ❑ Rotate the **VOLUME** knob to set the volume level. If no signal is present, press and hold the **MONITOR** switch for 2 seconds; background noise will now be heard, and you may use this noise to set the **VOLUME** knob for the desired audio level. Press the **MONITOR** switch momentarily to silence the noise and resume normal (quiet) monitoring.

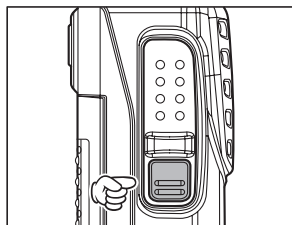
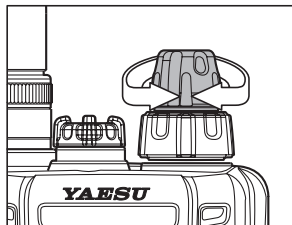

- ❑ *To turn the radio off,* turn the **VOLUME** knob fully counter-clockwise into the click stop position.

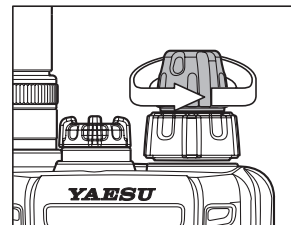

Squelch Adjustment

- ❑ Press the [**F**] key momentarily, then press the [**0 (SQ)**] key. This instantly recalls Menu Item 01 "SQL" which adjusts the threshold level of the squelch circuit.
- ❑ Rotate the **DIAL** selector knob to set the squelch threshold (0 to 8) so that the receiver is just silenced. A higher number indicates that a higher signal level is required in order to open the squelch.
- ❑ Press downward on the **VOLUME** knob to save your new setting.
- ❑ Press the **PTT** switch to exit the Menu ("SET") mode.

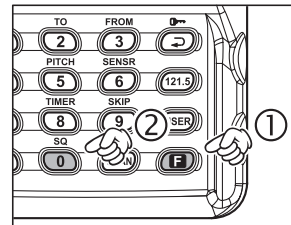

BASIC OPERATION

Accessing the 121.5 MHz Emergency Frequency

The **FTA-310** can quickly access the 121.500 MHz Emergency Frequency. This function can be activated even when the keypad lock function (described on page 21) is in use.

- ❑ To access the Emergency Frequency, press the [121.5] key momentarily.
- ❑ To exit the Emergency Frequency, press downward on the **VOLUME** knob.

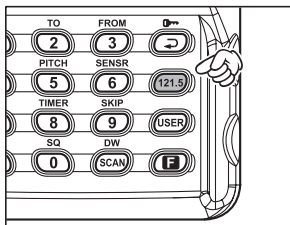

Transmission

- ❑ To transmit, press and hold the **PTT** switch. Speak into the microphone area of the front panel grille in a normal voice level.
- ❑ To return to the receive mode, release the **PTT** switch.

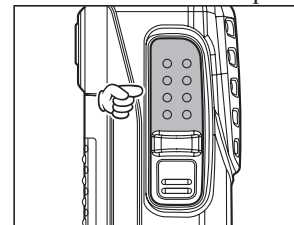

Operating Advice: Use of Internal Microphone

Your **FTA-310** is extensively sealed against water ingress, so as to ensure reliable operation even if it has become submerged. This unique construction includes waterproofing seals around the microphone and speaker enclosure, requiring that care be exercised when speaking into the internal microphone.

Please refer to the illustration, and observe the location of the internal microphone. It is important that you focus your speech in the direction of the microphone's location, so as to ensure sufficient voice input to the radio.

If you find it difficult to utilize the **FTA-310** conveniently and safe while speaking directly into the microphone, we recommend the use of the **MH-44B4B** Speaker/Microphone (option), or an after-market aviation headset/boom microphone.

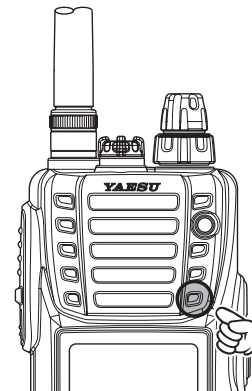

ADVANCED OPERATION

Tuning Methods

Throughout this manual, you will see references to several different frequency setting methods. Each will be particularly useful in a particular operating situation, and they are described below:

○ VFO (Variable Frequency Oscillator)

The VFO is a “tuning dial” system which allows you to tune through the NAV or COM bands using the **DIAL**

selector, the Keypad, or the scanner. The **FTA-310** has two VFOs which are called VFO-A and VFO-B. Press the [**SCAN(DW)**] key momentarily to switch between VFO-A and VFO-B. You may set VFO-A to the NAV band, and VFO-B to the COM band, if you like.



○ MR (Memory Recall)

The MR (Memory Recall) mode of the **FTA-310** provides the user with the ability to store and recall as many as 150 channels in the radio's main memory bank. These memory channels may also be labeled by you with an alpha/numeric name of up to 8 characters in length, to aid in quick identification of the channel. See page 30 for details on creating alpha/numeric labels.



○ BOOK (Pre-Programmed) Memories

The Book memories are pre-programmed, either at the factory or by your Dealer (depending on your country's requirements), typically including the major COM and NAV band station frequencies used in your area. The Book memories can be changed by the user. See page 44 for details.



○ WX (Weather Channel) Memories (USA version only)

Ten Weather Channels are pre-programmed at the factory. The **FTA-310** will automatically scan this special bank when it is selected by the user.

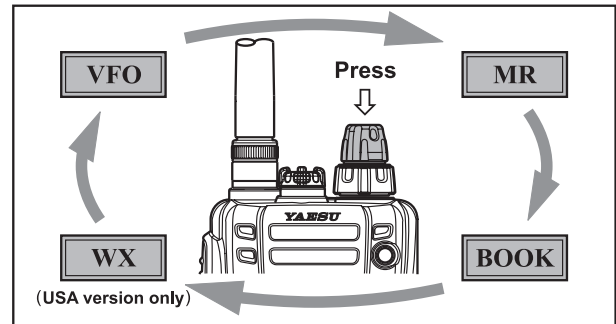

ADVANCED OPERATION

Reception of Weather Channel Broadcasts (USA version only)

The **FTA-310** can receive VHF Weather Channel broadcasts, which may assist your flight planning. The **FTA-310** includes a ten-channel auto-search feature, which simplifies access to Weather Channels when you are in an unfamiliar location.

- ❑ To receive Weather Channels, press downward on the **VOLUME** knob (repeatedly, if necessary) to select the Weather Channel mode. In the Weather Channel mode, “- **WX** -” will appear on the display.
- ❑ The **FTA-310** will now scan quickly through the ten standard Weather Channels, and will stop on the first active station found.
- ❑ If there are two or more weather channels audible in your area, you may select the alternate channel(s) by pressing the **PTT** switch. Pressing the **PTT** switch re-initiates the scanning process.
- ❑ If there are no Weather Channels in your area, the scanner will not stop. Press the **MONITOR** switch to stop the scanner.

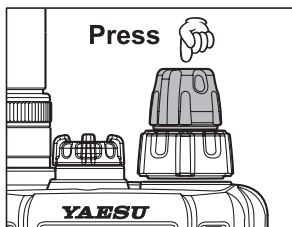

- ❑ You can also select Weather Channels manually by rotating the **DIAL** selector knob.
- ❑ To confirm the current Weather Channel frequency, press the [**↶**(**🔑**)] key momentarily. The display changes to frequency indication. Press the [**↶**(**🔑**)] key again to return to normal display.
- ❑ To exit the Weather Channel mode, press downward on the **VOLUME** knob momentarily to return to the VFO mode.

Note 1:

In the event of extreme weather disturbances, such as storms and hurricanes, the NOAA (National Oceanic and Atmospheric Administration) sends a weather alert accompanied by a 1050 Hz tone and subsequent weather report on one of the NOAA weather channels. You may setup the Alert function when receiving the Weather Alert signal via Menu Item 20 “WXAF,” if desired. See page 52 for details.

Note 2:

The Weather Channel mode memorizes the last Weather Channel you have used, and will retain this information until the radio is turned off.

ADVANCED OPERATION

Monitor Switch

When listening to a very weak signal from an aircraft or ground station, you may observe the signal disappearing periodically as the incoming signal strength becomes too weak to override the squelch threshold setting.

To disable the squelch temporarily, press and hold the **MONITOR** switch for 2 seconds on the left side of the radio, just below the **PTT** switch. The squelch will remain open and you should have a better chance of hearing weak signals.

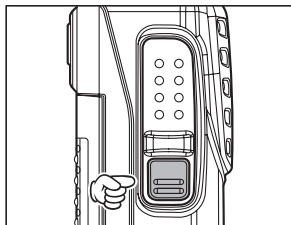

To return to normal operation, press the **MONITOR** switch momentarily.

ANL (Automatic Noise Limiter) Feature

For reduction of impulse noise, such as that produced by an engine's ignition system, the ANL feature may prove helpful. The ANL feature is only activated in the AM mode.

- To activate the ANL feature, press the [USER] key momentarily. The “**ANL**” icon will appear on the display, and you should observe a reduction in the ignition noise.
- To turn the ANL feature off, repeat the above step; the “**ANL**” icon will disappear from the display.

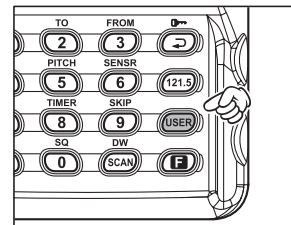

ADVANCED OPERATION

Temperature/Battery Voltage Display

The **FTA-310** can measure the current temperature inside the transceiver's case and current battery voltage.

- ❑ To display these items, press the [F] key momentarily, then press the [6 (SENSR)] key.
- ❑ The display will now indicate the current temperature inside the transceiver's case or current battery voltage. press downward on the **VOLUME** knob to switch the display between “current temperature” and “current battery voltage.”

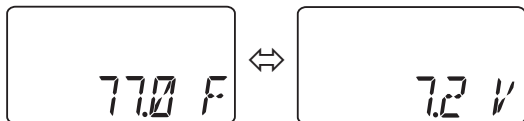
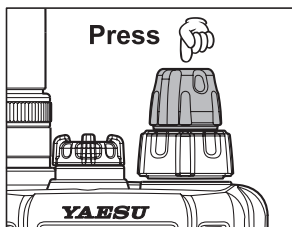
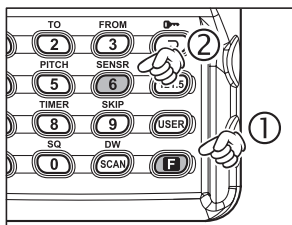

- ❑ When the **FTA-310** display “current temperature,” pressing the [↩ (KEY)] key to switch the temperature unit between “Celsius: °C” and “Fahrenheit: °F.”

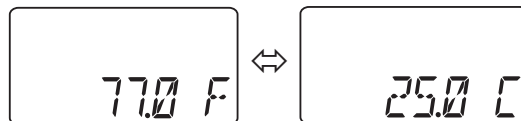
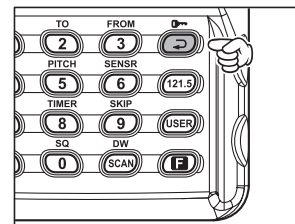

- ❑ To return to the normal operation, press [F] → [6 (SENSR)] again.

If the temperature display is incorrect, it can be recalibrated via Menu Item 14 “TEMP.” See page 51 for details.

ADVANCED OPERATION

LOCK Function

The lock function prevents accidental changes to the frequency setting and the keypad controls.

- ❑ To activate the lock feature, press the [F] key momentarily, then press the [↩️(🔑)] key.
- ❑ In the LOCK mode, the display will show “- LOCK -” when you rotate the **DIAL** selector knob, press downward on the **VOLUME** knob, or touch a key on the keypad.
- ❑ To turn the lock feature off, press [F] → [↩️(🔑)] again.
- ❑ You can still access the 121.500 MHz Emergency Frequency when the LOCK function is on. Simply press the [121.5] key momentarily (this key never locks). Pressing this key also unlocks the radio.

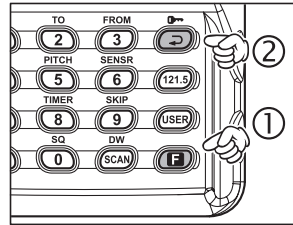

You may choose the lockout configuration according to your operating preferences. See page 51 for details.

Beep On/Off

The **FTA-310**'s key/button beeper provides convenient audible feedback whenever a button is pressed. Each key and button has a different beep pitch, and each function has a unique beep combination.

When you are scanning, the beeper will be heard each time the scanner halts on a busy channel. This may be distracting in some environments; if you want to turn the beeper off (or back on again):

- ❑ Press the [F] key, then press downward on the **VOLUME** knob to activate the Menu (“SET”) mode.
- ❑ Rotate the **DIAL** selector knob to select Menu Item 05 “BEEP.”
- ❑ Press downward on the **VOLUME** knob to enable adjustment of this Menu item.
- ❑ Rotate the **DIAL** selector knob to select the desired “beeper.” The selections available are on, DTM, and oFF.
on: Sounds a beep corresponding to a musical note.
DTM: Sounds a beep corresponding to a DTMF tone.
oFF: Disables the key beeper.
- ❑ When you have made your selection, press downward on the **VOLUME** knob to save the new setting, and then press the **PTT** key to exit to normal operation.

ADVANCED OPERATION

Receive Battery Saver Setup

An important feature of the **FTA-310** is its Receive Battery Saver, which “puts the radio to sleep” for a time interval, periodically “waking it up” to check for activity. If somebody is talking on the channel, the **FTA-310** will remain in the “active” mode, then resume its “sleep” cycles. This feature significantly reduces quiescent battery drain, and you may change the amount of “sleep” time between activity checks using the Menu System:

- Press the **[F]** key, then press downward on the **VOLUME** knob to activate the Menu (“SET”) mode.
- Rotate the **DIAL** selector knob to select Menu Item 06 “RSAV.”
- Press downward on the **VOLUME** knob to enable adjustment of this Menu item.
- Rotate the **DIAL** selector knob to select the desired “duty cycle” (receive:sleep). The selections available are 1:1, 1:2, 1:3, 1:4, 1:5, and ABS[×] or off. The default value is 1:1.
- When you have made your selection, press downward on the **VOLUME** knob to save the new setting, and then press the **PTT** key to exit to normal operation.

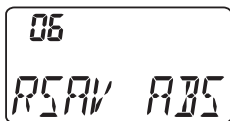

- ※ ABS: Automatic Battery Saver, based on activity on the receiver.

The setting of 1:5 will promote the greatest conservation of battery capacity, but the receiver’s response time to incoming calls will be slowed somewhat.

Note: This feature does not operate during Scan or Dual Watch.

ADVANCED OPERATION

Changing the Channel Steps

The **FTA-310**'s synthesizer provides the option of utilizing channel steps of 8.33/25 kHz per step.

The **FTA-310** is set up with default channel steps of "25 kHz" (NAV and COM bands). If you need to change the channel step increments, the procedure to do so is very easy.

- First set the **FTA-310** to the operating band (VFO A or VFO B and NAV or COM) on which you wish to change the channel steps.
- Press the [F] key, then press downward on the **VOLUME** knob to activate the Menu ("SET") mode.
- Rotate the **DIAL** selector knob to select Menu Item 30 "STEP."
- Press downward on the **VOLUME** knob to enable adjustment of this Menu item.
- Rotate the **DIAL** selector knob to select the new channel step size.
- When you have made your selection, press downward on the **VOLUME** knob to save the new setting, and then press the **PTT** key to exit to normal operation.



Important Note

- 1) When you set the channel step to 8.33 kHz, the channel display differs from actual operating frequency; see the chart below. However, the operator (pilot, tower, control, etc) will call out the frequency according to what the display indicates.

When you set the channel steps to 8.33 kHz, the "★" icon will appear in the display.



Operating Frequency	Display	
	8.33 kHz Step	25 kHz Step
1xx.0000 MHz	1xx.005 MHz	1xx.000 MHz
1xx.0083 MHz	1xx.010 MHz	
1xx.0166 MHz	1xx.015 MHz	
1xx.0250 MHz	1xx.030 MHz	1xx.025 MHz
1xx.0333 MHz	1xx.035 MHz	
1xx.0416 MHz	1xx.040 MHz	
1xx.0500 MHz	1xx.055 MHz	1xx.050 MHz
1xx.0583 MHz	1xx.060 MHz	
1xx.0666 MHz	1xx.065 MHz	
1xx.0750 MHz	1xx.080 MHz	1xx.075 MHz
1xx.0833 MHz	1xx.085 MHz	
1xx.0916 MHz	1xx.090 MHz	

- 2) The 8.33 kHz step allows the radio to receive only, and the transmit function is disabled.
- 3) The adjacent channel selectivity will be slightly degraded while receiving using 8.33 kHz channel steps.

ADVANCED OPERATION

Pitch Control

The **FTA-310** includes a feature that lets you choose four special receiver audio responses to allow the most comfortable and/or effective reception in noisy environments. The effect is similar to that provided by an “Equalizer” in a stereo.

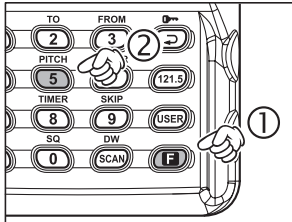
- ❑ Press the [**F**] key momentarily, then press the [**5 (PITCH)**] key. This instantly recalls Menu Item 31 “PIT” which selects the receiver audio responses.
- 

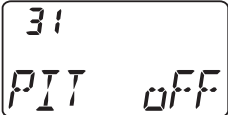
- ❑ Rotate the **DIAL** selector knob to select desired receiver audio response. Available selections are:
 - oFF: The received audio signal does not pass through the equalizer circuit.
 - MD1: The received audio is passed without roll-off on the high or low ends.
 - MD2: The received audio is enhanced in the low and mid-range frequencies.
 - MD3: The received audio is enhanced in the mid and high-range frequencies.
- 

USR: The received audio is shaped per a user-configured audio response programmed via Menu Items 26 “UP_L,” 27 “UP_M,” and 28 “UP_H.” The default setting enhances the audio in the lower frequency range, and reduces the level of the higher-frequency components.

- ❑ When you have made your selection, press downward on the **VOLUME** knob to save the new setting, and then press the **PTT** key exit to normal operation.

SELECTION	RESPONSE	LOW-RANGE	MID-RANGE	HIGH-RANGE
oFF	Normal	0	0	0
MD1	Full Boost	+	+	+
MD2	Low Boost	+	+	-
MD3	High Boost	-	+	+
USR	Default	+	0	-

ADVANCED OPERATION

VOX Operation

If you want to have both hands free, use the (user-supplied) Headset and activate the VOX (voice-actuated transmit/receive switching) system.

Note: The VOX system does not function when using just the internal microphone; an external headset must be used.

To activate the VOX system using the Menu System:

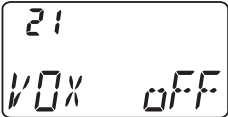
- Press the [F] key, then press downward on the **VOLUME** knob to activate the Menu (“SET”) mode.
- Rotate the **DIAL** selector knob to select Menu Item 21 “VOX.” 
- Press downward on the **VOLUME** knob to enable adjustment of this Menu item.
- Rotate the **DIAL** selector knob to select “on” (to enable the VOX system).
- When you have made your selection, press downward on the **VOLUME** knob to save the new setting, and then press the **PTT** switch to exit to normal operation.
- Without pressing the **PTT** switch, speak into the microphone in a normal voice level. When you start speaking, the transmitter should be activated automatically. When you finish speaking, the transceiver should return to the receive mode (after a short delay).

- To cancel VOX and return to **PTT** operation, just repeat the above procedures, selecting “oFF” in step 4 above.

When the VOX system is activated, the “**V**” icon will appear on the display.



The **FTA-310** provides for adjustment of the VOX Gain via the Menu, to prevent accidental transmitter activation in a noisy environment. To set the VOX Gain:

- Press the [F] key, then press downward on the **VOLUME** knob to activate the Menu (“SET”) mode.
- Rotate the **DIAL** selector knob to select Menu Item 23 “VSNS.” 
- Press downward on the **VOLUME** knob to enable adjustment of this Menu item.
- While speaking into the microphone, rotate the **DIAL** selector knob to the point where the transmitter is quickly activated by your voice, without causing background noise to activate the transmitter.
- When you have selected the optimum setting, press downward on the **VOLUME** knob to save the new setting, and then press the **PTT** switch to exit to normal operation.

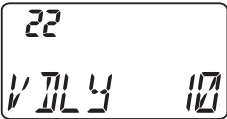

ADVANCED OPERATION

The **FTA-310** also provides for adjustment of the “Hang-Time” of the VOX system (the transmit-receive delay after the cessation of speech) via the Menu. The default delay is 1.0 second. To set a different delay time:

- ❑ Press the [F] key, then press downward on the **VOLUME** knob to activate the Menu (“SET”) mode.
- ❑ Rotate the **DIAL** selector knob to select Menu Item 22 “VDLY.” 
- ❑ Press downward on the **VOLUME** knob to enable adjustment of this Menu item.
- ❑ Rotate the **DIAL** selector knob to select the delay time among “05,” “10,” “15,” and “20” (representing 0.5, 1.0, 1.5, and 2.0 sec).
- ❑ When you have made your selection, press downward on the **VOLUME** knob to save the new setting, and then press the **PTT** switch to exit to normal operation.

PA Operation

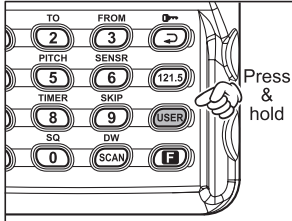
The PA mode allows the **FTA-310** to be used as a Public Address System when an optional **MH-44B4B** Microphone or other Headset/Microphone is connected.

- ❑ Press and hold in the [USER] key for 2 seconds to activate the PA mode. 
- ❑ Speak through the microphone while pressing and hold in the **PTT** switch on the microphone or headset/microphone. The “*Course Deviation Needle*” will deflect in accordance with the voice level. Rotate the **VOLUME** knob to control the audio output level. 
- ❑ To exit the PA mode, press and hold in the [USER] key again.

The **FTA-310** provides for customization of the voice monitor feature via the Menu while using a Headset. To select the monitor configuration:

- ❑ Press the [F] key, then press downward on the **VOLUME** knob to activate the Menu (“SET”) mode.

ADVANCED OPERATION

- ❑ Rotate the **DIAL** selector knob to select Menu Item 25 “PAMO.”
- ❑ Press downward on the **VOLUME** knob to enable adjustment of this Menu item.
- ❑ Rotate the **DIAL** selector knob to select the desired monitor mode.
 - oFF: Disables the monitor function at all times.
 - PA: Feeds back your voice to the headset while you’re pressing the **PTT** switch.
 - ALL: Feeds back your voice to the headset while you’re pressing the **PTT** switch. When the **PTT** switch is off, you may monitor the sound around the transceiver (the monitor will pick up the background sound using the **FTA-310**’s internal microphone).
- ❑ When you have made your selection, press downward on the **VOLUME** knob to save the new setting, and then press the **PTT** switch to exit to normal operation.



Note: Do not activate the voice monitor feature while using with the optional **MH-44B4B** Microphone. The voice monitor feature will tend to produce “howling” due to feedback.

ADVANCED OPERATION

Timer Operation

The **FTA-310** is provided a “Stop Watch” timer and a “Count Down” timer. These can be used for a variety of time-keeping purposes.

- Press the [F] key momentarily, then press the [8 (TIMER)] key to activate the Timer Mode.

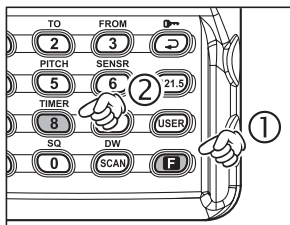

- Press the [↔] key toggle the Timer between the “Stop Watch” and “Count Down” timer modes.

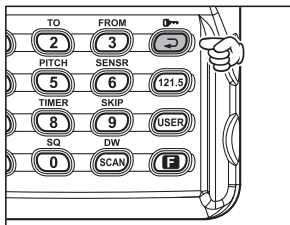

- If you select the “Count Down” timer, rotate the **DIAL** knob to set the values for the timer (1 minutes - 60 minutes).
- The Timer is designed to start/stop/reset repeatedly whenever you press downward on the **VOLUME** knob.
- In the “Count Down” timer mode, an alert will sound and the timer will stop when the “Count Down” timer reaches “00 00 00.”
- To disable the Timer Mode, press [F] → [8 (TIMER)] again.

ADVANCED OPERATION

Notes

MEMORY OPERATION

The **FTA-310** provides 150 user-programmable “Main” memories, labeled “CH-001” through “CH-150,” and up to 100 pre-programmed memories, designated “Book” Memories. The “” icon appears when the “Book” Memory Mode is activated.

The Main memories and “Book” Memories can be assigned alpha-numeric names of up to eight characters.

Memory System Operation

The **FTA-310**'s Main Memory system allows the user to store, label, and recall channel frequencies which you may want to use frequently. You may store VFO frequencies, Book Memory frequencies, and/or Weather Channel frequencies (USA version only) into the Main Memory system.

Memory Storage

- ❑ Select the desired frequency in the VFO mode, or recall the Book Memory channel or Weather channel to be stored in the Main Memory.

- ❑ Press and hold in the **[MW (SPL-W)]** key for 2 seconds. The display will indicate “CH-XXX” and a channel number will blink on the LCD.

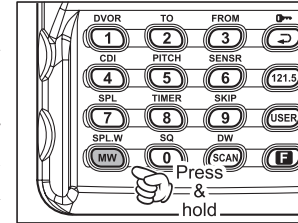

- ❑ Within five seconds of pressing the **[MW (SPL-W)]** key, rotate the **DIAL** selector knob to select the desired memory channel number for storage.

In order to prevent writing over memory channels, a small “” icon will appear at the right side of the channel number to indicate a vacant memory channel.



- ❑ Now press and hold in the **[MW (SPL-W)]** key for 2 seconds; you will now see blinking “A” on the LCD. To attach an alpha/numeric name (label) to the memory, proceed to the next step; otherwise press and hold in the **[MW (SPL-W)]** for 2 seconds to save the entry and exit.

MEMORY OPERATION

- ❑ To label a memory with an alpha/numeric name, the next step is to use the **DIAL** selector knob to select any of the 48 available characters (including letters, numbers, and special symbols). When the desired first character appears, press downward on the **VOLUME** knob momentarily to move on to the next character.
- ❑ Select succeeding characters in the same manner, press downward on the **VOLUME** knob momentarily after each selection.
- ❑ After entering the entire name (eight characters maximum), press the [**MW (SPL-W)**] key for 2 seconds to save all data for the channel and exit.

Note: If you have transferred a Weather Channel directly to memory, the “WX-001 ~ WX-010” labels utilize the alphanumeric memory, and other labels may not be stored. But if you go to the VFO mode, and dial up or key in the weather station’s frequency manually, you may then store the frequency and a custom alphanumeric label yourself.

Recalling the Memories

- ❑ press downward on the **VOLUME** knob, repeatedly if necessary, until “- **MR** -” (Memory Recall) appears on the display. In the MR mode, you will see “CH-” and the previously selected channel number appearing on the LCD.
- ❑ Rotate the **DIAL** selector knob to select the desired memory channel.
- ❑ You may change the title structure of the Memory display type among:
 1. Channel Indication (sequential Channel Number, e.g. CH-001, CH-002, etc.);
 2. Frequency Indication (e.g. 122.500); or
 3. Alphanumeric Label (e.g. LAX FSS).
- ❑ To change the Memory display title, press the [ (0↔)] key repeatedly, if necessary, until you get the desired display title structure.
- ❑ To exit the Memory mode, press the **DIAL** selector knob three times to return to the VFO mode.

Note: In either the “MR” or the “Book” Memory mode, an easy way to recall memories is to key in the memory channel number, then press the [**SCAN (DW)**] key. For example, to recall memory channel #14, press [1] → [4] → [**SCAN (DW)**].

SCANNING OPERATION

The **FTA-310** allows you to scan automatically in the VFO^{※1}, Main Memory, “Book” Memory, or Weather Channel^{※2} modes. It pauses on signals encountered, so you can talk to the station(s) on that frequency, if you like.

※1: In the VFO mode, the automatic scanner is only available in the COM band (118.000 ~ 136.975 MHz); when the scanner reaches the uppermost frequency in the COM band, it will revert to the bottom end of the COM band and repeat the scanning process until you cancel the scanning process.

※2: USA version only.

If you wish to scan in the NAV band (108.000 ~ 117.975 MHz), you can do so manually, as described at the right.

Scanning operation is basically the same in each of the above modes.

- ❑ Press and hold in the [**SCAN (DW)**] key for 2 seconds to start the automatic scanner upward (toward a higher frequency or a higher channel number).

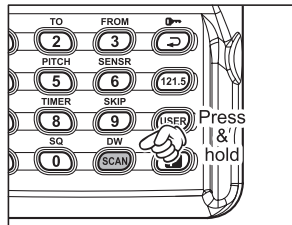

- ❑ When the scanner encounters a signal, scanning pauses and the radio remains on that channel until

one second after the signal disappears, after which scanning will resume.

- ❑ While the scanner remains paused on a frequency, the decimal point of the frequency display blinks. The display will be illuminated unless the Scan Lamp Feature is turned off.
- ❑ To change the scan direction, turn the **DIAL** selector knob *one click* in the opposite direction.
- ❑ To stop the automatic scanner, press the **PTT** switch or press downward on the **VOLUME** knob momentarily. You may also just press the [**SCAN (DW)**] key.

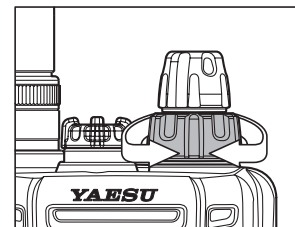

The **FTA-310**'s automatic scanner is not operational in the NAV band (108.000 ~ 117.975 MHz), because the NAV stations (ILS, etc.) transmit constantly (thereby causing the scanner to stop repeatedly). However, you can scan manually in the NAV band, per the following procedure:

- ❑ Press and hold the [**SCAN (DW)**] key to start the manual scanner. Scanning will continue as long as the key is depressed.
- ❑ Release the [**SCAN (DW)**] key to stop the manual scanner immediately.

SCANNING OPERATION

Note: When scanning upward in frequency, when the frequency reaches the COM Band (118.000 ~ 136.975 MHz) via manual scanning, the **FTA-310** will switch to the automatic scanner mode.

Channel-Skip Scanning

Continuous-carrier stations like ATIS (Automatic Terminal Information Service) or Weather Broadcast stations inhibit scanner operation. Since these stations are always active, the scanner will be halted repeatedly on their channels. Such channels can be set to be “skipped” during Memory scanning (MR, Book or WX modes), if you like, so as not to interfere with automatic channel scanning:

- ❑ Recall the Memory Channel to be skipped during scanning.
- ❑ Press the [F] key momentarily, then press the [9 (SKIP)]. The “**SKIP**” icon will appear at the upper right of the channel number, indicating that the channel is to be ignored during scanning.

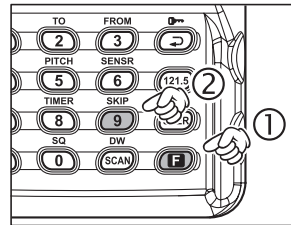

- ❑ You can also designate a channel to be skipped while scanning. When the receiver is halted on a channel that you wish to skip, press and hold the [SCAN (DW)] key for 2 seconds (the “**SKIP**” icon will appear next to the channel to be skipped).
- ❑ Later, to re-enable the memory channel for scanning, repeat the first two steps. The “**SKIP**” icon will disappear by the channel you have just re-enabled.

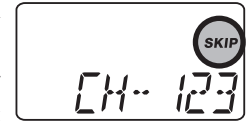

Note: A memory set to be “skipped” is still accessible for manual memory selection using the **DIAL** selector knob.

DUAL WATCH OPERATION

The Dual Watch feature automatically checks for activity on a “priority” channel[※] while you are operating on another channel. During Dual Watch operation, the current channel and the Priority channel will each be polled for a 500 ms interval, as the **FTA-310** looks for activity on each channel.

- ❑ To start Dual Watch, press the **[F]** key momentarily, then press the **[SCAN (DW)]**.

The “**DW**” icon will appear on the display.

- ❑ While receiving on the

“current” channel (not the Priority channel), you may push the **PTT** switch at any time to transmit on that channel.

- ❑ When a signal is received on the Priority channel, operation immediately shifts to the Priority channel, the “**DW**” icon will blink, and the display will become illuminated.
- ❑ While receiving on the priority channel, if you momentarily press the **PTT** switch, Dual Watch will be disabled. You may then transmit on the Priority Channel.

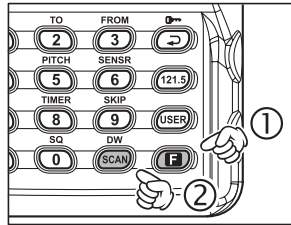

- ❑ To stop Dual Watch, press **[F] → [SCAN (DW)]**.
- ❑ If you wish, you may use both the Dual Watch and Scan features simultaneously. To do this, start the Dual Watch first, then start the Scanner.

※: The “priority” Channel is defined as the *last-used Memory Channel* (when using the VFO mode) or *Memory Channel 1* (when using the Main Memory or Book Memory modes).

PRIORITY DUAL WATCH OPERATION

Similar to Dual Watch operation (described on previous page), Priority Dual Watch is an enhanced version which includes the following additional features:

- The receiving time interval (ratio) between the current channel and the Priority channel may be customized via Menu Item 09 “PRTM.” See page 49 for details.
- Irrespective of which channel is currently being received, when the **PTT** button is pushed transmission will always occur on the Priority channel.

Before initiating Priority Dual Watch, Menu Item 10 “DWMD” must be set to the “PRI: Priority” mode (instead of “DW: Dual Watch”). See page 50 for details.

- ❑ To start Priority Dual Watch, press the **[F]** key momentarily, then press the **[SCAN (DW)]**. The “**DW**” icon will appear on the display.

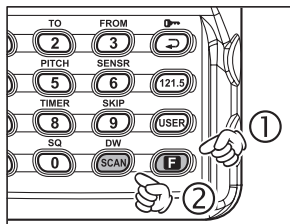

- ❑ While receiving on the “current” (non-Priority) channel, pressing the **PTT** button once causes the radio to switch to



the Priority channel and cancels Dual Watch. Press the **PTT** button again to transmit on the Priority channel.

- ❑ When a signal is received on the Priority channel, reception immediately shifts to the Priority channel, the “**DW**” icon will blink, and the display will become illuminated unless the Scan Lamp Feature is turned off.
- While receiving on the priority channel, if you momentarily press the **PTT** button, Priority Dual Watch will be disabled. You may then transmit on the Priority Channel.
- ❑ To stop Priority Dual Watch, press **[F] → [SCAN (DW)]**.

VOR NAVIGATION

General VOR Equipment

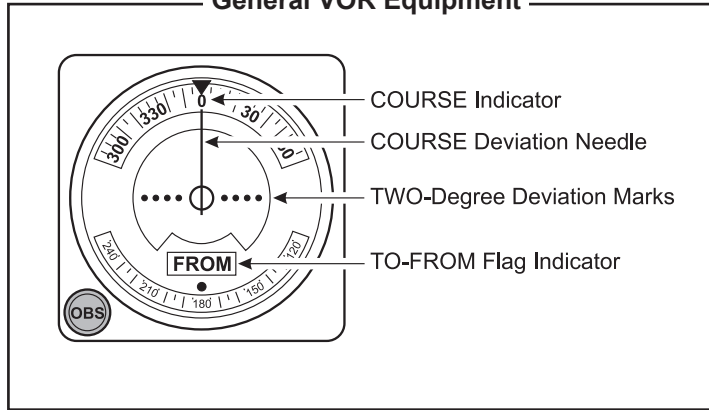

COM Band (118.000 - 136.975 MHz)



NAV Band (108.000 - 117.975 MHz)

DVOR MODE

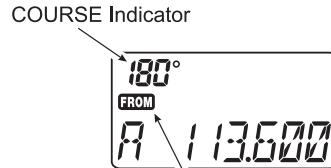

TO-FROM Flag Indicator

CDI MODE

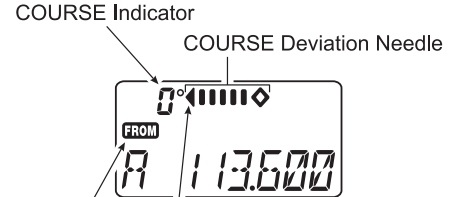

TO-FROM Flag Indicator
OVERFLOW Indicator

VOR NAVIGATION

To Select the DVOR Mode

- When entering the NAV band (108.000 - 117.975 MHz), the **FTA-310** selects the DVOR mode automatically. The “**COURSE INDICATOR**” field will appear at the upper left corner on the display, and the “**TO**” or “**FROM**” indicator will appear below the “Course Indicator” field on the display.

Note: The “**COURSE INDICATOR**” indicates “- - -” when either your aircraft is too far away from the VOR station or the frequency is not correctly set to that of the VOR station. Conversely, the “Course Indicator” will indicate “**LOC**” when receiving a localizer channel. The **FTA-310** cannot decode a localizer signal.

- The “**TO**” or “**FROM**” flag indicators tell you whether the VOR navigation information is based on a course leading to the VOR station or leading away from the VOR station.
- To change the flag from “**TO**” to “**FROM**” or vice versa, press the [F] key momentarily, then press the [3 (FROM)] or [2 (TO)] key, respectively.
- The small “**COURSE INDICATOR**” and “**TO/FROM**” flag indicators may be toggled to the larger “Frequency” portion of the display. To do this, press and hold in the [↩ (KEY)] key for 2 seconds to toggle to the larger display area. Press the [↩ (KEY)] key momentarily again to return to the smaller displays.

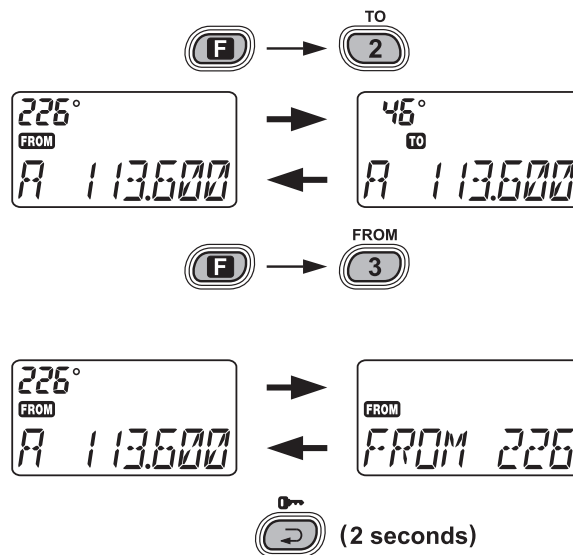
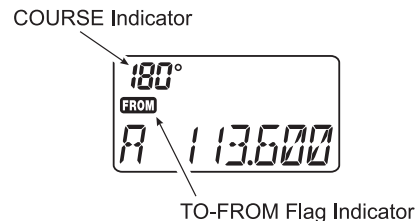

VOR NAVIGATION

Flying to a VOR Station

The **FTA-310** can indicate the deviation from the direct course to a VOR station.

- Select a VOR station on your aeronautical chart and turn the **DIAL** selector knob (or enter the frequency directly with the keypad) to the frequency of the VOR station.
- To indicate the deviation between your current flight path and the desired course, press the **[F]** key momentarily, then press the **[4 (CDI)]** key to change to the CDI (Course Deviation Indicator) mode. The “**COURSE DEVIATION ARROW**” will appear above the frequency field on the display when your aircraft is off the direct course to the VOR station.
- When your aircraft is off course to the right, the Course Deviation Arrow display will show bars to the left side of the diamond (“**III◇**”). When your aircraft is off course to the left, the Course Deviation Arrow display will show bars to the right side of the diamond (“**◇III**”). Correct your course until no bars appear on either side of the CDI “Diamond” (only “**◇**”) will be visible when the heading is correct).
- To return to the DVOR mode, press the **[F]** key momentarily, then press the **[1 (DVOR)]** key.

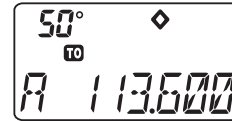

The Aircraft is "ON COURSE"

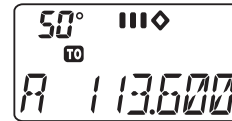

OFF COURSE to the "right" 6 degrees

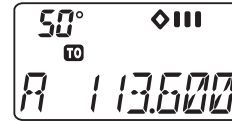

OFF COURSE to the "left" 6 degrees

VOR NAVIGATION

The Aircraft is "ON COURSE"

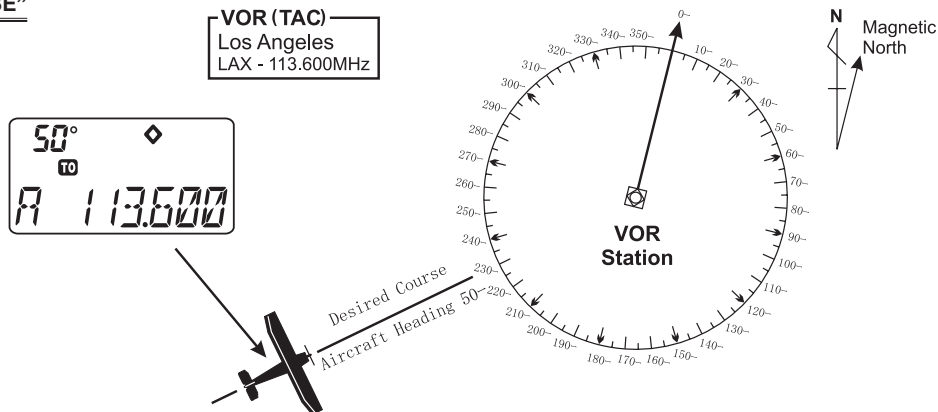

The Aircraft is "OFF COURSE"

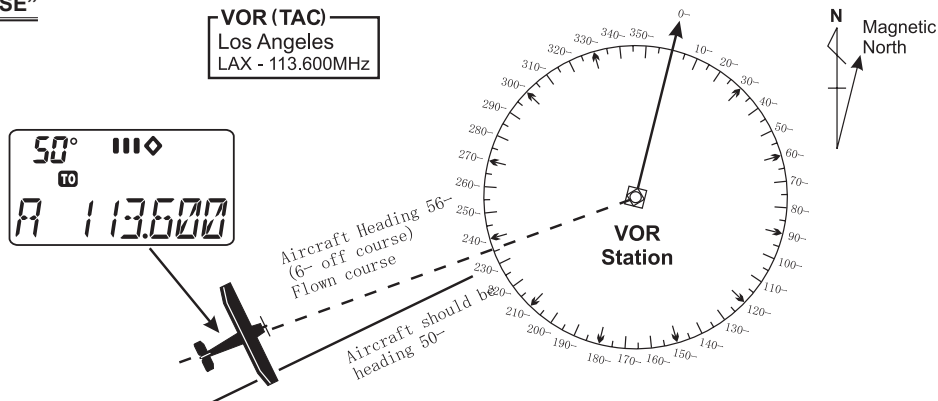

VOR NAVIGATION

Entering a Desired Course

The **FTA-310** can also be configured to indicate the deviation from the desired course, not only the deviation from the path to the VOR station.

- Set the frequency to the desired VOR station.
- Change the “**TO**” or “**FROM**” flag to “**TO**”, if it is not in that mode already.
- Press [**F**] → [**4 (CDI)**] key to change to the CDI mode.
- Set the desired course to the VOR station using the **DIAL** selector knob or keypad (three digits are required; e.g. for 47°, press [**0**] → [**4**] → [**7**]).

Note 1:

The (“**III**◆”) or (“◆**III**”) indication will appear on the display when your aircraft is off the desired course.

Note 2:

When your heading is correct, the ABCS function may be more useful than the course input option

- The Course Deviation Arrow points to the right when your aircraft is off course to the left, and it points to the left when your aircraft is off course to the right.

Note 1:

To get back on course, fly right more than the number of degrees indicated by the Course Deviation Arrow.

Note 2:

If the overflow indicator “▶” appears on the right side, select a heading plus 10 degrees to the desired course; if the overflow indicator “◀” appears on the left side, select a heading minus 10 degrees.

ABCS Mode

In the CDI mode, the Auto Bearing Center System (ABCS) adds or subtracts the number of degrees indicated by the CDI from the Omni Bearing Selector (OBS).

VOR NAVIGATION

Position Cross-checking

- ❑ Select two VOR stations on your aeronautical chart.
- ❑ Set the frequency of one of the VOR stations in the DVOR mode. The course indicator will show the course deviation from the VOR radial. Note the radial you currently are on.
- ❑ Now set the frequency of the other VOR station in the DVOR mode. Note the radial from the station you are on.
- ❑ Extend the radials from each VOR station on the chart. Your aircraft is located at the point where the lines intersect.

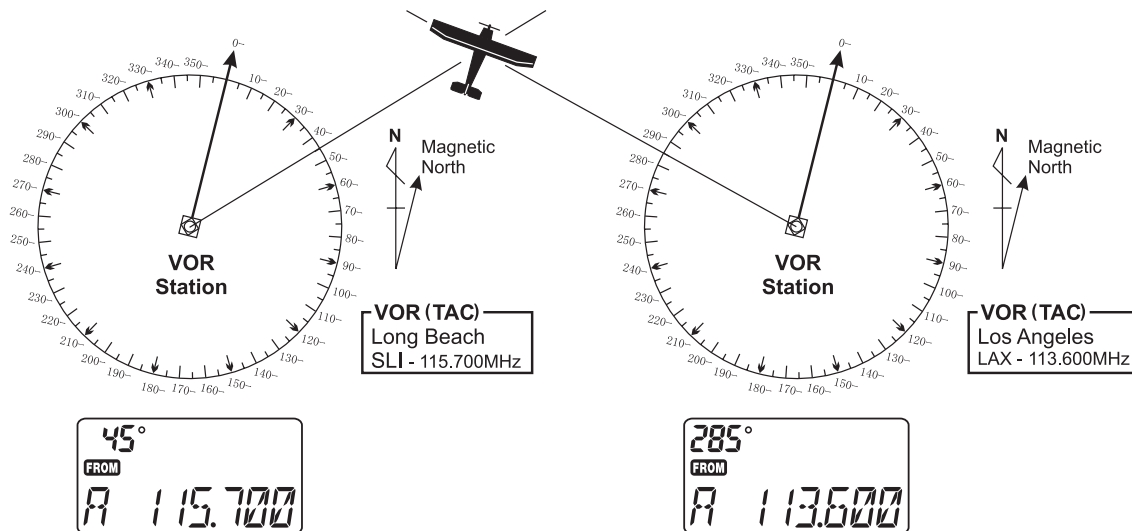

Cross-checking Position

VOR NAVIGATION

Split Operation

The split operation feature allows you to transmit a call to a Flight Service Station using the COM band frequencies, while receiving a VOR station (in the NAV band). VOR stations equipped with this capability typically are shown, on navigation charts, with the voice calling frequency in parenthesis above the navigation frequency.

Programming a Transmit Frequency

- ❑ Press downward on the **VOLUME** knob, repeatedly if necessary, to select the VFO mode.
- ❑ Set a NAV band (108.000 - 117.975 MHz) frequency using the **DIAL** selector knob or keypad.
- ❑ Press the [**F**] key momentarily, then press the [**MW (SPL-W)**] key. The “**SPL**” icon will blink, and the transmit frequency will appear on the display.
- ❑ Now set your radio’s transmit frequency, where the Flight Service Station will be listening for calls, using the **DIAL** selector knob or keypad.
- ❑ Press and hold in the [**MW (SPL-W)**] key for 2 seconds to save the transmit frequency and return to the NAV band frequency.

Note: You have now stored the separate transmit frequency, but you have not yet activated the split-frequency function; go on to the next section.

Operating in the Split Mode

- ❑ It is assumed that you have already set the desired VOR station’s frequencies (in the NAV band) per the above instructions.
- ❑ Press the [**F**] key momentarily, then press the [**7 (SPL)**] key to turn on the “Split” function. The “**SPL**” icon will appear on the display.
- ❑ Press and hold in the **PTT** switch to transmit on the split transmit frequency.
- ❑ Release the **PTT** switch to return to the receive mode.
- ❑ To disable the “Split” function, press [**F**] → [**7 (SPL)**] again.



Note: A split frequency can be programmed into each memory channel independently. Set a transmit frequency before programming the memory channel, if desired. The split function on/off setting can also be programmed into a memory channel.

PROGRAMMING THE USER KEY ASSIGNMENTS

Default **FTA-310** functions have been assigned to “Primary” (press) and “Third” (press and hold in) function of the front panel’s **[USER]** key at the factory. These may be changed by the user, if you wish to utilize another function on this key.

To program the function assigned to the **[USER]** key:

- Press the **[F]** key, then press downward on the **VOLUME** knob to activate the Menu (“SET”) mode.
- Rotate the **DIAL** knob to select the Menu Item to be configured #18 “KEY1” which is tied to the primary function, or #19 “KEY2” which is tied to the third function.

- Press downward on the **VOLUME** knob momentarily, then rotate the **DIAL** knob to select the function you wish to assign to the **[USER]** key.
- When you have made your selection, press downward on the **VOLUME** knob to save the new setting, then press the PTT switch to exit the Menu (“SET”) mode.

The available selections include: no/ANL/PA/EQ
ANL: Receiver Automatic Noise Limiter (on)
PA: Public Address Mode (see page 26)
PIT: Pitch Control (see page 24)
no: Disables the key

FIELD PROGRAMMING MODE

The **FTA-310**'s Book Memories also allow the user to store, label, and recall channel frequencies which you may want to use frequently while the **FTA-310** is in the Field Programming mode.

Memory Storage into the Book Memory

- Press and hold the **PTT** switch and **VOLUME** knob while turning the radio on, to activate the Field Programming Mode. The “Fd” icon will appear in the upper left-hand corner of the LCD to confirm that you are in the Field Programming mode.
- 
- The image shows a close-up of the LCD display. In the top-left corner, there is a circular icon containing the letters 'Fd'. Below and to the right of this icon, the display shows the letter 'A' followed by the frequency '128.800'.
- Select the desired frequency to be stored in the Book Memory.
 - Press and hold in the [**MW (SPL-W)**] key for 2 seconds. The display will indicate “- **BOOK -**” and a channel number will blink on the LCD.
 - Within five seconds of pressing the [**MW (SPL-W)**] key, rotate the **DIAL** selector knob to select the desired memory channel number for storage.

- Now press and hold in the [**MW (SPL-W)**] key for 2 seconds; you will now see a blinking “A” on the LCD. To attach an alpha/numeric name (label) to the memory, proceed to the next step; otherwise press and hold in the [**MW (SPL-W)**] key for 2 seconds to save the entry and exit.
- To label a memory with an alpha/numeric name, the next step is to use the **DIAL** selector knob to select any of the 48 available characters (including letters, numbers, and special symbols). When the desired first character appears, press down on the **VOLUME** knob momentarily to move on to the next character.
- Select succeeding characters in the same manner, pressing down on the **VOLUME** knob momentarily after each selection.
- After entering the entire name (eight characters maximum), press the [**MW (SPL-W)**] key for 2 seconds to save all data for the channel.
- Repeat this procedure to store additional frequencies into the Book Memory section, as desired.
- Turn the radio off, then turn the radio back on again to begin normal operation.

CPU RESETTING

In some instances of erratic or unpredictable operation, the cause may be corruption of data in the microprocessor (due to static electricity, etc.). If this happens, resetting of the microprocessor may restore normal operation. Note that all memories will be erased if you do a complete microprocessor reset, as described below.

To clear all memories and other settings to factory defaults:

- Turn the radio off.
- Press down and hold in the **VOLUME** knob, and the **MONITOR** button, while turning the radio on.

MENU (“SET”) MODE

The Menu system allows certain aspects of your radio’s configuration to be customized for your personal operating convenience. We do not recommend that any of the default settings be changed, however, until you are thoroughly familiar with the operation of the **FTA-310**.

1. Press the **[F]** key, then press down on the **VOLUME** knob to activate the Menu (“SET”) mode.

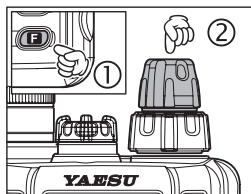

2. Rotate the **DIAL** selector knob to select the Menu item (feature) you wish to view and/or modify.

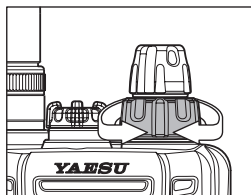

3. Once you have selected the desired Menu Item, press down on the **VOLUME** knob once to enable adjustment of this Menu item. The current setting value will be blinking.

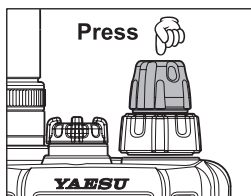

4. Rotate the **DIAL** selector knob to change the setting of the item (“on” to “oFF,” etc.).

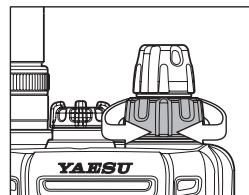

5. Press down on the **VOLUME** knob to save your new setting.

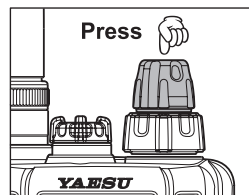

6. If you need to change more than one Menu item, repeat steps 2 - 5.
7. Press the **PTT** switch to exit the Menu (“SET”) mode.

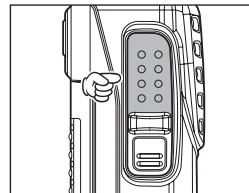

MENU Listing

A listing of the Menu items available via the SET mode may be found on the next page.

MENU (“SET”) MODE

Menu No.	Menu Item	Function	Available Values	Default
01	SQL	Squelch Level Setting.	0 ~ 8	6
02	MCLR	Memory Channel Clear (“MR” memory only).	–	–
03	RESM	Scan-Resume Mode Setting.	5S / CAR	5S
04	SCNL	Scan Lamp On/Off (while paused).	on / oFF	on
05	BEEP	Keypad Beeper On/Off.	on / DTM / oFF	on
06	RSVA	Selects the Receive-mode Battery Saver “sleep” ratio.	1:1 ~ 1:5 / oFF / ABS	1:1
07	LAMP	Display and Keypad Illumination Mode.	KEY / oFF / CNT	KEY
08	SFT	CPU Clock Shift.	on / oFF	oFF
09	PRTM	Selects the Priority Checking Time.	05 / 10 / 15 / 20 / 25 / 30	20
10	DWMD	Selects the Dual Watch/Priority Function.	DW / PRI	DW
11	POBP	Select the Power on Beep.	MD1 / MD2 / MD3 / oFF	MD1
12	IMIC	Internal Microphone On/Off.	on / oFF	oFF
13	EMRG	Emergency channel On/Off.	on / oFF	on
14	TEMP	Correcting the thermometer setting.	–127 ~ +127	000
15	UNIT	Selects the measurement units for the temperature sensor.	°F / °C	°F
16	TOT	Setting of the Time-Out Timer countdown time.	1 / 3 / 5 / oFF	oFF
17	DIMM	Setting of the display brightness level.	LV1 ~ LV4	LV3
18	KEY1	Programming the primary (<i>momentary press</i> mode) [USER] key assignment.	no / ANL / PA / PIT	ANL
19	KEY2	Programming the third (<i>press and hold</i> mode) [USER] key assignment.	no / ANL / PA / PIT	PA
20	WXAF	Selects the Alert functions when receiving the Weather Alert Signal on the WX channel.	BP / LED / B+L / oFF	oFF
21	VOX	Enables/disables VOX operation.	on / oFF	oFF
22	VDLY	Selects the VOX delay (“hang”) time.	05 / 10 / 15 / 20	10
23	VSNS	Sets the VOX sensitivity.	1 ~ 8	4
24	HPLV	Sets the Headphone audio level.	0 ~ 7	6
25	PAMO	Enables/disables the External Speaker while utilizing the PA function.	oFF / PA / ALL	oFF
26	UP_L	Sets the low-frequency audio response for the user-customized receiver audio tone pitch control.	+ / – / oFF	+
27	UP_M	Sets the mid-range audio response for the user-customized receiver audio tone pitch control.	+ / – / oFF	oFF
28	UP_H	Sets the high-frequency audio response for the user-customized receiver audio tone pitch control.	+ / – / oFF	–
29	LOCK	Selects the control locking lockout combination.	K / KD / P / PD / PK / PKD / D	K
30	STEP	Selects the synthesizer steps on the Air band.	25 kHz / 8 kHz (8.33 kHz)	25 kHz
31	PIT	Selects the Tone Pitch (equalizer) circuit of the audio amplifier in the receiver.	oFF / MD1 / MD2 / MD3 / USR	MD1

MENU (“SET”) MODE

01 [SQL]

Function: Squelch Level Setting.

Available Values: 0 ~ 8

Default Setting: 6

Select a setting for this Menu item which just silences the receiver when no signal is present. Use the lowest setting which will keep the receiver quiet between incoming transmissions.

02 [MCLR]

Function: Memory Channel Clear (“MR” memory only).

To clear a Memory channel:

- Select the Menu Item MCLR.
- Press down on the **VOLUME** knob, then rotate the **DIAL** selector knob to recall the memory channel to be erased.
- Press down on the **VOLUME** knob to clear the Memory channel (the Memory channel number will return to “001”).

Important Notice: An “erased” channel cannot be restored, and “CH-001” cannot be erased, as it is used for “Priority Channel” operation.

03 [RESM]

Function: Scan-Resume Mode Setting.

Available Values: 5S/CAR

Default Setting: 5S

“5S” (5-Second Pause) mode: the scanner will halt for five seconds only, after which scanning will resume (whether or not the other station is still transmitting).

“CAR” (Carrier Drop) mode: the scanner will remain halted for as long as there is a carrier present on the channel; after the carrier drops at the end of the other station’s transmission, the scanning will resume.

04 [SCNL]

Function: Scan Lamp On/Off (while paused).

Available Values: on/oFF

Default Setting: on

If you set this function to “on,” the lamp will be illuminated whenever the scanner pauses. The lamp will go off automatically when scanning resumes.

MENU (“SET”) MODE

05 [BEEP]

Function: Keypad Beeper On/Off.

Available Values: on/DTM/oFF

Default Setting: on

on: Sounds a beep corresponding to a musical note.

DTM: Sounds a beep corresponding to a DTMF tone.

off: Disables the key beeper.

If you do a lot of scanning, you may wish to set this Menu item to “oFF,” as the Beeper will be heard each time the scanner pauses.

06 [RSAV]

Function: Selects the Receive-mode Battery Saver “sleep” ratio.

Available Values: 1:1 ~ 1:5/oFF/ABS*

Default Setting: 1:1

The setting of 1:5 will promote the greatest conservation of battery capacity, but the receiver’s response time to incoming calls will be slowed somewhat.

* ABS: Automatic Battery Saver, based on activity on the receiver.

Note: This feature does not operate during Scan or Dual Watch.

07 [LAMP]

Function: Display and Keypad Illumination Mode.

Available Values: KEY/oFF/CNT

Default Setting: KEY

“KEY” mode: The illumination lamp will be activated for 5 seconds when any front panel key or the **VOLUME** knob is pressed, or if the **DIAL** knob is rotated.

“oFF” mode: Disables the illumination lamp.

“CNT” mode: Illuminates the Display/Keypad continuously.

08 [SFT]

Function: CPU Clock Shift.

Available Values: on/oFF

Default Setting: oFF

This function is only used to move a spurious response “birdie” should it fall on a desired frequency. Consult your YAESU dealer for details regarding this function.

09 [PRTM]

Function: Selects the Priority Checking Time.

Available Values: 05/10/15/20/25/30 (0.5/1/1.5/2/2.5/3 sec.)

Default Setting: 20 (2 seconds)

This Menu item allows you to define how often the Priority Channel will be checked for activity.

Note: The Dual Watch Polling time is 500 mS (fixed).

MENU (“SET”) MODE

10 [DWMD]

Function: Selects the Dual Watch/Priority Function.

Available Values: DW/PRI

Default Setting: DW

“DW” mode: The **FTA-310** will activate the Dual Watch feature when you press [F] → [**SCAN (DW)**].

“PRI” mode: The **FTA-310** will activate the Priority feature when you press [F] → [**SCAN (DW)**].

11 [POBP]

Function: Select the Power on Beep.

Available Values: MD1/MD2/MD3/oFF

Default Setting: MD1

Note: You will hear the different selections as you rotate the **DIAL** selector knob.

12 [IMIC]

Function: Internal Microphone On/Off.

Available Values: on/oFF

Default Setting: oFF

This controls the status of the radio’s internal microphone when an external microphone (such as the **MH-44B4B** Speaker Microphone or an aviation headset connected via the **CT-96** Headset Cable) is in use. In most applications, set 12 [IMIC] to “oFF” for proper operation (this disables the internal microphone). The internal microphone will still function normally when the external microphone is disconnected.

13 [EMRG]

Function: Emergency channel On/Off.

Available Values: on/oFF

Default Setting: on

This controls the operation of the Emergency [**121.5**] key. When set to “oFF,” this key will not function. You can still use the frequency 121.5 MHz either by entering it on the keypad in the VFO mode, or by recalling it on a previously-stored memory channel.

MENU (“SET”) MODE

14 [TEMP]

Function: Correcting the thermometer setting.

Available Values: -127 ~ +127 (x0.1 °C)

Default Setting: 000 (°C)

This allows you to calibrate the internal thermometer with a known-to-be-accurate source.

15 [UNIT]

Function: Selects the measurement units for the temperature sensor.

Available Values: °F/°C

Default Setting: °F

16 [TOT]

Function: Setting of the Time-Out Timer countdown time.

Available Values: 1/3/5/oFF (minutes)

Default Setting: oFF

The Time-Out Timer shuts off the transceiver after continuous transmission exceeds the programmed time.

17 [DIMM]

Function: Setting of the display brightness level.

Available Values: LV1 ~ LV4

Default Setting: LV3

18 [KEY1]

Function: Programming the primary (*momentary press* mode) [USER] key assignment.

Available Values: no/ANL/PA/PIT

Default Setting: ANL (Automatic Noise Limiter)

See page 43 for details.

19 [KEY2]

Function: Programming the third (*press and hold* mode) [USER] key assignment.

Available Values: no/ANL/PA/PIT

Default Setting: PA (Public Address)

See page 43 for details.

MENU (“SET”) MODE

20 [WXAF]

Function: Selects the Alert functions when receiving the Weather Alert Signal on the WX channel.

Available Values: BP/LED/B+L/oFF

Default Setting: oFF

BP: Sounds a loud beep when receiving the Weather Alert Signal.

LED: Flashes the **BUSY/TX** indicator when receiving the Weather Alert Signal.

B+L: Sounds a loud beep and flashes the **BUSY/TX** indicator when receiving the Weather Alert Signal.

oFF: Disables the Alert function.

When the Weather Alert function is activated, the “**(A)**” icon will appear on the display.

21 [VOX]

Function: Enables/disables VOX operation.

Available Values: on/oFF

Default Setting: oFF

22 [VDLY]

Function: Selects the VOX delay (“hang”) time.

Available Values: 05/10/15/20 (x0.1 sec)

Default Setting: 10 (x0.1 sec)

23 [VSNS]

Function: Sets the VOX sensitivity.

Available Values: 1 ~ 8

Default Setting: 4

24 [HPLV]

Function: Sets the Headphone audio level.

Available Values: 0 ~ 7

Default Setting: 6

25 [PAMO]

Function: Enables/disables the External Speaker while utilizing the PA function.

Available Values: oFF/PA/ALL

Default Setting: oFF

oFF: Disables the monitor function at all times.

PA: Feeds back your voice to the headset while you’re pressing the **PTT** switch.

ALL: Feeds back your voice to the headset while you’re pressing the **PTT** switch. When the **PTT** switch is off, you may monitor the sound around the transceiver (the monitor will pick up the background sound using the **FTA-310**’s internal microphone).

MENU (“SET”) MODE

26 [UP_L]

Function: Sets the low-frequency audio response for the user-customized receiver audio tone pitch control.

Available Values: +/-/oFF

Default Setting: +

27 [UP_M]

Function: Sets the mid-range audio response for the user-customized receiver audio tone pitch control.

Available Values: +/-/oFF

Default Setting: oFF

28 [UP_H]

Function: Sets the high-frequency audio response for the user-customized receiver audio tone pitch control.

Available Values: +/-/oFF

Default Setting: –

29 [LOCK]

Function: Selects the control locking lockout combination.

Available Values: K/KD/P/PD/PK/PKD/D

Default Setting: K

K: Keypad (includes pressing the **VOLUME** knob function)

D: **DIAL** selector knob

P: **PTT** switch

(Other selections are combinations of these lock-out choices)

30 [STEP]

Function: Selects the synthesizer steps on the Air band.

Available Values: 25 kHz/8 kHz (8.33 kHz)

Default Values: 25 kHz

31 [PIT]

Function: Selects the tone pitch circuit of the audio amplifier in the receiver.

Available Values: oFF/MD1/MD2/MD3/USR

Default Values: MD1

oFF: The received audio signal does not pass through the tone pitch circuit.

MD1: The received audio is passed without roll-off on the high or low ends.

MD2: The received audio is enhanced in the low- and mid-range frequencies.

MD3: The received audio is enhanced in the mid- and high-range frequencies.

USR: The received audio is shaped per a user-configured audio response programmed via Menu Items 26 “UP_L,” 27 “UP_M,” and 28 “UP_H.” The default setting enhances the audio in the lower frequency range, and reduces the level of the higher-frequency components.

SPECIFICATIONS

General

Frequency Range:	TX: 118.000 - 136.975 MHz RX: 108.000 - 136.975 MHz, Weather Channels (WX-01 - WX-10: USA version only)
Channel Spacing:	25 kHz/8.33 kHz (8.33 kHz: RX only)
Emission Type:	TX: AM RX: AM & FM (FM: for receiving the Weather Channels, USA version only)
Supply Voltage:	6.0 - 15.0 VDC
Current Consumption (approx.):	20 μ A (power off), 20 mA (battery saver on, saver ratio 1:5) 60 mA (squelch on), 270 mA (receive), 0.9 A (transmit 1.5 W Carrier)
Temperature Range:	+14 °F to +140 °F (-10 °C to +60 °C)
Case Size (WxHxD):	2.4 x 4.7 x 1.2 inches (60 x 120 x 32 mm) with FNB-83
Weight (approx.):	13.7 oz (390 grams) with FNB-83 and antenna

Receiver

Circuit Type:	Double-conversion superheterodyne
IFs:	35.4 MHz & 450 kHz
Sensitivity:	Better than 0.8 μ V (for 6 dB S/N with 1 kHz, 30 % modulation)
Selectivity:	>8 kHz/-6 dB
Adjacent CH. Selectivity:	<25 kHz/-60 dB
AF Output (@7.2 V):	0.8 W @ 16 Ohms, 10 % THD

SPECIFICATIONS

Transmitter

Power Output (@ 7.2 V):	5.0 W (PEP), 1.5 W (Carrier Power)
Frequency Stability:	Better than ± 10 ppm (+14 °F to + 140 °F [-10 °C to +60 °C])
Modulation System:	Low Level Amplitude Modulation
Spurious Emission:	>60 dB below carrier
Int. Microphone Type:	Condenser
Ext. Mic. Impedance:	150 Ohms

Specifications are subject to change without notice or obligation.

TROUBLESHOOTING

QUESTION	ANSWER
When connecting the CT-96 headset cable between the radio and a headset, the red transmit LED on the radio turns on and the radio cannot be operated.	This happens when the connector on the CT-96 headset cable is simply pushed into the MIC/EAR jack. The jack must be screwed into the MIC/EAR jack to make proper contacts within the radio.
Can I purchase the optional PTT Switch from Yaesu?	Contact your Aviation dealer for details on purchasing an aftermarket Push-To-Talk switch.
Will my headset work with this radio?	The CT-96 headset cable is made to operate with most headsets; however to be concretely sure check with the headset manufacturer providing the wiring shown below. Please confirm the connections and connector sizes are correct.

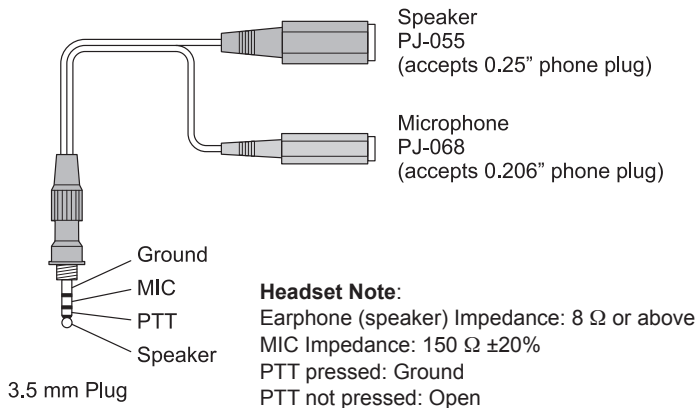

BOOK MEMORY CHANNEL LIST (USA VERSION: FACTORY DEFAULT)

CH No.	ALPHA TAG	FREQUENCY (MHZ)	NOTE	CH No.	ALPHA TAG	FREQUENCY (MHZ)	NOTE
1	AIR-AIR	123.450	Unofficial Air-Air	31	ARTCC 07	136.175	Air Traffic Control General Use
2	AIR-AIR	131.800	Air to Air	32	ARTCC 08	136.225	Air Traffic Control General Use
3	ARINC 01	136.500	Aeronautical Enroute Channel	33	ARTCC 09	136.250	Air Traffic Control General Use
4	ARINC 02	136.525	Aeronautical Enroute Channel	34	ARTCC 10	136.300	Air Traffic Control General Use
5	ARINC 03	136.550	Aeronautical Enroute Channel	35	ARTCC 11	136.325	Air Traffic Control General Use
6	ARINC 04	136.575	Aeronautical Enroute Channel	36	ARTCC 12	136.350	Air Traffic Control General Use
7	ARINC 05	136.600	Aeronautical Enroute Channel	37	ARTCC 13	136.400	Air Traffic Control General Use
8	ARINC 06	136.625	Aeronautical Enroute Channel	38	ARTCC 14	136.425	Air Traffic Control General Use
9	ARINC 07	136.650	Aeronautical Enroute Channel	39	ARTCC 15	136.450	Air Traffic Control General Use
10	ARINC 08	136.675	Aeronautical Enroute Channel	40	FAS	122.000	Enroute Flight Advisory Service
11	ARINC 09	136.700	Aeronautical Enroute Channel	41	FOREST	122.925	Forest Management
12	ARINC 10	136.725	Aeronautical Enroute Channel	42	FSS	123.600	Flight Service Station
13	ARINC 11	136.750	Aeronautical Enroute Channel	43	HLC AIR	123.025	Helicopter Air to Air
14	ARINC 12	136.775	Aeronautical Enroute Channel	44	INTL G/C	130.700	International Gulf/Caribbean
15	ARINC 13	136.800	Aeronautical Enroute Channel	45	INTL NY	129.900	International New York
16	ARINC 14	136.825	Aeronautical Enroute Channel	46	INTL SF	131.950	International San Francisco
17	ARINC 15	136.850	Aeronautical Enroute Channel	47	MIL TWR	126.200	Military Tower
18	ARINC 16	136.875	Aeronautical Enroute Channel	48	RESCUE	123.100	Search and Rescue
19	ARINC 17	136.900	Aeronautical Enroute Channel	49	RESCUE T	122.900	Training Search and Rescue
20	ARINC 18	136.925	Aeronautical Enroute Channel	50	SCHOOL 1	123.300	Flight Schools
21	ARINC 19	136.950	Aeronautical Enroute Channel	51	SCHOOL 2	123.500	Flight Schools
22	ARINC 20	136.925	Aeronautical Enroute Channel	52	UNICOM 1	122.700	Unicom-Airports without towers
23	ARINC 21	136.950	Aeronautical Enroute Channel	53	UNICOM 2	122.725	Unicom-Private Airports
24	ARINC 22	136.975	Aeronautical Enroute Channel	54	UNICOM 3	122.750	Unicom-Air to Air
25	ARTCC 01	136.000	Air Traffic Control General Use	55	UNICOM 4	122.800	Unicom-Airports without towers
26	ARTCC 02	136.025	Air Traffic Control General Use	56	UNICOM 5	122.950	Unicom-Airports with towers
27	ARTCC 03	136.050	Air Traffic Control General Use	57	UNICOM 6	123.000	Unicom-Airports without towers
28	ARTCC 04	136.075	Air Traffic Control General Use	58	UNICOM 7	123.050	Unicom-Heliports
29	ARTCC 05	136.125	Air Traffic Control General Use	59	UNICOM 8	123.075	Unicom-Heliports
30	ARTCC 06	136.150	Air Traffic Control General Use	-	---	---	---

BOOK MEMORY CHANNEL LIST (EXP VERSION: FACTORY DEFAULT)

CH No.	ALPHA TAG	FREQUENCY (MHZ)	NOTE	CH No.	ALPHA TAG	FREQUENCY (MHZ)	NOTE
1	AMS VMT	126.200	AMSTERDAM MET BROADCAST	42	WAW VMT	127.600	WARSAW VOLMET
2	ANK VMT	127.000	ANKARA (ESENBOGA MET BROADCAST)	43	ZRH VMT	127.200	ZURICH MET
3	ATH VMT	127.800	ATHENS(ATHINAI VOLMET)	50	AMS ATIS	132.975	AMSTERDAM(Schiphol)
4	BCN VMT	127.600	BARCELONA	51	AMS ATIS	122.200	AMSTERDAM(Schiphol)
5	BEG VMT	126.400	BELGRADE VOLMET	52	ESB ATIS	123.600	ANKARA(Esenboga)
6	BER VMT	128.400	BERLIN VOLMET	53	ATH ATIS	123.400	ATHENS
7	BOO VMT	124.250	BODO VOLMET	54	BCN ATIS	118.650	BARCELONA
8	BOD1 VMT	126.400	BORDEAUX RADIO	55	BEG ATIS	119.500	BELGRADE
9	BOD2 VMT	127.000	BORDEAUX RADIO	56	TXL ATIS	125.900	BERLIN(Tegel)
10	BRU VMT	127.800	BRUSSELS	57	BOO ATIS	123.900	BODO
11	BUH VMT	126.800	BUCHAREST VOLMET	58	BOD ATIS	131.150	BORDEAUX(Merignac)
12	BUD VMT	127.400	BUDAPEST VOLMET	59	BRU ATIS	132.475	BRUSSELS(National)
13	CPH VMT	127.000	COPENHAGEN VOLMET	60	OTP ATIS	118.500	BUCHAREST(Otopeni)
14	DUB VMT	127.000	DUBLIN VOLMET	61	BUD ATIS	124.650	BUDAPEST(Ferihegy)
15	FRA1 VMT	127.600	FRANKFURT 1 VOLMET	62	FRA ATIS	118.025	FRANKFURT(Main)
16	FRA2 VMT	135.775	FRANKFURT 2 VOLMET	63	GVA ATIS	135.575	GENEVA(Cointrin)
17	GVA VMT	126.800	GENEVA MET BROADCAST	64	CPH ATIS	122.750	COPENHAGEN(Kastrup)
18	HEL VMT	128.400	HELSINKI VOLMET	65	CPH ATIS	122.850	COPENHAGEN(Kastrup)
19	INN VMT	130.475	INNSBRUCK (NATIONAL VOLMET INNSBRUCK AUSTRIA)	66	DUB ATIS	124.525	DUBLIN
20	IST VMT	127.400	ISTANBUL(ATATURK MET BROADCAST)	67	LGW ATIS	136.525	LONDON(Gatwick)
21	LPA VMT	126.200	LAS PALMAS VOLMET	68	LHR ATIS	123.900	LONDON(Heathrow)
22	LIS VMT	126.400	LISBON(LISBOA VOLMET)	69	HEL ATIS	135.075	HELSINKI(Vantaa)
23	LON1 VMT	135.375	LONDON VOLMET(MAIN)	70	INN ATIS	126.025	INNSBRUCK
24	LON2 VMT	128.600	LONDON VOLMET(SOUTH)	71	IST ATIS	128.200	ISTANBUL(Ataturk)
25	LON3 VMT	126.600	LONDON VOLMET(NORTH)	72	FBU ATIS	126.125	OSLO(Fornebu)
26	MAD VMT	126.200	MADRID VOLMET	73	CDG ATIS	128.000	PARIS(Charles de Gaulle)
27	MRS1 VMT	127.400	MARSEILLE RADIO	74	ORY ATIS	126.500	PARIS(Orly)
28	MRS2 VMT	128.600	MARSEILLE RADIO	75	PRG ATIS	122.150	PRAGUE(Ruzyně)
29	MIL VMT	126.600	MILAN(MILANO VOLMET)	76	FCO ATIS	121.700	ROME(Fiumicino)
30	MOW VMT	127.875	MOSCOW VOLMET	77	MAD ATIS	118.250	MADRID(Barajas)
31	OSL VMT	128.600	OSLO VOLMET	78	MRS ATIS	125.350	MARSEILLE(Provence)
32	PAR1 VMT	126.000	PARIS RADIO	79	SVO ATIS	126.375	MOSCOW(Sheremetievo)
33	PAR2 VMT	125.150	PARIS RADIO	80	VKO ATIS	125.875	MOSCOW(Vnukovo)
34	PRG VMT	128.600	PRAGUE VOLMET	81	LED ATIS	127.400	ST. PETERBURG(Pulkovo)
35	ROM VMT	126.000	ROME VOLMET	82	SOF ATIS	124.050	SOFIA
36	LED VMT	125.875	ST. PETERSBURG VOLMET	83	ARN ATIS	119.000	STOCKHOLM(Arlanda)
37	SOF VMT	126.600	SOFIA VOLMET	84	ARN ATIS	121.625	STOCKHOLM(Arlanda)
38	STO VMT	127.600	STOCKHOLM VOLMET	85	TLV ATIS	132.500	TEL AVIV(Ben Gurion Intl)
39	SDL VMT	127.800	SUNDSVALL VOLMET	86	VIE ATIS	122.950	VIENNA(Schwechat)
40	TLV VMT	126.800	TEL AVIV(BEN GURION RADIO)	87	WAW ATIS	120.450	WARSAW(Okęcie)
41	VIE VMT	126.000	VIENNA(VOLMET WIEN AUSTRIA)	88	ZRH ATIS	128.525	ZURICH

Quick Reference

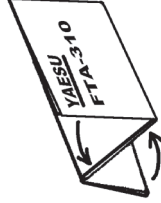
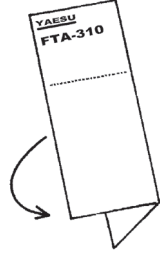
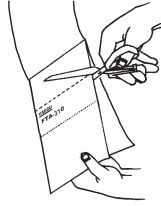

(Cut Here)

YAESU
The radio

FTA-310

Quick Reference Card

YAESU MUSEN CO., LTD.

Memory Programming

Select the desired frequency in the VFO mode, or recall the "Book" Memory channel or Weather channel to be stored in the Main Memory.

1. Press and hold in the [MW(SPL-W)] key.
2. Rotate the DIAL selector knob to select the desired memory channel number for storage.
3. Press and hold in the [MW(SPL-W)] key.
4. Rotate the DIAL selector knob to select any of the character.
5. When the desired first character appears, Press downward on the VOLUME knob momentarily to move on to the next character.
6. After entering the entire name (eight characters maximum), press the [MW(SPL-W)] key for 2 seconds to save all data for the channel and exit.

Tag Channels (Memory Display)

1. Press downward on the VOLUME knob several times to select -MR- mode.
2. Press the [↔(MR)] key, then press the [6] key to change Memory display.

Mode Selection

Press downward on the VOLUME knob to switch the operating mode between the VFO mode, Memory mode, Book mode and WX mode.

Lock Function

Press the [F] key, Then press the [↔(MR)] key.

VOR Navigation

1. Select the VOR station frequency.
2. Press [F] key, then press [0] or [FROM] key to change flag.
3. Press and hold in the [↔(MR)] key for 2 seconds, course indicator display to toggle between the small display and the larger display area.
4. Press [F] key, then press [4/CDI] key to select CDI mode.

Fly to a VOR station

1. Select a VOR station on your aeronautical chart and turn the DIAL selector knob (or enter the frequency directly with the keypad) to the frequency of the VOR station.
2. Select the “TO” flag when flying to the VOR station or select the “FROM” flag when flying away from the VOR station.
3. Press [F] key, then press [4/CDI] key to select CDI mode. The course indicator shows “OFF” when the VOR signal can not received.
4. Press and hold in the [↵(←→)] key for 2 seconds to change the “COURSE INDICATOR” display size.

Field Programming Mode

1. Press and hold in both the PTT switch and VOLUME knob, while turning the radio on.
2. Select the desired frequency to be stored in the Book Memory.
3. Press and hold in the [MW(SPL-W)] key for 2 seconds.
4. Rotate the DIAL selector knob to select the desired memory channel number for storage.
5. Press and hold in the [MW(SPL-W)] key for 2 seconds. To attach an alpha/numeric name (label) to the memory, proceed to the next step; otherwise press and hold in the [MW(SPL-W)] key for 2 seconds to save the entry and exit.
6. To label a memory with an alpha/ numeric name, the next step is to use the DIAL selector knob to select any of the 48 available characters.
7. Press the VOLUME knob momentarily to select it and move on to the next character.
8. After entering the entire name (eight characters maximum), press the [MW(SPL-W)] key for 2 seconds to save all data for the channel.
9. Turn the radio off, then turn the radio back on again to begin normal operation.

Part 15.21: Changes or modifications to this device
not expressly approved by YAESU MUSEN could
void the user's authorization to operate this device.

YAESU

The radio

YAESU MUSEN CO., LTD.

Tennozu Parkside Building
2-5-8 Higashi-Shinagawa, Shinagawa-ku, Tokyo 140-0002 Japan

YAESU USA

6125 Phyllis Drive, Cypress, CA 90630, U.S.A.

YAESU UK

Unit 12, Sun Valley Business Park, Winnall Close
Winchester, Hampshire, SO23 0LB, U.K.

YAESU HK

Unit 2002, 20/F, 9 Chong Yip Street,
Kwun Tong, Kowloon, Hong Kong

1211M-AY

Copyright 2012
YAESU MUSEN CO., LTD.
All rights reserved.

No portion of this manual may be
reproduced without the permission of
YAESU MUSEN CO., LTD.

Printed in Japan



EC057N151