

YAESU

Radio for Professionals

C4FM/FM 144/430MHz
DUAL BAND DIGITAL TRANSCEIVER

FTM-500DR

FTM-500DE



Operating Manual



Contents

Introduction	1	Using the optional Dash Mount Bracket	
Quick Guide	2	“MMB-103”.....	34
Supplied Accessories and Options	2	Using the optional Swing Head kit	
Basic Operation	4	“SJMK-500”.....	34
Turning the Transceiver ON.....	4	Using a Micro SD Memory Card	36
Adjusting the volume.....	5	Mounting and Dismounting	
Adjusting the squelch level.....	5	microSD Memory Card.....	36
Selecting a Frequency Band.....	5	Formatting a Micro SD Memory Card.....	36
Tuning to a Frequency.....	6	Functions to use as needed	37
Switch between Main Band and Sub Band.....	7	Selecting the Communication Mode.....	37
Transmitting.....	7	Fixing the Communication Mode.....	38
Locking the Keys and DIAL knob.....	7	Changing the Transmit Power Level.....	38
Useful Functions	8	Setting the Skip Band.....	39
① CFL: Custom Function List.....	8	Changing the Frequency Step.....	39
② PMG (Primary Memory Group).....	9	Change the frequency display color	
③ Band Scope.....	10	of the operation band.....	39
④ Memory auto grouping (MAG) function.....	10	Using the convenient Digital C4FM features...	40
⑤ VFO Band skip function.....	10	About the Digital Group ID (DG-ID) feature.....	40
⑥ Memory channel → VFO copy.....	10	Communicating with the DG-ID feature.....	40
Setup Menu List.....	11	Repeater Operation	43
Switch between Dual receive and		Using the Memory	44
Scope operation with one touch	12	Writing to memory.....	44
Dual Receive.....	12	Recall memory (There are two ways).....	45
Scope Screen.....	12	Copy memory channel information to VFO.....	46
Change the number of channels		Recall only memories in the same	
displayed during scope operation.....	12	frequency band (Band) using the memory	
Search & Go (Short press).....	13	auto grouping (MAG) function.....	47
Touch & Go (Long press).....	13	Edit memory.....	48
Quick Back function.....	13	Recalling the Home Channels.....	50
PMG (Primary Memory Group)	14	Changing the Home Channel Frequency.....	50
Register the frequency to PMG.....	14	Split Memory.....	51
Using PMG function.....	14	Scanning Function	52
Unregister the Channel (Frequency)		VFO Scan / Memory Scan.....	52
registered in PMG.....	14	Setting the Receive Operation	
Normal Mode (Manual Mode).....	15	When Scanning Stops.....	52
Auto Mode.....	15	Skip Memory Channels.....	53
CFL (Customized Function List)	16	Programmable Memory scan (PMS).....	53
Registration to the Function List.....	17	Convenience Features	54
Cancel registration in the Function List.....	17	Bluetooth® Operation.....	54
AESS (Acoustic Enhanced Speaker System)	18	VOX Operation.....	56
Name and function of each component	19	Dual Receive Function.....	60
Control Head (front).....	19	Using the Voice Recorder.....	61
Control Head (top).....	21	GPS Function.....	64
Control Head (Left and right side).....	22	WIRES-X function.....	64
Control Head (rear).....	22	APRS (Automatic Packet	
Main body.....	23	Reporting System) function.....	64
Microphone (SSM-85D).....	24	Tone squelch feature.....	65
Display.....	26	Digital Code squelch (DCS) feature.....	65
Descriptions of Main Screens.....	28	New PAGER (EPCS) feature.....	65
About this manual	30	Digital Personal ID (DP-ID) feature.....	65
Safety Precautions (Be Sure to Read)	31	Using Setup Menu	66
Installing the Radio	33	Tables of Setup Menu Operations	67
About the antenna.....	33	Restoring to Defaults (Reset)	74
Connection of Antenna and Power Cables.....	33	Text input screen	75
Installing the Transceiver/Microphone.....	34	Specifications	76
Install the main body using the		YAESU LIMITED WARRANTY	78
supplied bracket.....	34		

Features of the Yaesu FTM-500DR/DE Transceiver.

- Equipped with a front speaker. The AESS dual speaker system uses the main body speaker in combination the front panel speaker to provide clear audio quality and spacious 3D sound.
- Total audio output is 9W (3W: main body, 6W: control head) High sound quality, loud speakers.
- The latest operating system E2O-IV (Easy to Operate-IV) affords a new operating feeling with dual mobile “Touch & Go” and “Search & Go” functions.
- The Primary Memory Group Activity Monitor (PMG) function can register up to 5 channels with the receive frequencies of the VFO or memory channels by simply pressing and holding the  key. Press the  key to scan the registered frequencies and display the reception status (signal strength) in a real time bar graph.
- Digital communication using Yaesu (C4FM (Quaternary FSK) system)
- Simultaneous reception of two separate frequencies, on different bands, or within the same band (V+V/U+U/V+U/U+V).
- Equipped with AMS (Automatic Mode Select) feature that automatically selects the analog FM or the C4FM digital modes, according to the signal of the other station.
- The DG-ID (Digital Group ID) feature, and the Group Monitor (GM) feature enable automatically locating, and communicating with other stations that are within contact range and have the matching DG-ID number, (Group ID number from 00 to 99).
- The 2.4-inch High-Resolution QVGA Full-Color TFT Display shows the communication status and settings of the FTM-500DR/DE in a straightforward manner, achieving excellent operability.
- Swing head function allows adjusting the control head angle upward by about 20 degrees.
- The Custom Function List (CFL) can be personalized by registering frequently used functions (up to 8) from the 127 items Setup Menu.
- Memory Channel Band Auto Grouping (MAG). The memory channels are automatically categorized in each band, so that memory channels can be easily and quickly recalled.
- VFO band skip function can be set to hide the unused bands.
- High-resolution band scope that displays 61 channels
- The Super DX function temporarily increases the receiver sensitivity.
- Wide-band reception (108 MHz to 999.99 MHz) (USA Cellular Blocked)
- Built-in GPS unit permits display of the current location and heading information
- Equipped with Bluetooth® function as standard. Supports hands-free communication using the optional Bluetooth® headset SSM-BT10 or a commercially available product.
- Large-capacity 1104 memory channels
- Heavy Duty-Heat Sink with FACC (Funnel Air-Convection Conductor)
- WIRES-X Portable Digital Node or Fixed Node with HRI-200
- Equipped with digital GM (Group Monitor) function
- Ready for APRS® communication with world standard 1200 / 9600bps AX25 modem
- Compatible with microSD memory cards

Thank you for purchasing the FTM-500DR/DE Transceiver. We urge you to read this manual in its entirety, and also the Advance Manual (available for download on the Yaesu website), to gain a full understanding of the amazing capability of the exciting new FTM-500DR/DE Transceiver.

WIRES-X, GM function and APRS instruction manuals are not included in the product package. They are available and may be downloaded from the Yaesu.com website.

Quick Guide

① Turn the Power ON

Press and hold the [POWER(LOCK)] switch.

② Input the Call sign

When turning the power ON for the first time after purchasing, input the call sign of your own station.

Input call sign may be changed from Setup Menu [120 CALLSIGN].

1. When turning the power ON for the first time after purchasing, the call sign input screen will be displayed.

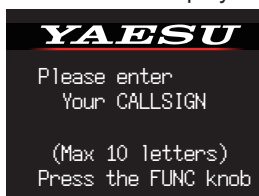

2. Press the **FUNC** knob (upper right).

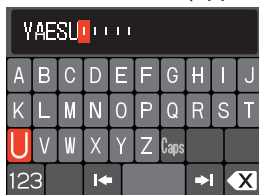

3. Input the call sign.
Touch the characters on the screen, or rotate the **FUNC** knob to select each character and then press the **FUNC** knob.

: to move the cursor to the right.

: to move the cursor to the left.

: change to the numeric and symbol input

: to delete character to left of cursor

See "Text input screen" on page 75 to input a call sign.

4. Repeat step 3 to input the remaining call sign characters.
5. Press and hold the **FUNC** knob to conclude inputting.

The power is turned OFF once and then turned on automatically. Normal operation (VFO Mode) screen will be displayed.

③ Select the Operating Band

Press the key.

④ Tune the frequency

Rotate the **DIAL** knob.

⑤ Adjust the volume

Rotate the **VOL/SQL** knob to adjust the volume to a comfortable level.

⑥ Adjust the squelch setting

The squelch level may be adjusted to mute the background noise when no signal is received.

1. Press the **VOL/SQL** knob.
2. Rotate the **VOL/SQL** knob to adjust the squelch to a level at which the background noise is muted.

*When the squelch level is increased, the noise is more likely to be silenced, but it may become more difficult to receive weak signals.

3. Press the **VOL/SQL** knob again or wait for about 3 seconds to complete the adjustment.

⑦ Select the communication mode

In the factory settings, the communication mode automatically corresponds to the signal being received.

* Press the key or touch the mode area on the display to manually select the communication mode.

⑧ Transmit/Receive Signals

Talk into the microphone while holding the **PTT** switch on the side. Release the **PTT** switch to return to receive.

⑨ Set the Bluetooth® function

The FTM-500DR/DE is equipped with the Bluetooth function. To use a Bluetooth headset, refer to "Bluetooth® Operation" on page 54 for setting.

Supplied Accessories and Options

Supplied Accessories

- DTMF microphone SSM-85D
- DC power cable (with fuse attached)
- Bracket for main body
- Spare fuse (15A)
- Operating Manual (This Manual)



If any item is missing, contact the dealer from which you purchased the transceiver.

Available Options

- | | |
|--|----------|
| • Swing Head Kit | SJMK-500 |
| • Dash Mount Bracket | MMB-103 |
| • Control Cable 20ft (6m) | CT-132 |
| • Control Cable 10ft (3m) | SCU-62 |
| • Mic Extension Kit 10ft (3m) for SSM-85D and MH-42C6J | MEK-5 |
| • WIRES-X Connection Cable kit | SCU-58 |
| • Voice Guide Unit | FVS-2 |
| • DTMF Microphone | SSM-85D |
| • Microphone | MH-42C6J |
| • Bluetooth® Headset | SSM-BT10 |
| • High-Power External Speaker | MLS-100 |

Basic Operation

Turning the Transceiver ON

1. Press and hold the **POWER (LOCK)** switch to turn the transceiver **ON / OFF**.

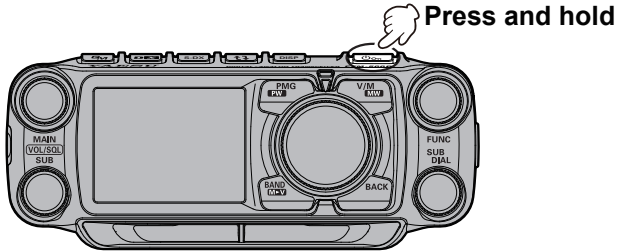

● Inputting the call sign

1. The first time the transceiver is turned ON after it is purchased; input your own call sign.
2. Press the **FUNC** knob to proceed to the call sign input screen.
 - When the transceiver is subsequently turned ON, the opening screen appears followed by the frequency screen.
 - The input call sign may be changed from the Setup Menu [121 CALLSIGN].
3. Touch or rotate the **FUNC** knob, then press it to select each character.

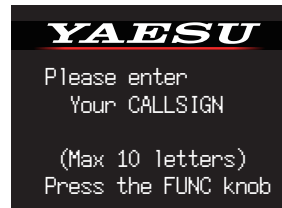

- : to move the cursor to the right.
- : to move the cursor to the left.
- : change to the numeric and symbol input
- : delete the character left of the cursor



Up to 10 characters (letters, numbers, and a hyphen) can be entered.

4. Repeat step 3 to input the remaining call sign characters.
5. Press and hold the **FUNC** knob to conclude inputting. Normal operating (VFO Mode) screen will be displayed.

Adjusting the volume

1. Rotate the **VOL** knob to adjust the volume to a comfortable level.

Adjust the volume for
Main Band (upper)

Adjust the volume for
Sub Band (lower)

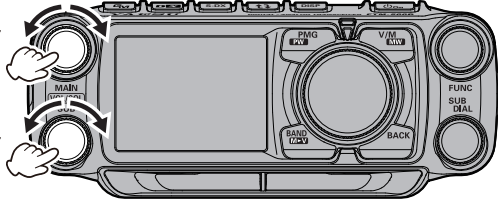

Adjusting the squelch level

Annoying noises can be muted when a signal cannot be detected. Normally, use the factory settings, but adjust the squelch if noise is harsh.

1. Press the **VOL/SQL** knob, and then rotate the **FUNC** knob to adjust to a level at which the background noise is muted.

Adjust the squelch level
for Main Band (upper)

Adjust the squelch level
for Sub Band (lower)

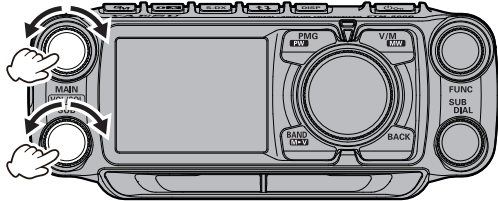

- **SQL**  appears on the display.
 - Adjustment is possible for Main band and Sub band.
2. After the adjustment, press the **VOL/SQL** knob again, or do nothing for about 3 seconds, the SQL meter will return to the VOL meter.





When the squelch level is increased, the noise is more likely to be silenced, but it may become more difficult to receive weak signals.

Selecting a Frequency Band

Press the  key to select the desired frequency band.

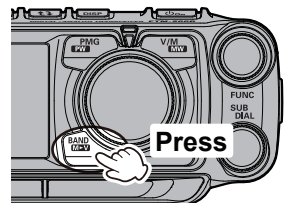
AIR Band	108MHz - 137MHz
144MHz Band	137MHz - 174MHz
VHF Band	174MHz - 400MHz
430MHz Band	400MHz - 480MHz
UHF Band	480MHz - 999.995MHz



- With the "band skip function", specific bands may be selected to be used. Even when the band skip is set so that some frequencies cannot be selected, frequently used frequencies can be recalled by saving them into the memory channels before setting band skip.
- In the VFO mode, press and hold the  key → rotate the **FUNC** knob to select the band to set → press the **FUNC** knob to select the band → rotate the **FUNC** knob to select "ON" (selectable) or "OFF" (not selectable)

Tuning to a Frequency

- 1 Press the **BAND LOCK** key to select the desired frequency band.
- 2 Rotate the **DIAL** knob to select the desired frequency.

AIR Band 108MHz - 137MHz
 144MHz Band 137MHz - 174MHz
 VHF Band 174MHz - 400MHz
 430MHz Band 400MHz - 480MHz
 UHF Band 480MHz - 999.995MHz

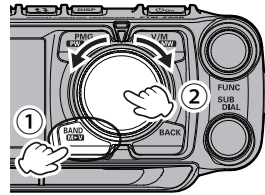

● Keyboard frequency entry (Direct Input)

1. Press and hold the **DIAL** knob, to display the frequency input screen.
Or press the **FUNC** knob → **[KEYPAD]** → press the **FUNC** knob.
2. The leftmost digit will blink, then turn the **DIAL** knob to select the first digit.
3. Press the **DIAL** knob, the second digit will blink.
4. Rotate the **DIAL** knob to select the second digit.
5. Repeat the same operation to select additional digits.
Then press and hold the **DIAL** knob to conclude the input and confirm the frequency.

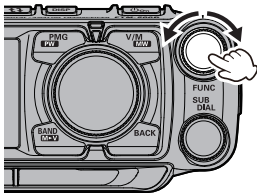
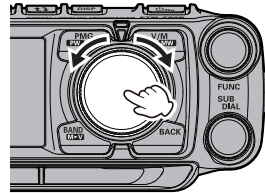

KEYPAD	HOME CH
SCAN	TXPWR HIGH
SQL OFF	ARS AUTO
RPT-R	STONE 100.0
DTMF	APRS OFF
>	



While entering a frequency using the keyboard, the entry may be canceled by pressing the **BACK** key.

● Change the frequency rapidly (MHz up/down function)

Press the **DIAL** knob, to blink the MHz digit.

Change the frequency in 1MHz steps by turning the **DIAL** knob while it is blinking.



In this case, change the frequency within the range of 108MHz to 999.995MHz regardless of the band. Operation will be within the band that includes the input frequency.

See below for details on operating bands.

108MHz - 137MHz	→ AM mode*
137MHz - 174MHz	→ Digital or FM mode
174MHz - 300MHz	→ FM mode*
300MHz - 320MHz (for USA: 336MHz)	→ AM mode*
320MHz (for USA: 336MHz) - 400MHz	→ FM mode*
400MHz - 480MHz	→ Digital or FM mode
480MHz - 999.995MHz	→ FM mode*

*Change to AM or FM mode in the Set Menu **[16 RX MODE]**.

● The numeric keys on microphone

Press the numeric keys “0” to “9” to enter the frequency.

Example: To input 145.520 MHz

[1] → [4] → [5] → [5] → [2]

Example: To input 430.000 MHz

[4] → [3] → [Press and hold any numeric key]



While entering a frequency using the numeric keys, the entry may be canceled by pressing **PTT**.



Switch between Main Band and Sub Band

The two operational bands are displayed on the top and bottom of the touch screen. The upper display band can transmit.



Press the microphone [P1] key (factory default) to transmit on the SUB Band frequency (at the bottom of the screen).

Each time the  key is pressed, the operating band switches between “Upper” and “Lower”.

The upper display is called the “Main band”, and the lower display is called the “Sub band”.

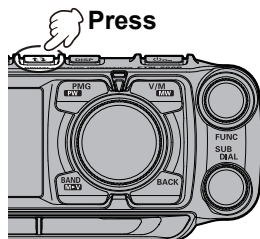

Transmitting



1. While pressing and holding **PTT**, speak into the microphone.
2. Release the PTT to return to receive.

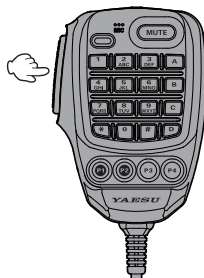

- If the **PTT** switch is pressed when a frequency other than the amateur ham radio band is selected, an alarm tone (beep) will be emitted, “**TX PROHIBIT**” appears on the display, and transmit is disabled.
- If transmission is continued for a long period, the transceiver overheats, and the high temperature protection function is activated. As a result, the transmitting power level is automatically set to Low Power. If transmission continues while the high temperature protection function is active, the transceiver will be forcibly returned to the receive mode.



Locking the Keys and DIAL knob

1. Press the  switch, “**LOCK**” is shown on the display for one second, the “” icon appears on the display, and then the keys and **DIAL** knob are locked.

Press the  switch again, “**UNLOCK**” will be shown on the Display and the keys and the **DIAL** knob are unlocked.

The “” icon disappears.



The **PTT** switch and the VOL/SQL knob cannot be locked.

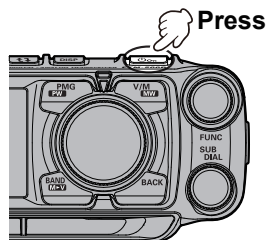

Useful Functions

① CFL: Custom Function List page 16

From 127 items of the Setup Menu, frequently used functions in the Function List can be registered and then recalled by simply pressing the **FUNC** knob. The Function List screen displays the registered functions and current settings in an easy-to-read form, so you can immediately select and use the function. By default, 10 functions are registered in the Custom Function List. Up to 8 frequently used functions can be registered and customized in the Function List.

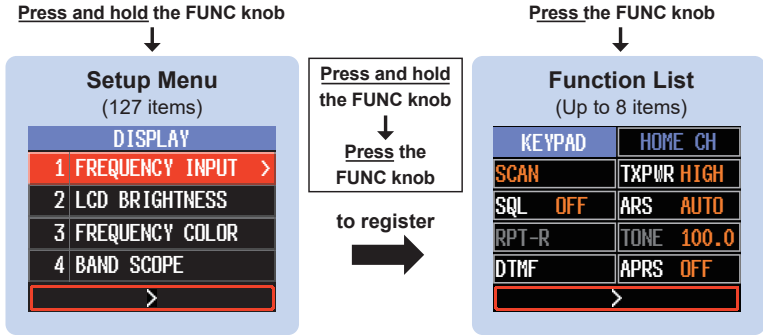

The "KEYPAD" and "HOME CH" displayed at the top of the screen cannot be changed.

● Registration to the Custom Function List

Press and hold the **FUNC** knob to display the setup menu, select the item to be registered with the **FUNC** knob, then press and hold the **FUNC** knob. Select the list position to register the setup item with the **FUNC** knob, and then press the **FUNC** knob to register it in the setup menu.

● Use the Function List

Press the **FUNC** knob to display the function list screen, and select the function to be used with the **FUNC** knob or touch it on the screen. By pressing the **FUNC** knob, you can execute functions or change settings.

● Cancel registration to Function List

On the function list screen, select the function to cancel with the **FUNC** knob or touch it on the screen. Press and hold the  key to cancel the registration.

Press and hold: to register in the function list

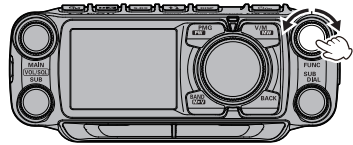

Turn the **FUNC** knob to select, then press the **FUNC** knob.

Press: to recall

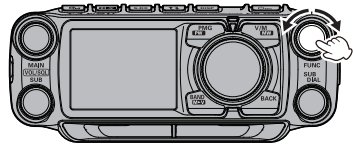

Turn the **FUNC** knob to select, then press the **FUNC** knob.

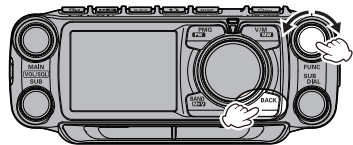

Press and hold: to cancel registration



② **PMG (Primary Memory Group)** **page 14**

The PMG function that displays the receive status of registered channels in a bar graph allows registration of up to 5 channels by pressing and holding the  key for the current display frequency of either the VFO or the memory channel. The PMG screen can be switched to auto mode or manual mode by press and hold the **DIAL** knob.

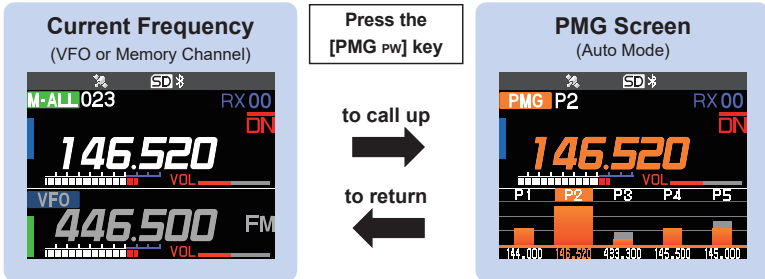
PMG channels are continuously scanned in auto mode. If a signal is received on other than the current channel, the frequency will automatically blink and dual receive will occur. When the signal disappears or the screen is touched, PMG scanning resumes. When operating on a blinking frequency (channel), touch and hold the blinking frequency to switch it to the operating channel



Auto mode scans and receives simultaneously on channels with signals.

- **Register the frequency to PMG**
Display the frequency of the VFO or memory channel, then press and hold the  key. The frequency is registered in PMG.
- **Display the PMG screen**
Press the  key to display the PMG screen.

Press and hold the **DIAL** knob to switch between Auto Mode and Manual Mode.

Auto Mode:
Scan and receive simultaneously on channels with signals. When there is no signal, scanning is resumed and the receive status is displayed in real time.

Manual Mode:
It is fixed to the channel selected by the **DIAL** knob, and when there is a signal, the received audio is output. When there is no signal on the selected channel, it scans and displays the receive status of other channels in real time. (Even if there is a signal on another channel, the received audio is not output.)

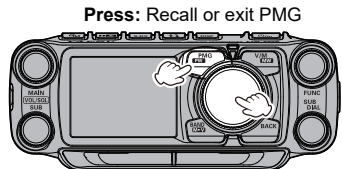
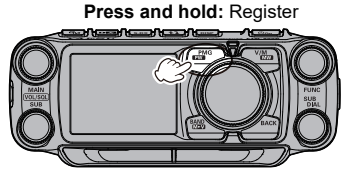

Rotate the **DIAL** knob to select
Press and hold the **DIAL** knob to switch Auto Mode / Manual Mode

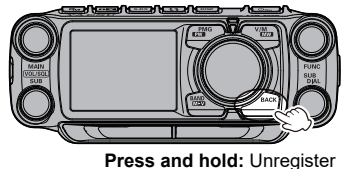

- **Cancel the frequency registered in PMG**
Select a channel on the PMG screen and press and hold the  key.

③ Band Scope page 12

The receive status (signal strength) of the channels before and after the current frequency can be displayed as a bar graph, whether in VFO mode or in memory mode.

Press the **DISP** key to display the band scope screen. When the desired channel is set to the center with the **DIAL** knob, the received audio is played.

Press: Displays the band scope

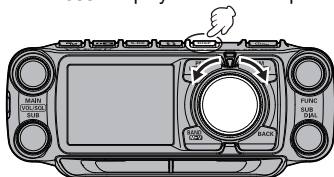

Rotate the **DIAL** knob to select the channel

④ Memory auto grouping (MAG) function page 47

Memory channels can be automatically grouped and recalled for each band.

Press the **BAND** key in memory mode. In the memory mode, each time the **BAND** key is pressed, only memory channels of the specified frequency band are automatically recalled as a group, as shown below:

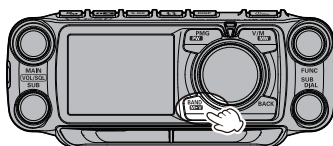

Press: Select the band to display in memory mode

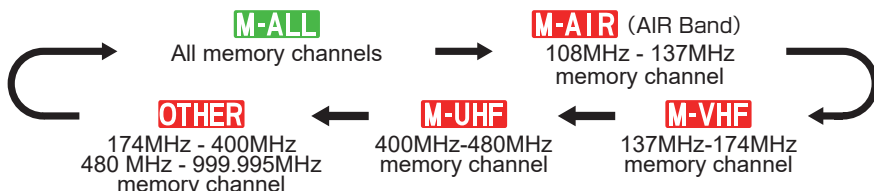

⑤ VFO Band skip function page 39

Bands that are not normally used can be skipped when the **BAND** key is pressed.

In VFO mode, press and hold the **BAND** key, select the band you want to set with the **FUNC** knob, and press the **FUNC** knob.

Then turn the **FUNC** knob to set "ON" (selectable) / "OFF" (not selectable).

You can still recall from All Memory Channels a frequency that is saved in the band set to be skipped.

Press and hold: Display the band select screen

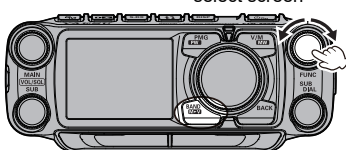

Turn **DIAL** to select a band
Press **DIAL** to select ON/OFF

⑥ Memory channel → VFO copy page 46

Transfers the recalled memory channel to the VFO with one-touch operation.

Press and hold the **BAND** key while recalling a memory channel to transfer the memory channel information to the VFO and switch to VFO mode.

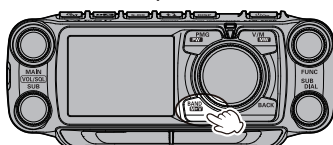

Press and hold: Copy to VFO in memory mode

Setup Menu List

Frequently used items from the below 127 Setup Menu types, can be registered to the Function List. (See page 16) The gray Setting items are registered in the Function List by factory default. See page 66 for detail information on the Setup Menu.

DISPLAY	SIGNALING	
1 FREQUENCY INPUT (Fixed)	43 DTMF	85 BEACON TX SET
2 LCD BRIGHTNESS	44 DTMF MEMORY	86 DIGI PATH
3 FREQUENCY COLOR	45 SQL TYPE	87 DIGI PATH 1
4 BAND SCOPE	46 TONE SQL FREQ / DCS CODE	88 DIGI PATH 2
5 LOCATION INFO	47 SQL EXPANSION	89 DIGI PATH 3
6 COMPASS	48 PAGER CODE	90 DIGI PATH 4
7 DISPLAY MODE	49 PR FREQUENCY	91 DIGI PATH FULL 1
TX	50 BELL RINGER	92 DIGI PATH FULL 2
8 TX POWER	51 WX ALERT	93 CALLSIGN (APRS)
9 AMS TX MODE	SCAN	94 MESSAGE GROUP
10 MIC GAIN	52 SCAN	95 MESSAGE REPLY
11 VOX	53 DUAL RCV MODE	96 MY POSITION SET
12 AUTO DIALER	54 DUAL RX INTRVAL	97 MY POSITION
13 TOT	55 PRIORITY REVERT	98 MY SYMBOL
14 DIGITAL VW	56 SCAN RESUME	99 POSITION COMMENT
RX	DIGITAL	100 SmartBeaconing
15 FM BANDWIDTH	57 DIGITAL POPUP	101 SORT FILTER
16 RX MODE	58 LOCATION SERVICE	102 VOICE ALERT
17 SUB BAND	59 STANDBY BEEP	103 STATION LIST
18 AUDIO EQUALIZER	GM	104 MESSAGE LIST
MEMORY	60 DP-ID LIST	105 BEACON TX SELECT
19 HOME CH (Fixed)	61 RANGE RINGER	106 BEACON TX
20 MEMORY LIST	62 RADIO ID	SD CARD
21 MEMORY LIST MODE	63 LOG LIST	107 BACKUP
22 PMG	WIRES-X	108 MEMORY INFO
CONFIG	64 RPT/WIRES FREQ	109 FORMAT
23 BEEP	65 SEARCH SETUP	OPTION
24 BAND SKIP	66 EDIT CATEGORYTAG	111 Bluetooth
25 RPT ARS	67 DELETE ROOM/NODE	112 VOICE MEMORY (Requires FVS-2)
26 RPT SHIFT	68 WIRES DG-ID	113 FVS REC
27 RPT SHIFT FREQ	DATA	114 TRACK SELECT
28 RPT REVERSE	69 COM PORT	115 FVS PLAY
29 MIC PROGRAM KEY	70 DATA BAND	116 FVS STOP
30 DATE&TIME ADJUST	71 DATA SPEED	117 FVS CLEAR
31 DATE&TIME FORMAT	72 DATA SQL	118 VOICE GUIDE
32 TIME ZONE	APRS	CLONE
33 STEP	73 APRS DESTINATION	119 This → Other
34 CLOCK TYPE	74 APRS FILTER	120 Other → This
35 UNIT	75 APRS MSG TEXT	RESET
36 APO	76 APRS MODEM	121 CALLSIGN
37 GPS DATUM	77 APRS MUTE	122 MEMORY CH RESET
38 GPS DEVICE	78 APRS POPUP	123 APRS RESET
39 GPS LOG	79 APRS RINGER	124 CONFIG SET
AUDIO	80 APRS RINGER (CS)	125 CONFIG RECALL
40 RECORDING	81 APRS TX DELAY	126 SOFTWARE VERSION
41 REC/STOP	82 APRS UNITS	127 FACTORY RESET
42 FRONT SP MUTE	83 BEACON INFO	
	84 BEACON STATUSTXT	

Switch between Dual receive and Scope operation with one touch

Dual receive and Scope operations are switched each time the  key is pressed.

The center frequency or memory channel can be changed by turning the **DIAL** knob.

In VFO Mode, press and then turn the **DIAL** knob to select the frequency in 1MHz increments.

In Memory Mode, press and then turn the **DIAL** knob to select in 10 channel steps.

Dual Receive

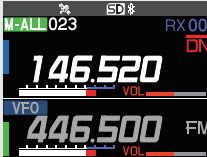



Scope Screen

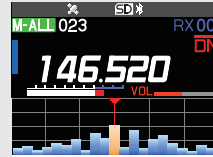

Dual Receive

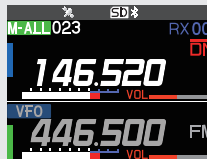

- In Dual receive, both Main and Sub frequencies are received at the same time, and the volume is adjusted with each **VOL/SQL** knob.

Switch the Main and Sub frequencies with the  key.

Scope Screen

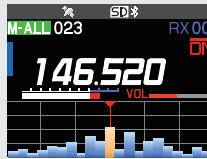

- Scope operation allows monitoring other frequencies on the Sub-display while receiving the Main frequency.

The status (strengths) of the signals in the upper and lower frequency channels (61CH or 31CH), or memory channels (21CH or 11CH) are displayed on the Scope Bar graph, centered on the current operating channel.

Change the number of channels displayed during scope operation

- Press and hold the **FUNC** knob → Touch [4 BAND SCOPE] → Rotate the **FUNC** knob to select the setting.

Search & Go (Short press)

- Touch on the Scope screen, Bar graph to access SUB VFO dual receive.

Scope Screen



Touch the bar

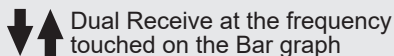

Dual Receive at the frequency touched on the Bar graph
Dual Receive on the scope screen



Touch to return to the previous screen

Scope Screen

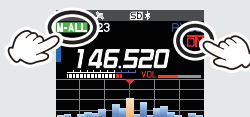

Change operation to, VFO mode or, Memory mode

Touch & Go (Long press)

- Long touch on the Scope screen Bar graph to rewrite the Main VFO.
- On the Dual Receive screen, long touch on the blinking area to rewrite the Main VFO.
- On the scope screen, long touch on the frequency area to display the frequency input screen.

Scope Screen

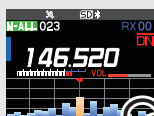

Long touch the bar

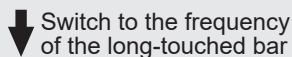

Scope Screen



Dual Receive on the scope screen



Long touch the blinking area

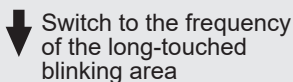

Scope Screen

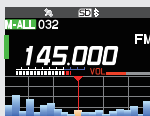

Scope Screen

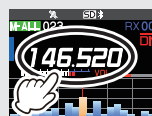

Long touch the frequency area

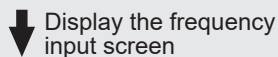

Frequency input Screen

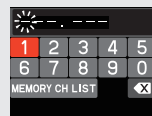

Quick Back function

- When tuning from the current operating frequency to another frequency, pressing the  key within 5 seconds will automatically return to the previous frequency. (Does not work with PMG.)

PMG (Primary Memory Group)

PMG Function

The PMG function allows the status of multiple channels to be displayed in real time on the Bar Graph, while listening to the Receive Channel. In manual mode, turn the DIAL knob to select the Receive Channel, and also observe the status of other channels on the Bar Graph.





Register the frequency to PMG

- Press and hold the  key to register the current frequency in PMG.
- Up to 5 channels can be registered in PMG.

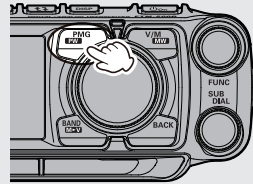



Up to 5 channels can be registered in PMG. When registering more than five Frequencies, older frequencies will be deleted in order from PMG.



- Press and hold the  key on the PMG operation screen, then rotate the DIAL knob, to change the registered frequency. To return to the PMG operation screen, use one of the following methods:
Returns to the frequency before change → Press the  key or  key.
Register the changed frequency and return → Press and hold the  key.

Using PMG function: Press the key

Rotate the DIAL knob to select the desired Channel from the Channels registered in PMG.

- If there are **no** registered Channels in PMG, the PMG screen will not be displayed even if the  key is pressed.
- To adjust the squelch during PMG operation, press the VOL/SQL knob for the Main Band and turn it. The adjustment is reflected in all channels registered in PMG. When receiving simultaneously on the PMG screen, the squelch on the upper screen is adjusted with the VOL/SQL knob for the Main Band, and the squelch on the lower screen is adjusted with the VOL/SQL knob for the Sub Band.
- Press and hold the  key on the PMG screen to copy the contents of the currently selected PMG channel to the VFO, then enter VFO mode.
- Press the frequency display (digital mode only) on the upper screen to display the compass with the distance and direction to the other station. Press the compass display to return to the PMG screen.



Unregister the Channel (Frequency) registered in PMG

1. Select the channel (frequency) to be unregistered by rotating the **DIAL** knob.
2. Press and hold the  key to cancel the registration.



- Cancel all frequency (channels) registered in PMG.
1. Press and hold the FUNC knob → [22 PMG] → [PMG CLEAR].
 2. Press the **FUNC** knob.

Normal Mode (Manual Mode)

- Displays the current received signal in orange.
- Displays historical received signal strengths in gray (Press the **DIAL** knob to reset).
- Press the blinking area of the screen during Dual Receive, Dual Receive will be canceled and the original PMG function will be restored.

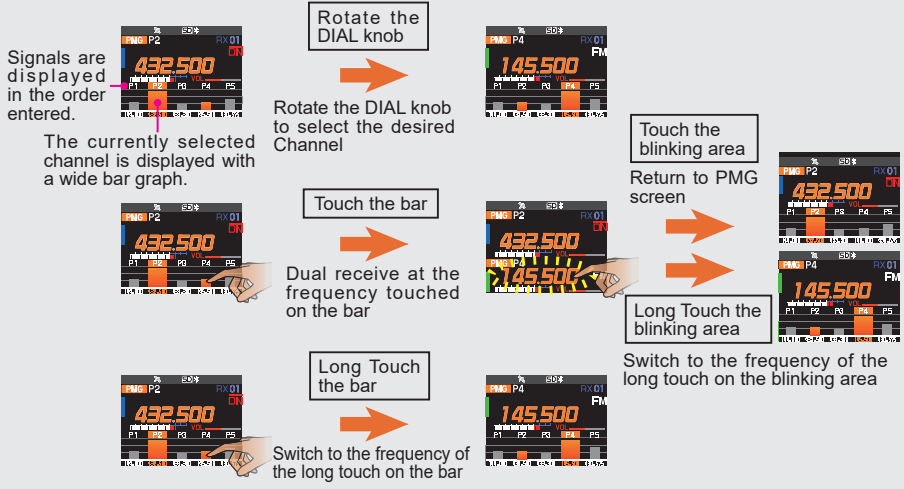

Press and hold the **DIAL** knob while the PMG function is operating to enter PMG Auto Mode. PMG Auto Mode automatically starts Dual Receive when a new signal is received on another channel while the current Operating Channel is being received. In PMG Auto Mode, automatically listen to the new signal that appears on another channel in Dual Receive while also receiving the current Operating Channel, without looking at the screen.

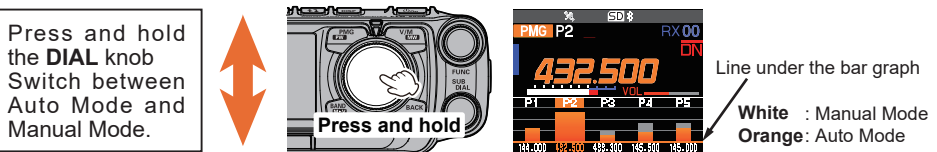

Auto Mode

- While in Dual Receive, the new signal frequency blinks on the Bar Graph. When there is no signal, receive automatically returns to the original PMG function.
- Press the blinking area of the screen during Dual Receive, Dual Receive will be canceled and the original PMG function will be restored.

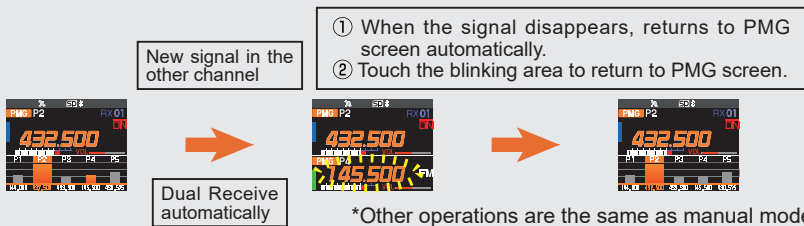

i Channels for which Dual Receive is canceled by touching the screen will not automatically become Dual Receive until the signal is lost and a new signal is received. In addition, changes in signal strength due to movement may be interpreted as new signals, and canceled signals may be immediately received again at the same time. In this case, press and hold the **DIAL** knob to switch to Manual Mode.

CFL (Customized Function List)

Easily operate frequently used functions by calling them from the function list with one-touch operation of the **FUNC** knob. You can view the list of registered priority functions and the setting status at a glance, and you can execute the function or change the setting just by selecting and pressing with the **FUNC** knob.

The following functions are registered in the function list by factory default, but you can register up to 8 frequently used functions from 127 setup menu types (see page 66) and customize the list to suit your usage.

Displays the frequency or memory channel number input screen.

The function works for the items displayed in orange.

Grayed out items are currently unavailable.

KEYPAD	HOME CH
SCAN	TXPWR HIGH
SQL OFF	ARS AUTO
RPT-R	TONE 100.0
DTMF	APRS OFF

Recall HOME channel

Change the settings for items displayed in white.

Displays the current setting value

Function List display example (factory default setting)

1 FREQUENCY INPUT (FIXED)	19 HOME CH (FIXED)
52 SCAN	8 TX POWER
45 SQL TYPE	25 RPT ARS
28 RPT REVERSE	46 TONE SQL FRQ / DCS CODE
43 DTMF	76 APRS MODEM

NOTE: The “KEYPAD” and “HOME CH” displayed at the top of the screen cannot be changed.

Use the Function List

1. Press the **FUNC** knob.
2. Touch the desired function.
Or rotate the **FUNC** knob to select the desired function, and then press the **FUNC** knob.

● Close the Function List

1. To return to the normal operation screen, press the  key or **PTT** switch.

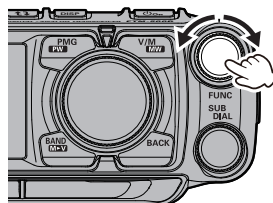

KEYPAD	HOME CH
SCAN	TXPWR HIGH
SQL OFF	ARS AUTO
RPT-R	TONE 100.0
DTMF	APRS OFF

Registration to the Function List

1. Press and hold the **FUNC** knob.
The Setup Menu screen is displayed.
2. Rotate the **FUNC** knob to select the item to be registered in the Function List.

DISPLAY	
1	FREQUENCY INPUT >
2	LCD BRIGHTNESS
3	FREQUENCY COLOR
4	BAND SCOPE
MAX	

3. Press and hold the **FUNC** knob.
The Function List screen appears, and the selected function name flashes.
NOTE: The “KEYPAD” and “HOME CH” displayed at the top of the screen cannot be changed.

KEYPAD	HOME CH
BRIGHTNESS	TXPWR HIGH
SQL OFF	ARS AUTO
RPT-R	TONE 100.0
DTMF	APRS OFF
Write to FUNCTION MENU	

4. Rotate the **FUNC** knob to select the location to register.

KEYPAD	HOME CH
SCAN	TXPWR HIGH
SQL OFF	ARS AUTO
RPT-R	TONE 100.0
BRIGHTNESS	APRS OFF
Write to FUNCTION MENU	

5. Press the **FUNC** knob.
 - The function is registered in the selected location and the Function List is changed.
 - If a location that has already been registered is selected, that item will be overwritten.

KEYPAD	HOME CH
SCAN	TXPWR HIGH
SQL OFF	ARS AUTO
RPT-R	TONE 100.0
BRIGHTNESS	APRS OFF
>	

Cancel registration in the Function List

1. Press the **FUNC** knob.
The Function List screen is displayed.
2. Rotate the **FUNC** knob to select the registered item to cancel.
NOTE: The “KEYPAD” and “HOME CH” displayed at the top of the screen cannot be changed.

KEYPAD	HOME CH
SCAN	TXPWR HIGH
SQL OFF	ARS AUTO
RPT-R	TONE 100.0
BRIGHTNESS	APRS OFF
MAX	

3. Press and hold the  key.
The confirmation screen will be displayed.
4. Rotate the **FUNC** knob to select [OK] and press the **FUNC** knob.
The item will be deleted and the list item will be blank.

KEYPAD	HOME CH
SCAN	TXPWR HIGH
SQL OFF	ARS AUTO
RPT-R	TONE 100.0
BRIGHTNESS	APRS OFF
MAX	

AESS (Acoustic Enhanced Speaker System)

The phase adaptation speaker system AESS (Acoustic Enhancement Speaker System) is generated conjointly by the main-unit speaker and the front speaker. By varying the phase, output balance, and frequency characteristics of the front and main speaker output, AESS achieves clear, high-fidelity audio that reduces fatigue even when used for sustained communications.

1. Press and hold the **VOL/SQL (MAIN)** knob.
Or press and hold the **FUNC** knob → select [18 AUDIO EQUALIZER].

2. Press the **FUNC** knob.

3. Rotate the **FUNC** knob to set the sound quality of the front speaker.

OFF :Standard sound quality without AESS

FLAT :Use AESS without changing sound quality

HI PITCH :Emphasizes high frequencies

LO PITCH :Emphasizes low frequencies

BPF :Attenuates high and low frequencies

4. Press the **FUNC** knob.

5. Similarly, rotate the **FUNC** knob to select each item of “REAR TONE”, “REAR OUT” and “AESS PHASE”, then press the **FUNC** knob.

6. Rotate the **FUNC** knob and refer to the table below to select settings.

7. Press the **DIAL** knob, **SUB DIAL** knob or **PTT** switch to save the settings and return to normal operation.

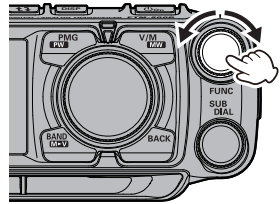
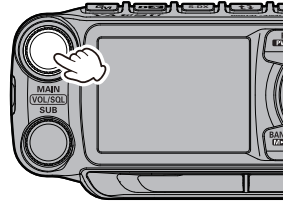

FRONT TONE

OFF	Standard sound quality without AESS (When set to OFF, only “REAR OUT” cannot be set.)
FLAT	Use AESS without changing sound quality
HI PITCH	Emphasizes high frequencies
LO PITCH	Emphasizes low frequencies
BPF	Attenuates high and low frequencies

REAR TONE

FLAT	Use AESS without changing sound quality
HI PITCH	Emphasizes high frequencies
LO PITCH	Emphasizes low frequencies
BPF	Attenuates high and low frequencies
1kHz	Cuts high frequencies above 1kHz
700Hz	Cuts high frequencies above 700Hz

REAR OUT

0% - 100%	Output level of the main body speaker
------------------	---------------------------------------

AESS PHASE

OFF	Use AESS without changing the time delay
1.25ms - 20.00ms	Sets the time delay between the audio output of the control head speaker and the main unit speaker.

Name and function of each component

Control Head (front)

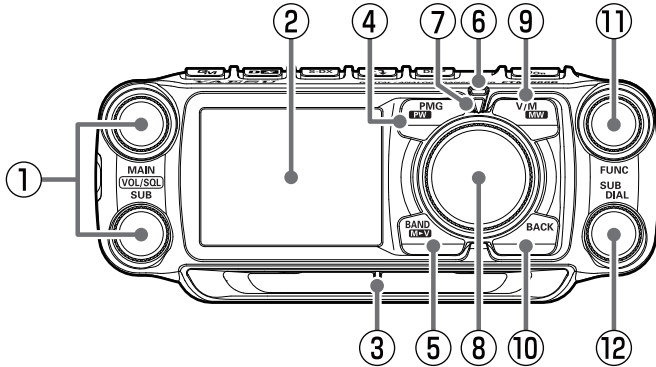

① VOL/SQL knob

Rotate the **VOL/SQL** Knob to adjust the audio volume level.

VOL/SQL knob (Upper): Main-Band
VOL/SQL knob (Lower): Sub-Band

Press the **VOL/SQL** knob, then rotate the **FUNC** knob to adjust the squelch level. The squelch level may be adjusted to mute the background noise when no signal is present.

② Full color screen display

③ Speaker

The 6W high output front speaker at the bottom of the control-head, ensures clear and powerful audio.

④ key

• Press:

Displays PMG (Primary Memory Group). (see page 14)

Press and hold the **DIAL** knob to switch between auto mode and manual mode.

In manual mode, use the **DIAL** knob to select the receive frequency.

Press and hold the **DIAL** knob to switch to auto mode, when a designated frequency is received, the signal is automatically selected and the received audio is heard.

Press again to cancel PMG mode.

• Press and hold:

Register the displayed frequency in PMG.

Press and hold in VFO mode or memory mode to register the current frequency in PMG.

Up to 5 channels can be registered for PMG regardless of the frequency band.

⑤ key

VFO mode

• Press:

Each key press switches the operating frequency band.

Band	Selectable Frequency Range
AIR	108MHz - 137MHz
144MHz	137MHz - 174MHz
VHF	174MHz - 400MHz
430MHz	400MHz - 480MHz
UHF	480MHz - 999.995MHz

• Press and hold:

Set the band that can be selected by pressing this key.

Memory mode

• Press:

Each time the key is pressed, only memory channels of the same frequency band are automatically recalled as a group as shown below.

M-ALL (All memory channels)

M-AIR (AIR band memory channels)

M-VHF (144MHz band memory channel)

M-UHF (430MHz band memory channel)

OTHER (174MHz - 400MHz and 480MHz - 999.995MHz band memory channels)

Bands that have not been stored are not displayed.

• Press and hold:

Transfers the contents of the recalled memory channel to the VFO and enters VFO mode.

⑥ Super DX indicator

Lights white when the Super DX function is in operation.

⑦ Mode indicator

The current operating mode is indicated by the color of the LED.

Blue	VFO mode
Green	When memory M-ALL is recalled.
Red	When memory M-AIR, M-VHF, M-UHF or OTHER is recalled.
Orange	PMG function

⑧ DIAL knob

Change the frequency or select the memory channel of the Main-Band.

- In VFO mode, the frequency may be changed in 1MHz increments after pressing the knob.
- In Memory Mode, press and then turn the knob to select in 10 channel steps.

⑨ key

- **Press:**
Each key press switches between VFO mode and memory mode.
When a memory channel is recalled, the memory channel number is displayed, such as "M-ALL 001". The last operated memory channel is recalled.
- **Press and hold:**
Press and hold the key to display the memory channel list screen.
Writing to memory or recalling and editing of stored memory channel.

⑩ key

Press the this key to return to the previous screen.

⑪ FUNC knob

- **Press:**
Display the CFL (Customized Function List) screen. Rotate the **FUNC** knob to select an item and perform the functions and make settings.
- **Press and hold:**
To enter set-up menu. The Set Mode permits configuring the various functions according to individual operating needs and preferences. (Refer to page 66).

⑫ SUB DIAL

Change the frequency or select the memory channel of the Sub-Band.

- In VFO mode, the frequency may be changed in 1MHz increments after pressing the knob.
- In Memory Mode, press and then turn the knob to select in 10 channel steps.
- On the Setup Menu screen, rotate the knob to scroll through the 17 categories in the Setup Menu (See below):

DISPLAY ↔ TX ↔ RX ↔ MEMORY ↔
↔ CONFIG ↔ AUDIO ↔ SIGNALING ↔
↔ SCAN ↔ DIGITAL ↔ GM ↔ WIRES-X ↔
↔ DATA ↔ APRS ↔ SD CARD ↔ OPTION ↔
↔ CLONE ↔ RESET

Control Head (top)

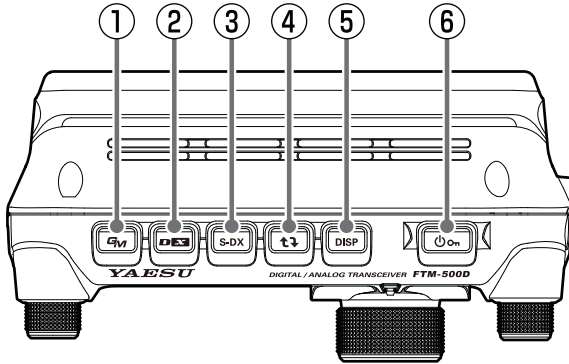

① **GM** key

- **Press:**

Turn the GM (group monitor) function ON/OFF.
(For details on the function, refer to the GM Function Instruction Manual which may be downloaded from the Yaesu website.)

- **Press and hold:**

Enter DG-ID number setting screen.

1. Rotate the **FUNC** knob to select **[DG-ID TX]** (Transmit DG-ID number), and then press the **FUNC** knob.
2. Rotate the **FUNC** knob to select the DG-ID number from 00 to 99, and then press the **FUNC** knob.
3. Similarly, set **[DG-ID RX]** (receive DG-ID number).
 - While setting the DG-ID number, pressing and holding the **FUNC** knob will set the transmit and the receive DG-ID numbers to "00".

② **DES** key

- **Press:**

Each time this key is pressed for a short time the communication mode changes:

AMS (/) → DN → FM → AMS ...

Normally, the communication mode is automatically set to the mode of the partner station, by setting to "AMS" (AMS display example: /) , which can receive the signal of the partner station.

- **Press and hold:**

To start the WIRES-X.

The WIRES-X enables long-distance communication in digital communication systems via the Internet. (For details on this function, refer to the WIRES-X Function Instruction Manual which may be downloaded from the Yaesu website.)

Press and hold this key again to return to the normal operation screen.

③ **S-DX** key

Enable the Super DX function to increase sensitivity.

④ **t↕** key

- **Press:**

Select the operation band.

Each press key between Main-band (frequency at the top of the screen) and Sub-band (frequency at the bottom of the screen).

- **Press and hold:**

Copies the Main-Band frequency (at the top of the screen), to the Sub-Band frequency (at the bottom of the screen).

⑤ **DISP** key

Press the key to display the scope screen with the current frequency or memory channel as the center and the status of the upper and lower channels (received signal strength) in a graph.
Press the key again to return to the normal screen.

⑥ **Power On/Off** Switch

Press and hold this key to switch the power ON or OFF.

When the power is ON, press this button briefly to engage, or release the key lock.

Control Head (Left and right side)

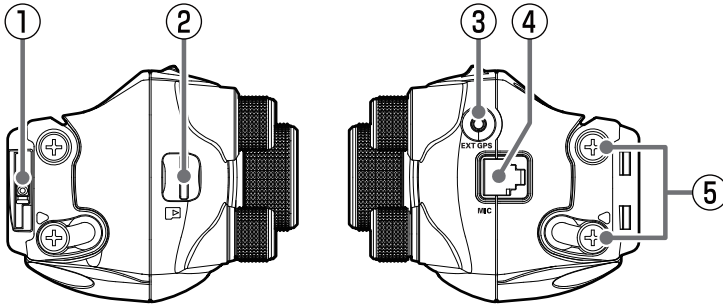

① **Release knob**

Press to release the control panel from the transceiver.

② **micro-SD card slot**

Insert a commercially available micro SD card to backup the various radio settings, memory channels, recordings of received audio, and recordings of snapshot images, etc.

③ **EXT GPS jack**

Plug in a cable to connect with external GPS devices. The communication baud rate is fixed at 9600bps.

④ **MIC jack**

⑤ **Control Head angle adjusting Screw**

Loosen these screws to change the angle of the control head.

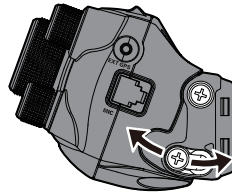

Control Head (rear)

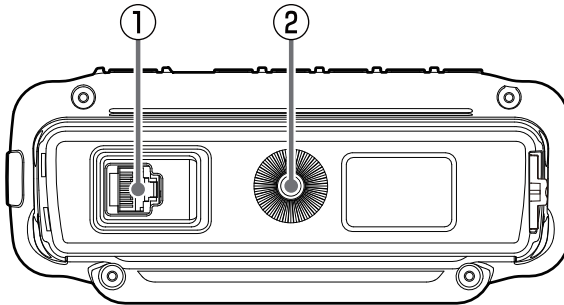

① **CONTROL jack**

Plug in the control cable into this jack to connect with the main body.

② **Screw hole for bracket**

Attach the optional control head bracket.

Main body (Front)

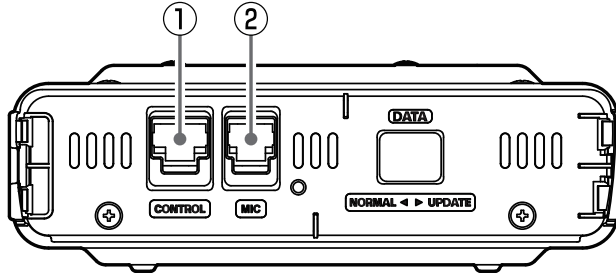

① CONTROL jack

Plug the control cable into this jack to connect with the control panel.

② MIC jack

Connect the cable of the included DTMF microphone SSM-85D or the optional microphone MH-42C6J.

Main body (rear)

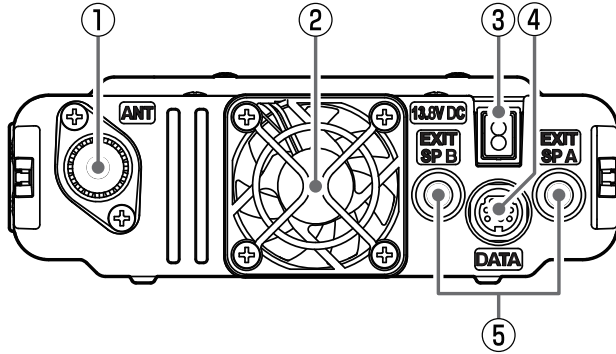

① ANT terminal

Connect the co-axial cable for the antenna.

② Cooling fan

③ 13.8V DC

Connect the provided DC power supply cable (with fuse attached).

④ DATA Jack

Connect a cable for remote operation, or the cable to connect with the PC interface unit and the external terminal unit.

⑤ EXT SP A jack / EXT SP B jack

For the operation when external speakers are connected to each jack, see the following:

	External Speaker A	External Speaker B	Internal Speaker
Connect to A only	Main band and Sub band audio	-	-
Connect to B only	-	Sub band audio	Main band audio
Connect to both A and B	Main band audio	Sub band audio	-

The front speakers will output audio even if an external speaker is connected. To mute front speaker sound, change the setup menu [42 FRONT SP MUTE] to "AUTO MUTE".

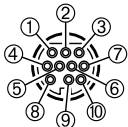

- ① PKD (packet data input)
- ② GND
- ③ PKS (PTT)
- ④ RX 9600bps (9600 bps packet data output)
- ⑤ RX 1200bps (1200 bps packet data output)
- ⑥ PK SQL (squelch control)
- ⑦ TXD (serial data output [transceiver → PC])
- ⑧ RXD (serial data input [transceiver ← PC])
- ⑨ CTS (data communication control)
- ⑩ RTS (data communication control)

Microphone (SSM-85D)

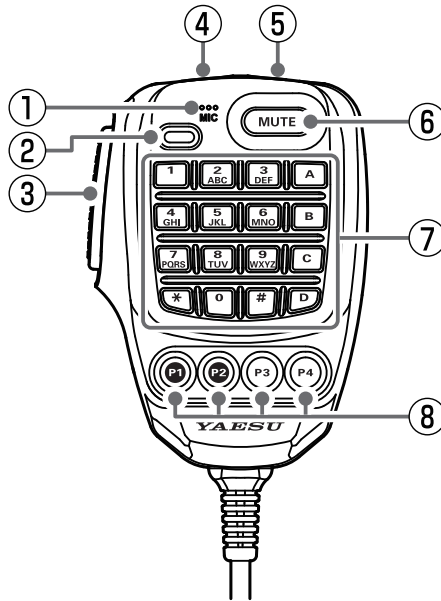

① MIC

Speak into the microphone during transmission.

② TX LED

Lights red while pressing PTT switch.

③ PTT

Press and hold the PTT switch to transmit, and release it to receive.

Press this key during the set mode to exit the set mode.

④ DWN

- Press this button to move the frequency or memory channel lower by one step, press and hold it to start scanning.
- On the memory channel list screen, press to select memory channels in 10 channel steps.
- On the Setup Menu screen, press to jump to the previous category of the Setup Menu.

⑤ UP

- Press this button to move the frequency or memory channel up by one step, press and hold it to start scanning.
- On the memory channel list screen, press to select memory channels in 10 channel steps.
- On the Setup Menu screen, press to jump to the next category of the Setup Menu.

⑥ MUTE

Press this button to mute the receive audio. Press it again to unmute the audio.

⑦ DTMF keypad

Press these keys during transmit to enter and send a DTMF sequence. The following operations can be performed during receive.

0 - 9 : Enter the frequency or memory channel number.

A : No function assigned.

B : Each press switches between Main-band and Sub-band.

C : Adjust the squelch level.

D : The band scope function operates.

* : Each press switches between VFO mode and memory mode.

: This key has the same function as the  key on the controller.

VFO mode:

Each press changes the operating frequency band.

AIR → 144MHz → VHF → 430MHz → UHF

Memory mode:

Each time the key is pressed only memory channels of the same frequency band are automatically recalled as a group, as shown below:

M-ALL → M-AIR → M-VHF →
M-UHF → OTHER →

* Bands that have not been stored are not displayed.

⑧ Program keys (P1/P2/P3/P4)

The default function settings of the [P1] / [P2] / [P3] / [P4] keys are shown in the table below.

Key	Function	Press	Press and hold
P1	2nd PTT	Transmit on the SUB Band frequency (at the bottom of the screen)	
P2	HOME	Recalls HOME channel	
P3	DX	Selects communication mode	Activates the WIRES-X feature
P4	WX (T-CALL)	WX (T-CALL: European version)	

The functions of the [P1] / [P2] / [P3] / [P4] keys can be assigned by the following operations:

1. Press and hold the **FUNC** knob.
2. Rotate the **FUNC** knob to select [**29 MIC PROGRAM KEY**], then press the **FUNC** knob.
4. Rotate the **FUNC** knob to select a key to assign a function [**P1**] / [**P2**] / [**P3**] / [**P4**] then press the **FUNC** knob.
5. Rotate the **FUNC** knob to select a function (see the table below) then press the **FUNC** knob.

Function	Description
OFF	(disable the P key)
2nd PTT	Transmit on the SUB Band frequency (at the bottom of the screen)
GM	Press to GM Function Press and hold to DG-ID setting screen
REC/STOP	Voice recording function "REC" / "STOP"
SCAN	Starts or stops the scanning function
HOME CH	Recalls the HOME channel
RPT SHIFT	Sets the repeater shift direction
REVERSE	Reverses the transmit and receive frequencies in repeater mode or split memory.
TX POWER	Selects the transmit power output level
SQL OFF	Opens the squelch (SQL off)
T-CALL	Transmits the T-CALL(1750 Hz)
VOICE	Announces the current frequency (requires optional FVS-2)
D_X	Press to select communication mode Press and hold to activate the WIRES-X feature
WX	Switches operation to the Weather Channel Bank
STN LIST	Displays the APRS function station list
MSG LIST	Displays the message list of the APRS function
REPLY	Enters the APRS function reply message write mode
MSG EDIT	Enters the APRS function message write mode
DW	Operation setting of dual receive function

Display

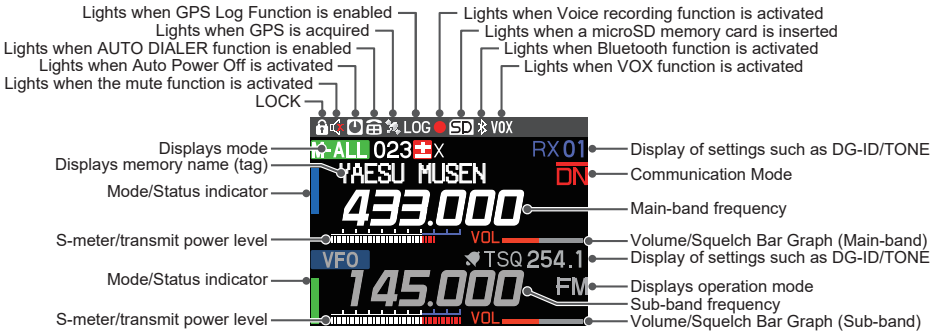

● Status Bar



Appears when the lock function is enabled.



Appears when the Mute function for Sub-band is enabled.



Appears when the APO (Automatic Power-Off) function is enabled.



Appears when the DTMF Autodialer function is activated.



Appears when the GPS Satellites are acquired.



Appears when the GPS Log function is enabled.



Appears when the Voice recording function is activated. (About 3 seconds after the squelch closes, the recording pauses and a "II" appears.)



Appears when a microSD card is inserted.



Appears when the Bluetooth function is activated.
 Appears: Bluetooth device is connected.
 Blinks: Bluetooth device not connected.



Appears when the VOX function is enabled.

● Main-Band / Sub-Band display area

Displays mode (VFO Mode and Memory Mode are switched each time the Mode area is touched.)

M-ALL

Memory channels of the same frequency band are automatically grouped and recalled as follows by the memory auto grouping (MAG) function.

M-AIR

M-ALL : Recalls all memory channels regardless of frequency band

M-VHF

M-AIR : Recalls only memory channels in the AIR band (108 - 137MHz).

M-UHF

M-VHF : Recalls only memory channels in the 144MHz band (137 - 174MHz).

OTHER

M-UHF : Recalls only memory channels in the 430MHz band (400 - 480MHz).

OTHER : Recalls only VHF and UHF memory channels (174 - 400MHz and 480 - 999.995MHz).

PMG

PMG (Primary Memory Group) Function

VFO

VFO mode

HOME

HOME Channel



: Repeater minus (-) shift



: Repeater plus (+) shift



: Split operation



Skip Memory Channel

(Permits designating undesired channels to be skipped during scanning.)



Bell function is activated.

TX00

TX/RX DG-ID is displayed

RX00

TX00 : TX DG-ID is displayed

RX00 : RX DG-ID is displayed



Mode/Status indicator

Red : Transmitting

Blue : Receiving (Digital C4FM mode)

Green : Receiving (Analog FM mode)

White : Receiving (Analog AM mode)

Squelch type is displayed (For additional details, refer to the Advanced Manual.)

TN

TN : Tone Encoder (tone frequency is displayed)

TSQ

TSQ : Tone Squelch (tone frequency is displayed)

RTN

RTN : Reverse Tone (tone frequency is displayed)

DCS

DCS : DCS (Digital Code Squelch) (DCS code is displayed)

PR

PR : No-communication Squelch

PAG

PAG : Pager (EPCS)

DC

The following can be set when the squelch expansion (see page 69) is "ON":
DC : Send the DCS code only during transmission. (DCS code is displayed)

T-D

T-D : Send the CTCSS tone signal during transmit, and wait for the DCS code in receive mode. (tone frequency is displayed)

D-T

D-T : Send the DCS code during transmit, and wait for the CTCSS tone signal in receive mode. (tone frequency is displayed)

Communication Mode (The Operating Mode switches each time the Mode area is touched.)

Displays the operating mode (Digital modes are indicated by a red icon)

FM : FM (Analog) mode

AM : AM (Analog) mode

DN : V/D mode (Simultaneous voice and data communication mode)

VW : Voice FR mode (Voice full-rate mode)

DW : Data FR mode (High speed data communication mode)



FM : AMS (Automatic Mode Select) FM (Analog) mode

DN : AMS (Automatic Mode Select) DN mode

VW : AMS (Automatic Mode Select) VW mode

DW : AMS (Automatic Mode Select) DW mode

*When AMS (Automatic Mode Select) function is activated, the indicator is shown with a bar appearing above the mode. The transceiver automatically switches to the DW mode during image transmission.

 : S meter (Displays received signal strength in 10 levels)

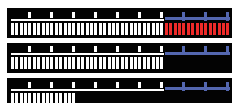
 : PO meter (Displays transmit output in 3 levels when transmitting)

VOL  : Volume level

SQL  : SQL level

Descriptions of Main Screens

● Normal screen (VFO screen)

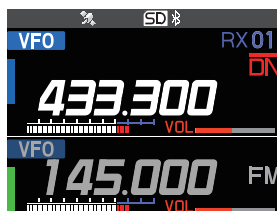

Main-band and Sub-band are displayed in a top-down fashion.

Both bands are received simultaneously.

*C4FM digital signal standby is available in both Main-band and Sub-band.

● PMG screen

Press the  key to display the PMG (Primary Memory Group) screen.

The PMG function, which displays the receive status of the registered channels in a bar graph, can register up to 5 channels by simply pressing and holding the  key for the current display frequency, either of the VFO or the memory channel.

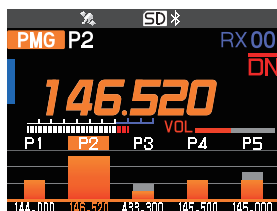

- The PMG screen auto mode and manual mode can be switched by press and hold the **DIAL** knob.
- Touch the bar graph to automatically Dual receive.
- Touch and hold the bar graph to switch the operating channel.

● Band Scope screen

Press the **DISP** key to display the Band Scope screen.

The strengths of received signals above and below the current frequency or memory channel are shown in a graph while sweeping at high speed. The audio of the center frequency is heard without interruption.

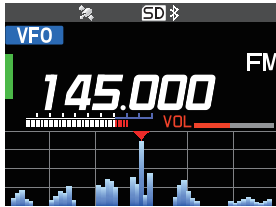

- Rotate the **DIAL** knob to change the frequency or memory channel.
- In VFO mode 61 or 31 channels can be searched. In memory mode 21 or 11 channels can be searched by the Band Scope (See “Change the number of channels displayed during scope operation” (page 12))

● Function List screen

Press the **FUNC** knob to display the “Function List” screen that displays only the registered items from the Setup Menu (see page 66). To return to the normal operation screen from the Function List, press the **BACK** key or **PTT** switch.

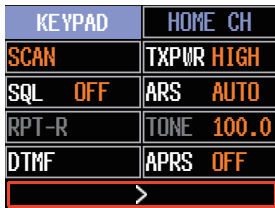

By default, the following 10 setup items are registered in the Function List. Setup Menu items can be registered, canceled, or canceled at any time.

1 FREQUENCY INPUT (FIXED)	19 HOME CH (FIXED)
52 SCAN	8 TX POWER
45 SQL TYPE	25 RPT ARS
28 RPT REVERSE	46 TONE SQL FRQ / DCS CODE
43 DTMF	76 APRS MODEM

NOTE: The KEYPAD and HOME CH cannot be changed or unregistered.

● Setup Menu screen

Press and hold the **FUNC** knob to display the Setup Menu screen. The Setup Menu allows selecting various functions from the displayed list and then setting the parameters of each function according individual preferences.

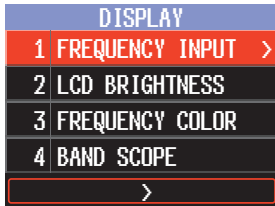

Press the **DIAL** knob, **SUB DIAL** knob or **PTT** switch to save the settings and return to normal operation.

● Compass screen

Touch the screen while receiving a C4FM signal containing location information, the distance and direction of the other station will be displayed on the compass screen.

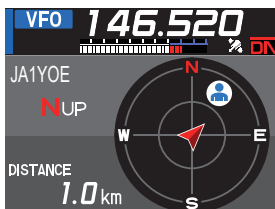

- : Direction of the other station
- : Heading direction of this station
- Touch the compass display to return to the previous screen.

- **BACKTRACK screen**

Press and hold the **FUNC** knob → [7 **DISPLAY MODE**] → [**BACKTRACK**]

- **Real-time navigation function**

Displays the position and direction of the other station in real time during communication in C4FM digital V/D mode (The signal of the other station must contain GPS location information). It is also possible to switch the display to show the traveling direction of your own station and the distance to the destination.

- **BACKTRACK function**

Register up to three locations (“★”, “L1”, “L2”), such as the departure point or the current location of the other station, then display and navigate in real time the distance and direction of the registered location as viewed from the current location.

- **Altitude screen**

Press and hold the **FUNC** knob → [7 **DISPLAY MODE**] → [**ALTITUDE**]

The altitude versus the moving distance is displayed in a graph using the GPS signal.

- **TIMER/CLOCK screen**

Press and hold the **FUNC** knob → [7 **DISPLAY MODE**] → [**TIMER/CLOCK**]

CLOCK, LAP timer and Countdown timer functions are available.

- **GPS Information screen**

Press and hold the **FUNC** knob → [7 **DISPLAY MODE**] → [**GPS INFORMATION**]

Displays the status of signals received from GPS satellites and related information.

About this manual

The following notation is also used in this manual.



This icon indicates cautions and information that should be read.



This icon indicates notes, tips and information that should be read.

PLEASE NOTE: Due to product improvements, some of the illustrations in the instruction manual may differ from the actual product.

Safety Precautions (Be Sure to Read)

Be sure to read these important precautions, and use this product safely.

Yaesu is not liable for any failures or problems caused by the use or misuse of this product by the purchaser or any third party. Also, Yaesu is not liable for damages caused through the use of this product by the purchaser or any third party, except in cases where ordered to pay damages under the laws.

Types and meanings of the marks



DANGER

This mark indicates an imminently hazardous situation, which, if not avoided, could result in death or serious injury.



WARNING

This mark indicates a potentially hazardous situation, which, if not avoided, could result in death or serious injury.



CAUTION

This mark indicates a potentially hazardous situation, which, if not avoided, may result in minor or moderate injury or only property damage.

Types and meanings of symbols



These symbols signify prohibited actions, which must not be done to use this product safely. For example:  indicates that the product should not be disassembled.



These symbols signify required actions, which must be done to use this product safely. For example:  indicates that the power plug should be disconnected.



DANGER



Do not use the device in "regions or aircrafts and vehicles where its use is prohibited" such as in hospitals and airplanes.
This may exert an impact on electronic and medical devices.



Do not use this product while driving or riding a motorbike. This may result in accidents.
Make sure to stop the car in a safe location first before use if the device is going to be used by the driver.



Do not operate the device when flammable gas is generated.
Doing so may result in fire and explosion.



Never touch the antenna during transmission.
This may result in injury, electric shock and equipment failure.



Do not transmit in crowded places in consideration of people who are fitted with medical devices such as heart pacemakers.
Electromagnetic waves from the device may affect the medical device, resulting in accidents caused by malfunctions.



When an alarm goes off with the external antenna connected, cut off the power supply to this radio immediately and disconnect the external antenna from this radio.
If not, this may result in fire, electric shock and equipment failure.



Do not touch any liquid leaking from the liquid display with your bare hands.
There is a risk of chemical burns occurring when the liquid comes into contact with the skin or gets into the eyes. In this case, seek medical treatment immediately.



WARNING



Do not use voltages other than the specified power supply voltage.
Doing so may result in fire and electric shock.



Do not transmit continuously for long periods of time.
This may cause the temperature of the main body to rise and result in burns and failures due to overheating.



Do not dismantle or modify the device.
This may result in injury, electric shock and equipment failure.



Do not handle the power plug and connector etc. with wet hands. Also do not plug and unplug the power plug with wet hands.
This may result in injury, liquid leak, electric shock and equipment failure.











When smoke or strange odors are emitted from the radio, turn off the power and disconnect the power cord from the socket.
This may result in fire, liquid leak, overheating, damage, ignition and equipment failure. Please contact our company amateur customer support or the retail store where you purchased the device.









Keep the power plug pins and the surrounding areas clean at all times.
This may result in fire, liquid leak, overheating, breakage, ignition etc.





















Disconnect the power cord and connection cables before incorporating items sold separately and replacing the fuse.
This may result in fire, electric shock and equipment failure.

-  **Never cut off the fuse holder of the DC power cord.**
This may cause short-circuiting and result in ignition and fire.
-  **Do not use fuses other than those specified.**
Doing so may result in fire and equipment failure.
-  **Do not allow metallic objects such as wires and water to get inside the product.**
This may result in fire, electric shock and equipment failure.
-  **Do not place the device in areas that may get wet easily (e.g. near a humidifier).**
This may result in fire, electric shock and equipment failure.
-  **When connecting a DC power cord, pay due care not to mix up the positive and negative polarities.**
This may result in fire, electric shock and equipment failure.
-  **Do not use DC power cords other than the one enclosed or specified.**
This may result in fire, electric shock and equipment failure.
-  **Do not bend, twist, pull, heat and modify the power cord and connection cables in an unreasonable manner.**
This may cut or damage the cables and result in fire, electric shock and equipment failure.
-  **Do not pull the cable when plugging and unplugging the power cord and connection cables.**
Please hold the plug or connector when unplugging. If not, this may result in fire, electric shock and equipment failure.

-  When transmitting, keep the antenna at least 1.8m (VHF) or 2.2m (UHF) away from your body. Do not use modified or damaged antennas.
-  **RF Exposure:** This device should be operated with a minimum separation distance of 20cm (8 inches) between the equipment and a person's body.
-  **Refrain from using headphones and earphones at a loud volume.**
Continuous exposure to loud volumes may result in hearing impairment.
-  **Do not use the device when the power cord and connection cables are damaged, and when the DC power connector cannot be plugged in tightly.**
Please contact our company amateur customer support or the retail store where you purchased the device as this may result in fire, electric shock and equipment failure.
-  **Follow the instructions given when installing items sold separately and replacing the fuse.**
This may result in fire, electric shock and equipment failure.
-  **Do not use the device when the alarm goes off.**
For safety reasons, please pull the power plug of the DC power equipment connected to the product out of the AC socket.
-  Never touch the antenna as well. This may result in fire, electric shock and equipment failure due to thunder.

CAUTION

-  **Do not place this device near a heating instrument or in a location exposed to direct sunlight.**
This may result in deformation and discoloration.
-  **Do not place this device in a location where there is a lot of dust and humidity.**
Doing so may result in fire and equipment failure.
-  **Stay as far away from the antenna as possible during transmission.**
Long-term exposure to electromagnetic radiation may have a negative effect on the human body.
-  **Do not wipe the case using thinner and benzene etc.**
Please use a soft and dry piece of cloth to wipe away the stains on the case.
-  **Keep out of the reach of small children.**
If not, this may result in injuries to children.
-  **Do not put heavy objects on top of the power cord and connection cables.**
This may damage the power cord and connection cables, resulting in fire and electric shock.
-  **Do not transmit near the television and radio.**
This may result in electromagnetic interference.
-  **Do not use optional products other than those specified by our company.**
If not, this may result in equipment failure.
-  **When using the device in a hybrid car or fuel-saving car, make sure to check with the car manufacturer before using.**
The device may not be able to receive transmissions normally due to the influence of noises from the electrical devices (inverters etc.) fitted in the car.
-  **For safety reasons, switch off the power and pull out the DC power cord connected to the DC power connector when the device is not going to be used for a long period of time.**
If not, this may result in fire and overheating.
-  **Do not throw or subject the device to strong impact forces.**
This may result in equipment failure.
-  **Do not put this device near magnetic cards and video tapes.**
The data in the cash card and video tape etc. may be erased.
-  **Do not turn on the volume too high when using a headphone or earphone.**
This may result in hearing impairment.
-  **Do not place the device on an unsteady or sloping surface, or in a location where there is a lot of vibration.**
The device may fall over or drop, resulting in fire, injury and equipment failure.
-  **Do not stand on top of the product, and do not place heavy objects on top or insert objects inside it.**
If not, this may result in equipment failure.
-  **Do not use a microphone other than those specified when connecting a microphone to the device.**
If not, this may result in equipment failure.
-  **Do not touch the heat radiating parts.**
When used for a long period of time, the temperature of the heat radiating parts will get higher, resulting in burns when touched.
-  **Do not open the case of the product except when replacing the fuse and when installing items sold separately.**
This may result in injury, electric shock and equipment failure.

About the antenna

The antenna is an extremely important part for both transmitting and receiving. The antenna type and its inherent characteristics determine whether the performance of the transceiver can be fully realized. As such, please note the following:

- Use an antenna that is suitable for the installation conditions and application objective.
- Use an antenna that is suitable for the operating frequency band.
- Use an antenna and a coaxial cable with a characteristic feed point impedance of 50Ω .
- Adjust the VSWR (Voltage Standing Wave Ratio) until it is 1.5 or less for an antenna with an adjusted impedance of 50Ω .
- Keep the coaxial cable routing length as short as possible.

Connection of Antenna and Power Cables

Please follow the outline in the illustration regarding the proper connection of antenna coaxial cables and Power Supply.

Cautions

- Do not use a DC power supply cable other than the one that is provided.
- Do not use the DC power supply cable with the fuse holder cut off.
- Use an external power source capable of supplying DC 13.8 V, a current capacity of 15 A or more.

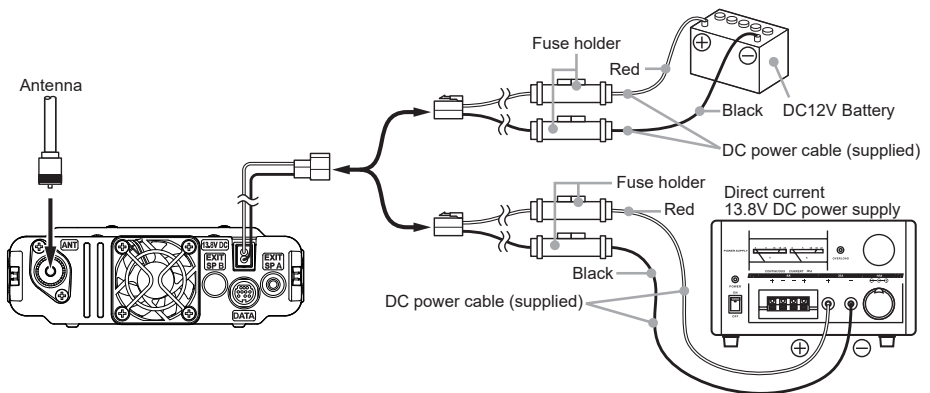

Installing the Transceiver/Microphone

The control head and main body are connected with a control cable.

When needed, use the optional Control Cable 20ft (6m) to connect the main body to the “CONTROL” terminal of the control head.

Connect the supplied microphone SSM-85D to the “MIC” terminal of the transceiver or control head.

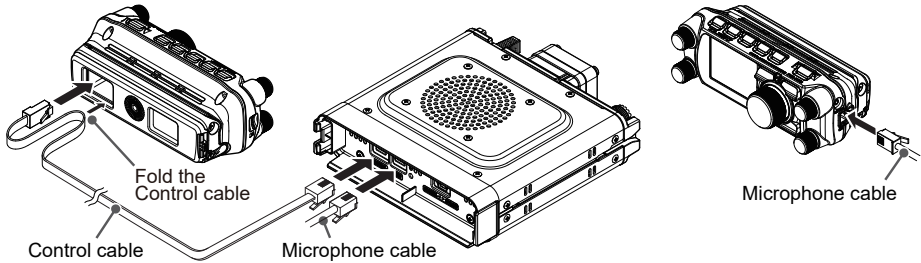

Install the main body using the supplied bracket

1. Select the installation location.

Caution : Select a location where the transceiver can be securely attached.

2. Drill four 6mm diameter holes in the location where the bracket is to be mounted, matching the positions of the bolting holes of the bracket.

The bracket can be mounted on either the top or bottom side of the radio body.

3. Insert the grooves on both sides of the main body into the bracket until they click and lock. Tighten the screw against the lever to lock the transceiver in the bracket.
4. To remove the main body from the bracket, loosen the locking screw, and then pull the transceiver out while pressing the lever indicated by the arrow below.

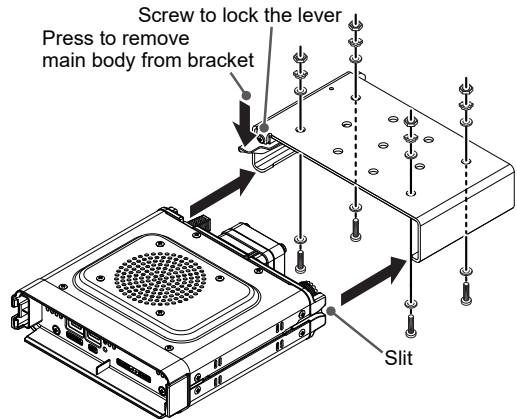

● Using the optional Dash Mount Bracket “MMB-103”

- Screw, sheet and double-sided tape are included with the bracket.
- The bracket can be formed by hand to match the location where the front panel is installed.

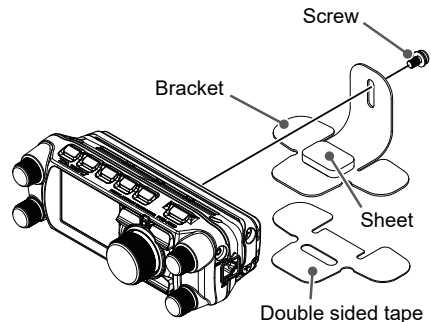

Using the optional Swing Head Kit “SJKM-500”

The optional control head extension cable “CT-132” is not required.

Freely change the angle of the control head up, down, left, or right.

● Remove the control head from the transceiver body

To install the SJKM-500 Swing Head Kit, remove the control head from the transceiver body.

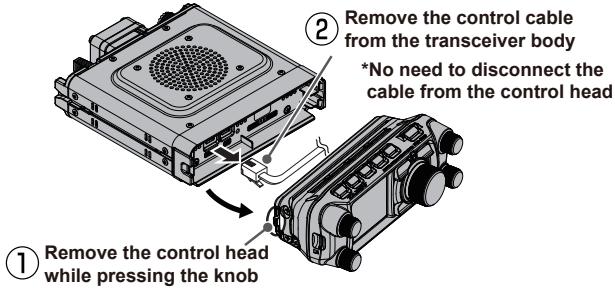

● Attach the SJKM-500 to the control head

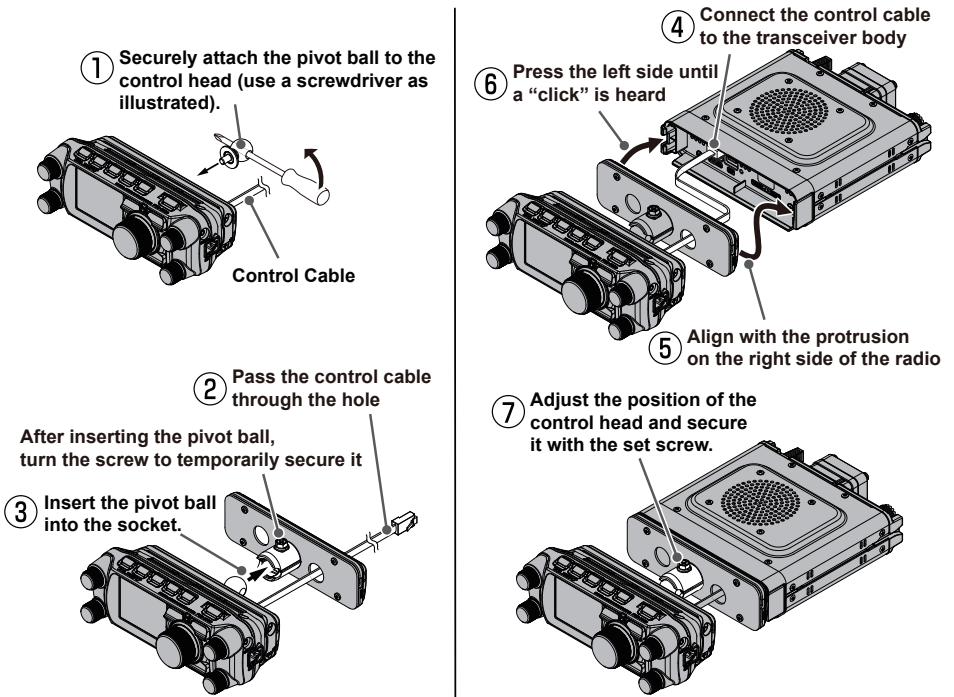

Using a Micro SD Memory Card

Using a microSD memory card with the transceiver allows the following functions.

- Backing up the transceiver data and information
- Saving memory information
- Voice recording and playback
- Saving messages downloaded with the GM function or WIRES-X function
- Saving GPS log data

Usable microSD Memory Cards

This transceiver only supports the following capacity of microSD and microSDHC memory cards.

• 2GB • 4GB • 8GB • 16GB • 32GB



- microSD memory cards formatted on other devices may not properly save information when used with this transceiver. Format microSD memory cards again with this transceiver when using memory cards formatted with another device.
- Do not remove the microSD memory card or turn the transceiver Off, while saving data to a microSD memory card is in progress.

Mounting and Dismounting microSD Memory Card

1. Turn the transceiver **OFF**.
2. Insert a microSD memory card into the slot on the left side of the control head.
With the terminal surface of the microSD card facing the back of the control head, push it in gently until it clicks.
3. Turn the transceiver **ON**.
When the memory card is properly detected, “” lights on the display.

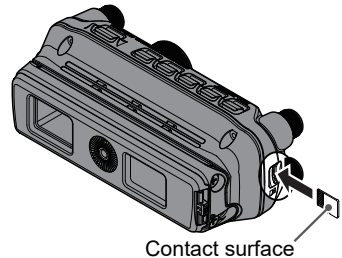

● Removing the microSD memory card

To remove the microSD memory card (inserted in step 2 above), push the memory card in until a clicking sound is heard, then remove the memory card.

Formatting a Micro SD Memory Card

Format a new microSD memory card following the steps below before use:





- A microSD memory card that was used in another device may not function properly, for example, it may not be recognized by the FTM-500DR/DE, or reading and writing may take an unusually long time. Use of the SD Memory Card Formatter provided by the SD Association may improve this. The SD Memory Card Formatter can be downloaded from this URL (<https://www.sdcard.org/downloads/formatter/index.html>).
- Formatting a microSD memory card erases all data saved on it. Before formatting the card, be sure to check for data and save it before formatting.

1. Press and hold the **FUNC** knob.
2. Touch [**109 FORMAT**].
Or rotate the **FUNC** knob to select [**109 FORMAT**], then press the **FUNC** knob.
“FORMAT?” appears on the LCD.
3. Rotate the **FUNC** knob to select [**OK**], then press the **FUNC** knob.
Initialization starts and “**Formatting...**” appears.
4. When formatting is completed, a beep sounds and “**Completed**” appears on the LCD.

Selecting the Communication Mode

● Using AMS (Automatic Mode Select) function

The FTM-500DR/DE transceiver is equipped with the AMS (Automatic Mode Select) function which automatically selects the communication mode corresponding to the received signal.

To utilize the AMS function, press the  key repeatedly or touch the mode icon to display “” or “” on the display. When a signal is received, the communication mode is automatically switched and the communication mode display changes.

*The display differs depending on the received signal.

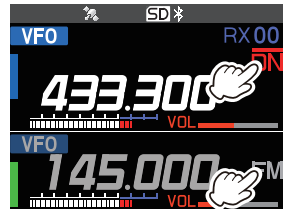
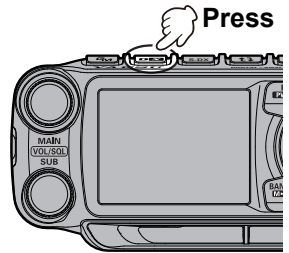

● Setting the transmit mode when using the AMS function

The AMS function will automatically set the receiver to the mode of the received signal, but the transmit mode may be fixed regardless of the received mode.

1. Press and hold the **FUNC** knob.
2. Touch [9 AMS TX MODE].
Or rotate the **FUNC** knob to select [9 AMS TX MODE], then press the **FUNC** knob.
3. Rotate the **FUNC** knob to select to the desired transmit mode as follows:
When set to “TX FM FIXED” or “TX DN FIXED” and the AMS transmission mode is fixed, the “bar” at the top of the communication mode icon flashes.

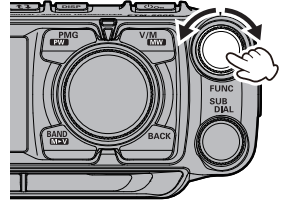

Transmit Mode	Receive and Transmit
AUTO (default)	Receive: Automatically selects the receive mode corresponding to the received signal. Transmit: Automatically transmits in the communication mode selected by the AMS function.
TX FM FIXED	Receive: Automatically selects the receive mode corresponding to the received signal. Transmit: Always transmits in the analog FM mode.
TX DN FIXED (TX DIGITAL)	Receive: Automatically selects the receive mode corresponding to the received signal. Transmit: Always transmits in the DN mode.

4. Press the **DIAL** knob, **SUB DIAL** knob or **PTT** switch to save the settings and return to normal operation.

Fixing the Communication Mode

To fix the transmit operation mode, press the **[PES]** key or touch the mode icon to select the communication mode.

When the AMS function is OFF, the “bar” above the mode icon disappears.

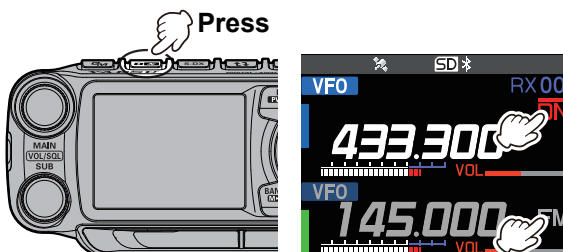

Communication Mode	Icon	Description of Modes
V/D mode (Voice & Data are transmitted simultaneously)	ON	This is the standard digital mode. Calls are less prone to interruptions caused by detection and correction of the received digital voice signal.
Voice FR mode* ¹ (Voice Full Rate Mode)	VW * ¹	High speed data communication using entire 12.5 kHz band. Enables high-quality voice communication.
FM mode	FM	Analog communication using FM mode.
AM mode (receive only)* ²	AM * ²	The AM mode is for receive only.

*1 When the Set Mode [14 DIGITAL VW] is set to “ON” (factory default is “OFF”), the Voice FR mode (VW) may be selected.

*2 When the Set Mode [16 RX MODE] is set to “AUTO” (factory default setting), AM mode is automatically selected within the AIR band.

i The transceiver automatically switches to the Data FR mode (DW) mode during image transmission.

Changing the Transmit Power Level

With the factory settings, the transmit power level changes from “HIGH” to “LOW” to “MID” when the microphone **[P4]** key is pressed (see the table below). The transmit power level can also be changed using the function List.

1. Press the **FUNC** knob.
2. Touch **[TXPWR]**.
Or rotate the **FUNC** knob to select **[TXPWR]**, then press the **FUNC** knob.
3. Rotate the **FUNC** knob to select transmit power output.
“HIGH”→“LOW”→“MID”

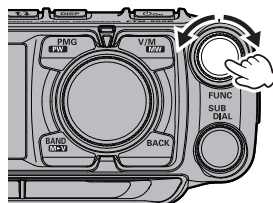

4. Press the **DIAL** knob, **SUB DIAL** knob or **PTT** switch to save the settings and return to normal operation.

Display of PO meter during transmission

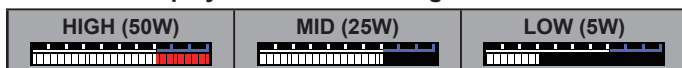

*: The factory setting is “HIGH”.

i The transmit power output can be set individually for each frequency band and memory channel in each of Main-band and Sub-band.

Setting the Skip Band

Set the band selected when the  key is pressed. By storing frequently used frequencies in the memory channel before setting the band skip, can be recall the memory that stores the frequencies of the bands that cannot be selected.

1. Press and hold the  key in VFO mode.
Or press and hold the **FUNC** knob → **[24 BAND SKIP]**
2. Rotate the **FUNC** knob to select the band to set and press the **FUNC** knob.
3. Rotate the **FUNC** knob to set “ON” (selectable) or “OFF” (not selectable).
4. Press the **DIAL** knob, **SUB DIAL** knob or **PTT** switch to save the settings and return to normal operation.

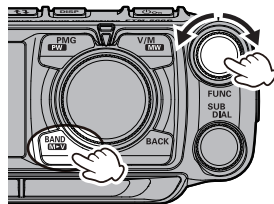

Changing the Frequency Step

The **DIAL** knob rotation frequency step may be changed. Normally, use the factory default setting of “AUTO”.

1. Press and hold the **FUNC** knob.
2. Touch **[33 STEP]**.
Or rotate the **FUNC** knob to select **[33 STEP]**, then press the **FUNC** knob.
3. Rotate the **FUNC** knob to set the frequency step.
4. Press the **DIAL** knob, **SUB DIAL** knob or **PTT** switch to save the settings and return to normal operation.

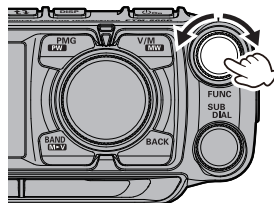

-  • The default setting, of the frequency step is set to “AUTO”, which automatically provides a suitable frequency step according to the frequency band.
- The frequency steps that can be selected depend on the frequency band.

Change the frequency display color of the operation band

The display color of the frequency of the operation band can be selected from “white”, “blue” and “red”.

1. Press and hold the **FUNC** knob.
2. Touch **[3 FREQUENCY COLOR]**.
Or rotate the **FUNC** knob to select **[3 FREQUENCY COLOR]**, then press the **FUNC** knob.
3. Rotate the **FUNC** knob to select the display color.
“WHITE” ↔ “BLUE” ↔ “RED”
4. Press the **DIAL** knob, **SUB DIAL** knob or **PTT** switch to save the settings and return to normal operation.

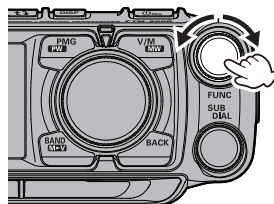

Using the convenient Digital C4FM features

About the Digital Group ID (DG-ID) feature

Digital Group ID (DG-ID) function allows using the two-digit ID numbers to communicate only with specific group members. The desired DG-ID number from 00 to 99 is set in advance by all the group members. This ID number may be set separately for transmit and receive, when the same ID number is set for both transmit and receive, only group members with the same ID number will be heard. This feature may be used to limit communication only to group members that have the same DG-ID number. The GM function may also be utilized to automatically monitor whether or not group member stations with the same DG-ID number are operating within communication range.

The DG-ID number 00 detects signals with all ID numbers. Normally setting the ID number to “00” for both transmit and receive will permit reception of the signals from all other stations using the digital C4FM mode, regardless of the transmit DG-ID number settings of the other stations.

Also note that when the receive DG-ID number of the transceiver is set to a DG-ID number other than “00”, received signals that do not have the same DG-ID number may not be heard.

When accessing a C4FM digital repeater controlled by a DG-ID number, set the transmit DG-ID number of the FTM-500DR/DE to that of the repeater input. Even in that case, if the receive DG-ID number of the FTM-500DR/DE is set to “00”, all the downlink signals from the repeater may be received.

Communicating with the DG-ID feature



- Digital C4FM mode transceivers compatible with the DG-ID function are required in order to utilize this function.
- If the firmware is not compatible with the DG-ID function, update to the latest firmware to use the DG-ID function. The latest firmware is available on the YAESU website.

Setting the transmit and receive DG-ID number to “00” to communicate with all other stations using C4FM digital mode

1. Press and hold the **GM** key.
The DG-ID number setting screen will be displayed.



While setting the DG-ID number, pressing and holding the **FUNC** knob will set the transmit and the receive DG-ID numbers to “00”.

2. If the transmit DG-ID (DG-ID TX) number is not set to “00”, press the **FUNC** knob, and then rotate the **FUNC** knob to set “00”.
3. Press the **FUNC** knob again, and rotate the **FUNC** knob to select the receive DG-ID (DG-ID RX).
4. If the receive DG-ID number is not set “00”, press the **FUNC** knob, then rotate the **FUNC** knob to set “00”.
5. Press the **DIAL** knob, **SUB DIAL** knob or **PTT** switch to save the settings and return to normal operation.

Press and hold

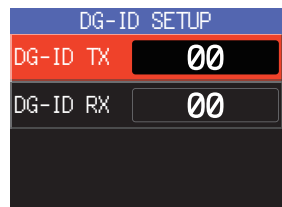
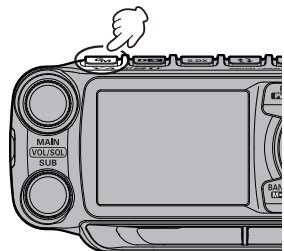

6. To check whether or not other stations are operating within communications range, press the **GM** key to turn the GM (Group Monitor) function ON.
 - The other stations must also have the GM (Group Monitor) function ON.
 - Refer to the separate Operating Manual GM Edition for details on how to use the GM function (download the manual from our YAESU website).
7. Press the **GM** key to turn the GM (Group Monitor) function OFF and return to normal operations.



- If the receive DG-ID is set to a number other than “00”, only signals with that DG-ID will be received. Normally, set the receive DG-ID number to “00” except when communication is desired only with group members.
- The transmit and receive DG-ID default number is set to “00”.

Communicate only with the specific members by setting the DG-ID number except for “00”

Example: Set the DG-ID number of to “50”

1. Press and hold the **GM** key.
The DG-ID number setting screen will be displayed.



While setting the DG-ID number, pressing and holding the **FUNC** knob will set the transmit and the receive DG-ID numbers to “00”.

2. Press the **FUNC** knob, and then rotate the **FUNC** knob to set transmit DG-ID (DG-ID TX) number to “50”.
3. Press the **FUNC** knob again, then rotate the **FUNC** knob to select the receive DG-ID (DG-ID RX).
4. Press the **FUNC** knob, and then rotate the **FUNC** knob to set receive DG-ID (DG-ID RX) number to “50”.
5. Press the **DIAL** knob, **SUB DIAL** knob or **PTT** switch to save the settings and return to normal operation.

Tuning to the same frequency and setting the same DG-ID for all the group members will enable communication between the members and exclude other signals.

- Press the **GM** key to turn the GM (Group Monitor) function ON and check whether or not other stations that are operating on frequency, with the GM (Group Monitor) function ON, and have the same GD-ID number setting, are in the communication range.
- The other stations must also have the GM (Group Monitor) function ON.

Press and hold

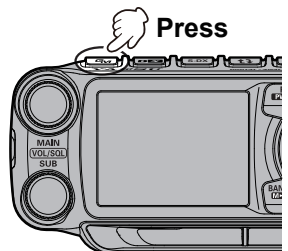
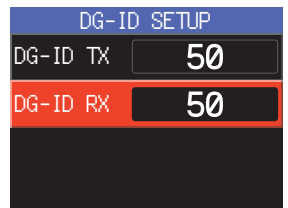
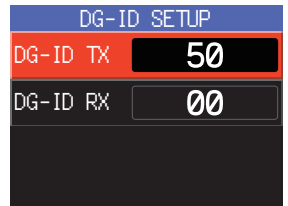
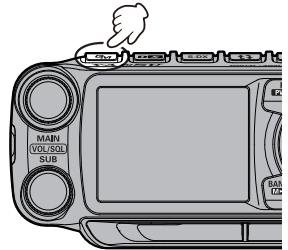

6. Press the  key to turn the GM (Group Monitor) function OFF and return to the normal operation. While operating in the GM function, the call sign and the signal strength of a maximum 24 stations with the GM function turned ON, and that are within the communication range, may be checked.



For details on how to set each item, refer to “FTM-500DR/DE GM Function Instruction Manual” which is available on the Yaesu website.

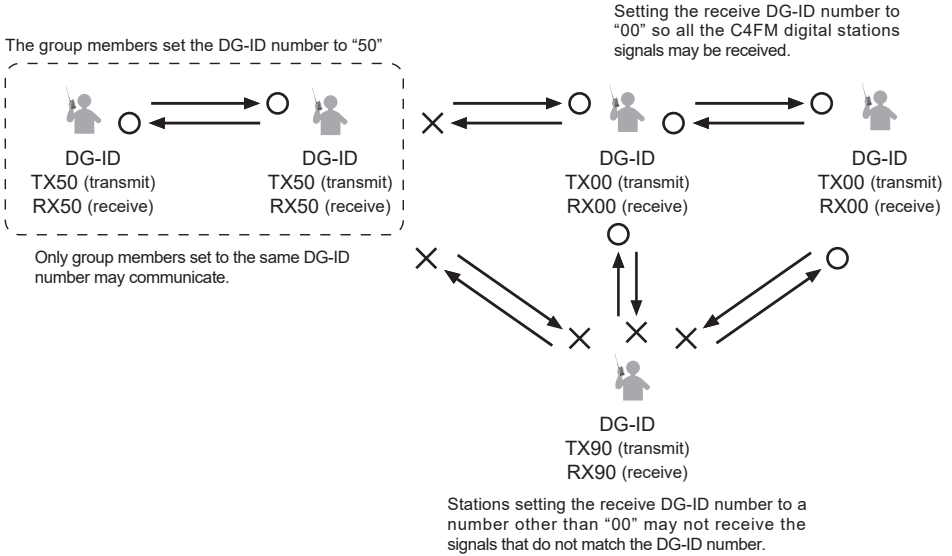

Communicating Via the Repeater

The transceiver includes an ARS (Automatic Repeater Shift) function which automatically sets the repeater operation when the receiver is tuned to the repeater frequency.

1. Set the receive frequency to the repeater frequency “-” or “+” appears on top of the display.
2. “-” or “+” and “TN” icons may automatically appear above the frequency.
3. Speak into the microphone while pressing and holding the PTT switch.

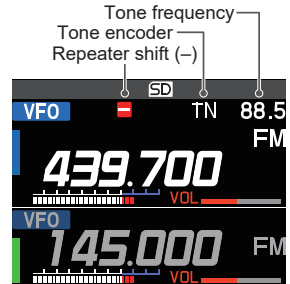

● Reverse function

The “reverse” state temporarily reverses the transmit and receive frequencies. This allows checking to find if direct communication with the other station is possible.

1. Press the **FUNC** knob.
2. Touch [RPT-R].
Or rotate the **FUNC** knob to select [RPT-R], then press the **FUNC** knob.
 - The transmit and receive frequencies are temporarily reversed (“reverse” state).
 - In the “reverse” state, the “-” or “+” blinks on the display.
3. To release the reverse state, repeat the above steps again.

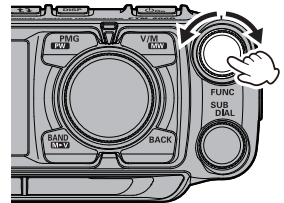

- The repeater settings may be changed from the Setup Menu.
Setup Menu [26 RPT SHIFT]: Allows setting the repeater shift direction.
Setup Menu [27 RPT SHIFT FREQ]: Allows changing the repeater shift offset.
- Function Menu [ARS]: The ARS function may be set to OFF
- Function Menu [TONE]: CTCSS Tone frequency



● Tone Calling (1750 Hz)

If your transceiver is FTM-500DE (European version), press and hold in the [P4] key on the microphone (in factory default setting) to generates a 1750 Hz burst tone to access the European repeater. The transmitter will automatically be activated, and a 1750Hz audio tone will be superimposed on the carrier. Once access to the repeater has been gained, you may release the switch, and use the switch for activating the transmitter thereafter. If you need to access the repeaters which requires a 1750Hz burst tone for access by the FTM-500DR (USA/Asian versions), you can set the program key on the microphone to serve as a “T-CALL” key instead. To change the configuration of this switch, use setup menu [29 MIC PROGRAM KEY].

Using the Memory

The FTM-500DR/DE incorporates a Large number of memory channels that can register the operating frequency, communication mode, and other operational information.

- 999 Memory Channels
 - 5 Home Channels
 - 50 pairs PMS Memory Channels
- The memory auto grouping (MAG) function can automatically recall a list of memory channels from the same frequency band as a group.
- The PMG (Primary Memory Group) function displays the status of registered frequently used frequencies (received signal strength) in a bar graph.

The operating frequency and other operational information can be registered to each regular memory channel, home channel, or PMS memory channel:

- Operating frequency
- Transmitter output
- TX/RX DG-ID
- Memory channel skip information
- Communication Mode
- Memory tag
- Tone information
- Frequency Step
- Repeater Shift
- DCS information

NOTE

Back up the stored contents to a microSD memory card. For details on backing up to a microSD card. See the Advanced Manual for details on backing up to a microSD card.

Writing to memory

1. Set the frequency to write to memory.
2. Press and hold the  key.
The memory channel list appears.



The memory channel list can also be displayed by the following operations:

Press the **FUNC** knob → Touch **[KEYPAD]** →
Select **[MEMORY CH LIST]** → Press the **FUNC** knob
The last used memory channel is selected.

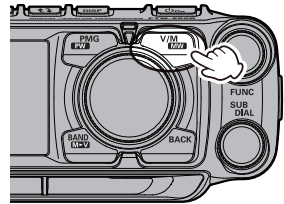

The lowest available number is selected. To select another channel, rotate the **FUNC** knob to select the memory channel number to be written.

- Rotate the **SUB DIAL** knob, or press the [UP] or [DWN] key on the microphone to fast-forward in 10-channel steps.
- Press the number keys on the microphone to quickly select a memory channel as shown in the example below:

Press the **[1]** key: Memory channel **100**

Press the **[A]** key: PMS Memory channel **L01**

- When **[HOM]** at the top of the memory channel list is selected, the HOME channel of the current frequency band can be overwritten.

MEMORY CH LIST	
001	145.000
002	. ---
003	. ---
004	. ---



For already written memory channels, the writing frequency is displayed.



- Press and hold the  key.
Or press the **FUNC** knob to display a popup. Make sure that **[WRITE]** is highlighted and press the **FUNC** knob. If you attempt to register a frequency to a memory channel that already contains frequency data, “**OVERWRITE?**” will appear on the screen. Rotate the **FUNC** knob to select **[OK]**, then press the **FUNC** knob to overwrite the memory channel.



- The memory is stored, and the screen returns to the previous screen.

Recall memory (There are three ways)

(1) Press key or touch **VFO** to recall

- Press the  key or touch **VFO**.
The last used memory channel is recalled.
- Rotate the **DIAL** knob to select the memory channel to recall.
Press and then turn the **DIAL** knob to select in 10 channel steps.
- Press the  key again or touch **M-ALL**, **M-AIR**, **M-VHF**, **M-UHF** or **OTHER** to return to VFO mode.

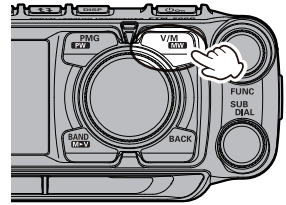

(2) Press the **FUNC** knob to recall from the function menu

- Press the **FUNC** knob.
- Touch **[KEYPAD]**.
Or rotate the **FUNC** knob, select **[KEYPAD]**, then press the **FUNC** knob to display the direct frequency input screen or the memory channel number input screen.
- Touch **[MEMORY CH LIST]**.
Or rotate the **DIAL** knob to select **[MEMORY CH LIST]** then press the **DIAL** knob to display the memory channel list.

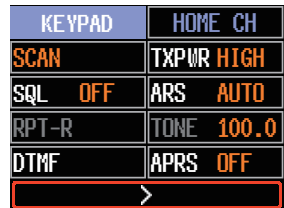

The memory channel list can also be displayed by the following operations.

Press and hold the **FUNC** knob → Touch **[20 MEMORY LIST]**

- Rotate the **FUNC** knob, select the memory channel to recall.
 - Rotate the **SUB DIAL** knob, or press the **[UP]** or **[DWN]** key on the microphone to fast-forward in 10-channel steps.
 - Press the number keys on the microphone to quickly select a memory channel as shown in the example below:
Press the **[1]** key: Memory channel **100**
Press the **[A]** key: PMS Memory channel **L01**
- Press the **FUNC** knob. A pop-up with **[RECALL]** highlighted appears. Press the **FUNC** knob or touch **[RECALL]**.
The selected memory channel will be recalled.



(3) Recalling a memory by directly entering the channel number

● Recalling a memory on the keypad screen

1. Press the **FUNC** knob.
2. Touch [KEYPAD].
Or rotate the **FUNC** knob, select [KEYPAD], then press the **FUNC** knob to display the memory channel number input screen.
3. Touch or rotate the **FUNC** knob to select a memory channel number, then press the **FUNC** knob.

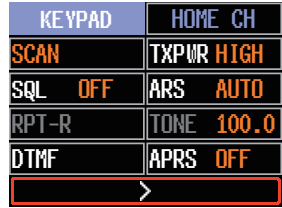

(Example) When recalling memory channel “123”.
Rotate the **FUNC** knob to select [1] → Press the **FUNC** knob



Rotate the **FUNC** knob to select [2] → Press the **FUNC** knob



Rotate the **FUNC** knob to select [3] → Press the **FUNC** knob

(Example) When recalling memory channel “16”.

Rotate the **FUNC** knob to select [1] → Press the **FUNC** knob



Rotate the **FUNC** knob to select [6] → Press the **FUNC** knob



Press and hold the **FUNC** knob

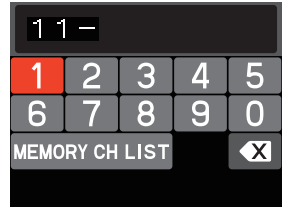

● Recall a memory by directly inputting channels using the numeric keys on the microphone

Press the numeric keys “0” to “9” in the memory mode to enter the memory channel.

(Example) When recalling memory channel “123”.

Press the [1] → [2] → [3] key.

(Example) When recalling memory channel “16”.

Press the [1] → [6] key.



Press and hold any numeric key.

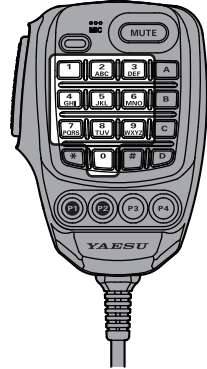

Press the **PTT** switch while entering a number to cancel the entry.

Copy memory channel information to VFO

Press and hold the  key while recalling memory. Copy the contents of the recalled memory channel to the VFO and enter VFO mode.

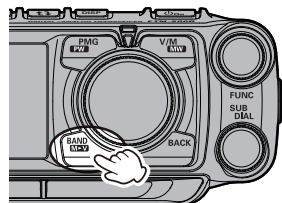

Displaying a list of memory channels in memory mode

Turning the **DIAL** knob in memory mode usually increases or decreases the memory channel number. Rotating the **DIAL** knob automatically displays the memory channel list and allows you to recall the desired memory channel while checking the contents of multiple memory channels.

1. Press and hold the **FUNC** knob.
2. Touch **[21 MEMORY LIST MODE]**.
Or rotate the **FUNC** knob to select the **[21 MEMORY LIST MODE]**, and then **FUNC** knob.
3. Rotate the **FUNC** knob to set "ON".
4. Press the **DIAL** knob, **SUB DIAL** knob or **PTT** switch to save the settings and return to normal operation.

To return to normal up / down operation, set "OFF" in step 3 of the above operation.

Recall only memories in the same frequency band (Band) using the memory auto grouping (MAG) function

With the memory auto grouping (**MAG**) function, only memory channels in the same frequency band (Band) can be called.

In the memory mode, each time the  key is pressed, only memory channels of the specified frequency band are automatically recalled as a group, as shown below:

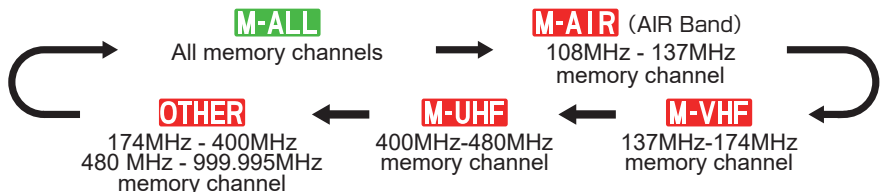
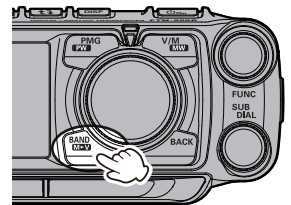

When "M-ALL" is selected, the MAG function is turned OFF and all memory channels can be recalled.

Group	Selectable Memory Channels
M-ALL	All memory channels.
M-AIR	AIR band (108 - 137MHz) memory channels only.
M-VHF	144MHz band (137 - 174MHz) memory channels only.
M-UHF	430MHz band (400 - 480MHz) memory channels only.
OTHER	174MHz to 400MHz and 480MHz to 999.995MHz Memory channels.

Edit memory

● Edit memory tag

Memory name tags, such as a call sign or broadcast station name may be assigned to the memory channels and home channels. Input a memory tag using up to 16 characters. Alphabetic characters (upper and lowercase), Numbers and Symbols may be entered to the memory name tag.

1. Press and hold the  key.

The memory channel list appears. The lowest available number is selected.

The memory channel list can also be displayed by the following operations:



Press the **FUNC** knob → Touch **[KEYPAD]** →

Select **[MEMORY CH LIST]** → Press the **FUNC** knob

The last used memory channel is selected.

2. Rotate the **FUNC** knob to select the memory channel for editing the memory tag, then press the **FUNC** knob.
 - Rotate the **SUB DIAL** knob, or press the [UP] or [DWN] key on the microphone to fast-forward in 10-channel steps.

3. A popup will appear. Touch **[EDIT]** or rotate the **FUNC** knob to select **[EDIT]** then press the **FUNC** knob. The memory information appears.

4. Touch **[TAG]**.

Or rotate the **FUNC** knob to select **[TAG]**, then press the **FUNC** knob.

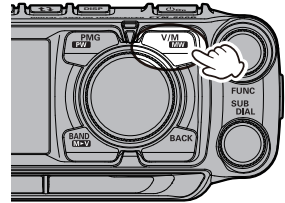

MEMORY CH LIST	
001	145.000
002
003
004

MEMORY CH LIST	
021	433.300 YAESU
022	433.620 FTM-500D
023	433.300 JA1YOE
024	433.100 433.200 DIGITAL

MEMORY CH LIST	
021	433.300 YAESU
022	433.620 FTM-500D
023	433.300 JA1YOE
024	433.100 433.200 DIGITAL

MEMORY INFORMATION	
RX FREQ	433.300
TX FREQ
TAG	YAESU
SCAN	YES
OK	BACK

- The character input screen is displayed. Rotate the **FUNC** knob to select a character, and press the **FUNC** knob to enter the character.

: moves the cursor to the left.

: moves the cursor to the right.

: displays the alphabet keypad input screen.

: displays the numeric keypad input screen.

: displays the symbols keypad input screen.

: erases the character to the left of the cursor and moves the cursor to the left.



- See “Text input screen” on page 75 to input a memory tag.

5. When input is complete, press and hold the **FUNC** knob to save the characters and return to “**MEMORY INFORMATION**” screen.

6. Touch **[OK]**.

Or rotate the **FUNC** knob to select **[OK]**, then press the **FUNC** knob.

7. A confirmation pop-up appears. Touch **[OK]** or select **[OK]** then press the **FUNC** knob to complete the memory tag entry.



The Memory tag is only displayed on the operating band (upper section on the display).

● Clearing Memories

1. Press and hold the key.

The memory channel list appears. The lowest available number is selected.

The memory channel list can also be displayed by the following operations:



Press the **FUNC** knob → Touch **[KEYPAD]** →

Select **[MEMORY CH LIST]** → Press the **FUNC** knob

The last used memory channel is selected.

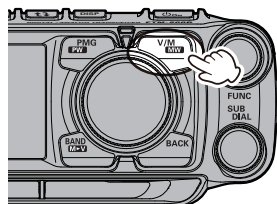

2. Rotate the **FUNC** knob to select the memory channel from which the data is to be cleared, and press the **FUNC** knob.

- Rotate the **SUB DIAL** knob, or press the [UP] or [DWN] key on the microphone to fast-forward in 10-channel steps.

MEMORY CH LIST		
021	433.300	YAESU
022	433.620	FTM-500D
023	433.300	JA1YDE
024	433.100 433.200	DIGITAL

3. A popup will appear. Touch **[DELETE]** or rotate the **FUNC** knob to select **[DELETE]** then press the **FUNC** knob.

Confirmation screen “**DELETE?**” is displayed.

Rotate the **FUNC** knob to select **[OK]**, then press the **FUNC** knob.

MEMORY CH LIST		
021	433.300	YAESU
022	433.620	FTM-500D
023	433.300	JA1YDE
024	433.100 433.200	DIGITAL

Overlaid on the table is a confirmation screen with the following options:

RECALL	YAESU
WRITE	FTM-500D
EDIT	JA1YDE
DELETE	DIGITAL



Data on memory channel One, and the Home channel may not be cleared.

Recalling the Home Channels

● Recall from the Function List

1. Press the **FUNC** knob.
2. Touch **[HOME CH]**.
Or rotate the **FUNC** knob, select **[HOME CH]**, then press the **FUNC** knob.
 - Or press and hold the **FUNC** knob → “**19 HOME CH**”
 - “**HOME**” and the home channel frequency of the currently selected band appears on the LCD.

KEYPAD	HOME CH
SCAN	TXPWR HIGH
SQL OFF	ARS AUTO
RPT-R	TONE 100.0
DTMF	APRS OFF
➤	

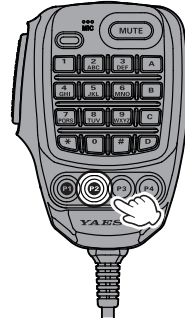

● Recall with the programmable key on the microphone

1. Press the **[P2]*** key on the microphone.
* This is the factory setting. This function can also be assigned to the **[P1]**, **[P3]** or **[P4]** key (see page 25).
“**HOME**” and the home channel frequency of the currently selected band appears on the LCD.
2. Press the **[P2]** key again, to return to the previous frequency.



While recalling the home channel, rotate the **DIAL** knob to transfer the home channel frequency to the operating band VFO.

Changing the Home Channel Frequency

1. Set the frequency and the operating mode to be stored as a home channel.
2. Press the **FUNC** knob.
Or press and hold the  key and proceed to step 5.
3. Touch **[KEYPAD]**.
Or rotate the **FUNC** knob to select **[KEYPAD]**, then press the **FUNC** knob.
The frequency input screen or memory channel input screen appears.
4. Rotate the **DIAL** knob to select **[MEMORY CH LIST]**, then press the **DIAL** knob.
The memory channel list appears.
5. Rotate the **FUNC** knob to select **[HOM]** displayed at the top of the memory channel list.
 - Rotate the **SUB DIAL** knob, or press the **[UP]** or **[DWN]** key on the microphone to fast-forward in 10-channel steps.
6. Press and hold the  key or press the **FUNC** knob to display a popup. Make sure that **[WRITE]** is highlighted and press the **FUNC** knob.
Confirmation screen “**OVER WRITE?**” is displayed.
7. Rotate the **FUNC** knob to select **[OK]**, then press the **FUNC** knob.
8. The contents of the home channel are changed and the previous screen returns.

KEYPAD	HOME CH
SCAN	TXPWR HIGH
SQL OFF	ARS AUTO
RPT-R	TONE 100.0
DTMF	APRS OFF
➤	

MEMORY CH LIST	
1	2
3	4
5	6
7	8
9	0
MEMORY CH LIST	✕

MEMORY CH LIST	
HOM 14	RECALL
001	WRITE
002	EDIT
003	DELETE

Split Memory

Two different frequencies, one for receive and another for transmit, can be registered to a memory channel.

1. Register the receive frequency to a memory channel first.
For additional details on registering to a memory channel, refer to page 44.
To edit a memory channel that has already been written, go to step 2.
2. Press and hold the  key.
The memory channel list appears.



The memory channel list can also be displayed by the following operations:
Press the **FUNC** knob → Touch [KEYPAD] → Select [MEMORY CH LIST] → Press the **FUNC** knob

3. Rotate the **FUNC** knob to select the channel number that the receive frequency was registered to on step 1, and press the **FUNC** knob.
4. Touch [EDIT].
Or rotate the **FUNC** knob to select [EDIT], then press the **FUNC** knob.



5. Touch [TX FREQ].
Or rotate the **FUNC** knob to select [TX FREQ], then press the **FUNC** knob.



6. Set the transceiver to the desired transmit frequency.
7. Touch [OK].
Or rotate the **FUNC** knob to select [OK], then press the **FUNC** knob.
8. Confirmation screen is displayed, touch [OK] or press the **FUNC** knob.

The display returns to the memory channel list screen, and the receive frequency is displayed on the upper side, and the transmit frequency is displayed on the lower side.

9. Press the **DIAL** knob, **SUB DIAL** knob or **PTT** switch to save the settings and return to normal operation.
When recalling the split memory “” is displayed on the LCD.

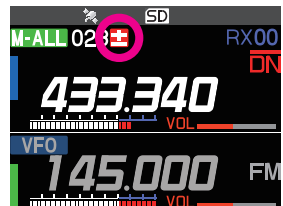
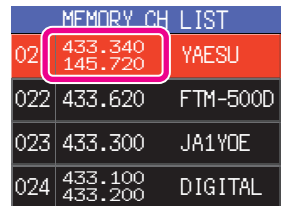

While operating the split memory, to reverse the transmit and receive frequencies temporarily:
Press the **FUNC** knob → [RPT-R]

When reversing the frequencies, “” will blink.



Scanning Function

The FTM-500DR/DE supports the following three scanning functions:

- VFO Scan
- Memory Scan
- Programmable Memory Scan (PMS)

VFO Scan / Memory Scan

To find frequencies where there are signals in VFO mode or Memory mode:

1. Press the  key to set the band to be scanned as the operation band.
 2. Press the  key to select the “VFO mode” or “Memory mode”.
 3. Press the **FUNC** knob → Touch “**SCAN**”.
- Or press the **FUNC** knob → “**SCAN**” → Press the **FUNC** knob.

KEYPAD		HOME CH	
SCAN		TXPR HIGH	
SQL	OFF	ARS	AUTO
RPT-R		TONE	100.0
DTMF		APRS	OFF
START			

Or press and hold the microphone **[UP]** or **[DWN]** switch to start scanning.

- If the **DIAL** knob is rotated while scanning is in progress, the scanning will continue up or down in frequency according to the direction of the **DIAL** Knob rotation.
- When a signal is received, the scan pauses, the frequency flashes, and the scan starts again after about 3 seconds. In the USA version, the scan will continue to pause while receiving the signal.

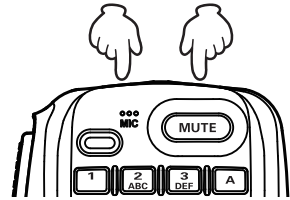

● Stop scanning

1. Press the **FUNC** knob → Touch “**SCAN**”.
- Or press the **FUNC** knob → “**SCAN**” → Press the **FUNC** knob.
- Or press **PTT** or the **[UP]** / **[DWN]** keys on microphone.

- If the scan has paused on a signal, rotating the **DIAL** knob will cause scanning to resume instantly.
- If the transceiver is turned **OFF** while scanning, when the transceiver is turned **ON**, scanning will resume.
- If you call the Function List or Setup Menu during scanning, the **SCAN** item is automatically selected and you cannot select any other item.



Setting the Receive Operation When Scanning Stops

1. Press and hold the **FUNC** knob.
 2. Touch **[56 SCAN RESUME]**.
- Or rotate the **FUNC** knob to select **[56 SCAN RESUME]**, then press the **FUNC** knob.
3. Rotate the **FUNC** knob to select the hold time after the scan is paused:

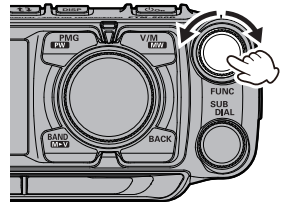

• **BUSY**

The signal is received until the signal fades out. Two seconds after the signal fades out, scanning resumes.

• **HOLD**

Scanning stops and tuning remains on the current receive frequency (Scanning does not resume).

- **1 sec / 3 sec / 5 sec**

The signal is received for a specified period of time, and then scanning resumes.

Factory default setting: **BUSY**

4. Press the **DIAL** knob, **SUB DIAL** knob or **PTT** switch to save the settings and return to normal operation.



The above settings are common for VFO scan, memory scan and programmable memory scan (PMS).

Skip Memory Channels

Each memory channel can be set to be skipped during memory scan.

1. Press and hold the key.
The memory channel list appears.



The memory channel list can also be displayed by the following operations:

Press the **FUNC** knob → Select **[KEYPAD]** →

Press the **FUNC** knob → Select **[MEMORY CH LIST]** → Press the **FUNC** knob

2. Rotate the **FUNC** knob to select the memory channel number that you do not want to scan, and press the **FUNC** knob.
3. Touch **[EDIT]**.
Or rotate the **FUNC** knob to select **[EDIT]**, then press the **FUNC** knob.
4. Touch **[SCAN]**.
Or rotate the **FUNC** knob to select **[SCAN]**, then press the **FUNC** knob to select **[NO]**.
5. Touch **[OK]**.
Or rotate the **FUNC** knob to select **[OK]**, then press the **FUNC** knob.
6. When the confirmation screen is displayed, touch **[OK]** or press the **FUNC** knob.
When the memory channel set as the skip memory is called, the “” icon is displayed.



To cancel the skip memory, set it to “YES” in step 5 above.

Programmable Memory scan (PMS)

This function scans only the range of frequencies between the lower and upper limits registered in a pair of PMS Programmable Memory channels. 50 sets of PMS memory channels (L01/U01 to L50/U50) are available.



For additional details on the Programmable Memory Scan (PMS) and Memory Bank Scan, refer to the Advanced Manual which may be downloaded from the Yaesu website.

Convenience Features

Bluetooth® Operation

The **FTM-500DR/DE** has built-in **Bluetooth®** functionality. Hands-free operation is possible using the optional **Bluetooth®** headset (**SSM-BT10**) or a commercially available **Bluetooth®** headset.



The operation of all commercially available **Bluetooth®** headsets cannot be guaranteed.

Pairing the Bluetooth® Headset

When using the **Bluetooth®** Headset for the first time, the **Bluetooth®** Headset and the **FTM-500DR/DE** must be paired.

This step is only necessary when first connecting the headset.

1. To start the **Bluetooth®** headset in pairing mode.

SSM-BT10: Press and hold the **Multi-Function Button** for 3 seconds, until the **SSM-BT10** LED blinks red/blue alternately.

Press and hold the Multi Function Button for 3 seconds to turn ON.



2. Press and hold the **FUNC** knob.

3. Touch [111 Bluetooth].

Or rotate the **FUNC** knob to select [111 Bluetooth], then press the **FUNC** knob.

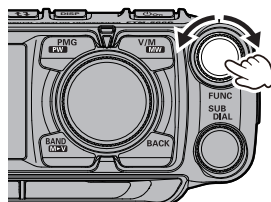

4. Press the **FUNC** knob and set [Bluetooth] to "ON".
The setting items are displayed.
5. Press the **FUNC** knob.
6. Rotate the **FUNC** knob to select [DEVICE], then press the **FUNC** knob.

OPTION	
111 Bluetooth	>
112 VOICE MEMORY	
113 FVS REC	
114 TRACK SELECT	
>	

OPTION	
111 Bluetooth	
Bluetooth	ON
DEVICE	
STATUS	Disconnected
AUDIO	AUTO

7. Press the **SUB DIAL** knob.
The search starts, and the model name of the found **Bluetooth**® device is displayed in the list.
8. When the headset to be connected is displayed, press the  key to stop searching.

DEVICE LIST
SSM-BT10
yaesu-01
yaesu-02
Searching

9. Rotate the **FUNC** knob to select the **Bluetooth**® headset to be connected.
10. Press the **SUB DIAL** knob.
11. Rotate the **SUB DIAL** knob to select [**CONNECT**].
12. Press the **SUB DIAL** knob.
13. To return to the normal operation screen.

DEVICE LIST
SSM-BT10
yaesu-01
yaesu-02
CONNECT DEL ALL SEARCH

While connected to a **Bluetooth**® headset, the  icon lights up on the **FTM-500DR/DE** screen, and the received audio and operation beep will be heard from the **Bluetooth**® headset.

- When the connection is complete, the [**DEVICE**] field will display “Name of the connected **Bluetooth**® headset” and the [**STATUS**] field will display “Connected”.
- The LED of **SSM-BT10** blinks blue. The pairing is completed.

OPTION
111 Bluetooth
Bluetooth ON
DEVICE SSM-BT10
STATUS Connected
AUDIO AUTO

● **Disable the Bluetooth® function**

To cancel the **Bluetooth**® operation, just repeat the above procedures, selecting “**OFF**” in step 4 above.

● **Subsequent Bluetooth® headset connection when the power is turned ON**

- When the power is turned **OFF** while the **Bluetooth**® headset is connected, the next time the power is turned **ON**, the same **Bluetooth**® headset is searched for and automatically connected when found.
- If the **Bluetooth**® headset cannot be found, the  icon blinks on the screen. If the power of the same **Bluetooth**® headset is turned **ON** in this state, it will connect automatically. If not, turn the **FTM-500DR/DE** and **Bluetooth**® headset **OFF** and then **ON** again.
- To connect to other **Bluetooth**® headsets, refer to “Connect with another **Bluetooth**® headset” on page 58.

Transmit operation by pressing the button on the Bluetooth® headset (when the VOX function is OFF)

When the **VOX** function is **OFF**, pressing the “Call button”* on the **Bluetooth®** headset once will engage the **FTM-500DR/DE** in transmit, and then a call can be made using the **Bluetooth®** headset.

Press the “Call button”* again to return the **FTM-500DR/DE** to receive.

*The button name may differ depending on your **Bluetooth®** headset.

SSM-BT10: When the **Multi-Function** Key is pressed, a beep will sound and the **FTM-500DR/DE** will continuously transmit.
Press the **Multi-Function** Key again, a beep will sound and the **FTM-500DR/DE** will return to receive mode.

Press briefly to transmit



Hands-free VOX operation with a Bluetooth® headset

When **FTM-500DR/DE VOX** (automatic voice transmission) function is turned **ON**, the **Bluetooth®** headset can perform hands-free operation and transmit automatically just by talking. Turn the **VOX** function **ON** according to “VOX Operation” instructions.



The **VOX** function is commonly used for the **Bluetooth®** headset and microphone.

If you do not use the **Bluetooth** headset and do not want to use the **VOX** function with the microphone, set this to “**OFF**”.

VOX Operation

Using a **Bluetooth®** headset, you can transmit hands-free automatically, just by speaking into the microphone.

Setting VOX function

1. Press and hold the **FUNC** knob.
2. Touch [11 VOX]
Or rotate the **FUNC** knob to select [11 VOX], then press the **FUNC** knob.
3. Rotate the **FUNC** knob to select [VOX], then press the **FUNC** knob.
4. Rotate the **FUNC** knob to select “**LOW**” or “**HIGH**”.

OFF : **VOX** function **OFF**

LOW : **VOX** function **ON** (**VOX** Gain Level “**LOW**”)

HIGH : **VOX** function **ON** (**VOX** Gain Level “**HIGH**”)

When set to “**LOW**” or “**HIGH**”, the sound is automatically transmitted by voice from the connected **Bluetooth®** headset. When not connected to a **Bluetooth®** headset, the sound from the microphone is automatically transmitted.

5. Press the **DIAL** knob, **SUB DIAL** knob or **PTT** switch to save the settings and return to normal operation.

● **Disable the VOX function**

To cancel **VOX** and return to **PTT** operation, just repeat the above procedures, selecting “**OFF**” in step 4 above.

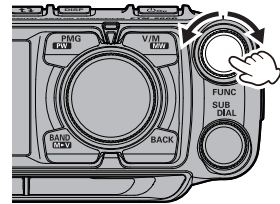

TX	
11 VOX	
VOX	OFF
DELAY	0.5s
VOX MIC	FRONT

Set the VOX (Voice Operated Transmit) delay time

During transmissions using the **VOX** (Voice Operated Transmit) function, set the time to return to receive when speaking is paused:

1. Press and hold the **FUNC** knob.
2. Touch **[11 VOX]**
Or rotate the **FUNC** knob to select **[11 VOX]**, then press the **FUNC** knob.
3. Rotate the **FUNC** knob to select **[DELAY]**, then press the **FUNC** knob.
4. Rotate the **FUNC** knob to select the delay time (the transmit-receive delay after the cessation of speech).
0.5sec / 1.0sec / 1.5sec / 2.0sec / 2.5sec / 3.0sec
Factory default value: "0.5sec".
5. Press the **DIAL** knob, **SUB DIAL** knob or **PTT** switch to save the settings and return to normal operation.

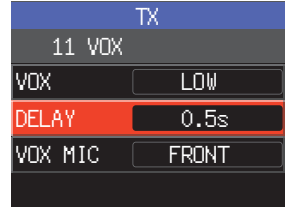
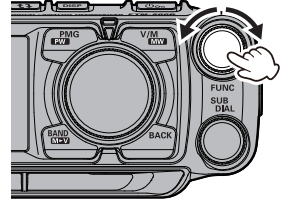

Connect with another Bluetooth® headset

1. Turn the **Bluetooth**® headset you are currently using OFF.
2. Press and hold the **FUNC** knob.
3. Touch **[111 Bluetooth]**.
Or rotate the **FUNC** knob to select **[111 Bluetooth]**, then press the **FUNC** knob.
4. Rotate the **FUNC** knob to select **[DEVICE]**, then press the **FUNC** knob.
5. Rotate the **SUB DIAL** knob to select **[SEARCH]**, then press the **SUB DIAL** knob.
Search **Bluetooth**® devices to display them in the device list in the following order:
 - (1) Already registered, searched and found **Bluetooth**® devices: white letters
 - (2) Searched and found new **Bluetooth**® devices: white letters
 - (3) Already registered but not found by search **Bluetooth**® devices: gray letters
6. When the headset to be connected is displayed, press the  key to stop searching.
7. Rotate the **FUNC** knob to select the desired Bluetooth® device.
8. Press the **SUB DIAL** knob.
9. Rotate the **SUB DIAL** knob to select **[CONNECT]**, then press the **SUB DIAL** knob to connect.

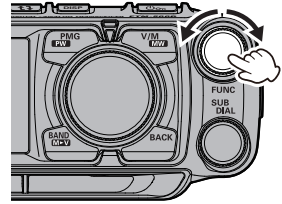

● Delete all registered (paired) Bluetooth® devices from the list

1. Press and hold the **FUNC** knob.
2. Touch **[111 Bluetooth]**.
Or rotate the **FUNC** knob to select **[111 Bluetooth]**, then press the **FUNC** knob.
3. Rotate the **FUNC** knob to select **[DEVICE]**, then press the **FUNC** knob.
4. Rotate the **SUB DIAL** knob to select **[DEL ALL]**, then press the **SUB DIAL** knob.
ALL **Bluetooth**® headsets are deleted from the device list.



All registered Bluetooth® headsets are deleted. Headsets cannot be deleted individually.

Bluetooth® received audio output

When a Bluetooth® headset is connected, the received audio can automatically be output from the headset only, or from both the headset and the transceiver speaker.

1. Press and hold the **FUNC** knob.
2. Touch [111 Bluetooth].

Or rotate the **FUNC** knob to select [111 Bluetooth], then press the **FUNC** knob.

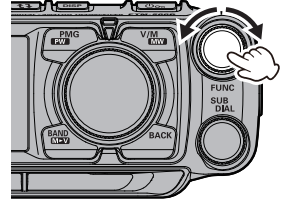

3. Rotate the **FUNC** knob to select [AUDIO], then press the **FUNC** knob.
4. Rotate the **FUNC** knob to select “AUTO” or “FIX”.

AUTO : The received audio comes from only the Bluetooth headset.

FIX : The received audio comes from both the Bluetooth headset and the speaker of this transceiver.

Factory default value: “AUTO”.

5. Press the **DIAL** knob, **SUB DIAL** knob or **PTT** switch to save the settings and return to normal operation.

OPTION	
111 Bluetooth	
Bluetooth	ON
DEVICE	
STATUS	Disconnected
AUDIO	AUTO

Dual Receive Function

While receiving on the VFO or Memory Channel, the transceiver checks for signals on the HOME channel once every 5 seconds. When a signal is received on the HOME channel, the priority scan pauses, allowing reception of the signal. When there is no signal on the HOME channel for about 5 seconds, the transceiver will resume Priority Scan.

The transceiver monitors signals on the frequency registered to the Priority HOME Channel, once approximately every 5 seconds.

VFO or Memory channel

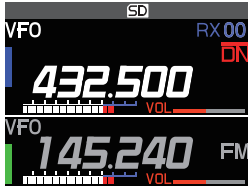

The transceiver returns to the previous frequency quickly and continues to receive mode when there is no signal.

HOME channel (Priority Channel)

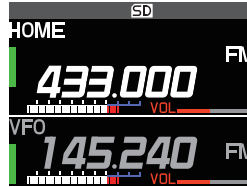

When the transceiver receives a signal on the frequency registered to the priority memory channel, dual reception stops and signal receiver switches to priority memory channel.

● Activating Priority Scan

1. Press and hold the **FUNC** knob.
2. Touch [52 DUAL RCV MODE].
Or rotate the **FUNC** knob to select [52 DUAL RCV MODE], then press the **FUNC** knob.
3. Rotate the **FUNC** knob to select [PRIORITY SCAN], then press the **FUNC** knob.
4. Press the **DIAL** knob, **SUB DIAL** knob or **PTT** switch to save the settings and return to normal operation.

● Disable the Priority Scan function

To cancel Priority Scan, just repeat the above procedures, selecting "OFF" in step 3 above.

Using the Voice Recorder

With the voice recording function, the received audio of the other station, and/or the transmit audio of this unit is recorded on the MicroSD memory card. The recorded file can be played back with the **FTM-500DR/DE** or the MicroSD memory card can be taken out and used on a PC. Once recording is started, it continues until recording is stopped, or the capacity of the MicroSD card is full.

● About the file

- The audio file is saved in the “**VOICE**” folder on the MicroSD card.
- The file is a Wave sound format (extension: wav).
- The file name is “YYYYMMDDmmhhss.wav” (YYYY: year, MM: month, DD: day, hh: hour, mm: minute, ss: second) depending on the date and time when the recording started.



- When using the MicroSD memory card for the first time, please refer to “Formatting a MicroSD Memory Card” on page 36 for formatting.
- Since the date and time information is used for the voice recording function names and file timestamps when recording, it is recommended to set the date and time by following the procedure below:
Press and hold the **FUNC** knob → [30 DATE&TIME ADJUST]

Recording the receive audio

1. Press and hold the **FUNC** knob.
2. Touch [41 REC/STOP].
Or rotate the **FUNC** knob to select [41 REC/STOP], then press the **FUNC** knob.
 - “**REC**” is displayed, and the recording function starts.
3. Press the **DIAL** knob, **SUB DIAL** knob or **PTT** switch to save the settings and return to normal operation.
 - “**II**” is displayed at the top of the LCD and the unit enters the recording standby mode. When a signal is received, recording starts automatically.
 - During recording, the “**II**” indication changes to “**■**”.
 - With the factory default settings, the “**MAIN-band**” received audio is recorded.
 - Recording will be paused about 3 seconds after the squelch of the band that is recording is closed. Recording will resume when a signal is received.
 - The band or bands to be recorded, and whether or not to include the transmit audio in the recording may be selected in the set mode.

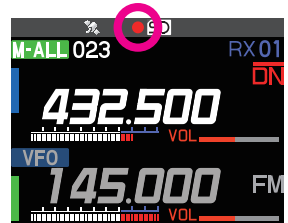
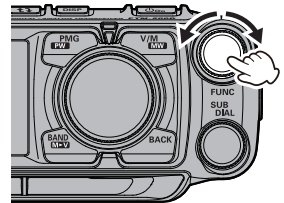

Recording is stopped when the transceiver is turned OFF.

● Disable the recording function

1. Press and hold the **FUNC** knob.
2. Touch [41 REC/STOP].
Or rotate the **FUNC** knob to select [41 REC/STOP], then press the **FUNC** knob.
 - “**STOP**” is displayed and the recording function is stopped.
 - When a new recording is started, a new file will be created.

Setting the Recording function

The band or bands to be recorded, and whether or not to include the transmit audio in the recording may be selected:

1. Press and hold the **FUNC** knob.
2. Touch [**40 RECORDING**].
Or rotate the **FUNC** knob to select [**40 RECORDING**], then press the **FUNC** knob.

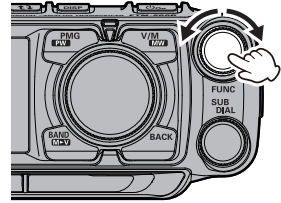

3. Rotate the **FUNC** knob to select [**BAND**], then press the **FUNC** knob to select the band to record.
MAIN : Record the MAIN-band received audio
SUB : Record the SUB-band received audio
MAIN+SUB : Record both MAIN-band and SUB-band received audio
4. Press the **FUNC** knob.
5. Rotate the **FUNC** knob to select [**MIC**], then press the **FUNC** knob to select “**ON**” or “**OFF**”.
ON : Record both transmit and receive audio
OFF : Record only the receive audio
6. Press the **DIAL** knob, **SUB DIAL** knob or **PTT** switch to save the settings and return to normal operation.

Playback the recorded audio



Playback is not possible during recording, so stop recording and follow the steps below to play back.

1. Press and hold the **FUNC** knob.
2. Touch [**63 LOG LIST**].
Or rotate the **FUNC** knob to select [**63 LOG LIST**], then press the **FUNC** knob.

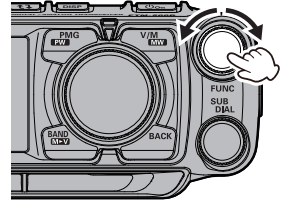

3. Rotate the **FUNC** knob to select [**VOICE**], then press the **FUNC** knob.
The recorded file will be displayed in a list.
 - Press the **SUB DIAL** knob, then rotate the **SUB DIAL** knob to select [**≡**], and press the **SUB DIAL** knob to display the Oldest file.
 - Press the **SUB DIAL** knob, then rotate the **SUB DIAL** knob to select [**TOP**], and press the **SUB DIAL** knob to display the latest file.
4. Rotate the **FUNC** knob to select the file to playback.



5. Press the **FUNC** knob.
 - Playback will begin
 - The receiver audio will not be heard during playback
 - Play back while recording is not possible.
 - Rotate the **FUNC** knob to select [**||**], then press the **FUNC** knob to pause playback.
 - Rotate the **FUNC** knob to select [**◀◀**] or [**▶▶**], then press the **FUNC** knob, to rewind or fast forward 5 seconds at a time.

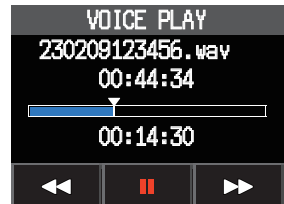

● Delete files

1. Rotate the **FUNC** knob in step 3 to select the file to be deleted, and then press the **SUB DIAL** knob.
2. Touch “**DEL**”.
Or rotate the **SUB DIAL** knob to select “**DEL**”, then press the **SUB DIAL** knob.
3. Touch “**OK**” twice.
Or rotate the **SUB DIAL** knob to select “**OK**”, then press the **SUB DIAL** knob.

GPS Function

The **FTM-500DR/DE** is equipped with a GPS (Global Positioning System) receiver. When receiving signals from GPS satellites, the current position (latitude, longitude, altitude) can be calculated and displayed within a tolerance of several meters. In addition, GPS receives the exact time from the satellite atomic clock.



Can be use the external GPS function by the following the procedure below:
Press and hold the **FUNC** knob → [**38 GPS DEVICE**] → "EXTERNAL".

WIRES-X function

WIRES (Wide-coverage Internet Repeater Enhancement System) is an Internet communication system which expands the range of amateur radio communications by connecting with a local **WIRES-X** Node station. The **FTM-500DR/DE** can communicate and exchange data via the internet with **WIRES-X** nodes worldwide. Use the News Station function to write (upload) and read (download) digital data (text, images and audio). When connected to a **WIRES-X** node station or room, the node name, room name, call sign of the other station, distance, and direction, are all displayed on this screen.



For details, refer to the separate WIRES-X Instruction Manual which is available on the Yaesu website.

APRS (Automatic Packet Reporting System) function

The **FTM-500DR/DE** uses a GPS receiver to acquire and display its position location information. The **APRS** feature uses the location information to transmit the position information, data and messages, using the format developed by Bob Bruninga WB4APR. Upon receiving an APRS report from a remote station, the direction and distance to the remote station from your station, the speed of the remote station, and other data sent by the remote station may be displayed on the LCD of your transceiver.

Setting several station parameters, such as the call sign and symbol is required before using the **APRS** function (initial settings).



For details, refer to the **APRS** Function Instruction Manual which is available on the Yaesu website.



For additional details on the following Functions, refer to the Advanced Manual which may be downloaded from the Yaesu website.

Tone squelch feature

The tone squelch opens the speaker audio only when a signal containing the specified **CTCSS** tone is received. By matching the **CTCSS** tone frequency with the partner stations, quiet standby monitoring is possible.

Digital Code squelch (DCS) feature

The **DCS** (Digital Coded Squelch) function allows audio to be heard only when signals containing the same **DCS** code are received.

New PAGER (EPCS) feature

This new feature allows calling specified stations only, by using a pager code that combines two **CTCSS** tones. Even when the person who is called is not near the transceiver, the information is displayed on the LCD to indicate that a call was received. When the call is received, the bell sounds.

Digital Personal ID (DP-ID) feature

Digital Personal ID (**DP-ID**) feature opens the speaker audio only when a **C4FM** signal set to the same **DP-ID** in the Digital Mode is received.

Using Setup Menu

The Set Mode permits configuring the various functions to accommodate individual operating needs and preferences.

Setup Menu Operation

1. Press and hold the **FUNC** knob.
The SETUP MENU screen will be displayed.
2. Touch the desired item in the Setup Menu.
Or rotate the **FUNC** knob to select the desired item in the Setup Menu, then press the **FUNC** knob.
 - “>” is displayed at the right of submenu items that have a deeper level of menu items.
 - Press the  key to return to the previous screen.
 - Rotate the **SUB DIAL** knob, or press the [UP] / [DWN] key on the microphone to scroll through the 17 categories in the Setup Menu (See below):

DISPLAY ↔ TX ↔ RX ↔ **MEMORY** ↔ **CONFIG** ↔
↔ **AUDIO** ↔ **SIGNALING** ↔ **SCAN** ↔ **DIGITAL** ↔
↔ **GM** ↔ **WIRES-X** ↔ **DATA** ↔ **APRS** ↔
↔ **SD CARD** ↔ **OPTION** ↔ **CLONE** ↔ **RESET**

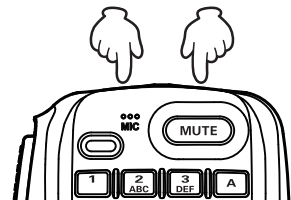
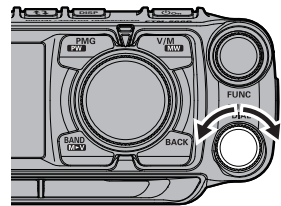
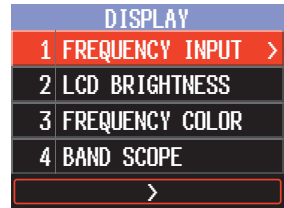
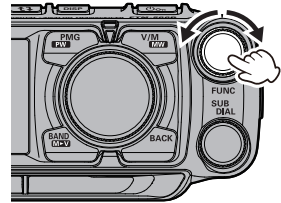

3. When there is no deeper level of menu items, go to step 4.
When there is a deeper level of menu items, rotate the **FUNC** knob to select the desired item, then press the **FUNC** knob.
4. Rotate the **FUNC** knob to change the setting value.
5. Press the **DIAL** knob, **SUB DIAL** knob or **PTT** switch to save the settings and return to normal operation.

Tables of Setup Menu Operations

Menu Number / Item	Description	Selectable options (Options in bold are the default settings)
DISPLAY		
1 FREQUENCY INPUT	Enter frequency directly or display memory channel list.	-
2 LCD BRIGHTNESS	Display and key button brightness.	MIN / MID / MAX
3 FREQUENCY COLOR	Set the font color of the operation band frequency.	WHITE / BLUE / RED
4 BAND SCOPE	Scope Display width setting.	NARROW / WIDE
5 LOCATION INFO	Switch between the compass screen and the latitude/longitude display screen when using the GPS and GM functions.	COMPASS / NUMERIC
6 COMPASS	Set the compass display of the smart navigation function and the APRS pop-up screen.	NORTH UP / HEADING UP
7 DISPLAY MODE	Back Track, Altitude, Timer/Clock or GPS Information screen display.	BACKTRACK / ALTITUDE / TIMER/CLOCK / GPS INFORMATION
TX		
8 TX POWER	Set the transmit power level.	LOW / MID / HIGH
9 AMS TX MODE	Set the AMS transmission mode.	AUTO / TX FM FIXED/ TX DN FIXED
10 MIC GAIN	Microphone sensitivity setting.	MIN / LOW / NORMAL / HIGH / MAX
11 VOX	VOX function settings.	VOX: OFF / LOW / HIGH DELAY: 0.5s / 1.0s / 1.5s / 2.0s / 2.5s / 3.0s VOX MIC: FRONT / REAR
12 AUTO DIALER	DTMF code automatic transmit setting.	ON / OFF
13 TOT	TX time out setting.	OFF / 1min / 2min / 3min / 5min / 10min / 15min / 20min / 30min
14 DIGITAL VW	Turn the VW mode selection ON or OFF.	ON / OFF
RX		
15 FM BANDWIDTH	Set the FM transmit modulation level.	WIDE / NARROW
16 RX MODE	Select the receive mode.	AUTO / FM / AM
17 SUB BAND		
SUB BAND	Sub Band ON/OFF (lower screen display).	OFF / ON
SUBBAND MUTE	Sub Band mute setting	OFF / ON
18 AUDIO EQUALIZER		
FRONT TONE	Adjust the sound quality of the Control head speaker	OFF / FLAT / HI PITCH / LO PITCH / BPF
REAR TONE	Adjust the sound quality of the Main body speaker	FLAT / HI PITCH / LO PITCH / BPF / 1kHz LPF / 700Hz LPF
REAR OUT	Output level of the main body speaker	0% to 100%
AESS PHASE	Sets the time delay between the audio output of the control head speaker and the main unit speaker.	OFF / 1.25ms to 20.00ms (10.00ms)
MEMORY		
19 HOME CH	Recall the home channel.	-
20 MEMORY LIST	Displays the Memory channel list screen.	-

Menu Number / Item	Description	Selectable options (Options in bold are the default settings)
21 MEMORY LIST MODE	Displays a list of memory channels in memory mode.	ON / OFF
22 PMG		
PMG TIMER	Scan resume time after there is no signal when receiving in PMG mode simultaneously.	1sec / 2sec / 3sec
PMG CLEAR	Cancel the registration of all PMG channels.	-

CONFIG

23 BEEP	Beep volume setting.	OFF / LOW / HIGH
24 BAND SKIP	Set the frequency bands that can be selected.	AIR: ON / OFF VHF: ON / OFF UHF: ON / OFF OTHER: ON / OFF
25 RPT ARS	Repeater auto shift setting.	OFF / AUTO
26 RPT SHIFT	Repeater shift direction setting.	AUTO / - / +
27 RPT SHIFT FREQ	Repeater TX offset setting.	0.00MHz to 99.95MHz
28 RPT REVERSE	Reverses the transmit and receive frequencies while working through a repeater.	NORMAL / REVERSE
29 MIC PROGRAM KEY	Microphone P1 / P2 / P3 / P4 buttons programable settings.	OFF / 2nd PTT / GM / REC/STOP / SCAN / HOME CH / RPT SHIFT / REVERSE / TX POWER / SQL OFF / T-CALL / VOICE* / D_X / WX / STN LIST / MSG LIST / REPLY / MSG EDIT / DW (*requires optional FVS-2) P1: 2nd PTT P2: HOME CH P3: D_X P4: WX (T-CALL: European version)
30 DATE&TIME ADJUST	Set the date and time.	-
31 DATE&TIME FORMAT	Set the date and time display formats.	Date: mmm/dd/yyyy / yyyy/mmm/dd / dd/mmm/yyyy / yyyy/dd/mmm Time: 24hour / 12hour
32 TIME ZONE	Time zone setting.	UTC -14:00 to ±0:00 to +14:00
33 STEP	Frequency tuning step.	AUTO / 5.00 kHz / 6.25 kHz / (8.33 kHz) / 10.00 kHz / 12.50 kHz / 15.00kHz / 20.00kHz / 25.00 kHz / 50.00 kHz / 100 kHz
34 CLOCK TYPE	Clock shift setting.	A / B
35 UNIT	Display unit setting.	METRIC / INCH (Depends on the transceiver version)
36 APO	Automatic power OFF time setting.	OFF / 0.5hour to 2.0hour (0.5 hour steps) 2.0hour to 12.0hour (1.0 hour steps)
37 GPS DATUM	GPS function positioning selection.	WGS-84 / TOKYO MEAN
38 GPS DEVICE	GPS receiver selection.	INTERNAL / EXTERNAL
39 GPS LOG	GPS access time setting.	OFF / 1sec / 2sec / 5sec / 10sec / 30sec / 60sec

AUDIO

40 RECORDING	Voice record function settings.	BAND: MAIN / SUB / MAIN+SUB MIC: ON / OFF
41 REC/STOP	Start and stop recording.	-

Menu Number / Item	Description	Selectable options (Options in bold are the default settings)
42 FRONT SP MUTE	Front speaker operation settings when external speakers are connected.	CONTINUE / AUTO MUTE

SIGNALING

43 DTMF	Load DTMF Autodialer Memories.	–
44 DTMF MEMORY	Set the DTMF auto dialer channel and code (16 characters).	1 to 9
45 SQL TYPE	Select a squelch type.	OFF / TONE ENC / TONE SQL / REV TONE / DCS / PR FREQ / PAGER / (DCS ENC) / (TONE DCS) / (DCS TSQL) *The options in the parentheses are available when the SQL expansion is ON.
46 TONE SQL FREQ or DCS CODE	Set the CTCSS Tone Frequency or the DCS code.	CTCSS: 67.0Hz to 254.1Hz (100Hz) DCS: 023 to 754
47 SQL EXPANSION	Separate squelch type setting for transmit and receive.	ON / OFF
48 PAGER CODE	Pager individual code settings.	RX-CODE 1: 01 - 05 - 50 RX-CODE 2: 01 - 47 - 50 TX-CODE 1: 01 - 05 - 50 TX-CODE 2: 01 - 47 - 50
49 PR FREQUENCY	User programmed reverse tone frequency.	300Hz - 1500Hz - 3000Hz
50 BELL RINGER	Recall sound length setting.	OFF / 1 time / 3 times / 5 times / 8 times / CONTINUOUS
51 WX ALERT	Weather alert operation setting.	ON / OFF

SCAN

52 SCAN	Engages the Scan operation.	-
53 DUAL RCV MODE	Dual receive operation setting.	OFF / PRIORITY SCAN
54 DUAL RX INTRVAL	Dual receive reception interval setting. (Only enabled when "53 DUAL RCV MODE" is set to "PRIORITY SCAN".)	0.5sec / 1.0sec / 2.0sec / 3.0sec / 5.0sec / 7.0sec / 10sec
55 PRIORITY REVERT	The transmission operation during dual receive always transmits on the home channel.	OFF / ON
56 SCAN RESUME	Set the resume operation after scanning stops on a signal.	BUSY / HOLD / 1sec / 3sec / 5sec

DIGITAL

57 DIGITAL POPUP	Information screen popup time.	OFF / 2sec / 4sec / 6sec / 8sec / 10sec / 20sec / 30sec / 60sec / CONTINUE
58 LOCATION SERVICE	Set whether to send your current location in digital mode.	ON / OFF
59 STANDBY BEEP	Standby Beep setting.	ON / OFF

GM

* Refer to the separate Operating Manual GM Edition for details on the functions.		
60 DP-ID LIST	Displays the DP-ID list screen.	–
61 RANGE RINGER	Set the bell sound when checking for stations within sphere of communications.	ON / OFF
62 RADIO ID	Specific transceiver ID is displayed.	– (cannot be edited)

Menu Number / Item	Description	Selectable options (Options in bold are the default settings)
63 LOG LIST	Display a list of recorded voices, received messages and images.	—

WIRES-X

* Refer to the separate Operating Manual WIRES-X Edition for details on the functions.

64 RPT/WIRES FREQ	Set the frequency to be used for Repeater / WIRES-X.	MANUAL / PRESET
FREQUENCY	Register the WIRES-X preset frequency.	Preset frequency: 146.550MHz 446.500MHz
65 SEARCH SETUP	Set the WIRES ROOM selection method.	HISTORY / ACTIVITY
66 EDIT CATEGORYTAG	Edit the category tag.	C1 to C5
67 DELETE ROOM/NODE	Delete a registered category.	C1 to C5
68 WIRES DG-ID	Set the DG-ID number for WIRES-X.	AUTO / 01 to 99

DATA

69 COM PORT	COM port settings	SPEED: 4800bps / 9600bps / 19200bps / 38400bps / 57600bps OUTPUT: OFF / GPS OUT / PACKET /WAYPOINT WP FORMAT: NMEA 6 / NMEA 7 /NMEA 8 / NMEA 9 WP FILTER: ALL / MOBILE / FREQUENCY / OBJECT/ITEM / DIGIPEATER / VoIP / WEATHER /YAESU / CALL RINGER / RANGE RINGER
70 DATA BAND	APRS/DATA band selection settings.	APRS: MAIN BAND / SUB BAND / THIS BAND / OTHER BAND DATA: MAIN BAND / SUB BAND / THIS BAND / OTHER BAND
71 DATA SPEED	APRS/DATA communication baud rate settings.	APRS: 1200 bps / 9600 bps DATA: 1200 bps / 9600 bps
72 DATA SQL	Squelch detection settings.	APRS: RX BAND / TX/RX BAND DATA: RX BAND / TX/RX BAND TX: ON / OFF

APRS

* Refer to the separate Operation Manual APRS Edition for details on the functions.

73 APRS DESTINATION	Model code display Non-editable.	APY500 (FIX)
74 APRS FILTER	Filter function settings.	Mic-E: ON / OFF POSITION: ON / OFF WEATHER: ON / OFF OBJECT: ON / OFF ITEM: ON / OFF STATUS: ON / OFF OTHER: ON / OFF RANGE LIMIT: OFF / 1 / 10 / 100 / 1000 / 3000 (km / mi) ALTNET: ON / OFF
75 APRS MSG TXT	Standard message text input.	1 to 8 channels
76 APRS MODEM	Set APRS function ON/OFF.	OFF / ON

Menu Number / Item	Description	Selectable options (Options in bold are the default settings)
77 APRS MUTE	Set audio mute for APRS band.	OFF / ON
78 APRS POPUP	Beacons and messages Pop-up display time setting.	BEACON: OFF / 3sec / 5sec / 10sec / HOLD MESSAGE: OFF / 3sec / 5sec / 10sec / HOLD MYPACKET: OFF / ON
79 APRS RINGER	Set bell sound when beacons are received.	TX BEACON: ON / OFF TX MESSAGE: ON / OFF RX BEACON: ON / OFF RX MESSAGE: ON / OFF MY PACKET: ON / OFF CALL RINGER: ON / OFF RANGE RINGER: OFF / 1 / 5 / 10 / 50 / 100 (km / mi) MSG VOICE: ON / OFF
80 APRS RINGER (CS)	Call sign setting for CALL RINGER.	1 - 8 stations
81 APRS TX DELAY	Data transmit delay time setting.	100ms / 150ms / 200ms / 250ms / 300ms / 400ms / 500ms / 750ms / 1000ms
82 APRS UNITS	APRS display unit settings.	POSITION: dd°mm.mm' / dd°mm'ss" DISTANCE: km / mile * SPEED: km/h / mph / knot* ALTITUDE: m / ft * BARO: hPa / mb / mmHg / inHg* TEMP: °C / °F * RAIN: mm / inch * WIND: m/s / mph / knot* *(Depends on the transceiver version)
83 BEACON INFO	Transmit beacon information settings.	AMBIGUITY: OFF / 1 digit / 2 digits / 3 digits / 4 digits SPEED/COURSE: ON / OFF ALTITUDE: ON / OFF
84 BEACON STATUSTXT	Status text input settings.	SELECT: OFF / TEXT 1 - 5 TX RATE: 1/1 - 1/8 / 1/2(FREQ)- 1/8(FREQ) TEXT 1 - 5: NONE / FREQUENCY / FREQ & SQL & SHIFT
85 BEACON TX SET	Beacon automatic transmit / Manual transmit switch.	AUTO: OFF / ON / (SmartBeaconing)* INTERVAL: 30 sec - 5 min - 60 min PROPORTIONAL: ON / OFF DECAY: ON / OFF LOW SPEED: 1 - 3 - 99 (km / mph / knot) RATE LIMIT: 5sec - 30sec - 180sec * The option in the parentheses is available when the "100 SmartBeaconing" is TYPE1, TYPE 2 or TYPE 3, and the "96 MY POSITION SET" is GPS.
86 DIGI PATH	Digital repeater route setting.	OFF / WIDE1-1 / WIDE1-1 , WIDE2-1 / PATH 1 / PATH 2 / PATH 3 / PATH 4 / FULL 1 / FULL 2
87 DIGI PATH 1	Digital repeater route address setting.	ADDRESS 1: -
88 DIGI PATH 2		ADDRESS 2: -
89 DIGI PATH 3		
90 DIGI PATH 4		
91 DIGI PATH FULL 1	Digital repeater route address setting.	ADDRESS 1: - to ADDRESS 8: -
92 DIGI PATH FULL 2		
93 CALLSIGN (APRS)	My call sign setting.	***** - **

Menu Number / Item	Description	Selectable options (Options in bold are the default settings)
94 MESSAGE GROUP	Group filter setting for received messages.	GROUP 1: ALL***** GROUP 2: CQ***** GROUP 3: QST***** GROUP 4: YAESU**** GROUP 5: ----- GROUP 6: ----- BULLETIN 1: BLN?***** BULLETIN 2: BLN?---- BULLETIN 3: BLN?----
95 MESSAGE REPLY	Set automatic response to received messages.	REPLY: OFF / ON CALLSIGN: *****_** REPLY TEXT: -
96 MY POSITION SET	My position setting.	GPS / MANUAL
97 MY POSITION	My position manual setting.	LAT: N 0°00. 00' (° 00") LON: E 0°00. 00' (° 00")
98 MY SYMBOL	My symbol setting.	ICON 1: [/>] Car ICON 2: [/R] REC.Vehicle ICON 3: [/] House QTH (VHF) USER: [YY] Yaesu Radios
99 POSITION COMMENT	Set position comment.	Off Duty / En Route / In Service / Returning / Committed / Special / Priority / Custom 0 to Custom 6 / EMERGENCY!
100 SmartBeaconing	Smart beaconing settings.	STATUS: OFF / TYPE1 / TYPE2 / TYPE3 * For details on the following setting items for each type, refer to the APRS Instruction Manual. LOW SPEED, HIGH SPEED, SLOW RATE, FAST RATE, TURN ANGLE, TURN SLOPE, TURN TIME
101 SORT FILTER	Sort function / Filter function settings.	SORT: TIME / CALLSIGN / DISTANCE FILTER: ALL / MOBILE / FREQUENCY / OBJECT/ITEM / DIGIPEATER / VoIP / WEATHER / YAESU / OTHER PACKET / CALL RINGER / RANGE RINGER / 1200 bps / 9600 bps
102 VOICE ALERT	Voice alert function settings.	VOICE ALERT: NORMAL / TONE SQL DCS / RX-TSQL / RX-DCS TONE SQL: 67.0Hz - 100.0Hz - 254.1Hz DCS: 023 - 754
103 STATION LIST	Displays the APRS Station list screen.	—
104 MESSAGE LIST	Displays the APRS Message list screen.	—
105 BEACON TX SELECT	Beacon automatic transmit / Manual transmit switch.	MANUAL / AUTO / (SmartBeaconing)* * The option in the parentheses is avail- able when the "100 SmartBeaconing" is TYPE1, TYPE 2 or TYPE 3, and the "96 MY POSITION SET" is GPS.
106 BEACON TX	Manual beacon transmission (one time)	—

SD CARD

107 BACKUP

WRITE TO SD	Saves the transceiver setting information to a microSD memory card.
ALL MEMORY SETUP	Copies all data. Copies only the memory channels and backtrack position information. Copies only the set-up menu settings.

Menu Number / Item	Description	Selectable options (Options in bold are the default settings)
READ FROM SD	Loads the information to the transceiver from a microSD memory card.	
ALL MEMORY SETUP	Copies all data. Copies only the memory channels and backtrack position information. Copies only the set-up menu settings.	
108 MEMORY INFO	Displays the total capacity and free space of the MicroSD Card.	–
109 FORMAT	Initializing the micro-SD card.	–
110 JPG IMPORT	Converts JPEG images to QVGA size or smaller so that they can be displayed on the FTM-500DR/DE screen or sent as image data.	–

OPTION

111 Bluetooth		
Bluetooth	Bluetooth headset setting.	OFF / ON
DEVICE	Bluetooth device list.	–
STATUS	Display the connection status of Bluetooth devices.	–
AUDIO	Set whether received audio is heard from both the Bluetooth® headset and the transceiver speaker, or only from the connected Bluetooth® device.	AUTO / FIX
112 VOICE MEMORY (Requires optional Voice Guide Unit FVS-2)		
PLAY/REC	Recording operation settings.	FREE 5min / LAST 30sec
ANNOUNCE	Setting conditions for frequency announcement.	AUTO / OFF / MANUAL
LANGUAGE	Setting the language to announce.	ENGLISH / JAPANESE
VOLUME	Setting the announcement volume.	HIGH / MID / LOW
RX MUTE	Setting to mute received audio during announcements and playback.	ON / OFF
113 FVS REC	Start recording the received audio.	–
114 TRACK SELECT	Selecting the audio track to play.	ALL / 1 - 8
115 FVS PLAY	Start playing the recorded sound	–
116 FVS STOP	Stop recording / playing	–
117 FVS CLEAR	Erase all recorded audio	–
118 VOICE GUIDE	The frequency of the operating band will be announced.	–

CLONE

119 This → Other	Send all settings to other FTM-500D	–
120 Other → This	Receive all settings from other FTM-500D	–

RESET

121 CALLSIGN	My call sign setting. (10 characters)	*****
122 MEMORY CH RESET	Erase registered memory channels.	–
123 APRS RESET	Return APRS settings to default.	–
124 CONFIG SET	Save configuration.	–
125 CONFIG RECALL	Recall configuration.	–
126 SOFTWARE VERSION	Display the software version.	Main Ver. / Sub Ver. / DSP Ver.
127 FACTORY RESET	Return all settings to factory default.	–

Restoring to Defaults (Reset)

Caution

When the All Reset function is performed, all data registered in the memory will be deleted. Be sure to note the settings on paper or back up the data on a microSD memory card.

All Reset

To restore all transceiver settings and memory content to the factory defaults.

1. Press and hold the **FUNC** knob.
The SETUP MENU screen will be displayed.
2. Touch [127 FACTORY RESET].
Or rotate the the **FUNC** knob to select [127 FACTORY RESET], then press the **FUNC** knob.
“FACTORY RESET” appears on the LCD.
3. Touch [OK].
Or rotate the **FUNC** knob to select [OK].
To cancel the resetting, select [CANCEL], then press the **FUNC** knob.
4. Touch [OK] or press the **FUNC** knob to reset all.
After resetting all defaults, the call sign input message appears on the LCD. Set the call sign (page 4).

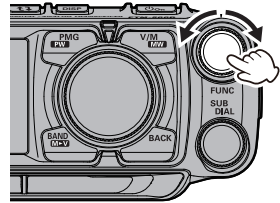

RESET	
124	CONFIG SET
125	CONFIG RECALL
126	SOFTWARE VERSION >
127	FACTORY RESET
>	

Memory Channels Reset

To erase only the registered all memory channels.

1. Press and hold the **FUNC** knob → select [122 MEMORY CH RESET] → Touch [122 MEMORY CH RESET].
“MEMORY RESET” appears on the LCD.
2. Touch [OK].
To cancel the resetting, touch [CANCEL].
3. Touch [OK] to delete all memory contents.

APRS Reset

To restore all APRS settings to the factory defaults.

1. Press and hold the **FUNC** knob → select [123 APRS RESET] → Touch [123 APRS RESET].
“APRS RESET” appears on the LCD.
2. Touch [OK].
To cancel the resetting, touch [CANCEL].
3. Touch [OK] to delete all **APRS** settings.

Text input screen

The keyboard screen is displayed when entering your own station call sign or memory channel tag.

● Character input method

1. Touch a character on the screen to enter it.
Or rotate the **FUNC** knob to select a character, then press the **FUNC** knob.
2. The selected character is entered and the cursor moves right in the text input area.
3. Repeat steps 1 to enter additional characters.
4. When input is complete, press and hold the **FUNC** knob to save the characters.

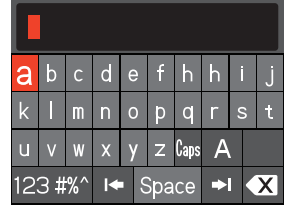

- Touch [←] or [→], or select [←] or [→], then press the **FUNC** knob to move the cursor left or right in the text input area.
- Touch [X], or select [X], then press the **FUNC** knob to erase the character at the left of the cursor position.
- Touch [Space], or select [Space], then press the **FUNC** knob to enter a space at the cursor position.

Alphabet Input

- Each time [A] or [ABC] is touched, or rotate the **FUNC** knob to select [A] or [ABC], and each time the **FUNC** knob is pressed, the input screen changes as follows:
- Each time [Caps] is touched, or rotate the **FUNC** knob to select [Caps], and each time the **FUNC** knob is pressed, the input switches between small and capital letters.

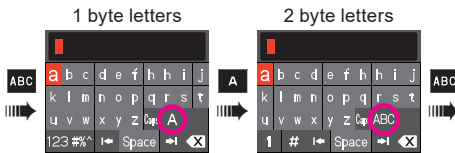

Numbers and Symbols Input

- Each time [1], [#], [#s%] or [123] is touched, or rotate the **FUNC** knob to select [1], [#], [#s%] or [123], and each time the **FUNC** knob is pressed, the input screen changes as follows:

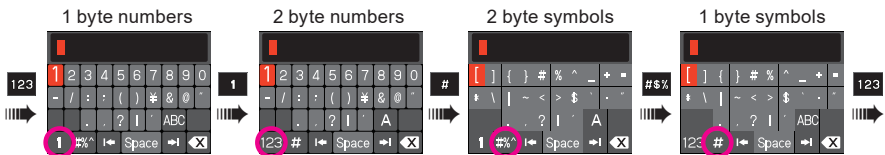

Specifications

● General

Frequency Range	: TX 144 - 148MHz or 144 - 146MHz 430 - 450MHz or 430 - 440MHz (Depends on the transceiver version)
	: RX 108 - 137MHz (AIR Band) 137 - 174MHz (144MHz HAM / VHF Band) 174 - 400MHz 400 - 480MHz (430MHz HAM / UHF Band) 480 - 999.995MHz (USA Cellular Blocked)
Channel Steps	: 5 / 6.25 / 8.33 / 10 / 12.5 / 15 / 20 / 25 / 50 / 100kHz (8.33kHz: only for Air band)
Mode of Emission	: F1D, F2D, F3E, F7W
Frequency Stability	: ± 2.5 ppm (-4°F to +140°F [-20°C to +60°C])
Antenna Impedance	: 50 Ω
Supply Voltage	: Nominal 13.8V DC, negative ground
Current Consumption (approx.)	: 0.5A (Receive) 10A (50W TX, 144MHz) 10A (50W TX, 430MHz)
Operating Temperature Range	: -4°F to +140°F (-20°C to +60°C)
Case Size (W x H x D)	: Radio unit 5.47" x 1.66" x 5.2" (139 x 42 x 132mm) (w/o Fan) Controller 6.14" x 2.52" x 2.31" (156 x 64 x 58.6mm) (w/o Knob)
Weight (approx.)	: 3.09lbs (1.4kg) (with Radio Unit, Controller, Control Cable)

● Transmitter

RF Power Output	: 50W / 25W / 5W
Modulation Type	: F1D, F2D, F3E: Variable Reactance Modulation F7W: 4FSK (C4FM)
Maximum Deviation	: ± 5 kHz
Spurious Emission	: At least 60dB below
Microphone Impedance	: 2k Ω
DATA Jack Impedance	: 10k Ω

● Receiver

Circuit Type	: Double-Conversion Super heterodyne
Intermediate Frequency	: 1st: MAIN Band 56.75MHz 1st: SUB Band 55.85MHz 2nd: MAIN Band, SUB Band 450kHz
Sensitivity	: 0.8 μ V typ for 10dB SN (108 - 137MHz, @AM) 0.2 μ V for 12dB SINAD (137 - 150MHz, @FM) 0.25 μ V for 12dB SINAD (150 - 174MHz, @FM) 0.3 μ V typ for 12dB SINAD (174 - 222MHz, @FM) 0.25 μ V typ for 12dB SINAD (222 - 300MHz, @FM) 0.8 μ V typ for 10dB SN (300 - 336MHz, @AM) 0.25 μ V typ for 12dB SINAD (336 - 420MHz, @FM) 0.2 μ V for 12dB SINAD (420 - 470MHz, @FM) 0.2 μ V typ for 12dB SINAD (470 - 540MHz, @FM) 0.8 μ V typ for 12dB SINAD (540 - 800MHz, @FM) 0.4 μ V typ for 12dB SINAD (800 - 900MHz, @FM) 0.8 μ V typ for 12dB SINAD (900 - 999.99MHz, @FM) 0.19 μ V typ for BER 1% (Digital Mode) Cellular Blocked (USA only)
Selectivity (-6 dB/-60 dB)	: NFM, AM 12 kHz / 30 kHz
AF Output	: 6W (8 Ω , THD10%, 13.8 V) Front Speaker 3W (8 Ω , THD10%, 13.8 V) Internal Speaker 3W (8 Ω , THD10%, 13.8 V) External Speaker
AF Output Impedance	: 8 Ω
Strength of secondary radio waves:	4 nW and below

● Bluetooth

Version	: Version 5.0
Class	: Class 1

Specifications are subject to change without notice, and are guaranteed within the 144/430 MHz amateur bands only.

The Bluetooth® wordmark and logo are registered trademarks owned by Bluetooth SIG, Inc. and are used under license by Yaesu Musen Co., Ltd.

About internal spurious signals

Certain frequency combinations of signals received simultaneously, may cause some effect on the receiver mixer and IF circuits due to the high frequency of the internal oscillator. However, this is not a malfunction (refer to the calculation formulas below: n is any integer). Depending on the combination of the frequencies received at the same time, there may also be fluctuations in the receiver sensitivity.

- Reception frequency = 16MHz x n times
- Reception frequency = 12MHz x n times
- Reception frequency = 56.3MHz x n times
- Reception frequency = 45.9MHz x n times
- Reception frequency = 19.2MHz x n times
- Upper (MAIN Band) frequency = (Lower (SUB Band) frequency \pm 55.85MHz) x n times
- Lower (SUB Band) frequency = (Upper (MAIN Band) frequency \pm 56.75MHz) x n times

YAESU LIMITED WARRANTY

Limited Warranty is valid only in the country/region where this product was originally purchased.

On-line Warranty Registration:

Thank you for buying YAESU products! We are confident your new radio will serve your needs for many years! Please register your product at www.yaesu.com - Owner's Corner

Warranty Terms:

Subject to the Limitations of the Warranty and the Warranty Procedures described below, YAESU MUSEN hereby warrants this product to be free of defects in materials and workmanship in normal use during the "Warranty Period." (the "Limited Warranty").

Limitations of Warranty:

- A. YAESU MUSEN is not liable for any express warranties except the Limited Warranty described above.
- B. The Limited Warranty is extended only to the original end-use purchaser or the person receiving this product as a gift, and shall not be extended to any other person or transferee.
- C. Unless a different warranty period is stated with this YAESU product, the Warranty Period is three years from the date of retail purchase by the original end-use purchaser.
- D. The Limited Warranty is valid only in the country/region where this product was originally purchased.
- E. During the Warranty Period, YAESU MUSEN will, at its sole option, repair or replace (using new or refurbished replacement parts) any defective parts within a reasonable period of time and free of charge.
- F. The Limited Warranty does not cover shipping cost (including transportation and insurance) from you to us, or any import fees, duties or taxes.
- G. The Limited Warranty does not cover any impairment caused by tampering, misuse, failure to follow instructions supplied with the product, unauthorized modifications, or damage to this product for any reasons, such as: accident; excess moisture; lightning; power surges; connection to improper voltage supply; damage caused by inadequate packing or shipping procedures; loss of, damage to or corruption of stored data; product modification to enable operation in another country/purpose other than the country/purpose for which it was designed, manufactured, approved and/or authorized; or the repair of products damaged by these modifications.
- H. The Limited Warranty applies only to the product as it existed at the time of the original purchase, by the original retail purchaser, and shall not preclude YAESU MUSEN from later making any changes in design, adding to, or otherwise improving subsequent versions of this product, or impose upon YAESU MUSEN any obligation to modify or alter this product to conform to such changes, or improvements.
- I. YAESU MUSEN assumes no responsibility for any consequential damages caused by, or arising out of, any such defect in materials or workmanship.
- J. TO THE FULLEST EXTENT PERMITTED BY LAW, YAESU MUSEN SHALL NOT BE RESPONSIBLE FOR ANY IMPLIED WARRANTY WITH RESPECT TO THIS PRODUCT.
- K. If the original retail purchaser timely complies with the Warranty Procedures described below, and YAESU MUSEN elects to send the purchaser a replacement product rather than repair the "original product", then the Limited Warranty shall apply to the replacement product only for the remainder of the original product Warranty Period.
- L. Warranty statutes vary from state to state, or country to country, so some of the above limitations may not apply to your location.

Warranty Procedures:

1. To find the Authorized YAESU Service Center in your country/region, visit www.yaesu.com. Contact the YAESU Service Center for specific return and shipping instructions, or contact an authorized YAESU dealer/distributor from whom the product was originally purchased.
2. Include proof of original purchase from an authorized YAESU dealer/distributor, and ship the product, freight prepaid, to the address provided by the YAESU Service Center in your country/region.
3. Upon receipt of this product, returned in accordance with the procedures described above, by the YAESU Authorized Service Center, all reasonable efforts will be expended by YAESU MUSEN to cause this product to conform to its original specifications. YAESU MUSEN will return the repaired product (or a replacement product) free of charge to the original purchaser. The decision to repair or replace this product is the sole discretion of YAESU MUSEN.

Other conditions:

YAESU MUSEN'S MAXIMUM LIABILITY SHALL NOT EXCEED THE ACTUAL PURCHASE PRICE PAID FOR THE PRODUCT. IN NO EVENT SHALL YAESU MUSEN BE LIABLE FOR LOSS OF, DAMAGE TO OR CORRUPTION OF STORED DATA, OR FOR SPECIAL, INCIDENTAL, CONSEQUENTIAL, OR INDIRECT DAMAGES, HOW EVER CAUSED; INCLUDING WITHOUT LIMITATION TO THE REPLACEMENT OF EQUIPMENT AND PROPERTY, AND ANY COSTS OF RECOVERING, PROGRAMMING OR REPRODUCING ANY PROGRAM OR DATA STORED IN OR USED WITH THE YAESU PRODUCT.

Some Countries in Europe and some States of the USA do not allow the exclusion or limitation of incidental or consequential damages, or a limitation on how long an implied warranty lasts, so the above limitation or exclusions may not apply. This warranty provides specific rights, there may be other rights available which may vary between countries in Europe or from state to state within the USA.

This Limited Warranty is void if the label bearing the serial number has been removed or defaced.

Changes or modifications to this device that are not expressly approved by YAESU MUSEN could void the user's authorization to operate this device.

This device complies with part 15 of the FCC Rules. Operation is subject to the following two conditions: (1) This device may not cause harmful interference, and (2) this device must accept any interference including received, interference that may cause undesired operation.

The scanning receiver in this equipment is incapable of tuning, or readily being altered, by the User to operate within the frequency bands allocated to the Domestic public Cellular Telecommunications Service in Part 22.

The YAESU MUSEN is not responsible for any changes or modifications not expressly approved by the party responsible for compliance. Such modifications could void the user's authority to operate the equipment.

This device complies with ISED's applicable license-exempt RSS standard(s). Operation is subject to the following two conditions: (1) this device may not cause interference, and (2) this device must accept any interference, including interference that may cause undesired operation of the device.

Le présent appareil est conforme aux CNR d'Industrie Canada applicables aux appareils radio exempts de licence. L'exploitation est autorisée aux deux conditions suivantes : (1) l'appareil ne doit pas produire de brouillage, et (2) l'utilisateur de l'appareil doit accepter tout brouillage radioélectrique subi, même si le brouillage est susceptible d'en compromettre le fonctionnement.

DECLARATION BY MANUFACTURER

The Scanner receiver is not a digital scanner and is incapable of being converted or modified to a digital scanner receiver by any user.

WARNING: MODIFICATION OF THIS DEVICE TO RECEIVE CELLULAR RADIOTELEPHONE SERVICE SIGNALS IS PROHIBITED UNDER FCC RULES AND FEDERAL LAW.

CAN ICES-3 (B) / NMB-3 (B)

This equipment has been tested and found to comply with the limits for a Class B digital device, pursuant to part 15 of the FCC Rules. These limits are designed to provide reasonable protection against harmful interference in a residential installation. This equipment generates, uses, and can radiate radio frequency energy; and, if not installed and used in accordance with the instructions, may cause harmful interference to radio communications. However, there is no guarantee that interference will not occur in a particular installation.

If this equipment does cause harmful interference to radio or television reception, which can be determined by turning the equipment off and on, the user is encouraged to try to correct the interference by one or more of the following measures:

- Reorient or relocate the receiving antenna.
- Increase the separation between the equipment and receiver.
- Connect the equipment into an outlet on a circuit different from that to which the receiver is connected.
- Consult the dealer or an experienced radio/TV technician for help.

This equipment complies with FCC/IC radiation exposure limits and meets the FCC radio frequency (RF) Exposure Guidelines and RSS-102 of the IC radio frequency (RF) Exposure rules. This equipment has very low levels of RF energy that is deemed to comply without testing of specific absorption rate (SAR).

This transmitter must not be co-located or operated in conjunction with any other antenna or transmitter.

YAESU

Declaration of Conformity

Type of Equipment: 144/430MHz Digital/Analog Transceiver
Brand Name: YAESU
Model Number: FTM-500DR
Manufacturer: YAESU MUSEN CO., LTD.
Address of Manufacturer: Omori Bellport Building D-3F
6-26-3 Minami-Oi, Shinagawa-ku, Tokyo, 140-0013, Japan

This device complies with part 15 of the FCC Rules. Operation is subject to the following two conditions; (1) this device may not cause harmful interference, and (2) this device must accept any interference received, including interference that may cause undesired operation.

The technical documentation as required by the Conformity Assessment procedures is kept at the following address:

Company: Yaesu U.S.A.
Address: 6125 Phyllis Drive, Cypress, CA 90630, U.S.A.
Telephone: (714) 827-7600

EU Declaration of Conformity

We, Yaesu Musen Co. Ltd of Tokyo, Japan, hereby declare that this radio equipment FTM-500DE is in full compliance with EU Radio Equipment Directive 2014/53/EU. The full text of the Declaration of Conformity for this product is available to view at <http://www.yaesu.com/jp/red>

ATTENTION – Condition of use

This transceiver operates on frequencies that are regulated. Use of the Transmitter in the EU countries shown in the accompanying table is not permitted without authorization. Users should consult their local spectrum management authority for licensing conditions applicable to this equipment.

					
AT	BE	BG	CY	CZ	DE
DK	ES	EE	FI	FR	EL
HR	HU	IE	IT	LT	LU
LV	MT	NL	PL	PT	RO
SK	SI	SE	CH	IS	LI
NO	–	–	–	–	–

Disposal of Electronic and Electrical Equipment

Products with the symbol (crossed-out wheeled bin) cannot be disposed as household waste.

Electronic and Electrical Equipment should be recycled at a facility capable of handling these items and their waste by-products.

Please contact a local equipment supplier representative or service center for information about the waste collection system in your country.



UKCA Declaration of Conformity

We, Yaesu Musen Co. Ltd of Tokyo, Japan declare our sole responsibility that this equipment complies with essential requirements of the Radio Equipment Regulations 2017, Electrical Equipment (Safety Regulations 2016), Electromagnetic Compliance Regulations 2016 and Restrictions of the use of Certain Hazardous Substances in Electrical and Electronic Equipment Regulations 2012 as appropriate.

YAESU

Radio for Professionals

Copyright 2023
YAESU MUSEN CO., LTD.
All rights reserved.

No portion of this manual may be
reproduced without the permission of
YAESU MUSEN CO., LTD.

YAESU MUSEN CO., LTD.

Omori Bellport Building D-3F
6-26-3 Minami-Oi, Shinagawa-ku, Tokyo, 140-0013, Japan

YAESU USA

6125 Phyllis Drive, Cypress, CA 90630, U.S.A.

YAESU UK

Unit 12, Sun Valley Business Park, Winnall Close
Winchester, Hampshire, SO23 0LB, U.K.

2308V-ES-1

Printed in Japan

